

**Pollié**   
*Pensando en el profesional*

 **TASSEL**  
SKIN COSMETICS

## **Spécial Esthétique** **Especial Estética**

**Sans Prix / Sem Preços**

**ANDREA**  
Pestañas

**BEAUTENE**

**maniquick**  
Quality Treatment & Innovation

**MEDISANA**

**promed**



## 01 Ligne de soins facial Linha de cuidados faciais 4

Nettoyage et préparation de la peau ..... 5	
<i>Limpeza e preparação do piel</i>	
Crèmes et traitements, huiles essentielles ..... 8	
<i>Creme e tratamentos, óleos essenciais</i>	
Vapor facial et accessoires · Vapor facial e acessórios ..... 23	

## 02 Ligne de soins corps Linha de cuidados corpo 26

Crèmes et traitements, huiles de base ..... 27	
<i>Creme e tratamentos, óleos base</i>	
Accessoires · Acessórios ..... 35	

## 03 Épilaton Depilação 36

Cire Kg · Cera Kg ..... 37	
Accessoires cire · Acessórios cera ..... 48	
Roll-on cire · Roll-on cera ..... 50	
Accessoires Roll-on cire · Acessórios Roll-on cera ..... 54	
Accessoires épilation · Acessórios depilação ..... 57	
Pinces à épiler · Pinças de depilar ..... 66	

## 04 Manucure y pédicure Manicure e pedicure 72

Vernis à ongles Pollié · Esmalte de unhas Pollié ..... 73	
Vernis à ongles semi-permanent P-Lack ..... 80	
<i>Esmalte de unhas semipermanente P-LACK</i>	
Acrylique gel · Gel acrílico ..... 82	
Dissolvant et crème mains ..... 84	
<i>Removedor e creme para as mãos</i>	
Pinceaux à ongles acryliques · Pincéis unhas acrílicas ..... 87	
Accessoires NAIL ART · Accesorios NAIL ART ..... 89	
Lampe UV led · Catalisador de unhas Uv Led ..... 99	
Paraffine · Parafina ..... 105	
Ponceuse à ongles · Brocas ..... 107	
Lampe · Lupa ..... 116	
Limes et blocs polissage · Limas e blocos ..... 118	
Stérilisateurs · Esterilizador ..... 135	
Pinces coupe-cuticules · Alicates corta cutículas ..... 137	
Pinces coupe ongles · Corta unhas ..... 142	
Poussoir pour cuticules · Empurrador de cutículas ..... 146	
Accessoires manucure · Accesorios manicure ..... 147	
Ciseaux à peaus et ongles · Tesouras peles e unhas ..... 148	
Bâtons de buis qui servent à pousser les cuticules ..... 150	
<i>Removedor de peles</i>	
Pécifique pédicure · Specific pedicure ..... 151	

## 05 Maquillage Maquiagem 162

Crayons/mascara pour recourber les cils ..... 163	
<i>Lápis/mascara de pestanhas</i>	
Éponges démaquiller · Desmaquiagem esponja ..... 168	
Éponges pour maquiller · Esponjas maquiagem ..... 169	
Pinceau de maquillage/brosse ..... 173	
<i>Pincel de maquiagem/escobas de maquiagem</i>	

## 06 Faux-cils Pestanas 188

Faux-cils Pollié · Pestanas Pollié ..... 189	
Faux-cils Andrea · Pestanas Andrea ..... 195	
Kit Faux-cils ..... 197	
<i>Kit pestanas</i>	
Présentoir, dissolvant d'adhésif faux-cils, accessoires ..... 199	
<i>Expositor, dissolvente adesivo pestanas, acessórios</i>	
Sourcils · Sobrancelhas ..... 201	

## 07 Accessoires et hygiène Acessórios e higiene 202

Dans papier pour table esthétique ..... 203	
<i>Papel para marquesa</i>	
Draps et couvertures, serviettes ..... 204	
<i>Manta, lençois, toalhas</i>	
Protecteurs et gants · Protetores e luvas ..... 207	
Jetables · Utilização única ..... 211	
Coton · Algodão ..... 218	
Miroirs · Espelhos ..... 219	
Masques faciaux · Máscaras faciais ..... 226	
Vêtement LACLA · Vestuário LACLA ..... 228	
Anneau lumineux à led · Led anelar ..... 234	
Valises · Molas ..... 236	
Pulvérisateur · Pulverizador ..... 242	
Protecteurs UV · Protetores UV ..... 243	
Articles d'hygiène et désinfectante ..... 244	
<i>Artigos higiene e desinfectante</i>	

## 08 Mobilier Mobiliário 248

Tables de massage · Marquesa ..... 249	
Table de manucure · Mesa manicure ..... 254	
Chariot manucure/pédicure ..... 255	
<i>Carrinho manicure/pedicure</i>	
Tabouret, support, chaise ..... 258	
<i>Banco, suporte, cadeira</i>	
Valises, chaise maquillage ..... 263	
<i>Mala/Tocador, assento maquiagem</i>	



Les prix indiqués dans ce catalogue sont des prix recommandés, taxes en sus.  
Les prix seront valables sauf erreurs typographiques.  
Industrias Oriol 1942, S.L. se réserve le droit d'apporter des modifications sans préavis.

*Os preços listados neste catálogo são preços recomendados, impostos não incluídos.  
Os preços serão válidos, exceto por erros tipográficos.  
Industrias Oriol 1942, S.L. reserva-se o direito de fazer modificações sem aviso prévio.*



01

## Ligne de soins facial Linha de cuidados faciais

*Nettoyage et préparation de la peau, crèmes  
et traitements, présents, accessoires...*

*Limpeza e preparação da pele, cremes  
e tratamentos, expositores, acessórios ...*







## Eau micellaire vs lait démaquillant Água micelar vs leite de limpeza



Pour un bon nettoyage du visage, un lait nettoyant qui élimine toute la saleté et un tonique qui nettoie les cellules mortes tout en vous aidant à vous débarrasser de vos pores dilatés et les points noirs. Le tonique et Lait démaquillant Tassel contiennent de huile à l'azulène qui régule et traite vos problèmes de peau sensible. Vous pouvez également utiliser l'eau micellaire pour gagner du temps dans le processus de nettoyage ,c'est un produit doux pour la peau. Plusieurs options pour nettoyer votre peau. Choisissez votre produit!

Para uma boa limpeza facial é fundamental um leite de limpeza que lave todas as impurezas um tónico que limpe os restos, e ao mesmo tempo desinfete e feche os poros. O tónico e o leite de limpeza Tassel contêm azuleno que é o mais indicado para peles sensíveis. Também pode utilizar a água Micelar que poupa passos no processo de limpeza e é delicado com a pele. Tem várias opções para limpar a pele. Escolha o seu produto!

### Lait démaquillant Leite de limpeza



u.m.vta: 1  12 

500 ml

REF.07094



### Tonique revitalisant Tónico revitalizante

u.m.vta: 1  12 

500 ml

REF.07095



#### Huile d'argan et Aloe Vera

L'utilisation de lait démaquillant permet d'éliminer les impuretés et les traces de saleté accumulées sur la peau. De cette façon, la peau est oxygénée et semble plus lumineuse et saine. Avec la formule à l'huile d'azulène élimine les résidus de cire. Non gasse, elle apaise et hydrate votre peau sensible, pour la laisser douce et veloutée. D'usage quotidien.

#### Azeite de Argão e Aloé Vera.

A utilização do leite de limpeza ajuda a eliminar as impurezas e restos de sujidade acumulados na pele. Desta forma, a pele é oxigenada tornando-a mais luminosa e saudável. Com azuleno para peles sensíveis, não oleosa. De uso diário.



#### Huile d'argan et Aloe Vera

L'utilisation du tonique facial agit comme un équilibrant après le nettoyage avec le lait démaquillant, c'est l'étape définitive pour le compléter. Apporte fraîcheur et vitalité à la peau avec l'huile à l'azulène qui est idéale pour les peaux sensibles. Usage quotidien.

#### Azeite de Argão e Aloé Vera.

O uso do tónico facial permite o equilibrio da pele após a utilização do leite de limpeza, é o último passo para completar a limpeza. Proporciona frescura e vitalidade à pele. Com azuleno, ideal para peles sensíveis. Uso diário.

## Visage exfoliant Exfoliante facial



u.m.vta: 1  15 

100 ml

REF.06071



## Eau micellaire Água micelar

u.m.vta: 1  9 

400 ml

REF.04206



### Natural Mineral comme exfoliant

L'huile d'argan et l'Aloe Vera ont des propriétés restructurantes et régénérantes. L'actif minéral naturel a de grandes propriétés d'exfoliation. Enlever et traîner les cellules mortes sans endommager la peau en la laissant propre, douce, lumineuse et avec une grande capacité respiratoire favorisant l'absorption de tout traitement de beauté. Il peut être utilisé comme un gommage facial régulier.

### Mineral Natural como um esfoliante

O óleo de argão e Aloe Vera, tem propriedades de reestruturação e regeneração. O ativo Mineral Natural possui ótimas propriedades de esfoliação. Retire e arraste as células mortas sem danificar a pele deixando-a limpa, suave, luminosa e com grande capacidade respiratória favorecendo a absorção de qualquer tratamento de beleza. Pode ser usado como um esfoliante facial regular.



### Nettoie, tonifie et hydrate

Eau micellaire 3 en 1. Nettoie, démaquille et élimine les impuretés de la peau sans rinçage. Tout en respectant l'équilibre hydrique et le pH de la peau, la laissant propre et douce. Efficace avec le maquillage le plus résistant. Arôme doux de roses.

### Limpa, tonifica e hidrata

Água micelar 3 em 1. Limpa, desmaquilha e elimina impurezas da pele sem necessidade de lavar. Respeitando o equilíbrio hidrico e Ph da pele deixando-a limpa e suave. Eficaz com a maquiagem mais resistente. Suave aroma a rosas.

## Black mask nettoyage en profondeur Black mask limpeza profunda

u.m.vta: 1  12 

50 ml

REF.04580

### Black Masque "peel off":

Produit fabriqué spécialement sur la base d'une formule douce et efficace, contenant du charbon actif, de l'aloès vera, de l'avoine et de la glycérine végétale. Il permet de nettoyer en profondeur les impuretés de la peau, sans aucun type de dommage ou d'agression.

### Máscara peel-off:

Produto elaborado especialmente com uma fórmula suave e eficaz, contem Carvão Ativo, Aloe Vera, Aveia e Glicerina Vegetal. Permite limpar profundamente as impurezas da pele, sem qualquer tipo de dano ou agressão.



SCAN ME!





**TASSEL SKIN COSMETICS, lance la gamme HYALURONIC sur le marché**  
**TASSEL SKIN COSMETICS, lança a linha HYALURONIC no mercado**

L'acide hyaluronique est un composant structurel de la matrice extracellulaire de la peau qui, avec le collagène et les fibres élastiques, forme la structure du derme cutané et est responsable de l'hydratation de la peau. Un manque d'hydratation peut produire des effets contre-productifs sur notre derme et notre épiderme, rendant la peau plus sensible aux facteurs qui accélèrent le vieillissement.

O ácido hialurônico é um componente estrutural da matriz extracelular da pele que, juntamente com o colágeno e as fibras elásticas, formam a estrutura da derme dérmica e é responsável por manter a pele hidratada. A falta de hidratação pode produzir efeitos contraproducentes em nossa derme e epiderme, tornando a pele mais sensível a fatores que aceleram o envelhecimento.



**Présentoir hyaluronic (en cadeau)**  
**Expositor hyaluronic (de oferta)**

u.m.vta: 1  1

**REF.07800**

Il inclue 2 Crèmes à l'acide hyaluronique réf. 06798 + 2 sérums à l'acide hyaluronique réf. 06799.

Inclui 2 Cremes de ácido hialurônico ref. 06798 y + 2 sérums de ácido hialurônico ref. 06799.



## Crème hyaluronique

### Creme hialurônico

u.m.vta: 1



24



50 ml

REF.06798



Spécifique pour les peaux déshydratées. De par sa composition, il redensifie la peau en réduisant immédiatement la profondeur des rides. Combattez les lignes d'expression. Utilisation quotidienne.

#### Propriétés:

- Très hydratante et humidifiante
- Améliore visiblement la barrière lipidique de la peau
- Stimule la régénération des cellules de la peau
- Adoucit les rides d'expression, réduisant la profondeur des rides
- Comble les ridules et les rides de la peau

**Application:** Appliquer sur la peau propre tant sur la zone du visage, que le cou et le décolleté avec des massages circulaires doux, jusqu'à absorption complète. Elle peut être appliquée jour et nuit selon les besoins de la peau.

*Específico para a pele desidratada. Gaças à sua composição, redensifica a pele imediatamente, reduzindo a profundidade das rugas. Lute contra as linhas de expressão. Uso diário.*

#### Propiedades:

- Altamente hidratante
- Melhora visivelmente a barreira lipídica da pele
- Estimula a regeneração das células da pele
- Suaviza as linhas de expressão, reduzindo a profundidade das rugas
- Preenche as linhas finas e as rugas da pele

**Aplicação:** Aplicar na pele limpa, área facial, pescoço e decote, com massagens circulares suaves, até completa absorção. Pode ser aplicado dia e noite, dependendo da necessidade da pele.

## Sérum concentré hyaluronique

### Soro concentrado hialurônico

u.m.vta: 1



12



30 ml

REF.06799

Comblement des rides. Effet anti-âge, neutralise les effets du passage du temps, laissant la peau plus hydratée, élastique et lumineuse.

C'est un sérum à haute concentration d'acide hyaluronique qui aide à réhydrater la peau et à prévenir la perte d'eau, tout en renforçant ses défenses et en améliorant considérablement son volume, sa fermeté et sa douceur.

**Application:** Appliquer matin et soir avant la crème hydratante, sur la peau du visage, du cou et du décolleté propres et secs. Masser jusqu'à absorption complète.

*Efeito antienvelhecimento, neutraliza os efeitos da passagem do tempo, deixando a pele mais hidratada, elástica e luminosa. É um soro com uma alta concentração de ácido hialurônico que ajuda a reidratar a pele e evitar a perda de água, fortalecendo suas defesas e melhorando muito seu volume, firmeza e suavidade.*

**Aplicação:** Aplicar de manhã e à noite, antes do hidratante, área facial, pescoço e decote, limpa e seca. Massagem até completa absorção.





## Crème hydratante de jour



### Creme hidratante de dia

u.m.vta: 1  1200

3 ml

REF.06653

Nouvelle  
formule  
Nova  
fórmula

u.m.vta: 1  24 

50 ml

REF.06451

200 ml

REF.07184

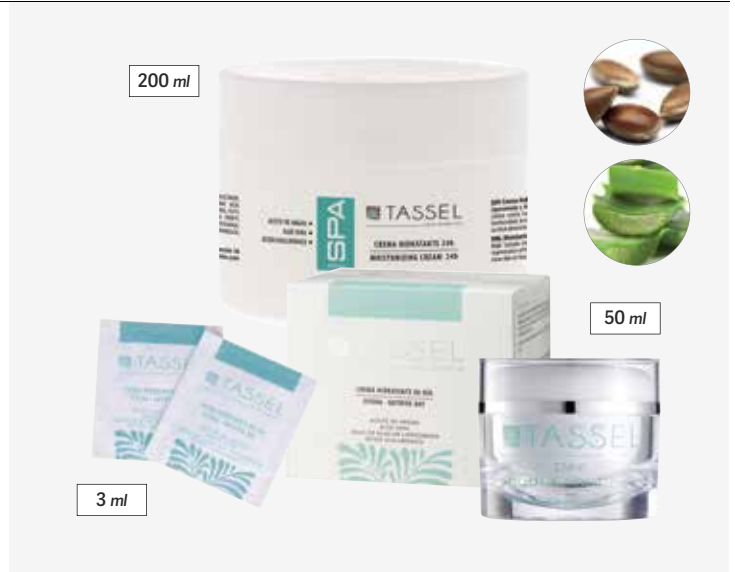

## Huile d'argan et Aloe Vera

Traitement hydro-nutritif qui stimule et restabilise les mécanismes de la peau. Gaças aos seus ativos: eau glacée lipossative, acide hyaluronique, céramides, aloès vera et huile d'argan, restaure la barreira da pele, un lipide naturel, en évitant la perte d'eau transépidermique (TWEL). Melhora a suavidade, equilíbrio de l'eau et flexibilidade da pele.

## Azeite de Argão e Aloé Vera

Tratamento hidro-nutritivo que estimula e restabelece os mecanismos da pele. Gaças aos seus ativos: Água Glacial Lipossomática, Ácido Hialurônico, Ceramidas, Aloe Vera e Óleo de Argan, restaura a barreira lipídica natural da pele, evitando a perda de água transepidermica (TWEL). Melhora a suavidade, equilíbrio de água e flexibilidade da pele.

## Crème nutritive de nuit

### Creme de noite nutritivo

u.m.vta: 1  1000

3 ml

REF.07297

u.m.vta: 1  24 

50 ml

REF.03541

200 ml

REF.07437



## Huile d'argan et à l'aloé vera

Crème hydratante enrichie à l'huile d'argan et à l'aloé vera. Indiqué pour tous les types de peau. Ses principes actifs stimulent la capacité cellulaire contre les radicaux libres et aident à la régénération du derme. Apporte luminosité, douceur et fermeté à la peau. Absorption rapide Appliquer quotidiennement de préférence la nuit.

## Óleo de Argan e Aloe Vera

Creme hidratante enriquecido com Óleo de Argan e Aloe Vera. Indicado para todos os tipos de pele. Seus princípios ativos estimulam a capacidade celular contra os radicais livres e ajudam na regeneração da derme. Traz luminosidade, maciez e firmeza à pele. Absorção rápida Aplicar diariamente de preferência à noite.



## Crème nutritive caviar

### Crema de noite caviar

u.m.vta: 1  1200

3 ml

REF.06654

u.m.vta: 1  18 

50 ml

REF.03543

u.m.vta: 1  12 

200 ml

REF.06452

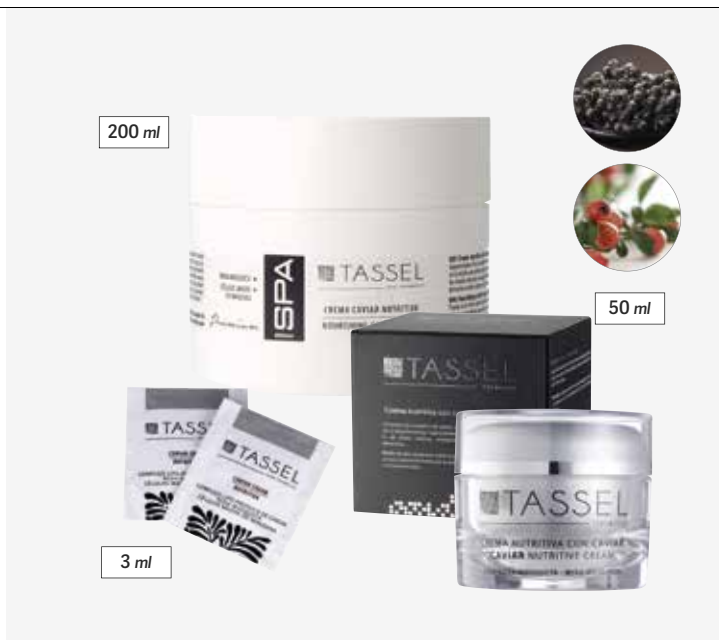



Indiqué pour les peaux matures. Crème à haute puissance pour vous régénérer. Préviend et adoucit les signes du vieillissement et ceux causés par les agressions extérieures. À utiliser de préférence deux fois par jour.

Indicado para peles maduras. Crema altamente regenerador. Previne e suaviza os sinais de envelhecimento causados pelas agressões externas. Recomendamos utilizar duas vezes por dia.

## Crème E-Pigment dépigmentant

### Crema E-Pigment despigmentação

u.m.vta: 1  24 

50 ml

REF.06800

Essentiellement conçue pour agir sur les zones plus foncées du visage, elle aide à freiner la production de mélanine et stimule la génération de nouvelles cellules qui renouvellent la peau, afin de retrouver son teint naturel. Enrichie en extraits de Réglisse, acide kojique et alpha-hydroxyacides.

- Elle éclaircit et réduit l'intensité des taches.
- Elle augmente la luminosité et homogénéise la couleur de la peau.
- Elle améliore l'hydratation et la fonction barrière de la peau
- Elle protège la peau des effets néfastes du soleil et prévient l'apparition des taches.

Essencialmente formulada para atuar sobre as zonas mais escuras do rosto, ajudando a travar a produção de melanina e estimulando a geração de novas células que renovam a pele, recuperando assim o seu tom habitual. Enriquecido com Glycyrrhiza glabra root extract, Kojic acid, alfa hidroxiácidos.

- Aclara e reduz a intensidade das manchas
- Aumenta a luminosidade e homogeniza o tom da pele
- Melhora a hidratação e a função barreira da pele
- Protege a pele do dano solar e previne o aparecimento de manchas







## Crème hydratant d'or Crema hidratante de ouro

u.m.vta: 1  1200



3 ml

REF.06655

u.m.vta: 1  18 

50 ml

REF.04980

u.m.vta: 1  24 

200 ml

REF.07185



### Or et Rose musquée

Indiqué pour les peaux matures, usage quotidien. Les oligo-éléments naturels stimulent la capacité cellulaire contre les radicaux libres, favorisent la régénération du derme, agissent contre la flaccidité et apportent luminosité, fermeté et fermeté à la peau.

Émulsifiant à la pointe de la technologie: Émulsifiant non ionique, naturel et sans PEG. Cliniquement prouvé, il possède d'importantes propriétés hydratantes et améliore visiblement la texture de la peau.

**Or:** Renforce la luminosité (idéal pour les peaux ternes et très foncées) a également un effet tenseur et régénérant: une peau visiblement plus jeune

**Argirelox:** Ce peptide est un ingrédient actif qui combat les rides d'expression en atténuant la contraction musculaire dans la voie pré-synaptique

**Pollushield:** ingrédient fonctionnel qui agit comme une barrière entre la peau et les contaminants dans l'environnement et augmente également le potentiel antioxydant de la peau

**Rose musquée:** Anti-rides naturelles qui favorisent la production de collagène, d'élastine et d'acide hyaluronique, qui donnent de la fermeté et de l'élasticité à la peau

### Ouro e rosa mosqueta

Indicado para pele madura, uso diário. Os oligoelementos naturais estimulam a capacidade celular na regeneração da derme, agem contra a flacidez e trazem luminosidade e firmeza à pele.

Emulsionante de última geração: Emulsionante não iônico, natural sem de PEG. Clinicamente comprovado, possui propriedades hidratantes significativas e melhora visivelmente a textura da pele.

**Ouro:** Reforça a luminosidade (ideal para pele opaca e muito escura) também tem um efeito tensor e regenerador: pele visivelmente mais jovem.

**Argirelox:** Este peptídeo é um ingrediente ativo que combate rugas de expressão atenuando a contração muscular na via pré-sináptica.

**Pollushield:** Ingrediente funcional que atua como uma barreira entre a pele e contaminantes no ambiente e também aumenta o potencial antioxidante da pele.

**Rosa Mosqueta:** Natural anti-rugas que promove a produção de colágeno, elastina e ácido hialurônico, que dão firmeza e elasticidade à pele.

**Cellules actives · anti âge · cellules souches végétales**  
**Celulas activas – anti-envelhecimento · células estaminais vegetais**



L'extrait de cellules souches d'origine végétale prévient et ralentit le vieillissement prématuré. Il aide à stimuler la régénération du tissu cutané, en fournissant la fermeté, l'élasticité et en atténuant les taches et les rides produites par le passage du temps. Sérum rapidement absorbé par sa texture légère. Appliquez le sérum avant la crème et utilisez les deux produits pour un résultat plus efficace.

**Propriétés:**

Anti-yeillissement et anti-âge en ralentissant le processus de vieillissement et en stimulant la régénération cellulaire dans le tissu cutané

Réparation des effets nocifs de l'environnement, en particulier la pollution et les rayons UV

*O extrato das Células Estaminais de Origem Vegetal previne e retarda o envelhecimento prematuro. Ajuda a estimular a regeneração do tecido cutâneo, proporcionando-lhe firmeza, elasticidade e atenua as manchas e rugas produzidas pela passagem do tempo. Rápida absorção pela sua textura leve. Aplicar o sérum antes do creme, utilizar ambos produtos para um resultado mais eficaz.*

**Propriedades:**

*Antienvhecimento ao retardar o processo de envelhecimento e estimular a regeneração celular no tecido cutâneo. Reparação dos efeitos nocivos do meio ambiente, especialmente da poluição e da radiação UV*

**Présentoir pour Tassel Active Cells**  
**Exibição de Tassel Active Cells**

u.m.vta: 1  1

**REF.03926**

Présentoir composé de:

- 5 crèmes actives · cellular anti-âge des cellules souches végétales
- 5 sérums actifs · cellular anti-âge des cellules souches végétales

Pack composto por:



- 5 cremes active · cells Anti-Idade de Células Estaminais Vegetais
- 5 sérums active · cells Anti-Idade de Células Estaminais Vegetais





## Crème

### Creme

u.m.vta: 1  1200u.m.vta: 1  24 

3 ml

50 ml

REF.06656

REF.03702





Indiquée pour les peaux matures. Appliquer la nuit. Adaptée à une utilisation quotidienne.

Indicada para peles maduras. Aplicar à noite, de uso diário.

## Sérum

### Sérum

u.m.vta: 1  6 

30 ml

REF.03703

Un sérum d'absorption rapide grâce à sa texture légère. Appliquer le matin. Adapté à une utilisation quotidienne

Rápida absorção graças à sua textura leve. Aplicar de manhã. Uso diário





**Présentoir pour la ligne professionnelle Tassel**  
**Exibição de linha profissional Tassel**

u.m.vta: 1		1
------------	---	---

**REF.04664**

Présentoir pour les crèmes composé de:



- 3 crèmes de jour Hydra-Nutrive (REF. 03540)
- 3 crèmes de nuit Hydra-Nutrive (REF. 03541)
- 3 Crèmes Hydratantes d'Or (REF. 03542)
- 3 crèmes nourrissantes au caviar (REF. 03543)
- 6 collagènes purs (REF. 07762)
- Sachets + Poster

Exibição de cremes contém:

- 3 Cremes de dia Hydra-Nutrive (REF. 03540)
- 3 Cremes de noite Hydra-Nutrive (REF. 03541)
- 3 Cremes hidratantes de Ouro (REF. 03542)
- 3 Cremes nutritivos de caviar (REF. 03543)
- 6 Colagénio puro (REF. 07762)
- Saquetas + Poster



## Collagène Colagénio

u.m.vta: 1  6 

30 ml

REF.07762

### Concentré de collagène à effet immédiat

Gâce à son effet raffermissant et à sa concentration, il corrige progressivement l'affaissement du visage, en particulier les zones: zone des yeux, des lèvres, le cou, etc ... Adapté à une utilisation quotidienne. Ne laisse pas de trace de gas. Absorption rapide. Appliquer quotidiennement.

### Efeito imediato

Gaças ao seu poder reafirmante e ao seu grau de concentração corrige-se gradualmente a flacidez do rosto, especialmente as zonas: contorno de olhos, lábios, pescoço, etc. Uso diário. Não é oleoso e é de rápida absorção. Aplicar diariamente.





## Contour des yeux focus 3 Contorno de olhos - focus 3

u.m.vta: 1  1200

3 ml

REF.06658

u.m.vta: 1  6 

30 ml

REF.03741



Crème de texture fraîche et légère qui aide à réparer les petites rides autour des yeux. D'usage quotidien. Grâce à ses ingrédients actifs dont l'action de la Vitamine C: Antioxydante contre radicaux libres. Camomille: Apaisante et décongestionnante. Bêta-carotènes: anti-âge.

Fournit la douceur et aide à résorber les poches, les cernes et les signes de fatigue.

Crema de textura fresca e leve que ajuda à reparação das pequenas rugas do contorno dos olhos. De uso diário. Princípios ativos: Vitamina C: antioxidante e anti-radical livre. Camomila: Calmante e descongestionante.



Betacarotenos: Anti envelhecimento. Proporciona elasticidade, ajuda a combater os papos, olheiras e sinais de fadiga.





SCAN  
ME!

### Mousse nettoyante T-PURITY Limpeza mousse T-PURITY

u.m.vta: 1  12 

200 ml

REF.06084





Excellentes propriétés sébo-régulatrices, hydratantes et revitalisantes de la peau qui éliminent délicatement le maquillage, les impuretés et l'excès d'huile sans irriter la peau. Sa texture liquide se transforme en une mousse légère et douce qui procure un nettoyage en profondeur, hydrate et maintient l'équilibre cutané. Récupère un aspect mat et velouté. Pour ses atouts, il apporte des bienfaits: Pore raffiné et réduit, brillance diffuse, texture de la peau adoucie et épurée, aspect doux et mat.

Excelentes propriedades reguladoras, hidratantes e condicionadoras da pele, que eliminam delicadamente a maquiagem, as impurezas e o excesso de óleo sem irritar a pele. Sua textura líquida é transformada em uma espuma leve que proporciona uma limpeza profunda, hidratando e mantendo o equilíbrio da pele. Recupera uma aparência mate e aveludada. Por seus ativos, proporciona benefícios: Porosidade reduzida, brilho difuso, textura da pele amaciada e purificada, aparência macia e mate

### Ligne astringente Linha adstringente

### Astringent tonique T-PURITY Tônica astringente T-PURITY

u.m.vta: 1  12 

200 ml

REF.06085



Le toner facial astringent, spécialement formulé pour les peaux grasses, régule l'excès de sébum, prévient la brillance et aide à éliminer les imperfections. Grâce à ses atouts, il ferme les pores. Il aide à obtenir un effet mat et doux sur la peau, en contrôlant la brillance et la gaisse sur la peau. Combattre et prévenir les imperfections: réguler les propriétés du sébum, aider à contrôler la prolifération bactérienne, prévenir l'infection des pores qui provoque l'apparition de l'acné.

O toner facial adstringente, especialmente formulado para pele oleosa, regula o excesso de óleo, previne o brilho e ajuda a eliminar as imperfeições. Graças aos seus ativos, fecha os poros. Ajuda a obter um efeito mate e macio na pele, controlando o brilho e a gordura da pele. Combate e previne as imperfeições: regulando as propriedades do sebo, ajuda a controlar a proliferação bacteriana, prevenindo a infecção dos poros que causam o aparecimento da acne.

### Crème astringente T-PURITY Crème astringente T-PURITY



u.m.vta: 1  1200

3 ml

REF.06657

Texture Crème-Gel fraîche et légère, formulée avec des agents matifiants hydratants et sébo-régulateurs provoqués par l'excès d'huile sur la peau. Minimise les pores, les points noirs et les boutons. Il est formulé avec des actifs végétaux agissant comme anti-inflammatoires, restructurant la barrière lipidique, les agents matifiants et les séborégulateurs.

Crème-Gel de texture fresca e leve, formulado com agentes matificantes hidratantes e reguladores de sebo, causados pelo excesso de oleosidade da pele. Minimiza poros. Acne formulado com ativos vegetais que atuam como anti-inflamatórios, reestruturação da barreira lipídica, agentes matificantes e seborreguladores.

u.m.vta: 1  12 

50 ml

REF.06086



3 ml

50 ml

### Présentoir essences 30 ml Expositor essências 30 ml

u.m.vta: 1	 1
------------	---

REF.04995

- 42 huiles essentielles
- 6 modèles de 15 ml pour chaque référence (x6)
- 1 modèle de 30 ml pour chaque référence (x6)
- Cadeau 20 brochures
- Présentoir en bois

- Expositor de 42 óleos essenciais
- 6 modelos de 15 ml para cada referência (x6)
- 1 modelo de 30 ml para cada referência (x6)
- Brochuras para presente 20
- Mostrador de madeira



### Présentoir essences en bois Expositor essências madeira

u.m.vta: 1	 1
------------	---

Vide  
Vazio

REF.04995/01



## Huiles essentielles Óleos essenciais

La majorité des huiles essentielles sont obtenues par distillation et pressage à froid, de cette façon nous obtenons un liquide qui représente l'essence pure de la plante et nous permet de profiter de toutes ses propriétés.

A maioria dos óleos essenciais é obtida por destilação e prensagem a frio, obtendo assim um líquido que representa a essência pura da planta e nos permite desfrutar de todas as suas propriedades.

### Huile Essentielle d'Orange Douce · Óleo Essencial de Laranja Doce

u.m.vta: 1



6



15 ml

REF.07752

Propriétés antioxydantes et antimicrobiennes. Réduit les rides, améliore la fermeté de la peau. Aide à combattre la cellulite et la rétention d'eau, réduisant la stagnation des fluides. L'huile essentielle d'orange a également d'autres utilisations comme anti-moustiques.

*Propriedades antioxidantes e antimicrobianas. Reduz as rugas, melhora a firmeza da pele. Ajuda a combater a celulite e a retenção de líquidos, reduzindo a estagnação de líquidos. O óleo essencial de laranja também tem outros usos como repelente de mosquito*

30 ml

REF.07753

### Huile Essentielle de Citron · Óleo essencial de limão

u.m.vta: 1



6



15 ml

REF.07754

Hydrate, nourrit et répare les peaux abîmées. Anti-rides et antioxydant illumine la peau terne. Favorise la circulation sanguine, Antiseptique et Astringent.

*Hidrata, nutre e repara a pele danificada. Antirrugas e antioxidante Clareia a pele baça. Promove a circulação sanguínea, Antisséptico e Adstringente.*



30 ml

REF.07755

NEW





**Huile Essentielle de Bergamote · Óleo Essencial de Bergamota**u.m.vta: 1  6 



15 ml

**REF.07756**

Propriétés anti-inflammatoires, antibactériennes et antiseptiques (empêche le développement des micro-organismes), anti-acné, cicatrisantes.

*Propriedades anti-inflamatórias, antibacterianas e anti-sépticas (previne o desenvolvimento de microorganismos), anti-acne, cicatrizante.*

30 ml

**REF.07757****Huile Essentielle de Saug · Óleo Essencial de Sálvia**u.m.vta: 1  6 

15 ml



**REF.07758**

Pour tous les types de peaux, il régule le sébum cutané et le tonifie. Propriétés antiseptiques, empêchant la croissance des micro-organismes. Cela aide avec différents types de problèmes de peau, tels que l'eczéma ou les poux  
Prévient le dessèchement du cuir chevelu et aide à prévenir la chute des cheveux.

*Para todos os tipos de pele, regula a oleosidade da pele e tonifica-a. Propriedades anti-sépticas, impedindo o crescimento de microorganismos. Isso ajuda com diferentes tipos de problemas de pele, como eczema ou piolhos*

*Previne o ressecamento do couro cabeludo e ajuda a prevenir a queda de cabelo.*

30 ml

**REF.07759****Huile Essentielle d'Ylang-Ylang · Óleo Essencial de Ylang Ylang**u.m.vta: 1  6 

15 ml

**REF.07760**

Antiseptique, antimicrobien et anti-inflammatoire, il améliore l'apparence de la peau en la régénérant après avoir subi des altérations telles que l'eczéma, la dermatite ou l'acné. Améliorer la circulation sanguine, stimuler le rajeunissement cellulaire. Il aide à la circulation et détoxifie la peau, rendant la cellulite beaucoup moins visible.

*Antisséptico, antimicrobiano e anti-inflamatório, melhora a aparência da pele, regenerando-a após sofrer alterações como eczema, dermatite ou acne. Melhorar a circulação sanguínea, estimulando o rejuvenescimento celular. Ajuda a circulação e desintoxica a pele, tornando a celulite muito menos visível.*

30 ml

**REF.07761****NEW**

u.m.vta: 1



6



15 ml

REF.06044

**Huile essentielle lavande · Óleo essencial lavanda**

C'est un antibiotique naturel et un agent antiseptique et cicatrisant. Drainant, Cellulite, aide à diluer les nodules sous-cutanés, est un grand antiseptique, agit efficacement contre les micro-organismes bactériens et fongiques. Anti-inflammatoire, combat les problèmes de peau tels que l'acné. Il aide également à régénérer le derme après des brûlures, car il active le métabolisme cellulaire. La lavande contribue à la régénération active du tissu pour garder la peau plus jeune. Fournit une hydratation supplémentaire. Vous pouvez également appliquer quelques gouttes de cette huile dans tout traitement du visage ou du corps.

30 ml

REF.06049

É um antibiótico natural e um agente anti-séptico e curativo. Drenagem, celulite, ajuda a diluir os nódulos subcutâneos, é um ótimo anti-séptico, age eficazmente contra microorganismos bacterianos e fúngicos. Anti-inflamatório, combate problemas de pele como acne. Também ajuda a regenerar a derme após queimaduras, pois ativa o metabolismo celular. Lavanda contribui para a regeneração ativa do tecido para manter a pele mais jovem. Fornece uma hidratação extra. Também pode aplicar algumas gotas deste óleo em qualquer tratamento facial ou corporal.



15 ml

REF.06052

**Huile essentielle rose musquée · Óleo essencial rosa mosqueta**

C'est un excellent régénérateur de peau. Il agit superficiellement comme un facteur hydratant naturel, améliorant l'hydratation. Nourrit et régénère visiblement les cicatrices et les rides atténuantes. Corrige et prévient les problèmes de peau dus au photo-vieillessement, grâce à l'auto-génération de mélanine. Pour éviter les vergetures pendant la grossesse, il est recommandé d'utiliser pendant le dernier trimestre de la grossesse dans l'abdomen et les seins. Il contribue à redistribuer la pigmentation permettant d'atténuer ou d'éliminer les taches dues à des cas d'acné, de taches solaires, etc. Action tonifiante, cicatrisante, rajeunissante et prévient l'oxydation des cellules.

30 ml

REF.06053

É um ótimo regenerador de pele. Atua superficialmente como um fator natural de hidratação, melhorando a hidratação. Nutre e regenera visivelmente atenuando cicatrizes e rugas. Corrige e previne problemas de pele devido ao fotoenvelhecimento, através da autogeração da melanina. Para evitar estrias durante a gravidez, recomenda-se usar durante o último trimestre da gravidez no abdômen e seios. Contribui para redistribuir a pigmentação permitindo que as manchas sejam atenuadas ou eliminadas, devido a casos de acne, manchas solares, etc. Ação tonificante, cura, rejuvenescimento e impede a oxidação das células.



15 ml

REF.06043

**Huile essentielle eucalyptus · Óleo essencial eucalipto**



Effet amincissant, rétention d'eau, astringent, agit comme antibactérien dans les affections cutanées, pédiculose et pellicules, effet rafraichissant, rétrécit les vaisseaux sanguins périphériques. (Idéal jambes fatiguées pour masser). L'ajout de quelques gouttes de cette huile dans le shampooing quotidien, est une excellente option pour la stimulation des follicules pileux et du cuir chevelu ainsi que pour lutter contre les pellicules. Vous pouvez également appliquer quelques gouttes de cette huile dans tout traitement du visage ou du corps.

30 ml

REF.06048

Efeito de emagrecimento, retenção de líquidos, adstringente, atua como antibacteriano em condições de pele, pediculose e caspa, efeito refrescante, encolhe vasos sanguíneos periféricos. (Pernas cansadas ideal para massagear). Adicionando algumas gotas deste óleo no xampu diário, é uma ótima opção para a estimulação dos folículos pilosos e do couro cabeludo, bem como para combater a caspa. Você também pode aplicar algumas gotas deste óleo em qualquer tratamento facial ou corporal.



u.m.vta: 1  6 

15 ml

REF.06041

**Huile essentielle arbre à thé · Óleo essencial árvore do chá**

Ses applications reposent essentiellement sur ses propriétés antibactériennes et antiseptiques, auxquelles il associe un léger effet anesthésique local. Ses propriétés: Cicatrizante, dermoprotecteur, agit directement sur la dégradation de la sueur, dermopurifiante, eczémas, plaies, taches du visage, mains, décolleté. Drainant et amincissant. Il est également utilisé pour les cuticules après qu'ils ont été retirés pour leur action antiseptique.

*Suas aplicações baseiam-se basicamente em suas propriedades antibacterianas e anti-sépticas, às quais se associa um efeito anestésico local moderado.*

*Suas propriedades: Cicatrizante, dermoprotetor, atua diretamente na degradação do suor, dermopurificante, eczema, feridas, manchas do rosto, mãos, decote. Drenagem e emagrecimento. Também é usado para cutículas depois de terem sido removidas por sua ação anti-séptica.*



15 ml

REF.06042

**Huile essentielle romarin · Óleo essencial alecrim**

**Cheveux:** Il est recommandé de renforcer les cheveux. Stimule la circulation favorisant la croissance et le renforcement des racines, et améliore la structure capillaire des cheveux fins et cassants.

**Peau:** Le romarin est largement utilisé dans les crèmes cosmétiques anti-âge, un excellent antioxydant. Certains de ses composants, tels que l'acide rosmarinique, favorisent la formation de nouvelles cellules. Il est décongestionnant, anti-inflammatoire, cicatrisant, rafraîchissant et astringent.

*Cabelo: Recomenda-se para fortalecer o cabelo. Estimula a circulação promovendo o crescimento e fortalecendo as raízes e melhorando a estrutura capilar dos cabelos finos e quebradiços.*

*Pele: O alecrim é amplamente utilizado em cremes cosméticos antienvelhecimento, um excelente antioxidante. Alguns de seus componentes, como o ácido rosmarínico, promovem a formação de novas células. É descongestionante, antiinflamatório, curativo, refrescante e adstringente.*



15 ml

REF.06045

**Huile essentielle menthe · Óleo essencial hortelã**

Dans la peau, il est très utile car il aide à retenir l'humidité en évitant le vieillissement prématuré. Si utilisé dans des massages, dans des domaines spécifiques, vous pouvez obtenir un effet relaxant unique. Appliquer dans une crème de base quotidienne, agit sur la rougeur de la peau due à l'inflammation ou l'acné. L'utilisation de l'huile essentielle de menthe a des propriétés: Régulation de la gaisse de la peau, nettoyage de l'acné, élimination de l'œdème et de la rétention d'eau, réduction de la cellulite, décongestion et action rafraîchissante de la peau.

*Na pele é muito útil porque ajuda a reter a umidade evitando o envelhecimento prematuro. Se usado em massagens, em áreas específicas, pode obter um efeito relaxante único. O óleo essencial de hortelã tem propriedades: Regulação da gordura da pele, limpeza da acne, eliminação do edema e retenção de líquidos, redução da celulite, descongestionamento e ação refrescante da pele.*

30 ml

REF.06050





**Masque facial · Máscara facial****Normal et mixte**  
**Pele normal e mista**u.m.vta: 1  12

400 ml

REF.04454

**Zone T: Avant, menton**

C'est une combinaison de peau sèche et de peau gasse. Certaines zones ont tendance à avoir plus de sébum excessif comme la zone T (front, nez et menton) et d'autres zones souffrent davantage de déshydratation, comme cela se produit habituellement dans la zone U (zone sous les pommettes et la mâchoire).

Ses actifs d'origine végétale, Rheum Rhaponticum Root Extract, agissent en activant les mécanismes naturels d'hydratation de la peau, réalisant: Reconstruction de la couche cornée et de ses composants, régulation de la desquamation, restauration de la fonction barrière

**Zona T: Frente, queixo**

É uma combinação de pele seca e pele oleosa. Algumas áreas tendem a ter mais excesso de sebo, como a zona T (testa, nariz e queixo) e outras áreas sofrem mais de desidratação, como geralmente acontece na zona U (área sob as maçãs do rosto e mandíbula).

Seus ingredientes ativos de origem vegetal, Extrato de Raiz Rumonticum Rheum, atuam ativando os mecanismos naturais de hidratação da pele, conseguindo: Reconstrução do estrato córneo e seus componentes, regulação da descamação, restauração da função barreira.

**Facial dry**  
**Peles seca**u.m.vta: 1  12

400 ml

REF.04974

**Gande hydratation**

La peau sèche a toujours besoin d'un apport important d'hydratation et de soins plus spéciaux, car ils ont tendance à rougir facilement et sont plus sensibles. Par conséquent, le masque facial pour peaux sensibles, grâce à ses principes actifs d'origine végétale, l'extrait d'écorce de salix alba (saule), l'alternifolia melaleuca, l'extrait de racine de curculigo orchioïdes, agit sur le mécanisme interne de contrôle du pH cutané, réparant la fonction barrière et provoquant une diminution de la réactivité et de la sensibilité de la peau. Ainsi, il améliore la cohésion entre les cellules, rendant ainsi l'intégrité de l'épiderme.

**Ótima hidratação**

A pele seca sempre precisa de um suprimento importante de hidratação e de cuidados mais especiais, pois tendem a ficar avermelhados com facilidade e são mais sensíveis. Portanto, a máscara facial para a pele sensível, graças aos seus ingredientes ativos de origem vegetal, extrato de casca de salix alba (salgueiro), alternifolia melaleuca, extrato de raiz de curculigo orchioïdes, atua no mecanismo interno de controle cutâneo do pH, reparando a função barreira e causando uma diminuição na reatividade e sensibilidade da pele. Assim, melhora a coesão entre as células, retornando assim a integridade da epiderme.

**Peau gasse**  
**Pele oleosa**u.m.vta: 1  12

400 ml

REF.03810

**Équilibre l'excès de gaisse**

Il maintient un équilibre hydrique hydratant et empêche tout agent extérieur tel que la sueur, l'humidité, etc., de produire des bactéries. L'un de ses composants est chargé d'exercer une action absorbante contre l'humidité. Cela permet de laisser sur la peau, un film protecteur qui cède la peau, exerçant sa fonction de catharsis et d'hydratation. Son extrait actif de feuille de barosma betulina, équilibre les excès de gaisse et traite les pores visibles en diminuant leur nombre et leur taille, équilibrant la sécrétion sébacée et améliorant visiblement la texture de la peau.

**Equilibra o excesso de gordura**

Mantém um equilíbrio hidratante da água e impede que qualquer agente externo, como suor, umidade, etc., produza bactérias. Um de seus componentes é responsável por exercer uma ação absorvente contra a umidade. Isso permite deixar sobre a pele, um filme protetor que cede à pele, exercendo sua função de catarse e hidratação. Seu extrato ativo de folhas de barosma betulina, equilibra o excesso de gordura e trata os poros visíveis, diminuindo-os em número e tamanho, equilibrando a secreção sebácea e melhorando visivelmente a textura da pele.

## Sauna facial

### Sauna facial

u.m.vta: 1  4

105 W

REF. 03280

- Indiqué pour nettoyer la peau et soulager les maladies respiratoires
- Accessoires: tasse à mesurer et accessoire pour le nez
- Diffuseur pour que le spray soit constant
- Chauffage PTC de haute qualité
- Facile à nettoyer
- Puissance: 105 W

- Indicado para limpeza da pele e para o alívio de problemas respiratórios
- Acessórios: copo de medição e acessório para o nariz
- Difusor para que o spray seja constante
- Aquecedor PTC de alta qualidade
- Fácil de limpar
- Potência: 105 W

MEDISANA®



## Vapor facial

### Vapor facial

u.m.vta: 1  1

1 L

REF.04952

SCAN  
ME!

Utilisez uniquement avec de l'eau distillée. Avec fonction vapeur froide et chaude. La vapeur incorpore la fonction de vapeur OZONE, qui génère plus de vapeur d'eau dans les vapeurs froide et chaude. Lorsque l'eau est en dessous du minimum, la vapeur s'éteindra automatiquement pour des raisons de sécurité. La tête peut pivoter à 120°.

- Tension: 220-240V
- Fréquence: 50-60Hz
- Puissance: 650 W
- Capacité de dépôt: 1L

Use apenas com água destilada. Com função de vapor frio e quente. O vapor incorpora a função de vapor OZONE, que gera mais vapor de água tanto no vapor frio quanto no quente. Quando a água estiver abaixo do mínimo, o vapor será desligado automaticamente por segurança. Pode girar 120°

- Tensão: 220-240 V
- Freqüência: 50-60Hz
- Potência: 650 W
- Capacidade de depósito: 1L





### Sac 10 mini spatules pour crème transparentes Embalagem 10 mini espátulas para creme transparentes

u.m.vta: 1  100

REF.07328





### Brosse nettoyage et massage Escova facial massagem

u.m.vta: 1  20 

REF.01811

Idéal pour l'exfoliation  
Ideal para esfoliação

u.m.vta: 1  50 

REF.06660

Avec capuchon de protection des poils en nylon doux.  
Com tampa protetora das puas em nylon suave.



### Pinces (Extracteurs) Anti Points Noirs Pinça de limpeza

u.m.vta: 1  50

Dissolvant de gande taille  
Verniz gande

REF.01477

u.m.vta: 1  50

Dissolvant de petit taille  
Verniz pequeno

REF.01478

u.m.vta: 1  40



Double usage  
Dupla

REF.01479



## Éponges konjac

### Esponjas konjac

u.m.vta: 1  12 

Des éponges de texture extra fine et fabriquées à partir des racines de konjac, riches en minéraux. Il est 100% naturel, biodégradable + durable + respectueux de l'environnement. Sans colorants, conservateurs et pigments artificiels. Antimicrobien grâce à sa nature alcaline, il a une grande capacité à nettoyer la peau. Avec l'utilisation de l'éponge, il n'est pas nécessaire d'utiliser du savon ou des nettoyants, puisque l'éponge seule a la capacité d'enlever toute la saleté et les impuretés de la peau.

*Esponjas de textura extra fina e feitas a partir das raízes do konjac, rico em minerais. É 100% natural, biodegradável + sustentável + respeitoso com o meio ambiente. Sem corantes, conservantes e pigmentos artificiais. Antimicrobiano graças à sua natureza alcalina, tem grande capacidade de limpar a pele. Com o uso da esponja, não é necessário usar sabão ou produtos de limpeza, uma vez que a esponja sozinha tem a capacidade de remover toda a sujeira e impurezas da pele.*

REF.04970



#### Charbon de bambou naturel

- Il élimine l'excès de sébum, exfolie en douceur, nettoie en profondeur les pores qui peuvent causer des bactéries responsables de l'acné
- Élimine les points noirs laissant derrière un film pour nourrir et améliorer la barrière protectrice de la peau, sans avoir besoin d'utiliser des abrasifs chimiques
- Équilibre le pH de la peau. Particulièrement indiqué pour les peaux grasses et à tendance acnéique
- Ne convient pas aux peaux sensibles.
- L'éponge doit être remplacée tous les 2 mois.

#### Carvão vegetal de bambu natural.

- Remove o excesso de sebo, esfolia suavemente, limpa poros em profundidade que podem causar bactérias que causam acne
- Elimina os pontos negos deixando para trás um filme para nutrir e melhorar a barreira protetora da pele, sem a necessidade de usar abrasivos químicos
- Equilibra o pH da pele. Especialmente indicado para pele oleosa e com tendência acneica
- Não é adequado para peles sensíveis.
- A esponja deve ser substituída a cada 2 meses.

REF.04971



#### Aloe vera Apaisant, hydratant et hydratant

- Équilibre le pH de votre peau
- Laissez un film pour nourrir et améliorer le
- Barrière protectrice de la peau.
- Il aidera à apaiser et hydrater la peau
- Idéal pour les peaux normales et mixtes
- L'éponge doit être remplacée tous les 2 mois.

#### Aloe vera Calmante, hidratante e hidratante

- Equilibra o pH da sua pele
- Deixe um filme para nutrir e melhorar a barreira protetora da pele
- Ajudará a acalmar e hidratar a pele
- Ideal para pele normal e mista
- A esponja deve ser substituída a cada 2 meses.

REF.04972



#### Gaines de roses bulgares. Hydrate, nourrit et régénère

- Laissez un film qui hydrate, nourrit et améliore la barrière protectrice de la peau
- Réduit le besoin d'utiliser des savons Ils peuvent irriter votre peau délicate
- Il a un effet calmant naturel
- Particulièrement adapté pour les peaux très sensibles et même aux premiers âges
- L'éponge doit être remplacée tous les 2 mois.

#### Sementes de rosas búlgaras. Hidrata, nutre e regenera

- Deixe um filme que hidrata, nutre e melhora a barreira protetora da pele
- Reduz a necessidade de usar sabonetes que podem irritar sua pele delicada
- Tem um efeito calmante natural
- Especialmente adequado para peles sensíveis
- A esponja deve ser substituída a cada 2 meses.



02

## Ligne de soins corporels Linha de cuidados corporal

*Crèmes, traitements, accessoires...*

*Cremes, tratamento, acessórios...*





## Huiles de base · Óleos base

Les huiles de base sont également connues en tant qu'huiles de support ou huiles de véhicules. Ils agissent en tant que porteurs (véhicules) dans l'application des huiles essentielles sur le visage et le corps, en facilitant le mouvement nécessaire dans le massage en raison de la lubrification qu'ils offrent et, en même temps, fournissent les propriétés thérapeutiques propres au mélange. Ce sont des huiles fixes, c'est-à-dire qu'elles ne s'évaporent pas (contrairement aux huiles essentielles). Enrichi avec de l'huile de pépin de raisin. Propriétés, hautement émoullent, protecteur, idéal comme véhicule de pénétration pour d'autres composants lorsqu'il est combiné avec divers ingrédients actifs. En raison de sa teneur élevée en antioxydants, vitamines C, D, E et Betacarotène, il augmente la résistance de la peau, ce qui le rend plus élastique. Il est absorbé très rapidement et peut être utilisé sur n'importe quel type de peau.

Os óleos básicos são também conhecidos como óleos transportadores ou óleos veiculares. Eles atuam como veículos na aplicação de Óleos Essenciais no rosto e no corpo, facilitando o movimento necessário na massagem devido à lubrificação que oferecem e, ao mesmo tempo, proporcionam as propriedades terapêuticas próprias da mistura. São óleos fixos, não evaporam (ao contrário dos essenciais). Enriquecido com óleo de pimenta. Propriedades altamente protetoras, emolientes, ideais como veículo de penetração para outros componentes quando combinadas com vários ingredientes ativos. Devido ao seu alto teor de antioxidantes, vitaminas C, D, E e Betacarotene, aumenta a resistência da pele, tornando-a mais elástica. É absorvido muito rapidamente e pode ser usado em qualquer tipo de pele.



### Huile de base calendula Óleo base calêndula

u.m.vta: 1  4 

1 L

REF.06036

Il a des propriétés anti-inflammatoires et apaisantes, donc après avoir soumis la peau à des traitements agressifs tels que l'épilation à la cire ou l'exfoliation, l'utilisation de l'huile produit une sensation de relaxation et de soulagement des rougeurs. Grand pouvoir hydratant, nourrissant et nettoyant. Particulièrement utile pour les peaux sensibles comme les bébés ou les personnes qui souffrent d'une irritation constante. Convient aux peaux sèches ou très sèches. Riche en vitamine E. Il peut être utilisé directement comme démaquillant, en particulier dans les peaux très sensibles qui irritent facilement.

Tem propriedades anti-inflamatórias e calmantes, por isso, depois de submeter a pele a tratamentos agressivos, como a depilação com cera ou esfoliação, o uso de óleo produz uma sensação de relaxamento e alívio. Gande poder hidratante, nutritivo e purificador. Especialmente útil para peles sensíveis, como bebês ou pessoas que sofrem irritação constante. Adequado para pele seca ou muito seca. Rico em Vitamina E. Pode ser usado diretamente como removedor de maquiagem, especialmente em peles muito sensíveis que irritam facilmente.



Plus  
d'informations  
Mais  
information



SCAN  
ME!



## Huiles de base · Óleos base

### Huile de base d'amande douce

#### Óleo base amêndoa doce

u.m.vta: 1  4 

1 L

REF.06037



L'huile d'amande douce est l'une des huiles par excellence pour le massage. Propriétés: donne élasticité et douceur à la peau. Bonne pénétration dans la peau, ne laissant pas la peau grasse. Nutritif et régénérateur. Convient à tous les types de peau, y compris les enfants et les personnes âgées. Idéal pour les peaux fragiles ou craquelées. Renforceur de cheveux faibles, aide à la disparition des écailles sur le cuir chevelu. C'est un hydratant et un régénérateur de cils naturels.

*O óleo de amêndoa doce é um dos óleos por excelência para a massagem. Propriedades: dá elasticidade e maciez à pele. Boa penetração na pele, não deixa a pele oleosa. Nutritivo e regenerativo. Adequado para todos os tipos de pele, incluindo crianças e idosos. Ideal para peles frágeis ou rachadas. Fortalecedor de cabelos fracos, ajuda o desaparecimento de escamas no couro cabeludo. É um hidratante natural para os cílios regenerador*



### Huile de base rose musquée

#### Óleo base rosa mosqueta

u.m.vta: 1  4 

1 L

REF.06035

Rose musquée est un excellent régénérateur de peau. Il agit superficiellement comme un facteur hydratant naturel, améliorant l'hydratation. Nourrit et régénère visiblement réduire les cicatrices et les rides. Corrige et prévient les problèmes de peau dus au photo-voileissement, grâce à l'auto-génération de mélanine. Il contribue à redistribuer la pigmentation permettant d'atténuer ou d'éliminer les taches. Action tonifiante, cicatrisante, rajeunissante et prévient l'oxydation des cellules.

*Rosa Mosqueta é um ótimo regenerador de pele. Atua superficialmente como um fator natural de hidratação, melhorando a hidratação. Nutre e regenera visivelmente reduzindo cicatrizes e rugas. Corrige e previne problemas de pele devido ao fotoenvelhecimento, através da autogeração da melanina. Contribui para redistribuir a pigmentação, permitindo que as manchas sejam atenuadas ou eliminadas. Ação tonificante, cura, rejuvenescimento e impede a oxidação das células.*



### Huile de base jojoba

#### Óleo base jojoba

u.m.vta: 1  4 

1 L

REF.06038

Excellente pénétration dans la peau ne laissant pas la peau grasse en raison de sa bonne capacité d'absorption. Recommandé pour les peaux grasses ainsi que pour le traitement anti-acné pour ses propriétés bactéricides, en tant que traitement anti-séborrhéique, dissout le sébum qui se dépose dans les follicules pileux actifs, obstruant la croissance des cheveux. Excellente huile capillaire car elle nourrit les cheveux secs et cassants. Il agit comme un protecteur contre les irritations possibles ou les changements de peau provoqués par des colorants et des permanentes.

*Excelente penetração na pele, não deixa a pele oleosa devido à sua boa capacidade de absorção. Recomendado para pele oleosa e para tratamento anti-acne devido às suas propriedades bactericidas, como o tratamento anti-seborréico, dissolve o sebo que é depositado nos folículos capilares ativos, obstruindo o crescimento do cabelo. Excelente óleo capilar, pois nutre os cabelos secos e quebradiços. Atua como um protetor contra possíveis irritações ou alterações na pele causadas por corantes e permanentes.*



Plus  
d'informations  
Mais  
information



SCAN  
ME!



## Huiles de base · Óleos base

### Huile de base d'arbre à thé

#### Óleo base árvore do chá

u.m.vta: 1  4 

1 L

REF.06051

Fondamentalement, les applications sont fondamentalement en plus des propriétés bactéricides et antiseptiques, il a un anesthésique local avec un effet doux. Ses propriétés: Cicatrizante, dermoprotecteur, agit directement sur la dégradation de la sueur, dermopurifiante, eczéma, plaies, taches sur le visage, mains, décolleté. Drainant et amincissant. Il a également été utilisé pour les cuticules hachées ont été retirés pour leur action antiseptique.

*Suas aplicações baseiam-se basicamente em suas propriedades antibacterianas e anti-sépticas, às quais se associa um efeito anestésico local moderado. Suas propriedades: Cicatrizante, dermoprotetor, atua diretamente na degradação do suor, dermopurificante, eczema, feridas, manchas no rosto, mãos, decote. Drenagem e emagecimento.*



### Huile de base d'olive

#### Óleo base oliva

u.m.vta: 1  4 

1 L

REF.06039

Propriétés émoullientes, antioxydantes, tonifiantes, hydratantes et apaisantes. Il a un profil lipidique très similaire à celui de la peau humaine. Rétablit l'hydratation et la fonction de barrière cutanée, favorisant la régénération cellulaire. Son application sur la peau agit comme une réparation émoulliente et protège contre le vieillissement prématuré. Activité antimicrobienne et antibactérienne.

*Propriedades emolientes, antioxidantes, tonificantes, hidratantes e calmantes. Tem um perfil lipídico muito semelhante ao da pele humana. Restaura a unidade e a função barreira cutânea favorecendo a regeneração celular. Sua aplicação na pele atua como um emoliente reparador e protetor contra o envelhecimento precoce. Atividade antimicrobiana e antibacteriana.*



### Huile de base d'argan

#### Óleo base argão

u.m.vta: 1  4 

1 L

REF.06040

Il contient des antioxydants tels que la vitamine E et est riche en acides gras. Régénérant, raffermissant les tissus car il renforce les fibres de collagène et d'élastine, améliore la barrière cutanée permettant de réduire la perte d'hydratation, anti-inflammatoire à utiliser après exposition solaire, nutritive et régénératrice. Grâce à son contenu en tocophérols il a un grand pouvoir antioxydant, agissant en profondeur dans la malnutrition de la peau. Idéal pour les cheveux et les ongles car il leur donne brillance et renforce grâce à leur grande capacité nutritionnelle.

*Contém antioxidantes como a vitamina E, é rica em ácidos gaxos. Regeneração, endurecimento dos tecidos, uma vez que reforça as fibras de colágeno e elastina, melhora a barreira cutânea da pele, permitindo a redução da perda de hidratação, anti-inflamatório para uso após a exposição ao sol, nutritivo e regenerativo. Gaças ao seu conteúdo em tocoferóis, possui um grande poder anti-oxidante, atuando em profundidade na desnutrição da pele. Ideal para cabelos e unhas, pois lhes dá brilho e fortalece através de sua alta capacidade nutricional.*





## Exfoliant corps

### Exfoliante corporal

u.m.vta: 1  20

REF.06648

Huile d'argan et noyau d'abricot.

Huile d'argan et noyau d'abricot. L'utilisation de l'exfoliant corporel aide à faire glisser les cellules mortes de la peau qui s'accumulent malgré le nettoyage, empêchant une oxygénation adéquate. Adoucit la peau qui apparaît plus lisse et plus brillante, la préparant à recevoir des traitements spécifiques dont les actifs vont mieux pénétrer après l'exfoliation. Arôme fruité agréable.

Il peut être utilisé comme un gommage régulier du corps en raison des propriétés naturelles et douces du noyau d'abricot.

Ne convient pas aux peaux sensibles.

*Óleo de Argão e caroço de damasco.*

*Óleo de Argão e caroço de damasco. O uso do exfoliante corporal ajuda a remover as células mortas da pele que se acumulam apesar da limpeza impedindo a sua correta oxigenação. Suaviza a pele, tornando-a mais firme e luminosa, preparando-a para receber os tratamentos específicos cujos princípios ativos penetrarão melhor após a exfoliação. Agadável aroma frutado.*

*Pode usar-se como exfoliante corporal habitual pelas propriedades naturais e suaves do caroço de damasco.*

*Não é adequado para peles sensíveis.*



## Kit exfoliant avec éponge en caoutchouc en cadeau

### Kit exfoliante com esponja de borracha como presente

u.m.vta: 1  12

REF.04883



Ref. 06648

Ref. 06071

Ref. 04590

## Sels de la mer morte, algues, extrait de citron

### Sais do mar morto, algas, extrato de limão



Pour des traitements visant à réduire l'aspect et l'intensité de la cellulite ou de la «peau d'orange», nous avons des traitements raffermissants, tonifiants et réducteurs. Tous avec des produits naturels tels que les sels de la mer morte, les algues ou l'extrait de citron. Avec l'aide de massages circulaires dans les zones à traiter, nous aiderons pour l'absorption du produit.

Para tratamentos de ajuda na redução do aspeto e da quantidade de celulite ou "Pele casca de laranja", dispomos de tratamentos reafirmantes, tonificantes e redutores. Todos com produtos naturais tais como sais do Mar Morto, algas ou extrato de limão. Ao fazer massagens circulares nas zonas mais problemáticas ajudaremos a pele na absorção do produto.

## Anticellulite effet de chaleur

### Anti-celulíticos efeito calor

u.m.vta: 1  25

REF.03546

#### Sels de la Mer Morte, Aloe vera et Huile d'Argan

Pour ses actifs Sels de la Mer Morte. La combinaison adéquate d'algues aussi puissantes que LAMINARIA et FUCUS, avec Ruscus, Iodine Extensine, la caféine entre autres, permet de dégager et de mobiliser l'accumulation graisseuse (lipolyse). L'activation de la circulation et l'élévation localisée de la température créent les conditions nécessaires au développement de ces processus, convertissant cette crème en un produit idéal pour le traitement de la Cellulite et du Volume. L'huile d'argan et l'Aloe Vera ont des propriétés restructurantes et régénérantes.

EFFET DE CHALEUR. Masser et surtout l'utiliser dans les zones à traiter (fesses, hanches, cuisses, etc.). Elle Combat également la soi-disant "peau d'orange". Elle Active la microcirculation. Non recommandée pour les peaux sensibles.

#### Sais do Mar Morto, Aloé Vera e Óleo de Argão

Seus ativos Sais do Mar Morto. A combinação adequada de algas tão poderosas como LAMINARIA e FUCUS, com Ruscus, Iodine Extensine, Cafeína entre outras, permite degadar e mobilizar o acúmulo de gordura (lipólise). A ativação da circulação e a elevação localizada da temperatura criam as condições necessárias para o desenvolvimento desses processos, convertendo este creme em um produto ideal para o tratamento da celulite. O óleo de argão e Aloe Vera, tem propriedades de reestruturação e regeneração.

EFEITO CALOR. Massajar especialmente nas zonas mais problemáticas (nádegas, coxas, pernas, etc.). Combate também a chamada "Pele casca de laranja". Ativa a microcirculação. Não recomendada para peles sensíveis.

250 ml



## Raffermissante et remodelante

### Reafirmante modelador

u.m.vta: 1  20

250 ml

REF.03932

#### Extrait de citron, de collagène et d'algues.

Raffermit la peau en stimulant l'activité cellulaire, améliore l'élasticité et la fermeté. Aide à éliminer les toxines et remodelé la silhouette. Masser pour la faire pénétrer dans la zone à traiter.

#### Extrato de limão, Colagénio e Algas

Extrato de limão, Colagénio e Algas. Reafirma a pele estimulando a atividade celular, melhora a elasticidade e a firmeza. Ajuda a eliminar toxina e modela a silhueta. Massajar e incidir nas zonas problemáticas.

250 ml



500 ml



u.m.vta: 1  5

500 ml

REF.03931

## Huile d'argan + aloe vera Óleo de argão + aloé vera



L'huile d'argan pénètre rapidement dans la peau en la laissant hydratée et sans excès de graisse. L'Arganier (*Argania Spinosa*), qui pousse uniquement dans le sud-ouest du Maroc, est par nature un arbre unique au monde. L'huile est extraite sans aucune utilisation de produits chimiques, c'est un produit biologique aux bénéfices avérés. Les analyses chimiques réalisées confirment ses précieuses propriétés dermatologiques et la combinaison avec l'Aloe Vera renforce les effets cicatrisants et régénérateurs.

*O Óleo de Argão penetra rapidamente na pele deixando-a hidratada e não oleosa. A árvore de Argania Spinosa, que cresce apenas no sudoeste de Marrocos, é pelas suas características, uma árvore única no mundo. O Óleo é extraído sem a utilização de produtos químicos, é um produto biológico com benefícios demonstrados. As análises químicas realizadas confirmam as suas valiosas propriedades dermatológicas e a combinação com o Aloé Vera faz com que se potenciem os efeitos cicatrizantes e regenerativos.*

### Lotion hydratante corporelle Loção hidratante leite corporal

u.m.vta: 1



8

REF.04458

#### Huile d'argan et aloe vera

Gâce à l'Huile d'Argan et à l'Aloe Vera qui apportent douceur, hydratation et grand effet régénérant à la peau, la renforcent et la préparent au stress quotidien, de sorte que son utilisation continue aide à réguler et prévenir l'apparition de flaccidité et de signes de vieillissement. D'une absorption rapide. Particulièrement indiquée pour les peaux sèches.

#### Óleo de argão e aloé vera

Grças ao Óleo de Argão e ao Aloé Vera que proporcionam suavidade, hidratação e um grande poder de regeneração à pele fortalecendo-a e preparando-a para o stress diário, de tal forma que o seu uso contínuo ajuda a regular e a evitar a flacidez e sinais de envelhecimento. De rápida absorção. Especialmente indicada para peles secas.



**Medisana vibration du bâton de massage et lumière rouge**  
**Medisana massagem vibração com luz vermelha**

u.m.vta: 1  4

**REF.06590**





- Massage agréable par vibration
- Possibilité de régler différents angles de massage
- Comprend 5 accessoires de massage interchangeables
- La lumière rouge et la chaleur peuvent également être connectées
- 2 niveaux d'intensité de massage réglable
- Conception pratique pour un auto-massage confortable

- *Massagem agradável por vibração*
- *Possibilidade de ajustar diferentes ângulos de massagem*
- *Inclui 5 acessórios de massagem intercambiáveis*
- *Luz vermelha e calor adicionalmente conectável*
- *2 níveis de intensidade de massagem ajustável*
- *Design prático para auto-massagem confortável*



## Liquide de traitement de bandage froid

### Líquido de tratamento com bandagem fria

u.m.vta: 1  6 

REF.07012

RELAXANT - RAFRAÎCHISSANT - DESCONGESTIONANTE - ANTICELULITICO  
Mélange: 1 partie de bandages froids liquides + 3 parties d'eau

Lotion cosmétique aux principes actifs Végétaux (Fucus, Ivy, Aquifolium) et hypothermiques qui produisent un refroidissement local de la température dans la zone traitée pendant un temps contrôlé.

#### MODE D'EMPLOI:

Mélanger une partie de la lotion avec 3 parties d'eau et faire tremper les bandages dans le mélange, en enveloppant avec eux la zone à traiter. Gardez 30 à 45 minutes et ne prenez pas de douche dans environ 2 heures. Utiliser deux ou trois fois par semaine

RELAXANTE - REFRESCANTE - DESCONGESTIONANTE - ANTICELULITICO

Ação redutora Ingredientes ativos vegetais e hipotérmicos

CONCENTRADO 1 x 3

Mistura: 1 parte de ataduras frias líquidas + 3 partes de água

Loção cosmética com ingredientes ativos Vegetal (Fucus, Ivy, Aquifolium) e hipotérmica que produz um resfriamento local da temperatura na área tratada durante um tempo controlado.

#### MODO DE EMPREGO:

- Misture uma parte da Loção com 3 partes de água e deixe de molho os curativos na mistura, envolvendo com eles a área a ser tratada. Mantenha 30 a 45 minutos e não tome banho em cerca de 2 horas. Use duas ou três vezes por semana



## Rouleau de bandages froids 15x10 crêpes

### Rolo bandas frias 15x10 crepe

u.m.vta: 1  50

REF.07108



Fabriqué en crêpe épais et élastique pour les traitements de bandage à froid et les traitements de compression. Faire tremper les bandages dans le liquide de bandage froid (07012) pour faire un traitement anticellulite, anti-inflammatoire, etc.

Feito de tecido crepe espesso e elástico para tratamentos de bandagens frias e tratamentos de compressão. Mergulhe as bandagens no líquido de bandagem fria (07012) para fazer um tratamento anticelulite, anti-inflamatório, etc.

## Rouleau de bandages froids 10x10 crêpes

### Rolo bandas frias 10x10 crepe

u.m.vta: 1  65

REF.03041



Bandage élastique à la fois longitudinal et transversal. Composition: coton: 93,84%, élastomère enrobé: 6,2% Qualité supérieure Bandage de tricot de chaîne sur les côtés. Idéal pour les traitements corporels.

Atadura elástica longitudinal e transversal. Composição: Algodão: 93,84%, elastômero revestido: 6,2% Qualidade superior Bandagem de tecido de malha de urdidura em seus lados. Ideal para tratamentos corporais.

**Brosse de bain de couleurs**  
Luva/esponja diferentes cores

u.m.vta: 12  96

    
**REF.01916**



**Gant de CRIN**  
Luva/esponja CRIN

u.m.vta: 1  20 

**REF. 01084**



**Gande éponge de bain / massage en caoutchouc , de couleurs**  
Espanja banho/massagem de borracha, gande diferentes cores

u.m.vta: 1  16 

**REF. 04591**

- Double type de dents.
- Idéal pour la circulation, la cellulite, les peaux sensibles.
- Longue durée, n'accumule pas les cheveux et nécessite peu de savon.
- Tipo duplo de dentes.
- Ideal para circulação, celulite, pele sensível.
- De longa duração, não acumula pelos e precisa de pouco sabonete.

u.m.vta: 1  24 

**REF. 04590**

   Gande · Gande



   Petite · Pequena





**Brosse de toilette**  
Escova de banheiro

u.m.vta: 1  12 

**REF. 00526**

- Poil de cheveux. Manche en bois
- Cerdas naturais. Botão de madeira

u.m.vta: 1  15 

**REF. 00679**

- Poils nylon
- Cerdas nylon

Bois · Madeira



Couleurs · Cores



03



## Épilation Depilação

*Cire kg, roll-on de cire, chauffe cire,  
accessoires, pince à épiler...*

*Cera kg, cera roll-on, cera melters,  
accessórios, pinças depilam...*



## Sachet de 1 Kg de perles de Cire Bolsa de 1 Kg de Cera em pérolas

u.m.vta: 1  6 

Perles Cire Miel  
Pérolas Cera Mel

**REF.07465**

Perles Cire rose - Peux sensibles  
Pérolas Cera rosa - Peles Sensíveis

**REF.07466**

Perles Cire verte - Aloe Vera  
Pérolas Cera verde - Aloé Vera

**REF.07467**

Perles Cire Azulène  
Pérolas Cera Azuleno

**REF.07468**



Faire fondre la cire dans un chauffe-cire. Bien mélanger jusqu'à obtenir une cire douce et homogène.

Avant application, vérifier que la température de la cire soit optimale. Appliquer à l'aide d'une spatule en bois ou métallique une couche de cire dans le sens de la croissance du poil. Ne pas laisser complètement refroidir et retirer en tirant d'un coup sec à rebrousse poils pour extraire la racine.

- Efficace sur poils courts.
- Aux ingrédients naturels
- Épilation parfaite et durable
- Ne pas utiliser de bandes

Derreter a cera num fundidor. Misturar bem até se conseguir uma cera suave e homogênea.

Antes de aplicar, comprovar se a temperatura da cera é a ideal. Aplicar com uma espátula de madeira ou metálica uma camada de cera na mesma direção do crescimento dos pelos. Não deixar arrefecer completamente e retirar no sentido contrário aos pelos com um puxão para se conseguir extraí-los desde a raiz.

- Eficaz nos pelos curtos
- Com ingredientes naturais
- Depilação perfeita e duradoura
- Não usar tiras



## Sachet 1 Kg de Disques en cire

### 1 Kg discos cera

u.m.vta: 1



6

**REF.04675**

- Disques de cire **brésilienne**
- Bidirectionnel
- Extra-flexible
- N'a pas besoin de bandes de papier

- Discos de cera **brasileiros**
- Bidirecional
- Extra flexível
- Não precisa de bandas de papel



1 kg

**REF. 03916**Miel  
Mel**REF. 03917**

Pour peaux sensibles au dioxyde de titane  
*Peles sensíveis com dióxido de titânio*

**REF. 03918**Aloe Vera  
Aloe Vera**REF. 03919**

Huile d'argan  
*Óleo de Argão*

**REF. 03920**Cacao  
Cocoa**REF. 04260**"Azuleno"  
"Azuleno"

L'épilation avec des cires à bas point de fusion est très efficace pour l'épilation. Sa formulation spéciale à base de cire d'abeille naturelle et de colophane de haute qualité prépare la peau en adoucissant les pores. Son adhésion est totale, donc il extrait les cheveux de la racine, retardant ainsi son apparition. Pour obtenir une consistance élastique et crémeuse à température ambiante, certaines de nos cires sont à base de dioxyde de titane. De cette manière, nous atteignons un point de fusion plus bas qui favorise l'épilation. Prix échelonnés combinables à partir de la boîte de 6 unités avec toutes les références en page 612 sauf la référence 04675.



Depilação com ceras de baixo ponto de fusão é muito eficaz na remoção de pêlos. Sua formulação especial baseada em cera natural de abelha e resina de alta qualidade prepara a pele suavizando o poro. Sua adesão é total para extrair o cabelo da raiz, retardando sua aparência. Para obter uma consistência cremosa e elástica à temperatura ambiente, algumas de nossas ceras são feitas com dióxido de titânio. Desta forma, conseguimos um ponto de fusão mais baixo que favorece a depilação. Preços em escala combináveis a partir da caixa de 6 unidades com todas as referências na página 612 exceto a referência 04675.

**Sachet 1 kg de cire fabriqué en Espagne****1 kg de cera feita na Espanha**

Zone de traitement: aisselles, bras, lèvre supérieure, facial, corps. Choisissez celui qui s'adapte le mieux en fonction de son élasticité, au type de poil et de peau: transparent, élastique, en couleur, parfumé, faible fusion, etc. Prix échelonné combinable avec l'une des références à la page 613-614.

Área de tratamento: axilas, braços, lábio superior, facial, corporal. Escolha o que melhor se adapte de acordo com a sua elasticidade, ao tipo de pelo e pele: transparente, elástico, com cor, perfumado, baixo derretimento, etc. Preço em escala combinável com qualquer uma das referências na página 613-614.

**Disques en cire rose - élasticité double supérieure****Discos cera rosa- elasticidade superior dupla**

u.m.vta: 1  12 



1 kg

**REF.06323**

Flexibles, ils permettent d'appliquer une fine couche réduisant la sensation de chaleur. La cire classique, spéciale pour le rasage anglais et les aisselles.

*Flexíveis, permitem aplicar uma capa fina reduzindo a sensação de calor. A cera clássica, especial para barbear e axilas.*

**Disques en cire verte - élasticité supérieure****Discos cera verde - maior elasticidade**



u.m.vta: 1  12 

**REF.06324**

Transparent ou semi-transparent, avec une texture fluide, un départ fort et un séchage rapide. Léger et cristallin, adapté à toutes les zones du corps.

*Transparente ou semitransparente, com uma textura fluida, forte arranque e secagem rápida. Leve e cristalino adequado para qualquer área do corpo.*

**Disques en cire de bleus - élasticité supérieure****Discos cera azul - maior elasticidade**

u.m.vta: 1  12 

**REF.06325**

Transparent ou semi-transparent, avec une texture fluide, un départ fort et un séchage rapide. Léger et cristallin, adapté à toutes les zones du corps.

*Transparente ou semitransparente, com uma textura fluida, forte arranque e secagem rápida. Leve e cristalino adequado para qualquer área do corpo.*



**Sachet 1 kg de cire fabriqué en Espagne**  
**1 kg de cera feita na Espanha**



Zone de traitement: anglais, aisselles, bras, lèvre supérieure, facial, corps. Choisissez celui qui s'adapte le mieux en fonction de son élasticité, au type de poil et de peau: transparent, élastique, en couleur, parfumé, faible fusion, etc.  
 Prix échelonné combinable avec l'une des références à la page 613-614.

Área de tratamento: axilas, braços, lábio superior, facial, corporal. Escolha o que melhor se adapte de acordo com a sua elasticidade, ao tipo de pelo e pele: transparente, elástico, com cor, perfumado, baixo derretimento etc.  
 Preço em escala combinável com qualquer uma das referências na página 613-614.

**Disques en cire chocolat - élasticité triple supérieure**  
**Discos cera chocolate - elasticidade tripla superior**

u.m.vta: 1 12

1 kg

**REF.06328**

Flexibles et élastiques, ils favorisent l'application et l'élimination des peaux douces et légèrement agressives. Épilation douce, laisse la peau légèrement parfumée.

*Flexíveis e elásticos, favorecem a aplicação e remoção de pele macia e levemente agressiva. Suave depilação, deixa a pele levemente perfumada.*



**Disques en cire vin - élasticité triple supérieure**  
**Discos cera cor vinho - elasticidade tripla superior**

u.m.vta: 1 12

1 kg



**REF.06327**

Flexibles et élastiques, ils favorisent l'application et l'élimination des peaux douces et légèrement agressives. De couleur intense, il procure une épilation douce laissant la peau légèrement parfumée.

*Flexíveis e elásticos, favorecem a aplicação e remoção. De cor intensa, proporciona uma depilação suave deixando a pele levemente perfumada*



## Boîte disques cire d'Aloe Vera Caixa 20 discos cera Aloe Vera

u.m.vta: 1  24 

**REF. 04070**

d'Aloe Vera  
Aloe Vera



**REF. 04071**

Miel  
Mel



**REF. 04072**



Peau sensible  
Pele sensível



L'épilation avec des cires à bas point de fusion est très efficace pour l'épilation. Sa formulation spéciale à base de cire d'abeille naturelle et de colophane de haute qualité prépare la peau en adoucissant les pores. Son adhésion est totale, donc il extrait les poils de la racine, retardant ainsi leur apparition. Pour obtenir une consistance élastique et crémeuse à température ambiante, certaines de nos cires sont à base de dioxyde de titane. De cette manière, nous atteignons un point de fusion plus faible qui favorise l'épilation. Prix évolutif combinable avec la page 615.

Depilação com ceras de baixo ponto de fusão é muito eficaz na remoção de pêlos. Sua formulação especial baseada em cera natural de abelha e resina de alta qualidade prepara a pele suavizando o poro. Sua adesão é total para extrair o pelo da raiz, retardando sua aparência. Para obter uma consistência cremosa e elástica à temperatura ambiente, algumas de as nossas ceras são feitas com dióxido de titânio. Desta forma, conseguimos um ponto de fusão mais baixo que favorece a depilação. Preço escalável combinável com a página 615.

### Boîte de cire miel Bandeja Cera Mel

u.m.vta: 1  12 

Miel  
Mel

500 g

REF. 03722

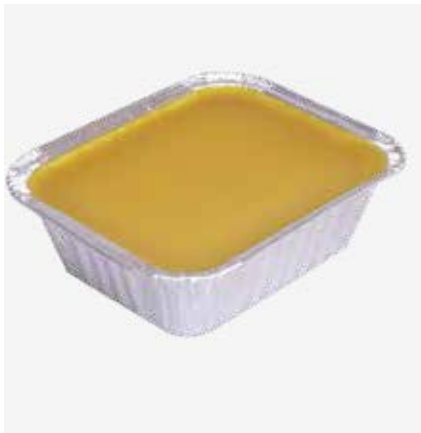

Chlorophylle  
Clorofila

500 g

REF. 03726



### Bidon de cire Lata cera

u.m.vta: 1  24

Peau sensible  
Pele sensível

REF.04563



Miel  
Mel

REF.03728



d'Aloe Vera  
Aloe Vera

REF.04735



u.m.vta: 1  12

Peau sensible  
Pele sensível

REF.04565



Miel  
Mel

REF.04564



d'Aloe Vera  
Aloe Vera

REF.04736



400 ml





800 ml





## Chauffe cire électrique d'épilation Panela cera

u.m.vta: 1		12	
------------	---	----	---

REF. 03321



- Puissance: 110W
- Avec thermostat
- Sans bol
- Convient aux boîtes de 400 et 500 g
- Potência: 110W
- Com termóstato
- Sem recipiente
- Adequado para latas de 400 e 500 g

u.m.vta: 1		60
------------	---	----

REF. RE03321/02

**Pièce de rechange**  
Paças de reposição



u.m.vta: 1		12	
------------	---	----	---

REF. 03322

- Puissance: 175W
- Comprend un bol de 800 g.
- Chauffe rapidement la cire
- Sûr et ergonomique
- Petit format
- Pour les disques, la cire ou les perles, utiliser un bol



- Potência: 175W
- Inclui panela de 800g.
- Aquecimento rápido da cera.
- Seguro e ergonómico
- Leve e de dimensões reduzidas
- Para discos, cera ou pérolas

u.m.vta: 1		60
------------	---	----

REF. RE03322/01

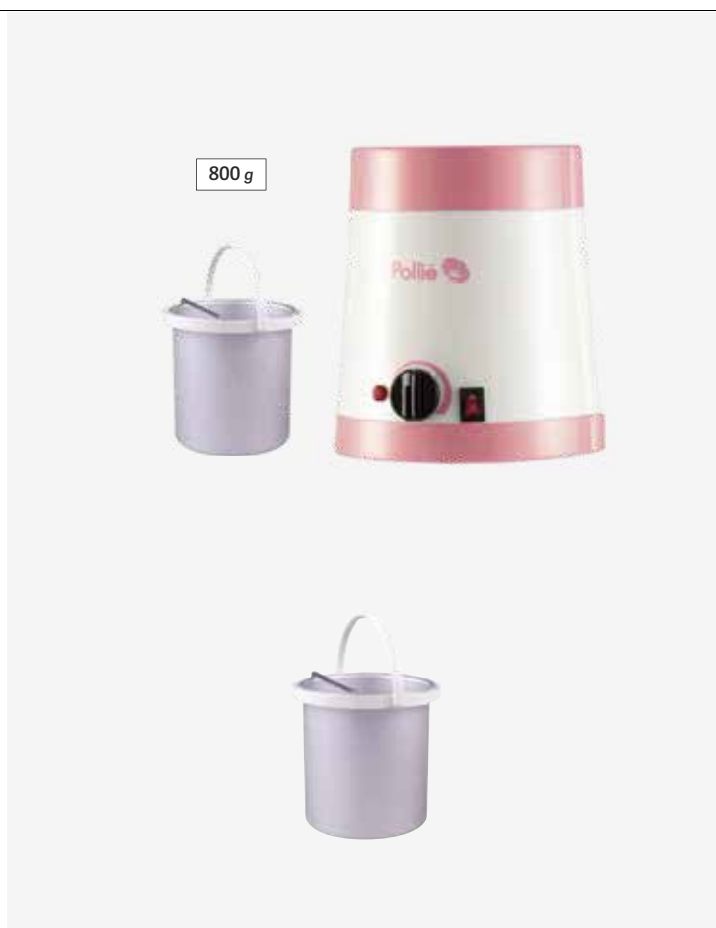
**Pièce de rechange**  
Paças de reposição



**Chauffe cire électrique d'épilation****Panela cera**u.m.vta: 1  12 **REF. 03154**



- Puissance: 80W
- Avec thermostat
- Comprend un bol de 45 g

- Potência: 80W
- Com termóstato
- Inclui recipiente de 450g.

**Collerettes de protection****Círculo protector**u.m.vta: 1  16**REF. 03716**

- Sachet de 100 collerettes
- de protection pot cire à épiler
- Diamètre intérieur: 9,8cm
- Diamètre extérieur: 16 cm
- Diamètre intérieur maximum: 13,5 cm

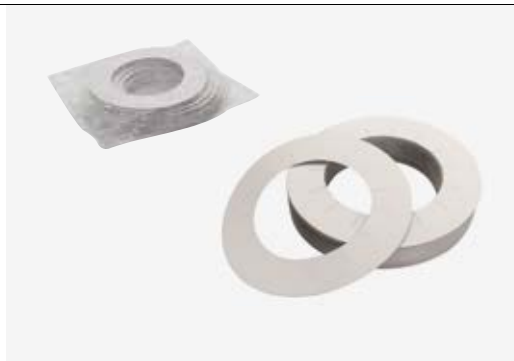
- Saco de 100 círculos protetor
- fundidor cera
- Diâmetro interno: 9,8cm
- Diâmetro externo: 16cm
- Diâmetro interno máximo: 13,5cm

**Chauffes cire****Panela de cera**u.m.vta: 1  12 **REF. 03612**

- Puissance: 90W
- Thermostat électronique de température
- Réservoir en aluminium
- Chauffage rapide de la cire
- Sûr et ergonomique
- Petit format
- Bol inclus avec poignée amovible



- Potência: 90W
- Termóstato eletrónico de temperatura
- Depósito de alumínio
- Aquecimento rápido da cera
- Seguro e ergonómico.
- Leve e de reduzidas dimensões
- Recipiente de metal com pega

u.m.vta: 1  1

250 g

**REF. RE03612/01****Pièce de rechange**  
**Peças de reposição**

## Chauffe cire Pollié avec thermostat Painela cera Pollié com termóstato

u.m.vta: 1  12 



REF. 06614/58



REF. 06614/70



- Puissance: 40W
- Cire 125 ml. Compacte, idéale épiler les petites zones telles que le nez, les oreilles, les sourcils et le contour de la barbe.

- Potência: 40W
- Fusor cera 125 ml. Ideal compacto para depilação de pequenas áreas, como nariz, orelhas, sobrancelhas e contorno de barba.

125 ml

REF. RE06614/01



### Pièce de rechange · Peças de reposição

- Bol cire pour chauffe
- ref. 06614/58, 06614/70 et 04505
- Recipente de cera para painela
- ref. 06614/58, 06614/70 e 04505

**Appareils chauffe-cire électrique****Panela cera**

Idéal pour l'utiliser avec des disques de cire  
 Ideal para utilizar com discos de cera

u.m.vta: 1  1

250 g

REF. 02905

- Puissance: 125W
- Avec thermostat en metal
- Avec filtre
- Potência: 125W
- Com termóstato de metal
- Com filtro

400 g

REF. 02928

- Puissance: 125W
- Avec thermostat en metal
- Avec filtre
- Adapté pour les boîtes de 400 et 500 g
- Potência: 125W
- Com termóstato de metal
- Com filtro
- Adequado para latas de 400 e 500 g

1 kg

REF. 02908

- Puissance: 250W
- Avec thermostat en metal
- Avec filtre
- Potência: 250W
- Com termóstato de metal
- Com filtro

4 kg

REF. 02900

- Puissance: 450W
- Avec thermostat en metal
- Avec filtre
- Potência: 450W
- Com termóstato de metal
- Com filtro



## CHAUFFE-CIRE GAND GANDE PANELA CERA

### Appareils chauffe-cire électrique Panela cera

Idéal pour l'utiliser avec des disques de cire  
Ideal para utilizar com discos de cera

u.m.vta: 1  1

10 kg

**REF. 07821**

- Puissance: 2 x 450W
- Avec thermostats en metal
- Avec filtre
- Potência: 2 x 450W
- Com termóstatos de metal
- Com filtro

12 kg

**REF. 04216**

- Puissance: 2 x 450W
- Avec thermostats en metal
- Avec filtre
- Potência: 2 x 450W
- Com termóstatos de metal
- Com filtro

20 kg

**REF. 04217**

- Puissance: 2 x 450W
- Avec thermostats
- Avec filtre
- Potência: 2 x 450W
- Com termóstatos de metal
- Com filtro



Réchauffeurs de cire d'épilation avec 2 récipients connectés, et avec filtre pour filtrer la cire réutilisable. 2 thermostats indépendants pour chaque récipient.

Panela cera com 2 recipientes interligados e com filtro para filtrar cera reutilizável. 2 Termóstatos independentes para cada recipiente.



## Spatule pour épilation à la cire Espátula cera

u.m.vta: 12  12

Mini  
Mini  
**REF.01627**      **REF.01628**

Petite  
Pequena



**REF.01630**      Moyenne  
Média

**REF.01632**      Gand  
Gande



**REF.01634**      Súper gand  
Super gande



## Boîte de 100 spatules Pacote 100 espátulas

u.m.vta: 1  50 **REF.03282****REF.07114**

## Sachet de 100 spatules Pacote de 100 espátulas

u.m.vta: 1  100 **REF.06651**

**Spatule spéciale pour l'épilation à la cire de 2 mm d'épaisseur**  
**Espátula cera especial 2 mm de espessura**

u.m.vta: 1  50

REF.01636



**Spatule pour l'épilation à la cire avec manche**  
**Espátula cera com cabo**

u.m.vta: 12  12

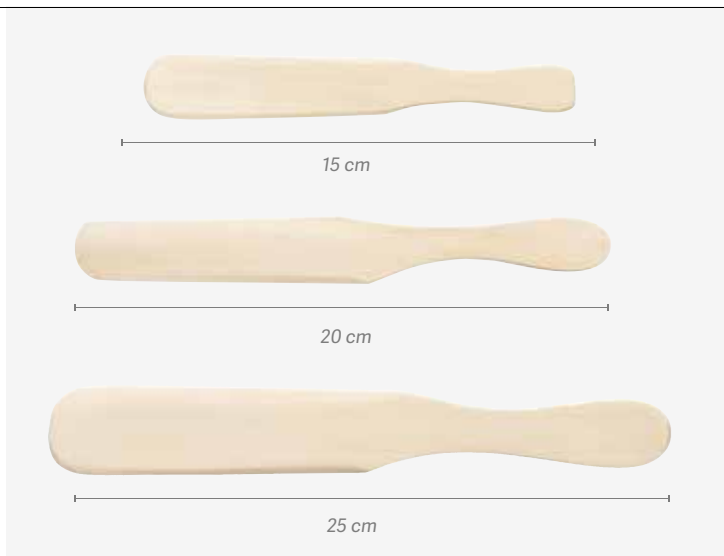

REF.01629



REF.01631

REF.01633

**Spatule Extra Flex en plastique**  
**Espátula Extra Flex em plástico**

u.m.vta: 1  24 

REF.03229



En plastique blanc rigide pour cire et tout type de traitement esthétique.  
 Cor branca. Material plástico rígido para cera ou qualquer tipo de tratamento estético.

REF.03230

Couleur blanche. matière plastique souple.  
 Cor branca. material plástico flexível



**Spatule pour épilation à la cire en métal et en bois**  
**Espátula cera metálica com punho de madeira**



u.m.vta: 1  12 

REF.03469

REF.01419



## Roll-on de Cire Fabriqué en Espagne Cera roll-on feita em Espanha

u.m.vta: 20  20 

Zones de traitement: aisselles, poitrine, dos, bras, abdomen, jambes, visage et aine. Choisissez celui qui convient le mieux au type de cheveux et à la peau: transparent, ultra-crèmeux, coloré, parfumé, etc. Prix échelonnés combinables page 624-625.

Área de tratamento: axilas, tórax, costas, braços, abdome, pernas, rosto e virilha (roll-on facial). Escolha o que melhor se adequa ao tipo de cabelo e pele: transparente, ultra cremoso, com cor, perfumado, etc. Preços escalonáveis combináveis página 624-625.



### Natural - cristallin Natural - cristalino

#### REF.06317

Texture transparente ou semi-transparente, fluide et fort début. Son excellente combinaison de résines de pin le rend idéal pour une épilation parfaite.

*Textura fluida transparente ou semitransparente, forte arranque. Sua excelente combinação de resinas de pinho torna-o ideal para uma depilação perfeita.*

### Bleu- cristallin Azul- cristalino

#### REF.06318

Texture transparente ou semi-transparente, fluide et fort début. Convient à tous les domaines, même les plus sensibles..

*Textura fluida transparente ou semitransparente e forte arranque. Adequado para todas as áreas, mesmo as mais sensíveis.*

### Or - pigments irisé Ouro - pigmentos irisé

#### REF.06321

Texture dense qui favorise l'adhésion et réduit la sensation de chaleur et de douleur. Grâce aux particules dorées, la cire maintient sa température, facilitant l'application et le démarrage.

*Textura densa que promove a adesão e reduz a sensação de calor e dor. Graças às partículas de ouro, a cera mantém sua temperatura, facilitando a aplicação e partida.*



110 g

### Rose - cremosa

#### Rosa - cremosa

110 g

REF.06319

Texture transparente ou semi-transparente, fluide et fort début. Sa texture élastique facilite l'épilation dans tout type de cheveux.

*Textura fluida transparente ou semitransparente e forte arranque. Sua textura elástica facilita a depilação em qualquer tipo de pelo.*

### Chocolat - cremosa

#### Chocolate - cremosa

REF.06320

Texture crémeuse et élastique agréable pour un départ parfait. Pour une épilation douce et efficace, avec un arôme intense de chocolat.

*Textura cremosa e elástica agradável para um começo perfeito. Para uma depilação suave e eficaz, com um aroma intenso a chocolate.*

### Vin - cremosa

#### Vinho - cremosa

110 g

REF.06322

Texture crémeuse et élastique agréable pour un départ parfait. Pour une épilation douce et efficace, laissant la peau légèrement parfumée.

*Textura cremosa e elástica agradável para um começo perfeito. Para uma depilação suave e eficaz, deixando a pele ligeiramente perfumada.*

110 g





**Roll-on de Cire****Roll-on cera**

u.m.vta: 24



24



Le système d'épilation au rouleau est optimal pour les professionnels qui cherchent à obtenir de meilleurs résultats. Les résines avec lesquelles nous fabriquons les cires peuvent être utilisées à une température plus élevée que la cire de basse fusion, avec l'avantage d'être appliquées au moyen d'une bande plus mince. Ainsi, la cire refroidit presque instantanément et la sensation de chaleur dans la peau est minimisée. La cire s'enlève facilement avec les bandes hygiéniques. Prix échelonnés combinables page 626-627 sauf référence 03907.

O sistema roll-on de depilação é ideal para aqueles profissionais que buscam obter os melhores resultados. As resinas com as quais fabricamos as ceras podem ser usadas a uma temperatura mais elevada do que a cera de baixo ponto de fusão, com a vantagem de serem aplicadas por meio de uma tira mais fina. Assim, a cera esfria quase instantaneamente e a sensação de calor na pele é minimizada. A cera é facilmente removida com as tiras higiênicas. Preços escalonáveis combináveis página 626-627 exceto a referência 03907.

**Miel**

Mel

**REF.03704****Talc avec du dioxyde de titane**

Talco com dióxido de titânio

**REF.03705**

100 ml

**Huile d'olive**

Azeite

**REF.03739****Aloe Vera**

Aloé Vera

**REF.03740****Pour Homme**

Homem

**REF.03858****L'azulène**

Azuleno

**REF.04259**

Coco  
Coco

**REF.04678**

Pomme  
Maçã

**REF.04674**

Banane  
Banana

**REF.04677**

Cacao  
Cacao

**REF.03748**

Argan  
Argão

**REF.03706**

Rose pour les peaux sensibles  
au dioxyde de titane  
*Rosa peles sensíveis com  
dióxido de titânio*

**REF.03749**

Faciale  
Facial



24 u

**REF.03907**



## Réchauffeur roll-on avec thermostat interne

### Aquecedor roll-on com termostato interno

u.m.vta: 1  30 

REF. 03379

- Puissance: 15W
- Avec thermostat
- Chauffe cire roll-on avec afficheur latéral de niveau de cire
- Conception ergonomique
- Rapide pour atteindre la température optimale
- Grâce à son design intérieur, il s'adapte à tout type de roll-on
- Thermostat interne qui maintient la température idéale pour l'application de la cire.
- LED Indicatrice de marche-arrêt
- 100-240 V ~
- 50/60 Hz

- Potência: 15W
- Com termostato
- Aquecedor de cera roll-on com indicador lateral de nível de cera
- Design ergonômico
- Rápido em alcançar uma temperatura ideal
- Gaças ao seu design interior adapta-se a qualquer tipo de roll-on
- Termóstato interno que mantém a temperatura ideal para a aplicação da cera
- Led indicador de ligado e desligado
- 100-240V~
- 50/60Hz



## Base chauffe roll on réf. 03379

### Base roll-on réf. 03379

u.m.vta: 1  27

1 roll-on

REF. 03272

- Puissance: 15W
- 100-240V~

- Potência: 15W
- 100-240V~

u.m.vta: 1  18

2 roll-on

REF. 03273

- Puissance: 30W
- 100-240V~

- Potência: 30W
- 100-240V~

u.m.vta: 1  13

3 roll-on



REF. 03274

- Puissance: 45W
- 100-240V~

- Potência: 45W
- 100-240V~



## Chauffe-cire roll on avec thermostat externe Aquecedor roll-on com termostato externo

u.m.vta: 1  9 



**REF. 04091**

- Puissance: 20W
- Avec thermostat
- Chauffe cire avec base pour la stabilité et l'utilisation facile
- Fenêtre pour voir le niveau de la cire
- Régulation de la température de 1 à 6
- Câble de la base 2 mètres
- Chauffage rapide et faible consommation
- Couvercle de protection
- Gâche à son design intérieur, il s'adapte à tout type de roll-on
- Led indicatrice de chauffage
- 100-240 V ~

- Potência: 20W
- Com termostato
- Aquecedor com base para maior estabilidade e facilita a utilização
- Indicador de nível de cera
- Regulação da temperatura de 1 ao 6
- Cabo da base de 2 metros
- Aquecimento rápido e baixo consumo
- Tampa protetora
- Gaças ao seu design interior adapta-se a qualquer tipo de roll-on
- Led indicador de aquecimento
- 100-240V~



## 1 Chauffe-cire roll-on + 1 base chargeur avec base magnétique 1 Aquecedor de cera roll-on + 1 base carregador com base magnética

u.m.vta: 1  6 

**REF. 06623**



- Puissance: 20W
- Capacité: 100 g
- Fréquence: 50 Hz
- Tension 220-240V~
- Base connectable à d'autres bases (jusqu'à 5)
- Fenêtre latérale pour voir le niveau de cire
- Bouton régulateur de température (85°C max)
- Léger et aux dimensions réduites
- Avec capuchon de protection



- Potência: 20W
- Capacidade: 100 g
- Frequência: 50Hz
- Voltagem: 220-240~
- Base conectável a outras bases (até 5 bases)
- Janela lateral para ver o nível de cera
- Controlo regulador de temperatura (85°C máx.)
- Leve e de reduzidas dimensões
- Com tampa protetora





## Kits d'épilation Pollié

### Kits de depilação Pollié

u.m.vta: 1  10 

**REF.03310**

#### Contient · Contém

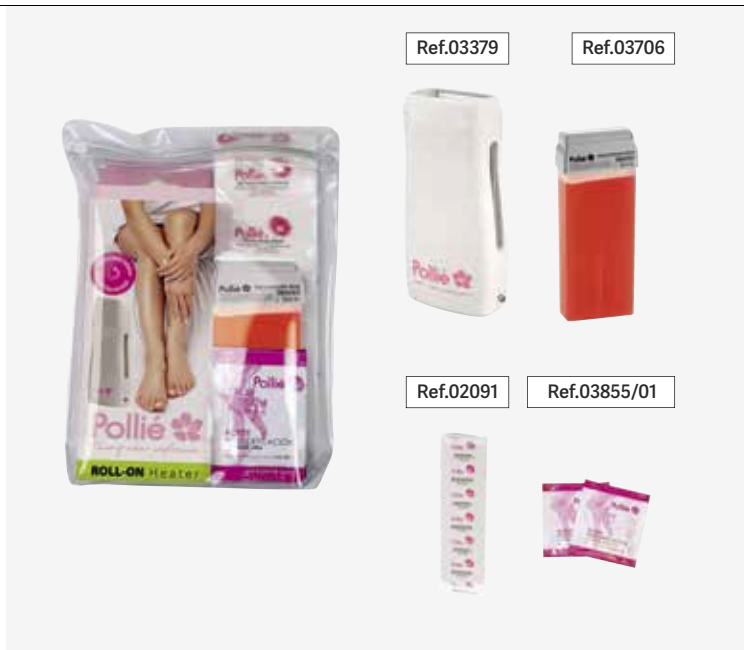

- 1 chauffe-eau 15W
- 1 roll-on Argan
- 1 paquet de 20 bandes d'épilation
- 3 serviettes de l'huile post-épilation

- 1 aquecedor roll-on 15W
- 1 argônio roll-on
- 1 embalagem de
- 20 tiras de depilação
- 3 toalha de óleo pós-depilação



Les trousse d'épilation sont idéales pour une épilation facile et confortable contient tout ce dont vous avez besoin pour une épilation professionnelle à domicile. Pour avoir de belles jambes toute l'année

*Kits de depilação Pollié, ideal para uma depilação fácil e confortável, com tudo que você precisa para depilar profissionalmente em casa. Para pernas lindas o ano todo.*

u.m.vta: 1  9 

**REF.03925**

#### Contient · Contém

- 1 chauffe-eau 20W
- 1 roll-on Argan
- 1 paquet de 20 bandes d'épilation
- 3 serviettes de l'huile post-épilation

- 1 aquecedor roll-on 20W
- 1 argônio roll-on
- 1 embalagem de
- 20 tiras de depilação
- 3 toalha de óleo pós-depilação





**Pack 20 bandes de papier d'épilation POLLié**  
**Pacote 20 tiras papel depilação POLLié**

u.m.vta: 100 100

**85 g/m<sup>2</sup>**  
 • 20 bandes  
 • 20 tiras  
**REF.02091**

u.m.vta: 25 25

**80 g/m<sup>2</sup>**  
 • 100 bandes  
 • 100 tiras  
**REF. 00929**

u.m.vta: 25 25

**90 g/m<sup>2</sup>**  
 • 100 bandes  
 • 100 tiras  
**REF. 02556**



u.m.vta: 50 50



**REF. 04207** 100 bandes  
 100 tiras



**REF. 03804** 100 bandes  
 100 tiras

## Rouleau de papier d'épilation

### Rolo papel depilar

u.m.vta: 1  12 



80 g/m<sup>2</sup>

REF. 06926

- Largeur: 7 cm
- Longueur: 75 m

- Largura: 7 cm
- Comprimento: 75 m



u.m.vta: 1  12 

80 g/m<sup>2</sup>

REF. 03806



- Largeur: 7 cm
- Longueur: 100 m

- Largura: 7 cm
- Comprimento: 100 m



## Pack 100 de bandes de papier épilation ANONYMES

### Pacote 100 tiras papel depilação ANÓNIMAS

u.m.vta: 100  100 

80 g/m<sup>2</sup>

REF. 00929/00

100 bandes  
100 tiras

90 g/m<sup>2</sup>

REF. 02556/00

100 bandes  
Extra-fort  
100 tiras  
Extra forte



80 g/m<sup>2</sup>

REF.03805

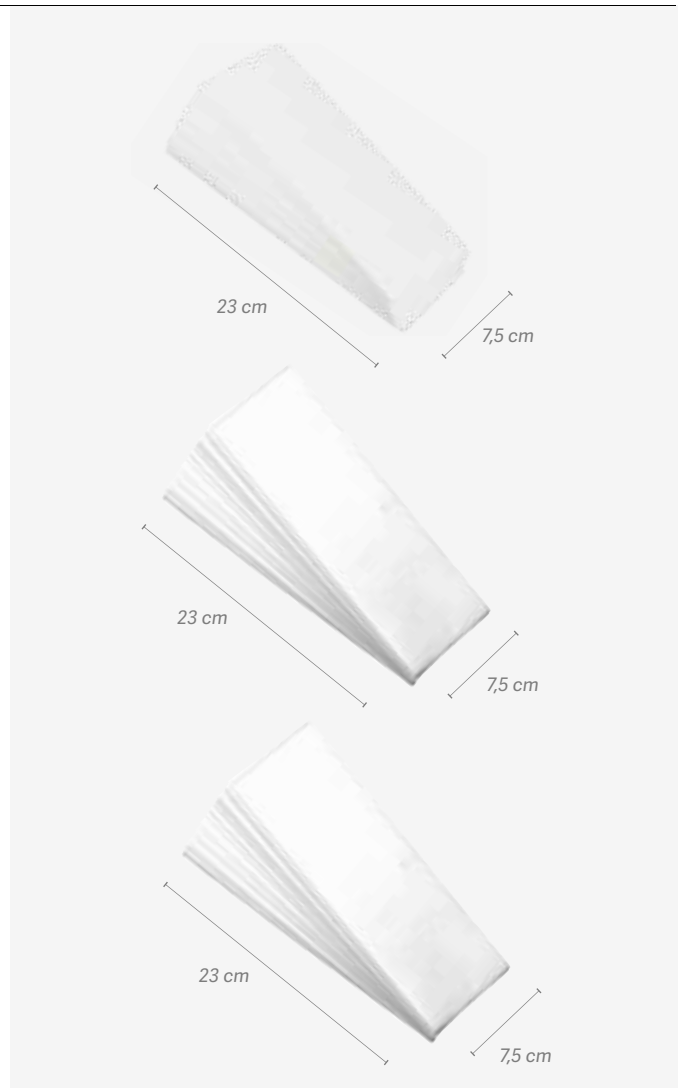
10 bandes  
10 tiras



**Boîte 100 bandes de papier d'épilation extra hypoallergénique**  
**Caixa de 100 tiras papel depilação extra hipoalergénico**

u.m.vta: 1  28 

90 g/m<sup>2</sup>

REF. 06114



Extra : Avoir plus de densité ainsi qu'elle est plus forte et plus résistante.

Fibres étroitement entrelacées qui confèrent au produit une résistance totale à la déchirure et agissent comme une barrière de sorte que la cire ne passe pas.

Extra: mais densidade é mais forte e resistente.

Fibras estreitamente entrelaçadas que dão ao produto uma resistência total e atuam como barreira para que a cera não trespassse.

**Lingettes nettoyantes à l'huile post-épilation**  
**Toalhitas óleo pós-depilação**

u.m.vta: 12  12

Sachet de 5 lingettes  
 Bolsa de 5 toalhitas

2 ml

REF.03855

u.m.vta: 500  500

En vrac  
 A granel

2 ml

REF.03855/01





## Gel post-épilation

### Gel pós-depilação

u.m.vta: 1



6



500 ml

REF.07644

Idéal après tout type d'épilation, y compris l'épilation au laser, en raison de son action régénérante et cicatrisante. Tous types de peau.

- Lissant et hydratant
- Régénérateur
- guérison

*Ideal para após qualquer tipo de depilação, incluindo a depilação a laser, devido à sua ação regeneradora e cicatrizante. Todos os tipos de pele.*

- Suavização e hidratação
- Regenerador
- Cura

## Aloe Vera au calendula

### Aloe Vera com calêndula

500 ml

REF.07645

Idéal après tout type d'épilation, y compris l'épilation au laser, en raison de son action régénérante et cicatrisante. Propriétés anti-inflammatoires et antiseptiques. Tous types de peau.

- Hydratant
- régénérant
- guérison
- Action Anti-Inflammatoire - Antiseptique

*Ideal para após qualquer tipo de depilação, incluindo a depilação a laser, devido à sua ação regeneradora e cicatrizante.*

*Propriedades anti-inflamatórias e anti-sépticas. Todos os tipos de pele.*

- Hidratante
- Regenerando
- Cura
- Ação Anti-Inflamatória - Antisséptico.

## Inhibiteur de cheveux

### Inibidor de cabelo

500 ml

REF.07646

Il ralentit la croissance des cheveux et les affaiblit. Il a des propriétés hydratantes. Tous types de peau.

- Ralentit la croissance des cheveux.
- Il affaiblit les nouveaux cheveux.
- Hydratant



*Retarda o crescimento do cabelo e faz com que ele cresça mais fraco. Possui propriedades hidratantes. Todos os tipos de pele.*

- Retarda o crescimento do cabelo.
- Ele enfraquece o novo cabelo.
- Hidratante.

NEW



**Gel post-épilation**  
**Gel pós-depilação**

u.m.vta: 1  6 



500 ml

- 99% d'aloë Vera
- 99% Aloé Vera

REF.03613



**Huile de post-épilation**  
**Óleo pós-depilação**

u.m.vta: 1  6 

500 ml

- Avec rose musquée
- Parfum de rose

REF.03614



**Boîte de 20 bandes cire froide PEUX SENSIBLES**  
**Caixa 20 bandas de cera fria PELES SENSIVEIS**

u.m.vta: 1  30

REF.03717

Bandes de corps  
Bandas Corporais

u.m.vta: 1  40

REF.03718

Bandes faciales  
Bandas faciais



**Avec des extraits de fruits rouges**  
**Com extratos de frutas vermelhas**



### Boîte 50 aiguilles d'épilation coniques Caixa 50 agulhas depilação cónicas

u.m.vta: 1  20

TIPO K

0,5 mm **Inox**

REF.02965

TIPO K

1 mm **Inox**

REF.02966

TIPO K

1,5 mm **Inox**

REF.02967

TIPO K

0,5 mm **Oro-Gold**

REF.02968

TIPO K

1 mm **Oro-Gold**

REF.02969

TIPO K

1,5 mm **Oro-Gold**

REF.02970



### Aiguilles d'épilation inclinées Agulhas depil. Inclinadas

u.m.vta: 1  20

TIPO K

1 mm **Inox**

REF.03287

- Boîte de 50 aiguilles
- Caixa 50 agulhas



### Nettoyant pour appareils à cire Limpador de aparelhos de cera

u.m.vta: 1  12 

500 ml



REF. 03437

- Dissolvent en spray
- Pour cassolettes et chauffeuses

- Dissolvente em spray
- Panelas e aquecedores



### Gel électroconducteur neutre Gel de eletrocondutor neutro

u.m.vta: 1  4 

5 L

REF. 06694



Le gel de transmission par ultrasons TASSEL est indiqué pour améliorer la conductivité des ultrasons diagnostiques et thérapeutiques. Il est soluble dans l'eau, ne laisse pas de taches. Il peut être utilisé avec tous les appareils à ultrasons disponibles sur le marché. Il s'étale facilement, uniformément et sans se dessécher.

Le gel de transmission par ultrasons TASSEL est destiné à un usage externe sur une peau intacte et sans plaies cutanées. Appliquer le gel sur la zone à traiter. C'est un excellent agent conducteur pour la thérapie par ultrasons, l'imagerie diagnostique et l'épilation au laser.

*O gel de transmissão por ultrassom TASSEL é indicado para melhorar a condutividade do ultrassom diagnóstico e terapêutico. É solúvel em água, não deixa manchas. Pode ser usado com todos os dispositivos ultrassônicos disponíveis no mercado. Ele se espalha facilmente, uniformemente e sem secar.*



*O gel de transmissão por ultrassom TASSEL destina-se ao uso externo em pele intacta e sem feridas. Aplique o gel na área a ser tratada. É um excelente agente condutor para terapia ultrassônica, diagnóstico por imagem e depilação a laser.*

### Gel électroconducteur Gel de eletrocondutor

u.m.vta: 1  6 

1 L

REF. 07616



u.m.vta: 1  1 

5 L

REF. 07617

## Talco TASSEL

### Talcum TASSEL

u.m.vta: 1  6 

200 g

REF. 06429

Talc parfumé extra-fin. Douceur, fraîcheur et nutrition pour la peau. Tassel Talc est adoucissant, hydratant et émollient. Idéal pour le rasage ou l'épilation, les irritations ou les éruptions cutanées, les rougeurs, l'exposition au soleil ou les lésions cutanées. Pas d'allergènes ni de parabens. Testé dermatologiquement.

- Absorbe l'humidité
- Garde la peau fraîche et sèche
- Soulage la peau irritée
- Adoucit



Pó de talco perfumado extra fino. Suavidade, frescura e nutrição para a pele. Talco em pó é suavizante, hidratante e emoliente. Ideal para após o barbear ou depilação, irritações ou erupções cutâneas, ao sol ou lesões na pele. Sem alérgenos e sem parabenos. Testado dermatologicamente.

- Absorve a umidade
- Mantém a pele fresca e seca
- Acalma a pele irritada
- Suaviza



## Distributeur 100 rasoirs jetables Pollié

### Dispensador 100 giletes Pollié descartáveis

u.m.vta: 1  20 

REF. 07440

NEW





Spécialement conçus pour le rasage du corps. Avec sa lame en acier suédois inoxydable de haute qualité et sa tête avec peigne, il permet même de raser les poils sur les parties les plus délicates. Idéal pour l'épilation au laser. Facile à rincer et nettoyer.

Especialmente desenhadas para a depilação corporal. Com as suas lâminas fabricadas em aço inoxidável sueco de alta qualidade e com uma cabeça com pente, permite-nos inclusive rapar os pelos nas partes mais delicadas. Ideais para a depilação a laser. São fáceis de limpar, basta passar por água e limpar.



## 100 rasoirs jetables Pollié

### 100 navalhas descartáveis Pollie

u.m.vta: 1		7	
------------	---	---	---

REF. 02480



## Sachet de 5 rasoirs de sécurité DERBY BODY

### Pacote 5 barbeador DERBY BODY

u.m.vta: 14		112
-------------	---	-----

REF.03828

- Sachet de 5 rasoirs de sécurité, avec un peigne protecteur
- Spécialement conçu pour enlever les poils du corps. Peigne de protection spécial pour un rasage plus facile et plus sûr pour les poil longs
- Idéal pour le rasage avant l'épilation au laser
- Recommandé dans les hôpitaux pour le rasage avant la chirurgie. Tête et manche en polystyrène

- Bolsa de 5 barbeador, com pente protetor
- Especialmente concebida para eliminar pelos do corpo, já que o pente protetor especial proporciona um barbear mais fácil e seguro para os cabelos mais compridos
- Recomendada em hospitais para barbear prévio às cirurgias.
- Cabeçal e cabo em material poliestireno



## Sachet de 5 rasoirs de sécurité DERBY 2

### Pacote 5 máquinas DERBY 2

u.m.vta: 40		40
-------------	---	----

2 lames  
2 lâminas

REF.02948





## Pinces à épiler Pinças de depilar

Solingen

u.m.vta: 12  12**REF.01080**Point de test  
Ponto de teste

8 cm

**REF.00938**Point de test  
Ponto de teste

8 cm

**REF.00937**Point de test  
Ponto de teste

8 cm

**REF.01974**Point de test  
Ponto de teste

8 cm

**REF.00939**Point de test  
Ponto de teste

9 cm

**REF.01081**Point de test  
Ponto de teste

9 cm

**REF.00940**Point de test  
Ponto de teste

9 cm



**Pinces à épiler**  
**Pinças de depilar**

Solingen

u.m.vta: 12 12

**REF.02467**

Point fine  
Ponta fina



Inox

9,5 cm



**REF.02468**

Pointe oblique  
Pointe oblique



**REF.02469**

Pointe plate  
Ponta plana



u.m.vta: 12 12

**REF.01402**

Point fine  
Ponta fina



9 cm



**REF.01403**

Point fine  
Ponta fina



9,5 cm



**REF.01404**

Pointe oblique  
Pointe oblique



9,5 cm



**REF.01405**

Pointe plate  
Ponta plana



9,5 cm

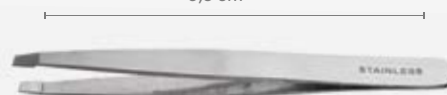

Inox

**Pinces à épiler POLLIÉ**  
**Pinças de depilar POLLIÉ**

u.m.vta: 12  12

Point de test  
 Ponto de teste

**REF.03205**



Pointe plate  
 Ponta plana

**REF.01340**



**REF.02625**



**REF.01341**



**REF.01339**



**REF.02626**



**REF.02793**



**REF.02627**



**REF.02794**



**REF.02795**



Pointe oblique  
 Ponta oblique

**REF.02628**



**REF.02796**



**Pinces à épiler anatomique**  
**Pinças de depilar anatômica**

u.m.vta: 12  12

**REF.02630** Pointe oblique  
 Pointe oblique



9,5 cm

**REF.02500** Pointe oblique  
 Pointe oblique



10 cm

**REF.02629** Pointe plate  
 Ponta plana



9,5 cm

**REF.02631** Point fine  
 Ponta fina



10 cm

**Pinces à épiler**  
**Pinças de depilar**

**REF.02540/50** Pointe oblique  
 Pointe oblique



9 cm

**REF.02742/50** Pointe oblique  
 Pointe oblique



9,5 cm



## Pince à épiler couleurs assorties

### Pinças depilar, diferentes cores

u.m.vta: 12  12

Pointe oblique  
 Pointe oblique



REF.02123



Pointe oblique  
 Pointe oblique



REF.02499

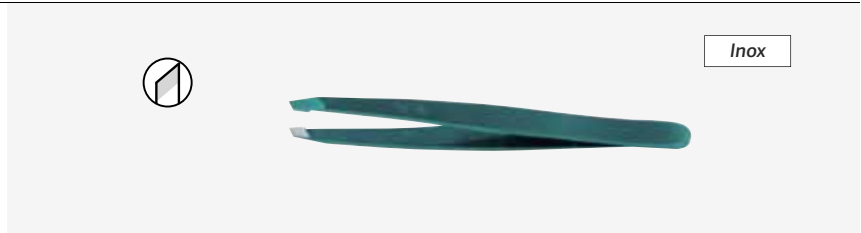

Pointe oblique  
 Pointe oblique



REF.02744/50

REF.02744



Pointe oblique  
 Pointe oblique



REF.02743/50

REF.02743



Pointe oblique  
 Pointe oblique



REF.02742/50

REF.02742

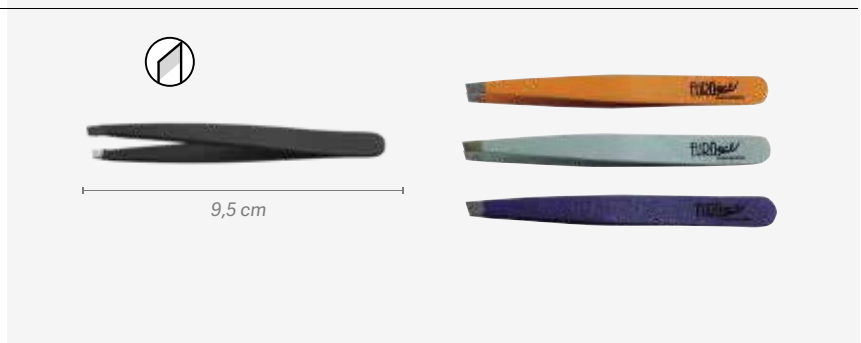

**Présentoir de 24 Pinces à épiler couleurs assorties**  
**Expositor 24 pinças diferentes cores**

u.m.vta: 1  20

Pointe oblique  
 Pointe oblique

**REF.03723**



**Présentoir de 24 Pinces à épiler motif animal**  
**Expositor 24 pinças estampado animal**

u.m.vta: 1  20

Pointe oblique  
 Pointe oblique

**REF.03724**



**Présentoir de 24 Pinces à épiler noires**  
**Expositor 24 pinças cor pretas**

u.m.vta: 1  20

Pointe oblique  
 Pointe oblique

**REF.03725**



04

## Manucure et pédicure Manicure e pedicure

*Vernis à ongles, dissolvant, lampes à manucure, ponceuses à ongles, loupes, limes, pinces...*

*Verniz, removedores, lâmpadas de manicure, tornos de unhas, lupas, limas, alicates...*



## Vernis à ongles Pollié · Esmalte de unhas Pollié

## Comment VERNIR? · Cómo aplicar?

1. Appliquez une base pour protéger les ongles
2. Avant d'appliquer le vernis coloré, il est nécessaire de secouer le contenu un peu, mais vous ne devez en aucun cas le secouer de haut en bas, car le vernis laissera des bulles sur les ongles. L'idéal est de placer la bouteille entre vos mains et de la faire rouler horizontalement. Lorsque vous appliquez le vernis sur les ongles, il est important de le faire à partir du milieu et de l'étendre verticalement.
3. L'application sera faite avec une petite quantité de vernis sur dans le pinceau et en partant de la cuticule jusqu'à la pointe de l'ongle. De bas en haut
4. Pour une plus Grande durabilité, appliquez la couche de finition désirée en scellant l'embout.
5. Pour finir, appliquez de l'huile pour les cuticules et la crème pour les mains

1. Aplique uma base para proteger a unha
2. Antes de aplicar o verniz, é necessário mover o conteúdo um pouco, mas não deve agitá-lo de cima para baixo, porque a tinta deixará bolhas nas unhas. O ideal é colocar nas mãos e enrolar horizontalmente. Ao aplicar a verniz para as unhas, é importante fazê-lo a partir do meio e estendê-lo verticalmente.
3. A aplicação será feita com uma pequena quantidade de na escova e a partir da cutícula até a ponta da unha. De baixo para cima.
4. Para maior durabilidade, aplique a camada superior desejada vedando a ponta.
5. Finalmente, aplique óleo de cutícula e creme para as mãos

## Présentoir vernis à ongles POLLIE

## Expositor vernizes unhas POLLIE

u.m.vta: 1  1

REF.03609

- 3 vernis à ongles x 33 couleurs = 99 vernis à ongles au total
- 1 nuancier
- Présentoir: base + cartouche
- 1 Poster

- 3 vernizes x 33 cores = 99 vernizes no total
- 1 carta de cores Expositor: base
- +carta de cores
- 1 Póster



## Vernis à ongles POLLIE

## Vernizes unhas POLLIE

u.m.vta: 3  3

12 ml

Blanc solide  
Blanco sólido

REF.03505

Blanc  
Blanco

REF.03507

Blanc perle  
Blanco Perla

REF.03503

Glace  
Hielo

REF.03501



## Vernis à ongles POLLIE

### Vernizes unhas POLLIE

u.m.vta: 3  3

12 ml

Beige  
Beige

REF.03497

Sable  
Areia

REF.03513

Rose nude  
Rosa nu

REF.07426

Super Nude  
Sueper Nu

REF.07424

Chameau  
Camel

REF.03422

Rose pastel  
Rosa pastel

REF.03495

Rose pastel  
Rosa pastel

REF.03494

Rose Candy  
Rosa Candy

REF.04477

Rose chewing-gum  
Rosa chicla

REF.03496

Rose fuchsia  
Rosa fúcsia

REF.03504

Amarante  
Amaranto

REF.04479

Terracota  
Terracote

REF.03423

Betterave  
Beterraba

REF.06239

Coral  
Coral

REF.03510

Fraise  
Morango

REF.03511

Rouge passion  
Vermelho paixão

REF.03502

Cerise  
Cereja

REF.07423





## Vernis à ongles POLLIE

### Vernizes unhas POLLIE

u.m.vta: 3  3

Rouge cerise  
Cereja

REF.03490



Rouge métallisé  
Vermelho metalizado

REF.04295



Genat  
Ganada

REF.03493



Chocolat  
Chocolate

REF.03491



12 ml

Jaune  
Amarelo

REF.03859



Doré  
Dourado

REF.04085



Bronze  
Bronze

REF.03499



Vert pastel  
Verde pastel

REF.04227



Vert émeraude  
Verde esmeralda

REF.03860



Vert de la mer  
Verde mar

REF.04569



Vert aiguë-marine  
Verde água-marinha

REF.04478



Vert jade  
Verde Jade

REF.04294



Turquoise  
Turquesa

REF.03509



Vert de genévrier  
Verde zimbro

REF.04570



Vert forêt  
Verde bosque

REF.03420



**Vernis à ongles POLLIE**  
**Vernizes unhas POLLIE**

12 ml

u.m.vta: 3  3

**Vert forêt**  
Selva verde

REF.06240



**Bleu cyan**  
Azul cyan

REF.03861



**Turquoise métalisé**  
Turquesa metalizado

REF.04293



**Bleu métallique**  
Azul metalizado

REF.03508



**Bleu électrique**  
Azul añil

REF.04567



**Lilas perlé**  
Lilás pérolado

REF.03506



**Lila pastel**  
Lilás pastel

REF.04226



**Améthyste**  
Ametista

REF.04568



**Lilas intense**  
Lilás intenso

REF.07425



**Violet**  
Violeta

REF.03421



**Aubergine**  
Beringela

REF.04082



**Argent**  
Prata

REF.04291



**Gis mate**  
Cinza fosco

REF.03512



**Noir**  
Preto

REF.03492



**Paillette argentée**  
Purpurina prata

REF.04084



**Couleurs assorties**  
Purpurina cores

REF.04086



**Soins des ongles POLLIÉ**  
**POLLIÉ tratamentos de unhas**

12 ml

u.m.vta: 3  3

Top Coat "mat" séchant  
 Top Coat "mate" secante

REF.03913



Top Coat effet "gel"  
 Top coat efeito "gel"

REF.04261



Type de couche. Brillant asséchant  
 Tipo coat . Brilho secante

REF.03518



Base de vitamine  
 Base vitaminada

REF.03514



Anti stries  
 Anti-estrias

REF.03515



Durcisseur  
 Endurecedor

REF.03516



Gel elimine cuticules  
 Remove-cutícula gel

REF.03517



**Vernis à ongles fluor**  
**Verniz de unhas flúor**

u.m.vta: 3  3

12 ml

**NEW**

Bleu  
 Azul

REF.07489



**NEW**

Rose  
 Rosa

REF.07490



**NEW**

Orange  
 Laranja

REF.07491



**NEW**

Jaune  
 Amarelo

REF.07492



### Nuanciers vernis à ongles POLLIE

#### POLLIE carta cores vernizes de unhas

u.m.vta: 1  150

Comprend 4 roues de couleurs  
Inclui 4 rodas com cores

**REF.06580**

### Spray séchant pour ongles

#### Spray secante de unhas

u.m.vta: 1  12 

200 ml

**REF.06693**

Il accélère le séchage du vernis, rehausse sa brillance et évite sa détérioration. Vaporiser sur les ongles fraîchement peints, en écartant les doigts, à une distance de 15 centimètres.

Acelera a secagem do verniz, realça o seu brilho e evita a deterioração do verniz. Vaporizar sobre as unhas recém pintadas, separando os dedos e a uma distância de cerca de 15 centímetros.

### Kit vernis à ongles "back to basics"

#### Kit vernizes unhas "back to basics"

u.m.vta: 1  6

4 x12 ml

**REF.07154**

Ref. 1ud - 03423  
Ref. 1ud - 03501  
Ref. 1ud - 03502  
Ref. 1ud - 04477



### Kit de vernis à ongles Manucure française

#### Kit vernizes de unhas Manicure francesa

u.m.vta: 1  6

4 x12 ml

**REF.03863**

Ref. 1ud - 01200 lima  
Ref. 1ud - 00123 Baja pieles  
Ref. 1ud - 03514  
Ref. 1ud - 03495  
Ref. 1ud - 03507  
Ref. 1ud - 03528



### PAS À PAS P-LACK · PASSO A PASSO P-LACK

1. Appliquez une fine couche de base de P-Lack, sans toucher les cuticules ni le contour de l'ongle. Scellez bien le bord du clou avec la même base. Effectuez cette opération de la première main et séchez / polymérisez avec une lampe UV pendant 120 secondes ou avec une lampe à LED pendant 90 secondes. Répétez avec l'autre main.
2. Appliquez ensuite une fine couche de couleur P-Lack, en évitant les cuticules et le contour de l'ongle. Scellez bien le bord de l'ongle avec la même couleur. Effectuez cette opération de la première main, séchez et polymérisez avec une lampe UV pendant 120 secondes ou avec une lampe LED pendant 90 secondes. Répétez cette opération avec l'autre main.
3. Appliquez une seconde couche mince de P-Lack Color en suivant les mêmes indications que dans la première couche. Très important pour bien sceller le bord du clou.
4. Pour une plus longue durée avec une finition parfaite et brillante, nous appliquerons une fine couche de P-Lack Gloss en suivant les mêmes indications que dans les cas précédents.
5. Pour terminer: enlevez les résidus collants et dégraisser les ongles en humidifiant une lingette en cellulose avec Nail Cleaner, nettoyant ongle. Finition brillante et sans parties opaques.
6. Appliquez de l'huile sur les cuticules et l'hydratant

1. Aplique uma capa fina de base P-Lack, sem tocar nas cutículas ou no contorno da unha. Selar bem a borda da unha com a mesma base. Realize esta operação na primeira mão e seque com uma lâmpada UV por 120 segundos ou com uma lâmpada LED por 90 segundos. Repita com a outra mão.
2. Em seguida, aplique uma capa fina de cor P-Lack, sem tocar nas cutículas ou no contorno da unha. Selar bem a borda da unha com a mesma cor. Realize esta operação na primeira mão e seque com uma lâmpada UV por 120 segundos ou com uma lâmpada LED por 90 segundos. Repita esta mesma operação com a outra mão.
3. Aplique uma segunda capa fina de P-Lack Color seguindo as mesmas indicações da primeira capa. Muito importante para selar bem a borda da unha.
4. Para uma duração mais longa com um acabamento perfeito e brilhante, aplicaremos uma fina camada de P-Lack Gloss seguindo as mesmas indicações dos casos anteriores.
5. Para finalizar: remova os resíduos pegajosos e desengaxe as unhas, umedecendo um lenço de celulose com o Limpador de Unhas, limpando a unha. Final de acabamento brilhante e sem partes opacas.
6. Aplique óleo nas cutículas e hidratante

### Nuancier couleurs P-LACK Carta cores P-LACK

u.m.vta: 1  100



REF.06558





**Vernis à ongles semi-permanent P-LACK**  
**Vernizes semipermanente P-LACK**

9 g

u.m.vta: 1  6 



Dark Sky

REF.06247



Flames

REF.06246



Dark Rouge

REF.06245



Summer Fire

REF.06248



Violet Arrow

REF.06249



Pink Candy

REF.06250



Barbies dress

REF.06251



Pink Ribbon

REF.06253

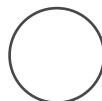

Pure White

REF.06254



Geen Paradise

REF.06255



Clear Pink

REF.06256



Clear White

REF.06257



Chestnut

REF.06258





Baby Doll

REF.06262



**Vernis à ongles semi-permanent P-LACK**  
**Vernizes semipermanente P-LACK**

9 g

u.m.vta: 1  6 



Top Coat

**REF.06260**



Top coat no wipe

**REF.07117**



Base

**REF.06261**



Black

**REF.06244**



Violet

**REF.06592**



Wine

**REF.06593**



French  
Pink

**REF.06594**



Red Ferrari

**REF.06595**



Violet

**REF.07476**



Vert fluo  
Verde neon

**REF.06942**



Orange fluo  
Laranja neon

**REF.06943**



Jaune fluo  
Amarelo neon

**REF.06944**





Rose fluo  
Rosa neon

**REF.06945**



## Nail primer POLLIÉ

### Pollié nail primer

u.m.vta: 1  6 

7 ml

REF.06673

Vernis à ongles pour assurer une adhérence parfaite du gel et de l'acrylique. Contient des acides.

#### MODE D'EMPLOI :

1. Préparer les ongles.
2. Primer : appliquer une fine couche et laisser sécher à l'air
3. Appliquer le gel de construction ou acrylique, et poursuivre la procédure.

### Acid free

7 ml

REF.07116

*Para assegurar a perfeita aderência do gel e do acrílico. Contém ácidos.*



#### COMO UTILIZAR:

- 1. Preparar as unhas.
- 2. Primeiro: aplicar uma capa fina e deixar secar ao ar
- 3. Aplicar o gel de construção ou acrílico e continuar com o processo.



## Préparation des ongles P-LACK

### Preparação de unhas P-LACK

u.m.vta: 1  6 



15 ml

REF.07421



## Vernis à ongles base/top

### Nail polish base/topcoat

u.m.vta: 1  6 

9 g

REF.06674

Produit 2 en 1 transparent : base + top pour gel acrylique. Il doit être appliqué comme base avant le gel acrylique et après comme top pour terminer

*Produto 2 em 1 transparente: base e top para o acrílico gel. Aplica-se como base antes do gel acrílico e depois como top para finalizar.*



## Acrylique gel Gel acrílico

u.m.vta: 1  12

60 g

REF.06597

Rose transparent  
*Rosa transparente*

60 g

REF.06598

Blanc  
*Branco*

60 g

REF.06599

Claire  
*Claro*

60 g

REF.06600

Camouflage  
*Camuflagem*

60 g

REF.06601

Rose intense  
*Rosa intenso*



Le gel acrylique est la combinaison parfaite entre la technique de l'acrylique et du gel.

MODO DE USO:

- Le meilleur de l'acrylique: force, durabilité et dureté maximale avec une sculpture parfaite
- Le meilleur du gel: souplesse, sans odeur, sans monomère, propre et facile à remplir. Disponible en 5 couleurs



O Gel Acrílico é a combinação perfeita entre a técnica de acrílico e gel.

COMO UTILIZAR:

- O melhor do acrílico: resistência, durabilidade e dureza máxima com a melhor escultura
- O melhor do gel: flexibilidade, sem odor, sem monômeros, limpo e fácil de encher. Disponível em 5 cores

## Préparation des ongles P-LACK

### Preparação de unhas P-LACK

u.m.vta: 1  16 

REF.07422

## Dissolvant P-LACK

### Removedor P-LACK

REF.06263

- Acétone pure
- Parfum orange
- Acetona pura
- Perfume de laranja

## Nettoyeur à ongles



### Limpador unhas

REF.06283



## Dissolvant huileux rose

### Removedor de verniz cor-de-rosa oleoso

u.m.vta: 1  19 

150 ml

REF.06608

Dissolvant d'émail à l'acétone enrichi en huile de ricin. Enlève le vernis à ongles en douceur en les laissant brillants et parfumés

Removedor de verniz com acetona enriquecida com óleo de ricino. Remove verniz delicadamente deixando brilhantes e perfumadas as unhas.

## Dissolvant de vernis à ongles



### Removedor de verniz

u.m.vta: 1  19

150 ml

REF.07172

À l'huile de ricin qui hydrate les cuticules  
Com óleo de ricino que hidrata as cutículas

u.m.vta: 1  12 

1 L

REF.06607

- Avec de l'acétone
- Com acetona



u.m.vta: 1  12

1 L

REF.07173

- Sans de l'acétone
- Sem acetona



### Dissolvant P-LACK Removedor P-LACK

u.m.vta: 1  19 

150 ml

REF.07109



u.m.vta: 1  12 

1 L

REF.07110





### Nettoyeur à ongles (nettoyant / dégraissant) Limpador unhas (limpador / desengordurante)

u.m.vta: 1  19 

150 ml

REF.07111

u.m.vta: 1  24 

400 ml

REF.07112





### Pot de 10 trempes doigts individuels Conjunto 10 mergulha dedos individuais

u.m.vta: 1  12

REF.03879

- Ne pas utiliser avec un dissolvant de vernis à ongles sans acétone
- Não use com removedor de esmalte sem acetona



### Feuilles enveloppées pour enlever 100 unités Folhas envolvidas para remover 100 unidades

u.m.vta: 1  107

100 u



REF.04824

Feuilles de papier d'aluminium avec coton incorporé pour être facile et pratique à appliquer avec le dissolvant ou l'acétone sur l'ongle.

Folhas de papel alumínio com algodão incorporado para serem fáceis e convenientes de aplicar com o removedor ou acetona na unha.



### Crème mains ultra-hydratante et nutritive Crema para as mãos ultra hidratante e nutritiva

u.m.vta: 1  6 

Avec doseur  
Com doseador

500 ml

REF.07083

Une crème ultra-hydratante et nutritive sans sensation grasse, qui enveloppe les mains d'un voile réparateur doux et puissant.

**L'Huile de Rose Musquée** est un régénérateur extrêmement puissant pour notre peau.

- Elle agit à la surface de la peau comme facteur humidifiant naturel et améliore l'hydratation.
- Elle nourrit et régénère.
- Elle réduit la perte en eau de notre épiderme en renforçant et en multipliant la barrière de céramides.
- Elle corrige et prévient les problèmes cutanés liés au photo-vieillissement, grâce à l'auto-génération de mélanine.
- Elle revitalise le fibroblaste, qui est la cellule dermique protectrice du collagène, acide hyaluronique, élastine et responsable de la fermeté et de l'élasticité de notre peau.

Um creme ultra hidratante e nutritivo sem sensação de oleosidade que envolve as mãos num suave e poderoso véu reparador.

O **Óleo de Rosa Mosqueta** é um poderosíssimo regenerador para a nossa pele.

- Atua de forma superficial como fator natural humectante, melhorando a hidratação.
- Nutre e regenera.
- Reduz a perda de água na nossa epiderme, já que reforça e multiplica a barreira de ceramidas.
- Corrige e previne os problemas cutâneos causados pelo fotoenvelhecimento, através da autogeração de melanina.
- Revigoriza o fibroblasto, que é a célula dérmica produtora do colagénio, ácido hialurónico, elastina e responsável pela firmeza e elasticidade da nossa pele.



u.m.vta: 1  17 

100 ml

REF.07082



**Pinceau éventail avec poils synthétiques**  
**Pincéis ventilador de cabelo sintético**

u.m.vta: 1  12 

REF.07097





REF.07098



- Grand
- Grande

**Pinceaux à ongles acryliques kolinsky**  
**Pincéis unhas acrílicas kolinsky**



u.m.vta: 1  12 

Pinceaux à ongles en acrylique avec des poils. Connus pour leur résistance et sa durée, et aussi par leur Grande élasticité et leur absorption maximale du produit

*Considerado o melhor pêlo para pincéis de unhas acrílicas pela sua resistência e duração, pela sua Grande elasticidade e máxima absorção do produto*



**Pinceaux à ongles gel**  
**Pincéis unhas gel**

u.m.vta: 1  12 



- Poils en nylon
- Cerdas de nylon

Les ongles en gel ne sont pas fabriqués avec le même pinceau utilisé pour les ongles en acrylique. N'oubliez pas que plus le numéro de votre pinceau est Grand, plus son épaisseur est Grande. Si vous souhaitez sculpter des ongles en gel, vous devez utiliser des brosses spéciaux qui facilitent la mise en place du gel. Pour cette raison, des pinceaux très différents sont utilisés. Actuellement, les pinceaux utilisés pour appliquer le gel sont en nylon (synthétique). CHEVEUX SYNTHETIQUES, VIROLA ALUMINIUM, MANCHE EN BOIS

*Lembre-se, quanto maior o número do seu pincel, maior a espessura. Se quiser esculpir as unhas em gel, deve usar pincéis especiais que facilitam a colocação do gel. Isso ocorre porque o gel é diferente do acrílico. Por esse motivo, são usadas escovas muito diferentes. Atualmente os pincéis usadas para aplicar gel são de nylon (sintéticas). CERDAS SINTÉTICAS, VIROLA ALUMÍNIO, PUNHO DE MADEIRA*

**Set de 6 pinceaux décoration ongles**  
**Set 6 pincéis decoração unhas**



u.m.vta: 1  12

Cheveux synthétiques  
 Cerdas sintéticas

**REF.03653**



**Pinceau gel + repousse-cuticules**  
**Pincel gel + empurrador de cutículas**



u.m.vta: 1  12 

**REF.06760**



**Nail art**

**Stylo dotting pour ongles**  
**Pincel dotting para unhas**



u.m.vta: 1  12 

**REF.06761**



**Nail art**

**Stylo gradient pour ongles**  
**Pincel gradient para unhas**

u.m.vta: 1  12 



4 Têtes de rechange  
 4 Pontas

**REF.06762**



**Nail art**

**Support de pinceaux noir**  
**Suporte cor preto de pincéis**

u.m.vta: 1  12 

**REF.04822**



**Set NAIL ART**  
**Conjunto NAIL ART**

u.m.vta: 1  42

**REF.06759**

- 15 Pinceaux à ongles
- 5 Stylos à double tête en métal
- 15 Pincéis para unhas
- 5 De dupla ponta de metal



## Manucures originales Manicures originais





Avec les poinçons, vous pouvez décorer les ongles et faire un nombre infini de formes, de lignes, de points, de fleurs, le tout dans des couleurs différentes. Les pinceaux à pointe fine vous aideront à faire ces petits détails qui feront de vos ongles une petite œuvre d'art.

Pode decorar as unhas e fazer um número infinito de formas, linhas, pontos, flores, tudo em cores diferentes. Com uma ponta fina vai ajudar a fazer esses pequenos detalhes que farão das suas unhas uma pequena obra de arte.

### Set de 5 poinçons de décoration d'ongles

#### Decoração unhas



u.m.vta: 1  12 

REF.04093



### Roue strass rhinestone nail art

#### Strass rhinestone nail art

u.m.vta: 1  12 



600 u

REF.06774



### Roue fimo nail art fleurs et fruits

#### Fimo nail art flores e frutas



u.m.vta: 1  12 

144 u

REF.04835



**Roue strass rhinestone de couleurs nail art**  
**Strass rhinestone cores nail art**

u.m.vta: 1  12 

- Mini
- Mini

600 u

REF.07347



600 u

REF.07345



**Roue strass rhinestone argent nail art**  
**Strass rhinestone prata nail art**

144 u

REF.07346



**Donuts strass nail art rueda**  
**Donuts rhinestones nail art rueda**

144 u

REF.07342



**Roue nail art sequins strass**  
**Sequins rhinestones nail art wheel**

144 u

REF.07343



**Carrousel Peace & Love**  
**Carrousel de paz e amor**

144 u

REF.07352



### Autocollants 3d Adesivos 3d

u.m.vta: 1  12 

- Cœurs blancs
- Corações

**REF. 04831**



- Papillons blancs
- Borboletas brancas

**REF.04832**



- Fleurs blanches
- Flores brancas

**REF.04833**





- Fleurs de couleurs
- Flores de cores

**REF.04834**



### Feuille pour ongles 1,5 m Folha de decoração para unhas 1,5 m

u.m.vta: 1  12 

**REF.06770**

Noir  
Cor preto

**REF.06768**

Dorée  
Dourada

**REF.06769**

Argentée  
Prateada

06770



06768





06769





### Bande adhésive pour ongles 0,8 mm fita adesiva para unhas 0,8 mm

u.m.vta: 1  12 

Noir  
Preta

REF.06773

Dorée  
Dourada

REF.06771

Argentée  
Prateada

REF.06772



### Décoration nail art Decoração arte

u.m.vta: 1  12 

Fleurs sèches . 12 couleurs  
Flores secas.12 cores

REF.06763



Glitter variés. 1 g x 12 couleurs  
Glitter sortidos. 1 g x 12 cores

REF.06764



REF.06765

- Poudres assortiments velours
- 0,5 g x 12 couleurs
- Pós sortidos de veludo
- 0,5 g x 12 cores

REF.06766

- Glitter écailles sirène
- 1 g x 12 couleur
- Glitter escama sereia
- 1 g x 12 cores



REF.06767

- Feuille d'or
- 12 Couleurs
- Folhas de ouro
- 12 cores cores



## Décoration nail art

### Decoração arte

u.m.vta: 1  12 

**REF.07344**

- Boules Nail Art Caviar Micro Cristal
- 1,5g x 12
- Bolas de Nail Art Microcristal de caviar
- 1,5g x 12



**REF.07348**

- Glitter powder glitter nail art
- 1,5 g x 12 couleurs
- Glitter powder glitter nail art
- 1,5 g x 12 cores



**REF.07349**

- Poudres de sable pour nail art
- 1,5 g x 12 couleurs
- Pós de areia para Nail Art
- 1,5g x 12 cores



**REF.07350**

- Glitter nail art assorti
- 1,5 g x 12 couleurs
- Diversos purpurina Nail Art
- 1,5g x 12 cores



**REF.07351**

- Losanges en paillettes
- 1,5 x 12 g
- Losangos em flocos brilhantes
- 1,5 x 12 g



**REF.07382**

- Palette nail art nacré
- Paleta de Nail Art Perolada



## Moule à ongles Molde para unhas

u.m.vta: 1	 32	u.m.vta: 1	 21
------------	--	------------	--

500 u

REF.04825

500 u

REF.04827

u.m.vta: 1	 57
------------	--

500 u

REF.04826





- Rectangulaire
- Retangular

- Fer à cheval moyens
- Médios

- Double épaisseur
- Dupla espessura



## Distributeur transparent pour moules à ongles Dispensador transparente para moldes de unhas

u.m.vta: 1	 4	
------------	---	---

REF.04828



## Moules pour ongles réutilisables Moldes para unhas reutilizáveis

u.m.vta: 1	 12	
------------	--	---

5 u

REF.06750



**Bandes de guidage pour french manucure**  
**Guias para french manicure**

u.m.vta: 1  50

**REF.04829**

- Formes
- Formas



**REF.04830**



**Tips pour ongles**  
**Tips para unhas**

u.m.vta: 1  46

100 u

**REF.06743**

- Naturels square
- Naturais square



100 u

**REF.06744**

- Naturels courbés
- Naturais curvados



100 u

**REF.06745**

- Blancs square
- Brancos square



100 u

**REF.06746**

- Blancs courbés
- Brancos curvados



100 u

**REF.06747**

- Transparents square
- Transparentes square





100 u

**REF.06748**

- Transparents courbés
- Transparentes curvados



**Palette de mélange en plastique pour nail art**  
**Paleta de mistura plástico para nail art**



u.m.vta: 1  50 

REF.07477

**NEW**



**Palette de mélange en métal pour nail art**  
**Paleta de mistura de metal para nail art**



u.m.vta: 1  50 

REF.07478

**NEW**



**Sachet de 10 palettes pour démo**  
**Pacote de 10 paletes para demo**



u.m.vta: 1  15 

Naturelle  
 Natural

REF.06751

06751



u.m.vta: 1  15 



Transparente  
 Transparente

REF.06752

06752





### Main articulée pour entraînement de manucure Mão articulada para práticas de manicure

u.m.vta: 1		10	
------------	---	----	---

REF.07080



### Recharge Peças de reposição

u.m.vta: 1		12	
------------	---	----	---

REF.07081

- Sachet de 100 ongles
- Pacote de 100 unhas

### Main malléable pour manucure Mão práticas manicure

u.m.vta: 1		50
------------	---	----

REF.04356

- Convient pour sécher les lampes
- Adequado para lâmpadas de secagem



u.m.vta: 1		20
------------	---	----



REF.04353

- Convient pour sécher les lampes
- Avec support
- Adequado para lâmpadas de secagem
- Com suporte



## Cellulose prédécoupée

### Celulose pré-cortada

u.m.vta: 1  12 

**REF. 03060**



- Anonyme
- Anônimo

**REF. 03060/00**



Sachet de 2 rouleaux de cellulose. 500 carrés 4 x 5 cm. Super absorbants. Idéal pour enlever le vernis. Ne peluche pas. Ø 15 · Poids: 155 g. Tolérance 15 g.

Saco com 2 rolos de celulose pré-cortada em pedaços de 4 x 5 cm. Cada rolo é de 500 unidades. de pensos absorventes. Ideal para remove. Ø 15 · Peso: 155 g. Tolerância 15 g.

## Distributeur+ 1000 pad nail

### Dispensador + 1000 pad

u.m.vta: 1  12

**REF.06471**



Carrés prédécoupés. Ne peluche pas. Idéal pour enlever le vernis avec du dissolvant ou la couche de gaisse du vernis semipermanent.

Quadrados pré-cortados confortáveis de usar. Ideal para remover com acetona ou semi-permanente.



## Bande de protection

### Tips para unhas

u.m.vta: 1  12 



- Rose
- Rosa

**REF.06757**



## Godet forme tube

### Godé forma tubo



u.m.vta: 1  12 

- En plastique
- De plástico

**REF.06758**



### Réceptier pour manucure Copinho para manicure

u.m.vta: 1  160 

- En verre
- De cristal

REF.06756



### Réceptier blanc avec bouchon en liège Recipiente cerâmico com tampa de cortiça

u.m.vta: 1  48

- Blanc
- Branco

REF.06775



### Clips soak off remover 10 u Clipes soak off remover 10 un

u.m.vta: 1  106

- Blancs
- Brancos

REF.06777





- Rose
- Rosas

REF.06778



### Lampe uv-led pour ongles Catalisador de unhas uv-led

u.m.vta: 1  12 

REF. 07186



SCAN  
ME!

- Puissance: 65 W
- Poids: 450g
- Ampoule à LED UV: 33 unités
- Longueur d'onde des leds : 395-405nm
- Tension: 100-240V ~
- Fréquence : 50/60 Hz
- Minuterie: 10", 30", 60" et 99".
- Adaptateur de sortie: DC 24 V = 2A
- Température de fonctionnement: -10 °C à -35 °C
- Support métallique amovible aimanté.



- Potência: 65W
- Peso: 450 g
- Lâmpadas Led/UV: 33 unidades
- Comprimento de onda Leds: 395-405nm
- Voltagem: 100-240V
- Frequência 50/60 Hz
- Temporizador: 10", 30", 60" e 99" segundos
- Saída do Adaptador: DC 24V = 2A
- Temperatura de trabalho: -10°C a -35°C.
- Base metálica removível magnetizada.



Nous présentons nos lampes UV LED 48W (Ref.06638, modèles MOON LIGHT et 06639, SUN LIGHT), elles sont le complément idéal pour le séchage rapide et sûr des vernis à ongles semi-permanents et des gels de reconstruction manucure / pédicure, spécialement formulé pour le séchage des LED.

Apresentamos as nossas lâmpadas LED UV de 48W (Ref.06638 modelo MOON LIGHT e 06639 modelo SUN LIGHT), são o complemento ideal para a secagem rápida e segura da varniz de unhas semi-permanentes e géis de reconstrução de manicura / pedicura, bem como Especialmente formulado para secagem por LED.

### Lampe uv-led pour ongles Catalisador de unhas uv-led

u.m.vta: 1  12 



REF. 06638



SCAN  
ME!

- Puissance: 48W
  - Poids: 450g
  - Ampoule à LED UV: 21 unités
  - Longueur d'onde des leds : 395-405nm
  - Tension: 100-240V ~
  - Fréquence : 50/60 Hz
  - Minuterie: 30 ", 60" et 99 "
  - Adaptateur de sortie: DC 24 V / 1,5 A
  - Température de fonctionnement: -10 °C à -35 °C
- Potência: 48W
  - Peso: 450 g
  - Lâmpadas Led/UV: 21 unidades
  - Comprimento de onda Leds: 395-405nm
  - Voltagem: 100-240V
  - Frequência 50/60 Hz
  - Temporizador: 30", 60" e 99" segundos
  - Saída do Adaptador: DC 24V/1.5 A
  - Temperatura de trabalho: -10°C a -35°C.

### Lampe uv-led pour ongles Catalisador de unhas uv-led

u.m.vta: 1  8 

REF. 06639





SCAN  
ME!

- Puissance: 48W
  - Poids: 560 g
  - Ampoule à LED UV: 24 unités
  - longueur d'onde des Leds : 395-405nm
  - Tension: 100-240 V ~
  - Fréquence 50/60 Hz
  - Minuterie: 10 ", 30", 60 "et 99" secondes
  - Adaptateur de sortie: DC 24V / 1.5A
  - Température de fonctionnement: 0°C à 40°C
  - Base détachable
- Potência: 48W
  - Peso: 560 g
  - Lâmpadas Led/UV: 21 unidades
  - Comprimento de onda Leds: 395-405nm
  - Voltagem: 100-240V
  - Frequência 50/60 Hz
  - Temporizador: 30", 60" e 99" segundos
  - Saída do Adaptador: DC 24V/1.5 A
  - Temperatura de trabalho: -10°C a -35°C.
  - Base destacável

Nous présentons nos lampes UV à LED 48W (Ref.06640, modèles POWER LIGHT et 06641, FAST LIGHT), elles sont le complément idéal pour le séchage rapide et sûr des vernis à ongles semi-permanents et des gels de reconstruction manucure / pédicure, ainsi que Spécialement formulé pour le séchage des LED.

Apresentamos nossas lâmpadas LED UV de 48W (Ref.06640 modelo POWER LIGHT e 06641 modelo FAST LIGHT), são o complemento ideal para secagem rápida e segura da varnish de unhas semi-permanentes e géis de reconstrução de manicure / pedicure, bem como Especialmente formulado para secagem por LED.

### Lampe UV-led pour ongles modèle: POWER LIGHT Catalisador de unhas IV-led modelo: POWER LIGHT

u.m.vta: 1  8 

REF. 06640

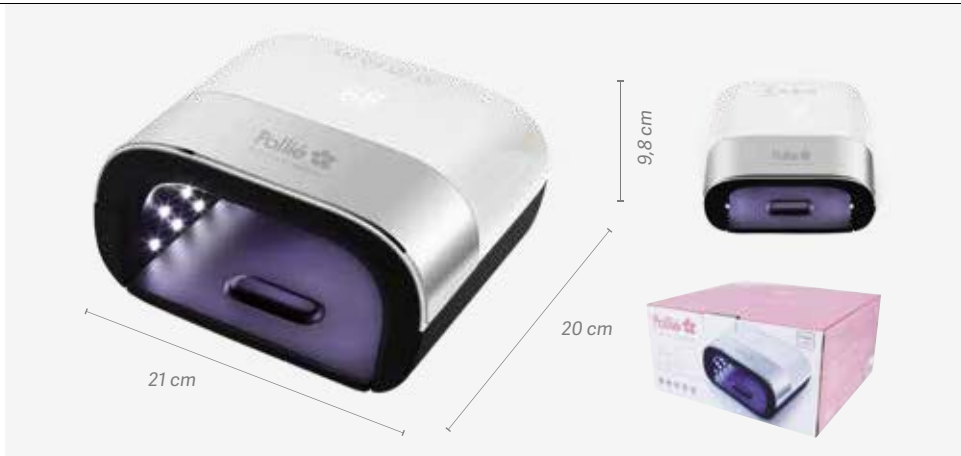



SCAN  
ME!

- Puissance: 48W
- Poids: 880 g
- Ampoule à LED UV: 36 unités
- longueur d'onde des Leds : 395-405nm
- Tension: 100-240 V ~
- Fréquence 50/60 Hz
- Minuterie: 30", 60 "et 99" secondes
- Adaptateur de sortie: DC 24V / 1.5A
- Température de fonctionnement: -10°C à -35°C
- Base amovible
- Pour manucure et pédicure

- Potência: 48W
- Peso: 880 g
- Lâmpadas Led/UV: 36 unidades
- Comprimento de onda Leds: 395-405nm
- Voltagem: 100-240V
- Frequência 50/60 Hz
- Temporizador: 30", 60" e 99"segundos
- Saída do Adaptador: DC 24V/1.5A
- Temperatura de trabalho: -10°C a -35°C
- Base desmontável
- Para manicure e pedicure.

### Lampe UV-led pour ongles modèle: FAST LIGHT Catalisador de unhas UV-led modelo: FAST LIGHT

u.m.vta: 1  8 

REF. 06641

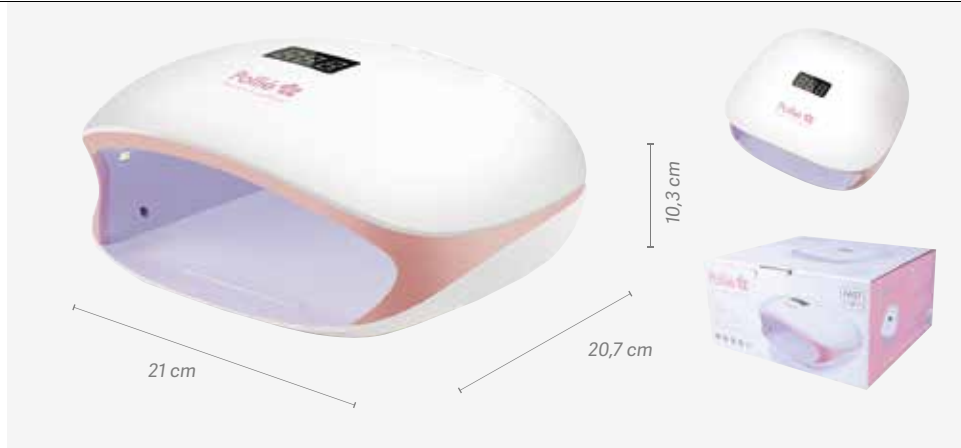

SCAN  
ME!

- Puissance: 48W
- Poids: 740 g
- Ampoule à LED UV: 36 unités
- longueur d'onde des Leds : 395-405nm
- Tension: 100-240 V ~
- Fréquence 50/60 Hz
- Minuterie: 10°,30", 60 "et 99" secondes
- Adaptateur de sortie: DC 24V / 1.5A
- Température de fonctionnement: -10°C à -35°C
- Base amovible

- Potência: 48W
- Peso: 740 g
- Lâmpadas Led/UV: 36 unidades
- Comprimento de onda Leds: 395-405nm
- Voltagem: 100-240V
- Frequência 50/60 Hz
- Temporizador: 10°,30", 60" e 99"segundos
- Saída do Adaptador: DC 24V/1.5A
- Temperatura de trabalho: -10°C a -35°C
- Base desmontável



Nous présentons nos lampes led 24w (réf.04919 star light model) et 48w (réf. 04920 energy light model), elles sont le complément idéal pour le séchage des vernis à ongles semi-permanents et des gels de reconstruction manucure / pédicure, ainsi comme ceux formulés spécialement pour le séchage à LED.

Apresentamos as nossas lâmpadas led de 24W (ref.04919 star light model) e 48w (ref 04920 energy light model), que são o complemento ideal para a secagem da verniz de unhas semi-permanentes e géis de reconstrução de manicura / pedicura, bem como aqueles formulados especialmente para secagem por LED.

### Lampe led UV 24W STAR LIGHT

#### Catalisador led UV 24W STAR LIGHT

STAR Light

u.m.vta: 1  12 

REF. 04919



SCAN ME!





- Puissance: 24W
- Led/UV: 15 unités
- Longueur d'onde des Leds : 395-405nm
- Tension: 100-240V~
- Fréquence 50/60 Hz
- Minuterie: 10", 30", 60" y 99"secondes
- Base amovible pour manucure et pédicure

- Potência: 24W
- Led / UV : 15 unidades
- Comprimento de onda Leds: 395-405nm
- Voltagem: 100-240V ~
- Frequência 50/60 Hz
- Temporizador: 10 ", 30", 60 " and 99" segundos
- Base desmontável para manicure e pedicure.

### Lampe led UV 48W ENERGY LIGHT

#### Catalisador led UV 48W ENERGY LIGHT

ENERGY Light

u.m.vta: 1  12 

REF. 04920



- Puissance: 48W
- Led/UV: 24 unités
- Longueur d'onde des Leds : 395-405nm
- Tension: 100-240V~
- Fréquence 50/60 Hz
- Minuterie: 10", 30", 60" y 99" secondes
- Base amovible pour manucure et pédicure

- Potência: 48W
- Led / UV : 24 unidades
- Comprimento de onda Leds: 395-405nm
- Voltagem: 100-240V ~
- Frequência 50/60 Hz
- Temporizador: 10 ", 30", 60 " and 99" segundos
- Base desmontável para manicure e pedicure.

**Ampoule de rechange · Lâmpada de substituição**9W UV  
9W UV**REF. RE03150/01**9W UV Led  
9W UV Led**REF. RE04354/02****Mini lampe led 2w portable usb**  
**Mini catalisador de unhas led 2w portátil usb**u.m.vta: 1  72 **REF. 04355**

- Puissance: 2W
- Spéciale pour les ongles en gel, vernis semi-permanent
- Lumière UV de 365 nm.
- Minuterie 10 "
- CABLE USB INCLUS
- Idéale pour être emportée en voyage et pour être mise en poche grâce à sa petite taille

- Potência: 2W
- Especial para unhas de gel, verniz semipermanente...
- Luz UV 365 nm.
- Temporizador 10"
- CABO USB INCLUÍDO
- Ideal para levar de viagem e transportar graças ao seu tamanho de bolso.





## Manucure spa Spa manicure



u.m.vta: 1  24

REF. 04265

- Puissance: 2W
  - Batterie non incluse
  - Massage pré-manucure avec bulles stimulant qui adoucit les cuticules
  - Tension: 100-240V~
  - Fréquence 50/60 Hz
- Potência: 2W
  - Bateria não incluída
  - Massagem estimulante de borbulhas pré-manucure que suaviza as cutículas
  - Voltagem: 100-240V ~
  - Frequência 50/60 Hz



## Aspirateur ongles pour manucure Aspirador manicure

u.m.vta: 1  8 

REF. 04205



Aspirateur de table pour la poussière de manucure, design élégant et très fonctionnel, actuel et original. Aspire parfaitement la poussière la poussière est emmagasinée dans un sachet qui se trouve sous l'aspirateur purifie l'air.

- Puissance: 23W
- Batterie non incluse
- Avec 3 sachets de rechange

Aspirador para utilizar sobre a mesa de manicure para aspirar o pó, elegante e muito funcional, design moderno e atual. Aspira eficazmente o pó produzido resultante da limpeza, ou com a broca, o pó vai parar debaixo do aspirador, num saco adequado, evitando assim respirar restos de pó.

- Potência: 23W
- Bateria não incluída
- Com 3 sacos de substituição



**Paraffine: hydrate et nourrit vos mains et vos pieds****Parafina: hidrata e nutre suas mãos e pés**u.m.vta: 1  24 

- Hydrate en profondeur
- Améliore considérablement l'apparence de la peau
- Élastifie la peau
- Améliore la microcirculation sanguine
- Il favorise l'absorption des actifs
- Aide à éliminer les liquides et les toxines
- Améliore les contractures et facilite le massage
- Apaise la douleur et l'inflammation

- Hidrata em profundidade
- Melhora significativamente a aparência da pele
- Elasticiza a pele
- Melhora a microcirculação sanguínea
- Favorece a absorção de ativos
- Ajuda a eliminar líquidos e toxinas
- Melhora as contraturas e facilita a massagem
- Suaviza a dor e a inflamação

**REF. 04671****Monoï paraffine de Tahiti et menthe**

Soin tonifiant réparateur de la peau des mains et des pieds. Le monoï de Tahiti équilibre le manteau hydrolipidique naturel de la peau. Cela le rend plus élastique et offre une Grande capacité à retenir l'humidité. Grâce à l'huile de menthe, elle tonifie et rafraîchit la peau.

*Parafina Monoï do Tahiti e Mint*

Tratamento tonificante restaurador da pele das mãos e pés. O Monoï de Tahiti equilibra o manto hidrolipídico natural da pele. Isso torna mais elástica e fornece uma Grande capacidade de reter a umidade. Graças ao óleo de menta, tonifica e refresca a pele.

**REF. 04672****Paraffine Orange et Pêche**

Traitement nourrissant-protecteur de la peau des mains et des pieds. Riche en caroténoïdes, il possède d'importantes propriétés antioxydantes. C'est un traitement idéal pour les peaux matures et déshydratées.

*Parafina Laranja e Pêssego*

Tratamento nutricional da pele das mãos e pés. Rico em carotenóides, possui importantes propriedades antioxidantes. É um tratamento ideal para peles maduras e desidratadas.

**REF. 04673****Manteiga De Karité De Parafina**

Tratamento antioxidante A manteiga de karité é um dos melhores hidratantes e emolientes por excelência. Proporciona bem-estar e proteção à pele.

*Manteiga De Karité De Parafina*

Tratamento antioxidante A manteiga de karité é um dos melhores hidratantes e emolientes por excelência. Proporciona bem-estar e proteção à pele

**Chauffage numérique de paraffine et avec mémoire de température****Aquecedor de parafina digital e com memória de temperatura**u.m.vta: 1  6 **REF. 06335**

- Puissance: 200W
- Poids: 2 Kg
- Tension: 220-240 V ~
- Fréquence 50/60 Hz
- Température: 40°C - 70°C
- Convient aux pieds et aux mains

- Potência: 48W
- Peso: 2Kg
- Voltagem: 100-240V~
- Frequência 50 Hz
- Temperatura: 40°C a 70°C
- Adequado para pés e mãos



**Sachet contenant 2 gants protecteurs anti uv, anti taches**  
**Pacote 2 luvas protetoras da pele anti-uv, antimanchas**

u.m.vta: 2  200

**REF. 04686**



**Sachet 2 mitaines paraffine**  
**Pacote 2 manfflas de corda paraffin**

u.m.vta: 1  200

**REF. 06615**



Mitaines pour le traitement de la paraffine. Sa doublure intérieure permet de maintenir la température pour un résultat de traitement optimal..

*Luvas para o tratamento de parafina. Seu revestimento interno permite manter a temperatura para um resultado de tratamento ideal.*

**Sachet 2 chaussons paraffine**  
**Pacote 2 peucos rizo parafina**

u.m.vta: 1  200

**REF. 06616**



Chaussons pour le traitement de la paraffine. Sa doublure intérieure permet de maintenir la température pour un résultat de traitement optimal..

*Luvas para o tratamento de parafina. Seu revestimento interno permite manter a temperatura para um resultado de tratamento ideal.*

**Pack 50 sachets en plastique parafin**  
**Pacote 50 parafina sacos plásticos**

u.m.vta: 1  300

**REF. 06617**

Sachets en plastique pour le traitement de la paraffine des mains et des pieds. Ils intensifient la chaleur et l'empêchent de s'évaporer rapidement.

*Sacos de plástico para o tratamento de parafina nas mãos e nos pés. Intensificam o calor e evitam que evapore rapidamente.*



### Ponceuse à ongles professionnel 30.000 Rpm Broca profissional 30,000 rpm

u.m.vta: 1		8
------------	---	---

REF. 06624



Excellente performance pour un travail professionnel. Moteur silencieux et poignée légère permettant de travailler confortablement.



- Puissance : 45 W
- Tension : 220 V
- Poids stylo : 146 g
- Poids de base du moteur: 1250 g

*Broca de excelente desempenho para um trabalho profissional. Motor silencioso e manípulo leve que permite trabalhar confortavelmente.*

- Potência: 45 W
- Voltagem: 110 – 220 V
- Peso manípulo: 146 g
- Peso básico do motor: 1250 g



### Ponceuse à ongles professionnel 30.000 Rpm Broca profissional 30,000 rpm

u.m.vta: 1		12	
------------	---	----	---

REF. 06625

Ponceuse à ongles avec un rapport qualité / prix fabuleux. Silencieux et durable conçu pour le professionnel et l'apprenti.

- Puissance : 30 W
- Tension : 220 V
- Poids stylo : 130 g
- Poids de base du moteur: 730 g

*Bateria não incluída  
Com uma relação preço / qualidade fabulosa.  
Silencioso e durável projetado para o profissional e o aprendiz*

- Potência: 30 W
- Voltagem: 110 – 220 V
- Peso manípulo: 130 g.
- Peso básico do motor: 730 g



Comprend: 6 accessoires + 6 émeris  
Inclui: 6 acessórios + 6 esmeril

## Appareil manucure POCKET

### Broca manucure POCKET

Comprend: 6 accessoires + 6 émeris  
Inclui: 6 acessórios + 6 esmeril

u.m.vta: 1  12

REF. 06695

- Puissant, silencieux et portable
- Design compact, idéal pour voyager
- Très léger
- 10 heures d'autonomie
- Vitesse : 30 000 tr/min
- Puissance : 24 W
- Capacité de la batterie : 2 000 mA (11.1 V)
- Temps de charge de la batterie : 2 heures
- Durée de la batterie à vitesse maximale : 10 heures
- Très silencieux, ne chauffe pas, ne vibre pas
- Poids base : 283 g.
- Poids stylo : 157 g.
- Tension : 110 – 220 V
- Catégorie II 50/60 Hz



- *Potente, silencioso e portátil*
- *Design compacto perfeito para viajar*
- *Muito leve*
- *10 horas de autonomia*
- *Velocidade: 30 000 R.P.M.*
- *Potência: 24 W*
- *Capacidade da bateria: 2000 mA (11.1V)*
- *Tempo de carregamento da bateria: 2 horas*
- *Duração da bateria à velocidade máxima: 10 horas*
- *Muito silencioso, não aquece nem vibra*
- *Peso bateria portátil: 283 g.*
- *Peso manípulo: 157 g.*
- *Voltagem: 110 – 220 V*
- *Classe II 50/60 Hz*



## Appareil manucure QUICK

### Torno manicure QUICK

Comprend: 6 accessoires + 6 émeris  
Inclui: 6 acessórios + 6 esmeril

u.m.vta: 1  8 



REF. 06696

- Puissant et silencieux
- Design compact, idéal pour voyager
- Très léger
- Vitesse : 30 000 tr/min
- Puissance : 24 W
- Très silencieux, ne chauffe pas, ne vibre pas
- Poids base : 341 g.
- Poids stylo : 155 g.
- Tension : 110 – 220 V.
- Catégorie 50/60 Hz.

- *Potente e silencioso*
- *Design compacto perfeito para viajar*
- *Muito leve*
- *Velocidade: 30 000 R.P.M.*
- *Potência: 24W*
- *Muito silencioso, não aquece nem vibra*
- *Peso torno: 341 g.*
- *Peso manípulo: 155 g.*
- *Voltagem: 110 – 220 V.*
- *Classe II 50/60 Hz.*



**Pieces de rechange pour ponceuses**  
**Peças de reposição para brocas**

u.m.vta: 1  12 

- REF. 06779**
- Mandrin adaptateur pour cylindres fraiseurs
  - Mandril adaptador para cilindros esmeriles

- REF. 06780**
- Brosse de polissage
  - Ø 0,65
  - Escova polidora
  - Ø 0,65

- REF. 06781**
- Cône en pierre feutre
  - Ø 0,6
  - Cone de pedra feltro
  - Ø 0,6



- REF. 06782**
- Fraise pierre forme de tonneau
  - Ø 0,6
  - Fresa pedra forma de barril
  - Ø 0,6

- REF. 06783**
- Fraise pierre conique
  - Ø 0,4
  - Fresa pedra cônica
  - Ø 0,4

- REF. 06784**
- Fraise diamant avec pointe ronde
  - Fresa diamante com ponta redonda



- REF. 06785**
- Fraise diamant cylindrique forme
  - Fresa diamante cilíndrica forma



- REF. 06786**
- Fraise diamant cylindrique tonneau
  - Fresa diamante cilíndrica barril

- REF. 06787**
- Fraise diamant cylindrique tonneau
  - Fresa diamante cilíndrica barril





## Pieces de rechange pour ponceuses Peças de reposição para brocas

u.m.vta: 1	 12	
------------	--	---

### REF. 06788

- Fraise diamant cylindrique tonneau
- Fresa diamante cilíndrica barril

### REF. 06789

- Fraise diamant aiguille
- Fresa diamante agulha

### REF. 06790

- Fraise en silicone polissage gain
- Fresa de silicone polidora gão



### REF. 06791

- Fraise en céramique tonneau diamètre
- Ø 0,66
- Fresa de cerâmica barril diâmetro
- Ø 0,66

### REF. 06792

- Fraise céramique tonneau avec pointe arrondie
- Ø 0,66
- Fresa cerâmica barril com ponta redonda
- Ø 0,66

### REF. 06793

- Fraise céramique aiguille diamètre
- Ø 0,23
- Fresa cerâmica agulha diâmetro
- Ø 0,23



### REF. 06794

- Fraise céramique conique diamètre
- Ø 0,6
- Fresa cerâmica cônica diâmetro
- Ø 0,6

### REF. 06795

- Fraise tungstène bleu conique
- Ø 0,6
- Fresa tungstênio azul cônica
- Ø 0,6



**Kit ponceuse à ongle accessoires**  
**Kit acessórios broca**

6 accessoires + 6 émeris  
 6 acessórios + 6 cilindros esmerilidos

u.m.vta: 1  500

**REF. 06626**



**Distributeur de 100 emobuts emeri**  
**Dispensador de 100 cilindros esmerilidos**

u.m.vta: 1  30

**REF. 06627**

- Fin
- Durete: 180
  
- Fino
- Dureza: 180

**REF. 06628**

- Moyen
- Durete: 120
  
- Médio
- Dureza: 120

**REF. 06629**

- Gos gain
- Durete: 80
  
- Gosso
- Dureza: 80



## Ponceuse à ongles électrique PROMED 620

### Broca PROMED 620

u.m.vta: 1 6

REF. 04103



- Puissance: 21W
- Ponceuse à Ongles Electrique à double sens
- La plus petite Ponceuse à Ongles Electrique professionnelle de table sur le marché.
- Adaptée pour le traitement des ongles des mains et des pieds, ainsi que les faux ongles et les ongles en gel ou en acrylique.
- Élimine facilement les callosités et la dureté.
- Petite taille: 110 x 90 x 80 mm.
- Résistante à l'acétone avec moteur refroidi (75g).
- Support d'appui pour la Ponceuse intégré dans la base.
- Comprend différentes fraises et embouts (10 accessoires + 30 émeris)
- Fermeture rapide automatique pour fraises ou embouts standard de 2,25 mm
- Interrupteur avec protection contre la poussière.
- Vitesse réglable en continu jusqu'à 20 000 tr / min.
- Tension: 115-230V~
- Fréquence 50/60 Hz

- Potência: 21W
- Broca duplo sentido de rotação
- A broca profissional de mesa mais pequena do mercado.
- Indicada para o tratamento de unhas das mãos e pés, como para unhas artificiais, de gel ou acrílicas.
- Elimina facilmente calos e durezas.
- Tamanho reduzido: 110 x 90 x 80 mm.
- Resistente à acetona, com motor refrigerado (75g).
- Suporte de apoio da broca integrado na base.
- Inclui diferentes limas e ponteiros (10 acessórios + 30 esmeris)
- Fecho rápido automático para brocas ou ponteiros de 2,25mm
- Interruptor com proteção contra entrada de pó.
- Velocidade contínua regulável até 20,000 r.p.m.
- Voltagem: 115-230V ~
- Frequência 50/60 Hz

## Ponceuse à ongles promed perfect

### PROMED PERFECT broca

u.m.vta: 1 12

REF. 03222

- Puissance: 13 W
- 12.000 tr / min.
- Double sens.
- 10 accessoires + 30 émeris + 1 brosse
- Lumière froide intégrée pour éclairer la zone de travail
- Tension: 220-230V~
- Fréquence 50 Hz

- Potência: 13 W
- 12,000 r.p.m.
- Duplo sentido de rotação.
- 10 acessórios + 30 esmeris + 1 escova
- Luz fria incorporada para iluminar a zona a trabalhar
- Voltagem: 220-230V ~
- Frequência 50 Hz



## Appareil MP815 manucure/pédicure

### Torno MP815 manicure/pedicure

MEDISANA®

u.m.vta: 1  4

REF. 06443

**Soin et traitement des ongles, cuticules et callosités. Lumière led pour plus de précision. Apte pour diabétiques.**

- Accessoires inclus pour le polissage des ongles : 2 rouleaux pour polissage et 2 rouleaux pour brillance
- 7 accessoires de haute qualité pour différentes applications
- Rotation à droite et à gauche, design ergonomique
- Arrêt automatique si la pression est trop forte
- Dimensions : 15 x 3,8 x 3,7 cm
- Poids : 101 g
- Tension : 230V, 50 hz
- Vitesse de rotation : 3 niveaux de 3 500 / 5 000 / 8 000 tr/m
- Longueur du câble : 1,5 m
- Sac de rangement inclus

*Cuidado e tratamento das unhas, cutículas e calosidades. Com luz led para uma aplicação mais precisa e apto para diabéticos.*

- *Acessórios para el polimento das unhas que incluem: 2 rolos de polimento e 2 para dar brilho*
- *Com 7 acessórios de elevada qualidade para diferentes aplicações*
- *Rotação à direita e à esquerda e design ergonómico*
- *Detém-se de forma automática quando a pressão é demasiado alta*
- *Tamanho: 15 x 3,8 x 3,7 cm*
- *Peso: 101 g*
- *Tensão: 230V, 50 hz*
- *Velocidade de rotação: 3 níveis de 3500/5000/8000 rpm*
- *Comprimento do cabo: 1,5 m*
- *Com bolsa de armazenamento.*



## Appareil MP815 manucure/pédicure

### Torno MP815 manicure/pedicure

u.m.vta: 1  4

REF. 06444

**Soin et traitement des ongles, cuticules et callosités. 7 accessoires de haute qualité pour différentes applications. Apte pour diabétiques.**

- Rotation à droite et à gauche, design ergonomique
- Arrêt automatique si la pression est trop forte
- Dimensions : 15 x 3,8 x 3,7 cm
- Poids : 101 g
- Tension : 230V, 50 HZ
- Vitesse de rotation : 2 niveaux de 3 500 / 4 600 tr/m
- Longueur du câble : 1,5 m
- Sac de rangement inclus

*Cuidado e tratamento das unhas, cutículas e calosidades. Torno com 7 acessórios de elevada qualidade para diferentes aplicações. Apto para diabéticos.*

- *Rotação à direita e à esquerda e design ergonómico*
- *Detém-se de forma automática quando a pressão é demasiado alta*
- *Tamanho: 15 x 3,8 x 3,7 cm*
- *Peso: 101 g*
- *Tensão: 230V, 50 hz*
- *Velocidade de rotação: 2 níveis de 3500/4600 rpm*
- *Comprimento do cabo: 1,5 m*
- *Com bolsa de armazenamento*



## Pieces de rechange pour ponceuses

### Peças de reposição para brocas

u.m.vta: 1  10

REF. 06443



REF. 06444

## REF. 02149



- Cône feutre
- Cone feltro

## REF. 02150



- Cône saphir à gain fin
- Cone Safira gão fino

## REF. 02151



- Cône saphir à gros gain
- Cone Safira gão grosso

## REF. 02152



- Disque saphir fin
- Disco Safira gão fino

## REF. 02153



- Fraise à saphir ronde
- Lima safira

## REF. 02154



- Saphir fraise aiguille
- Cortador de agulha

## REF. 02155



- Gos cône de saphir
- Grande cone de safira

## REF. 02156



- Pousse-cuticules
- Espurra cutículas

## REF. 02157



- Fraise saphir cylindrique
- Lima cilíndrica

## REF. 02158



- Gain saphir gossier
- Disco Safira gão gosso

## REF. 02159



- Fraise ovale en saphir
- Lima safira ovalada

## REF. 02164



- Balai de pédicure de soin de pied
- Escova

## REF. 02165



- Adaptateur de fraises
- Adaptador de Limas

## REF. 02160



- Adaptateur avec 30 Tube émeris pour ponceuse électrique
- Adaptador com 30 tubos de esmeris

**Pieces de rechange pour tours**  
**Peças de reposição para brocas**

u.m.vta: 1  10



**REF. 02958**



- Embout de ponceuse
- pédicure saphir
- Esmerilador Cónico Safira

★

**REF. 02959**



- Fraise saphir pointue
- Lima pontiaguda safira

★

**REF. 02960**



- Fraise saphir ronde
- Lima redonda safira

★

**REF. 02961**



- Disque saphir grossier, grain fin
- Cilindro lima safira, refinado

★

**REF. 02962**



- Cône de polissage / filtre
- Cone polidor/ filtro

★

**REF. 02976**



- Mandrin pour émeri
- Adaptador cilindro esmeril

★

**REF. 02980**



- Polisseur moyen en silicone
- Polidor silicone médio

★

**REF. 02981**



- Polisseur épais en silicone
- Polidor silicone grosso

★

**REF. 02982**



- Fraise longue
- Lima larga

★

**REF. 02983**





- Embout de ponceuse
- pédicure, callosités
- Esmerilador pedicure calosidades

★

\* Non stérilisable à pression ou température (autonettoyant, stérilisateur à quartz)  
Désinfectable uniquement avec un désinfectant ou de l'alcool

\* Não esterilizável com pressão ou temperatura (autolavagem, esterilizador de quartzo)  
Desinfetável apenas com desinfetante ou álcool

**Disque saphir gain moyen**  
**Disco safira gão médio**

u.m.vta: 1  12 

**REF. 07237**

- Pour appareil de manucure-pédicure
- Para torno de manicure-pedicure





## Lampe loupe avec Lumière

### Lupa com luz

u.m.vta: 1  4

REF. 03821



- Puissance: 5W
- Lentille 5 dioptries
- Diamètre de la lentille: 10,16 cm
- Éclairage: 48 LEDS
- Couvercle de protection pour lentille, base de loupe pour bureau
- Tension: 220-240V~
- Fréquence 5 Hz

- Potência: 5W
- Lente de 5 dioptrias
- Diâmetro da lente: 10,16 cm
- Iluminação: 48 LEDS
- Tampa protetora para a lente, base da lupa reforçada para maior estabilidade
- Voltagem: 220-240V ~
- Frequência 5 Hz

## Lampe loupe avec lumière

### Lupa com luz

u.m.vta: 1  4

REF. 04948





- Puissance: 6W
- Lentille 5 dioptries
- 60 leds Smd a 6 niveaux de graduation en mode froid et chaud
- 800 lumen
- Maximum de lumière, avec une reproduction très réelle des couleurs, longue durée et très faible consommation
- Indice de rendu des couleurs, 80% reproduisant fidèlement les couleurs
- Ne génère pas de chaleur
- Diamètre loupe de verre 12,7 cm
- Épaisseur du verre de 0,5 à 2,1 cm
- 100-240V ca 50-60hz

- Potência: 6W
- Lente de 5 dioptrias
- 60 leds Smd tem 6 níveis de graduação em modo frio e quente
- 800 lumen
- Luz máxima, com reprodução muito real das cores, longa duração e consumo muito baixo
- Índice de reprodução de cor, é de 80% reproduzindo as cores fielmente
- Não gera calor
- Lupa de vidro de diâmetro 12,7 cm
- Espessura de vidro de 0,5 a 2,1 cm
- 100-240V CA 50-60hz

## Lampe loupe avec lumière

### Lupa com luz

u.m.vta: 1  10 

REF. 04624

- Lampe de table manucure avec pied et clip.
- Lentille 5 dioptries
- Taille de lentille : 100 mm
- Éclairage: 30 LED SMD
- Tension: 100-240V
- Fréquence: 50/60 Hz
- Puissance maximale: 6 w
- Bras du type col de cygne pour support loupe
- Pince de table antidérapante incluse
- Utilisation en intérieur
- 560 lumen pour un usage professionnel.

REF. 04947

- Lâmpada para mesa de manicure com base
- Lente de 5 dioptrias
- Tamanho da lente: 100 mm
- Iluminação: 30 led smd
- Voltagem: 100-240V
- Frequência: 50/60 Hz
- Potência máxima: 6 w
- Braço para suporte da lupa
- Clip antiderrapante incluído para mesa
- Utilizar em interiores
- 560 lumen para uso profissional



Avec accessoire supplémentaire pour la table d'accrochage  
Com acessório extra para mesa

## Lampe- loupe avec lumière led Lupa com luz led

u.m.vta: 1  4

3 dioptries  
3 dioptrias  
**REF. 03815**

5 dioptries  
5 dioptrias  
**REF. 03816**

8 dioptries  
8 dioptrias  
**REF. 03817**

- Puissance: 22W
- Taille de la lentille : 12,7 cm.
- Capuchon de protection pour lentille
- Bras articulé pour support de loupe.
- Mâchoire incluse pour le bureau

- Potência: 22W
- Tamanho da lente: 12,7 cm.
- Tampa protetora para a lente.
- Braço articulado para suporte da lupa.
- Incluído para fixar à mesa.



## Lampe- loupe led smd Lupa com led smd

u.m.vta: 1  1

3 dioptries  
3 dioptrias  
**REF. 04107**

5 dioptries  
5 dioptrias  
**REF. 04108**

8 dioptries  
8 dioptrias  
**REF. 04109**

- Puissance: 22W
- Taille de la lentille : 12,7 cm.
- 60 Leds smd et 570 lumens.
- Lumière maximale, avec une reproduction très réelle decouleurs, longue durée et très faible consommation 6W.
- Elle ne génère pas de chaleur.

- Potência: 22W
- Tamanho da lente: 12,7 cm.
- 60 Leds smd e 570 lumens.
- Máxima luz, com reprodução muito real das cores
- Longa duração e baixo consumo 6W.
- Não aquece.



## Pieds de lampe Base para a lupa

**REF. 03820**



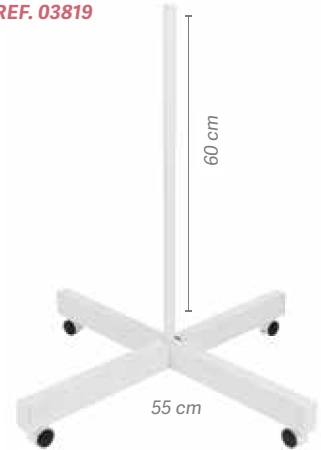

**REF. 03819**



**REF. 04110**



\* Compatible aux références  
03815, 04107, 04198 y 04109  
\* Adaptável a referências  
03815, 04107, 04198 y 04109

**Sachet de limes: droites****Pacote limas: reta**u.m.vta: 12  192 Poids: 10 g.  
Peso: 10 gGossier 0,6 cm  
Gosso 0,6 cm

80/100

150/180

REF.06697

REF.06698

100/180

180/240



REF.06010

REF.06699

**Sachet de limes: courbée****Pacote limas: curvada**

Gossier 0,6 cm

Gosso 0,6 cm

u.m.vta: 12  192 

80/100

150/180

REF.06700

REF.06701

100/180

180/240

REF.06011



REF.06702



**Sachet de limes: polissage**  
**Pacote limas: meia-lua**

Gossier 0,6 cm  
 Gosso 0,6 cm

Poids: 10 g.  
 Peso: 10 g

u.m.vta: 12  192 

80/100

REF.06703

150/180

REF.06704

100/180

REF.06012

180/240

REF.06705



**Sachet de limes: rocket**  
**Pacote limas: rocket**

Gossier 0,6 cm  
 Gosso 0,6 cm

u.m.vta: 12  192 

100/180

REF.06013



**Sachet de limes: la forme carré**  
**Pacote limas: quadrada**

Gossier 0,6 cm  
 Gosso 0,6 cm



u.m.vta: 12  192 

100/180

REF.06014



**Manche métallique pour lime**  
**Cabo metálico para lima**

u.m.vta: 1  12 



**REF.07222** **Droite**  
**Reta**

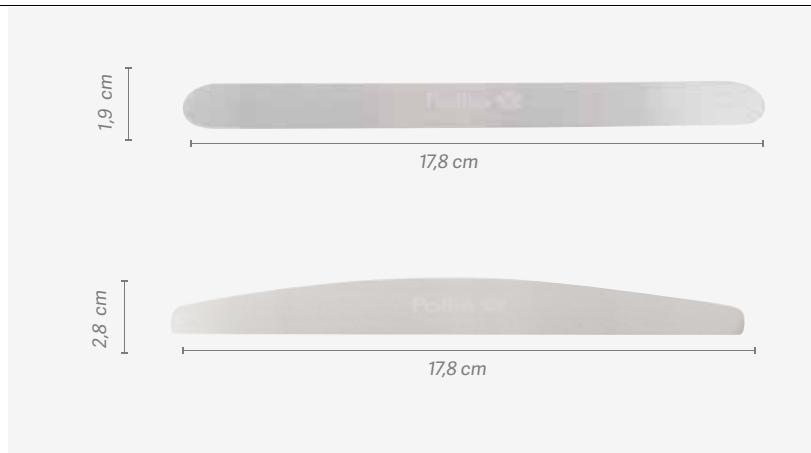

**REF.07223** **Polissage**  
**Meia-lua**



**Pack 48 pièces de rechange lime noir**  
**Pack 48 recargas lima preto**



u.m.vta: 1  12 

**Droite** **Polissage**  
**Reta** **Meia-lua**

**REF.07224** **REF.07225**







**Pack 48 pièces de rechange lime Blanc**  
**Pack 48 recargas lima Branco**

u.m.vta: 1  12 

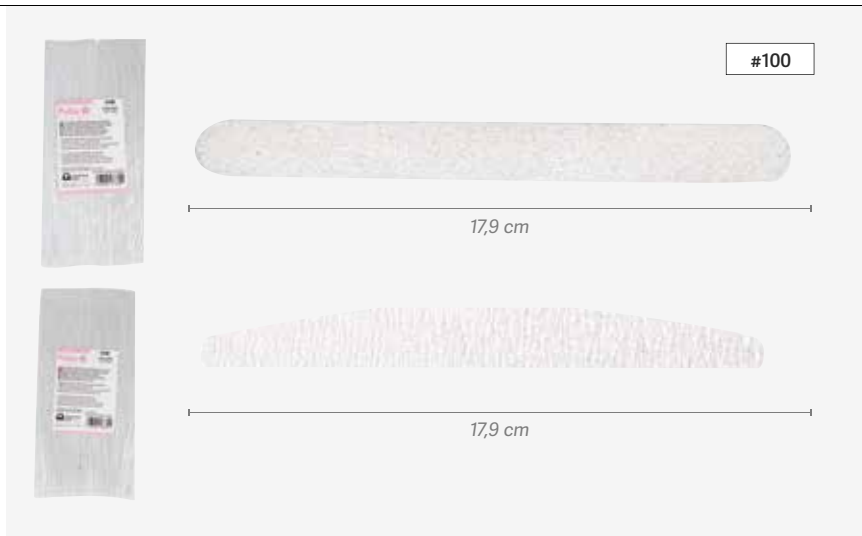
**Droite** **Polissage**  
**Reta** **Meia-lua**

**REF.07228** **REF.07229**

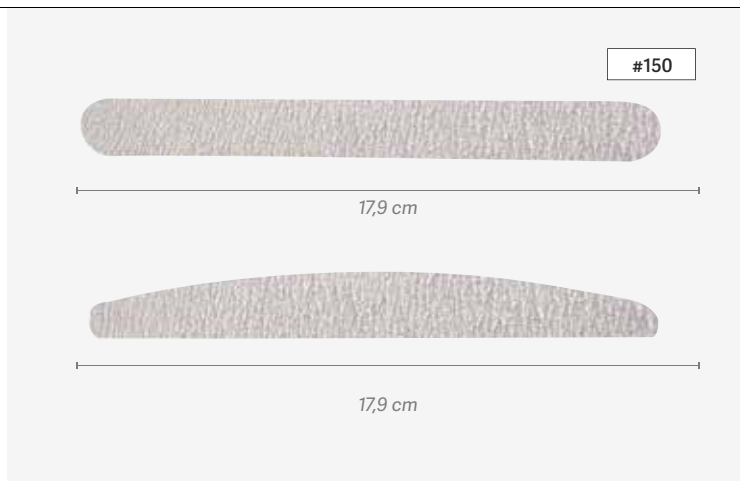

**Pack 48 pièces de rechange lime ZÈBRE****Pack 48 recargas lima ZEBRA**u.m.vta: 1  12 **Droite**  
**Reta****REF.07226****Polissage**  
**Meia-lua****REF.07227****Lime 12 unités****Lima 12 unidades**u.m.vta: 1  40 

80/80

**REF.06020**

100/100

**REF.06021**

180/180

**REF.06022**

240/240

**REF.06023**



400/400

**REF.06024**







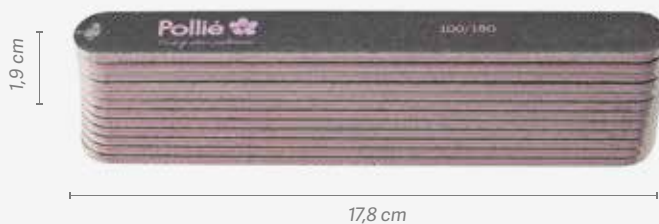

600/600

**REF.06025****Droite**  
**Reta**Choisissez le gammage qui vous convient le mieux  
Escolha a gamagem que melhor se adequa a você





**Lime 12 unités****Lima 12 unidades**u.m.vta: 1  40 **REF.06000****Droite**  
**Reta**

100/180

u.m.vta: 1  40 **REF.06001****Courbée**  
**Curvada**u.m.vta: 1  32 **REF.06002****Polissage**  
**Meia-lua**u.m.vta: 1  28 **REF.06003****Rocket**  
**Rocket**u.m.vta: 1  32 **REF.06004****La forme carrée**  
**Quadrada**

**Sachet de limes zébrées**  
**Pacote limas zebra**

u.m.vta: 12  192 

**REF.06015** **Droite**  
**Reta**



**REF.06016** **Courbée**  
**Curvada**



**REF.06017** **Polissage**  
**Meia-lua**



**REF.06018** **Rocket**  
**Rocket**





**REF.06019** **La forme carrée**  
**Quadrada**



**Lime 12 unités zébrasse**  
**Lima 12 unidades zebra**



Gossier 0,6 cm  
 Gosso 0,6 cm

u.m.vta: 1  40 

**REF.06005** **Droite**  
**Reta**



100/180



u.m.vta: 1  40 



**REF.06006** **Courbée**  
**Curvada**



u.m.vta: 1  32 



**REF.06007** **Polissage**  
**Meia-lua**



u.m.vta: 1  28 

**REF.06008** **Rocket**  
**Rocket**



u.m.vta: 1  32 

**REF.06009** **La forme carrée**  
**Quadrada**





**Lime noire rembourrée**  
**Lima cor preto acolchoada**

Gossier 0,3 cm  
Gosso 0,3 cm

u.m.vta: 12 300

100/180

**REF.03427**

**Droite**  
**Reta**



**REF.03428**

**Courbée**  
**Curvada**



u.m.vta: 12 384

**REF.03429**

**La forme carrée**  
**Quadrada**



**Lime professionnelle zèbre, matelassée 12 unités**  
**Lima profissional zebra acolchoada 12 unidades**

Gossier 0,3 cm  
Gosso 0,3 cm

u.m.vta: 12 480

**REF.03425**

**Droite**  
**Reta**



u.m.vta: 12 300

**REF.03424**

**Courbée**  
**Curvada**



u.m.vta: 12 300

**REF.03426**

**La forme carrée**  
**Quadrada**



100/180 Lavable et désinfectable. Abrasive complet et usage professionnel. Gan durabilité. Recommandé pour ongles en gel et en acrylique.

100/180 Lavável e desinfetável. Sistema abrasivo completo e profissional. Durabilidade extra Lima 2 vezes mais rápido que as limas. Excelente para unhas de gel e acrílico

**Pack 12 lime rem bourré**  
**Pacote 12 lima acolchoada**

Gossier 0,8 cm  
Gosso 0,8 cm

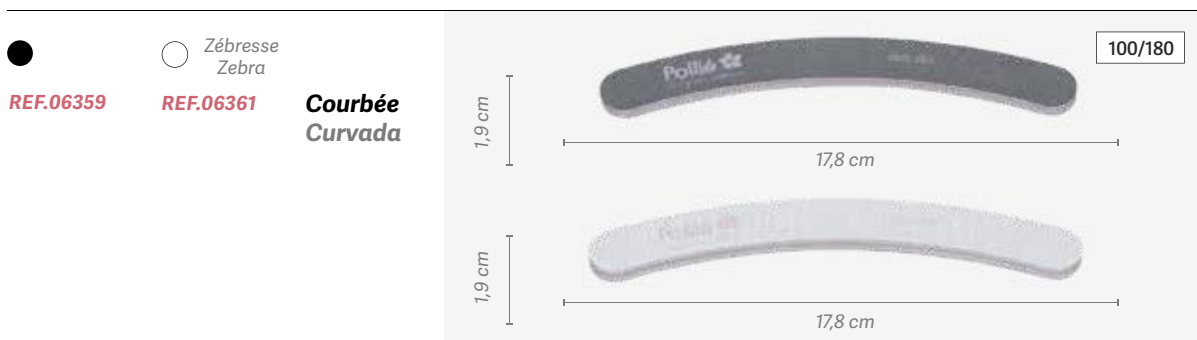
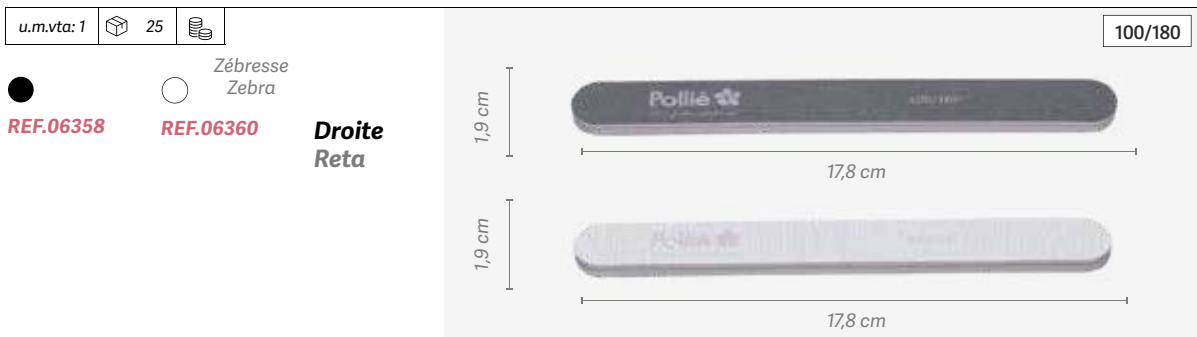

**Paquet de 50 limes américaine. Usage professionnel**  
**Pacote de 50 limas americano. Uso profissional**

Gossier 0,13 cm  
Gosso 0,13 cm

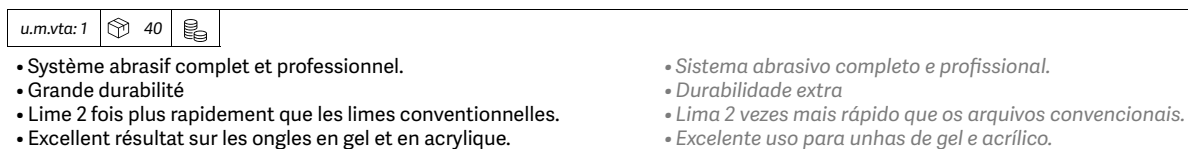

**Lime américaine noire**  
**Lima americana cor preto**

Gossier 0,13 cm  
Gosso 0,13 cm

u.m.vta: 10  1500



100/180

REF.01027



**Pack 12 lime épaisse noire**  
**Pacote 12 lima gossa preto**

Gossier 0,3 cm  
Gosso 0,3 cm

u.m.vta: 1  40 

100/180

REF.01030



REF.01421

**Sachet de limes**  
**Pacote limas**

Gossier 0,4 cm  
Gosso 0,4 cm

u.m.vta: 12  600



100/180

REF.01200



**Pack 12 lime usage professionnelle. Motif zèbre. Rembourrée**  
**Pacote 12 lima profissional zebra acolchoada**

Gossier 0,3 cm  
Gosso 0,3 cm

u.m.vta: 1  40 

100/180

REF.03731

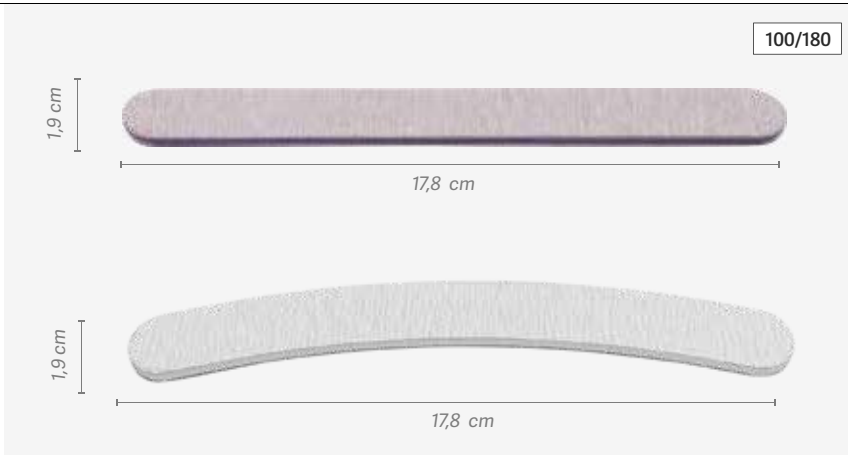



REF.03730



**Sachet de 10 lime en carton****Pacote 10 limas cartão**

Gossier 0,12 cm

Gosso 0,12 cm

u.m.vta: 12  336**REF.00601**u.m.vta: 12  204**REF.00602****Sachet de 6 lime en carton****Pacote 6 limas cartão**u.m.vta: 12  756**REF.01107**

Gossier 0,3 cm

Gosso 0,3 cm

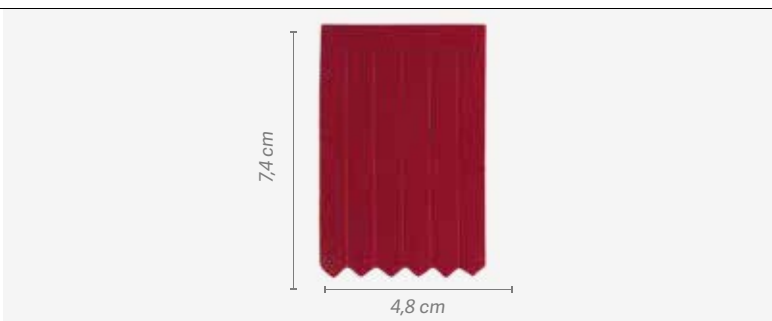
**Kit de de 20 limes R.601-602 (10 + 10)****Pacote 20 limas R.601-602 (10 + 10)**

Gossier 0,12 cm

Gosso 0,12 cm

u.m.vta: 12  120**REF.00621****Sachet de 5 limes américaines rouges****Pacote 5 limas americanas vermelhas**

Gossier 0,12 cm

Gosso 0,12 cm

u.m.vta: 12  216**REF.01517****Paquet de 10 Grandes limes****Pacote 6 limas**

Gossier 0,12 cm

Gosso 0,12 cm



u.m.vta: 12  336**REF.01116**

- Petites
- Pequena



**Poche 5 limes couleurs variées**  
**Pacote 5 limas cores variadas**

Gossier 0,6 cm  
 Gosso 0,6 cm

u.m.vta: 12  60 



180

- Une face pailletée, l'autre gammage 180
- Uma face purpurina e a outra gamagem 180

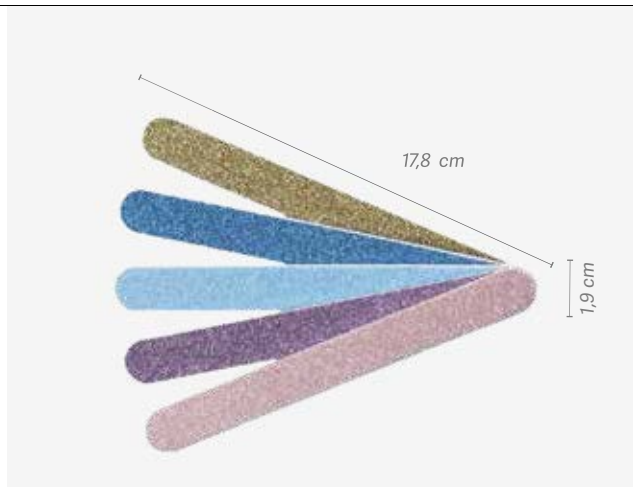
REF.06367



**Sachet 5 limes motif animaux**  
**Pacote 5 limas estampados animais**



u.m.vta: 12  60 

180/240

- Motif animaux
- Estampados animais

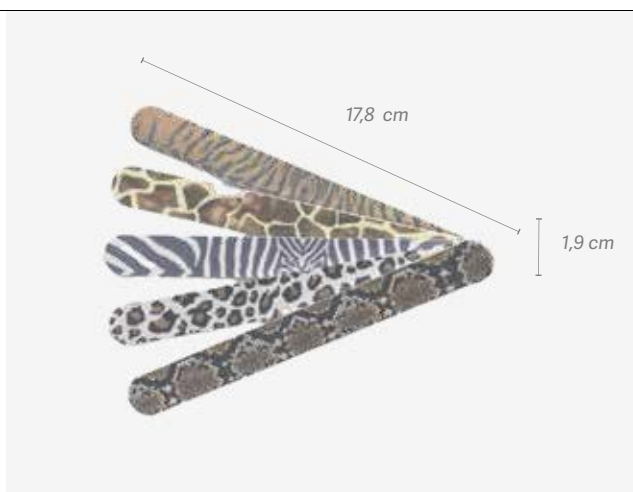
REF.06365



u.m.vta: 12  60 

180/240

- Motif variées
- Estampados variadas

REF.06366

Gossier 0,6 cm  
 Gosso 0,6 cm

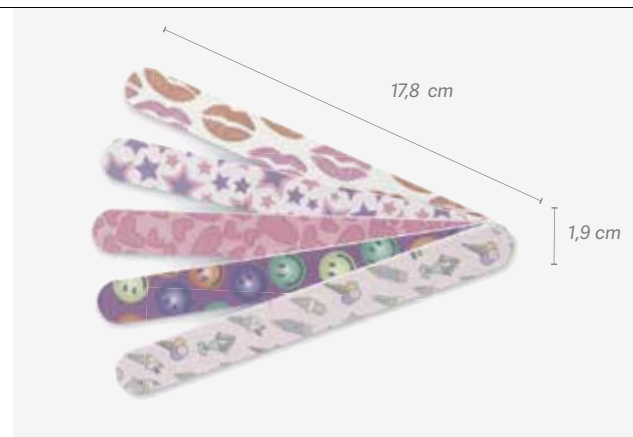

**Manucure parfaite**  
**EN COULEUR**

**Manicures perfeitos**  
**COM COR**

### Présentoir de 42 limes Expositor de 42 limas

u.m.vta: 1  20 

180



REF.06416

- 6 modèles x 7 unités
- Une face pailletée, l'autre abrasive gain 180
- Couleurs assorties
- 6 modelos x 7 unidades
- Uma face purpurina e a outra lima de gamagem 180
- Cores variadas

17,8 x 1,9 x 0,6 cm



### Présentoir de 48 limes Expositor de 48 limas

u.m.vta: 1  20 

180/240

REF.06415

- 6 modèles x 8 unités chacun.
- Motif animaux
- 6 modelos x 8 unidades de cada.
- Estampados animais

17,8 x 1,9 x 0,6 cm



### Présentoir de 48 limes imprimés Expositor de 48 limas estampadas

u.m.vta: 1  20 

180/240

REF.06414

- 6 modèles x 8 unités chacun
- Motif variées
- 6 modelos x 8 unidades.
- Estampados variadas

17,8 x 1,9 x 0,6 cm



### Lime polir les ongles luminosité Lima polidora unhas brilho

Gossier 0,3 cm  
Gosso 0,3 cm

u.m.vta: 12  360



**REF.01029**

- 4 utilisations
- 4 usos



### Fichiers tampons à 3 faces Arquivos de buffer de 3 lados

3 utilisations  
3 usos

u.m.vta: 12  240 

**REF.06363**



**Poids:**

- Partie rose : 320
- Partie blanche : 600
- Partie grise : 4000

**Pesos:**

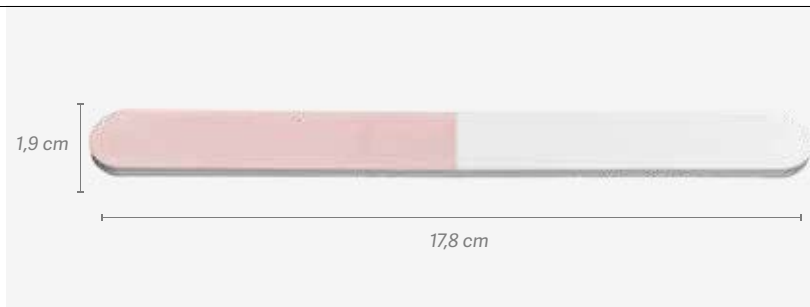
- Parte rosa: 320
- Parte branca: 600
- Parte cinza: 4000



u.m.vta: 12  84 

**REF.06362**

**Poids:**



- Partie rose : 320
- Partie blanche : 600
- Partie grise : 4000

**Pesos:**

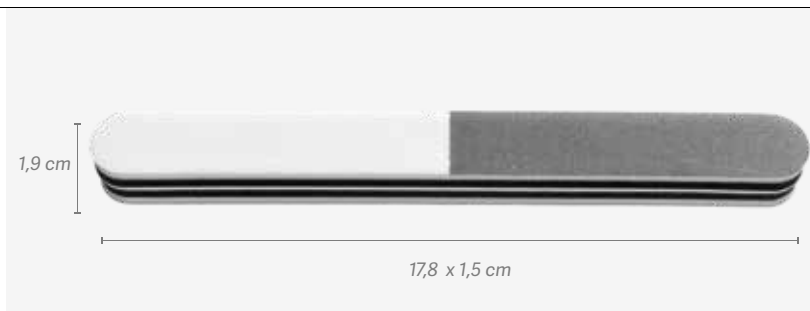
- Parte rosa: 320
- Parte branca: 600
- Parte cinza: 4000



### Lime de polissage demi-lune avec étui Lima polidora meia lua com bolsa

u.m.vta: 12  60 

**REF.06706**

100/180



### Lime rouge rocket avec étui Lima vermelha rocket com bolsa

u.m.vta: 12  144 

**REF.06712**

80/80



### Lime polissage rectangulaire Lima retangular polir



u.m.vta: 12  120

REF.01380



### Bloc 4 Faces

#### Lima bloco 4 faces

u.m.vta: 12  216 



240/320/400/4000

REF.06029



### 20 limes bloc 4 Faces

#### 20 limas bloco 4 faces

u.m.vta: 1  46 

- Lilas
- Lilás

- Orange
- laranja

80/80/100

100/100/180

REF.06030

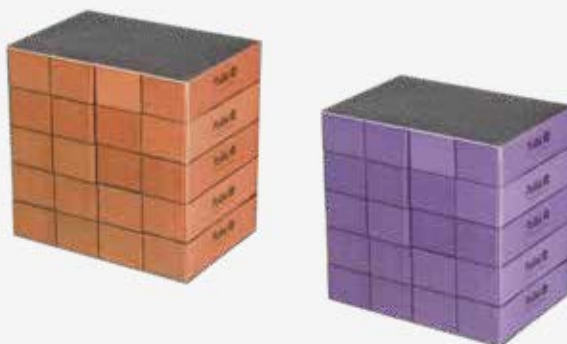

REF.06031

u.m.vta: 1  56 

120

REF.06032

- Blanc
- Branca

u.m.vta: 12  216 

120

REF.06028

- Blanc
- Branca



### Boîte de 50 blocs mini à Caixa de 50 mini blocos

u.m.vta: 1

120



120/120

REF.06708

La lime idéale pour égaliser les Grandes surfaces,  
que ce soit sur des ongles naturels ou artificiels.

A lima ideal para igualar as Grandes superficies,  
seja sobre unhas naturais ou postças.

- 2 faces
- couleur blanc

- 2 faces
- cor branca



### Sachet de 6 blocs mini Pacote de 6 mini blocos

u.m.vta: 12

192



120/120

REF.06707

- 2 faces
- couleur blanc

- 2 faces
- cor branca



### Limes ongles em verre Limas de cristal

u.m.vta: 1

12



Lilas  
Lilás

REF.06630/68

Rosa  
Rose

REF.06630/70

- 2 côtes
- 2 lados

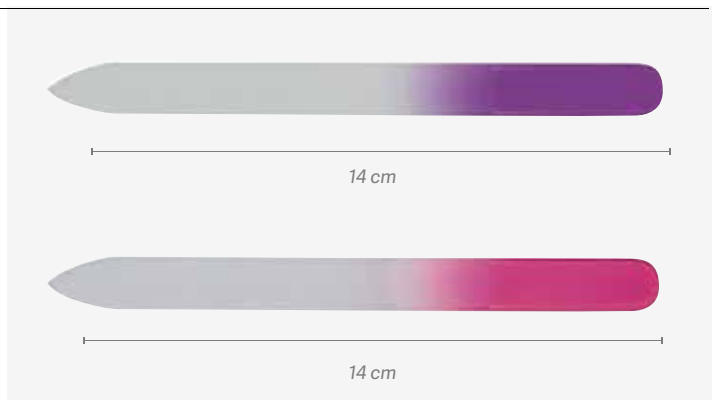



## Lime à ongles Saphire avec manche

### Lima Saphire com punho

u.m.vta: 12  300

REF.00841

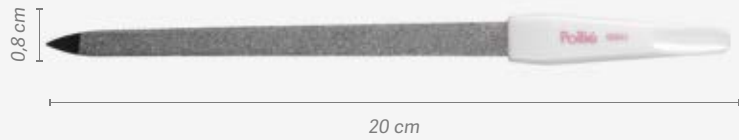

REF.00842

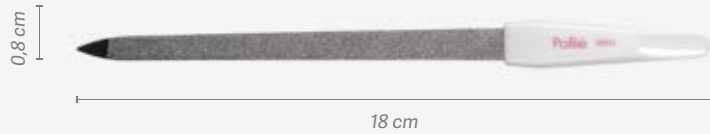

REF.00843



REF.00844



REF.00845



## Coussin repose-main blanc

### Almofada apoia mãos branca

u.m.vta: 1  50

REF.04969

- Pour que les séances de manucure soient plus confortables aussi bien pour le client que pour l'esthéticienne
- Para que a manicure seja mais cómoda, tanto para o cliente como para a esteticista.



### Stérilisateur chaleur sèche *sanity security* Esterilizador calor seco *sanity security*

u.m.vta: 1  1

REF. 03011

- Puissance: 400W
- 20°C - 200°C
- Tension: 220-240V~
- Fréquence 50 Hz
- Température réglable de 20 à 200°

- Potência: 400W
- 20°C - 200°C
- Voltagem: 220-240V ~
- Frequência 50 Hz
- Temperatura ajustável de 20 a 200°



### Stérilisateur germicide GX4 Esterilizador germicida GX4

u.m.vta: 1  1

REF. 03009/59

- Puissance: 15W
- Ultra plat
- Lumière germicide de haute qualité

- Potência: 15W
- Ultra plano.
- Luz germicida elevada qualidade

u.m.vta: 1  20

REF. RE00891/01

Ampoule de rechange  
Lâmpada de substituição

### Stérilisateur GX7 orange Esterilizador GX7 laranja

u.m.vta: 1  1

REF. 03010/64

- Puissance: 75W
- Capacité 120 cc
- Billes de quartz
- Tension: 220-240V~
- Fréquence 50 Hz

- Potência: 75W
- Capacidade 120 cc
- Com esferas de quartzo
- Voltagem: 220-240V ~
- Frequência 50 Hz

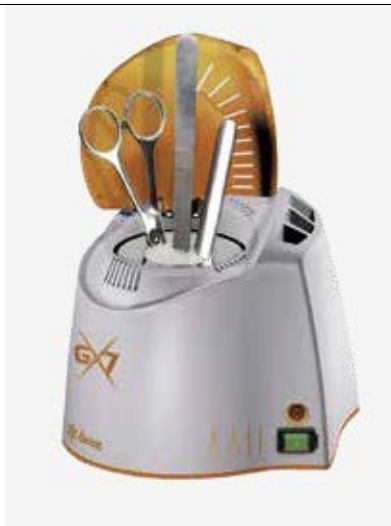



### Pièces de rechange Recargas

- Sachet de rechange de balles de quartz
- 50/60 balles par sachet
- poids 160g environ
- Saco com recargas de esferas de quartzo.
- 50/60 bolas por saco
- Peso 160g aprox

REF. RE03010/64/01

### Pot de quartz sphères 500 g Caixa de esferas de quartzo 500 g



u.m.vta: 1  6 

**REF. 07013**

- Quartz
- Idéal pour les ustensiles tels les ciseaux
- Comprend un sac de sphères
- Ne convient pas aux matières plastiques

- Quartzo
- Ideal para utensílios como tesouras
- Inclui um saco de esferas
- Não é adequado para materiais plásticos

### Pot de quartz sphères Esferas de quartzo

u.m.vta: 1  12 

500 g



**REF. 06619**

Stériliser des outils métalliques  
pour la coiffure et l'esthétique

*Esterilizar ferramentas metálicas  
para cabeleireiro e estética*



### Stérilisateur UV eurostil en plastique esterilizador de plástico UV EUROSTIL

u.m.vta: 1  1 

**REF. 06618**

Stérilisateur à rayons ultraviolets pour tout  
type d'outils aussi bien de coiffure que  
d'esthétique

- Puissance: 8W

*Esterilizador de raios ultravioleta para  
todo o tipo de ferramentas tanto de  
cabeleireiro como de estética*

- Potência: 8W





u.m.vta: 1  1

**REF. RE06618/01**



Ampoule de recharge  
Lâmpada de substituição

### Pinces coupe-cuticules Alicates corta cutículas

u.m.vta: 1  10 

Double ressort tournant et bec de 5,5 mm  
Encaixe mola boca 5,5 mm

**REF. 04659**



La gamme de produits PREMIUM de Pollié est conçue et fabriquée pour répondre au mieux à vos besoins. Fabriquée avec de l'acier inoxydable. Pollié Premium offre la meilleure qualité et performance dans ses nouvelles pinces à ongles et cuticules, les dernières étapes de leurs fabrications sont faites à la main pour obtenir la pince parfaite

A gama de produtos PREMIUM de Pollié está concebida e fabricada para satisfazer ao máximo as suas necessidades. Fabricados com aço inoxidável. Pollié Premium oferece a melhor qualidade e rendimento nos seus novos alicates para unhas e cutículas, os últimos passos da sua fabricação são feitos à mão para conseguir o alicate perfeito.

Double ressort tournant et bec de 4,5 mm  
Encaixe mola boca 5,5 mm

**REF. 04660**





Double tournant et bec de 5,5 mm  
Encaixe mola boca 5,5 mm

**REF. 04661**



### Pince coupé-ongles Alicate corta-unhas

u.m.vta: 1  50 

Coupe simple  
Encaixe simples

**REF. 04663**



**Pince coupe cuticules bleu titane**  
**Alicate cortacutícula titânio**

u.m.vta: 1  12

**REF.03243**



10 cm

**REF.03244**



10 cm

**REF.04697**



11 cm

**REF.03245**



12 cm

**Pince coupe cuticules**  
**Alicate cortacutícula**

u.m.vta: 1  12

Avec fermeture  
 Com fecho

**REF.01275**



11 cm

**Pince coupe cuticules**  
**Alicate cortacutícula**

u.m.vta: 1  12

Bec de 5mm  
Boca 5mm

**REF.02125**



8 cm

Ajustée  
Encaixado

**REF.04692**



10 cm

**REF.01272**



10 cm

**REF.03688**



11 cm



**Pince à cuticules**

**Alicate cutícula**

u.m.vta: 1  1

Acier au carbone  
Aço de carbono

**REF.02264**

Ressort recharge +  
vis pour pince  
Recarga mola +  
parafusos

**REF.02404**

Extra-fine  
Extrafino

**REF.02679**

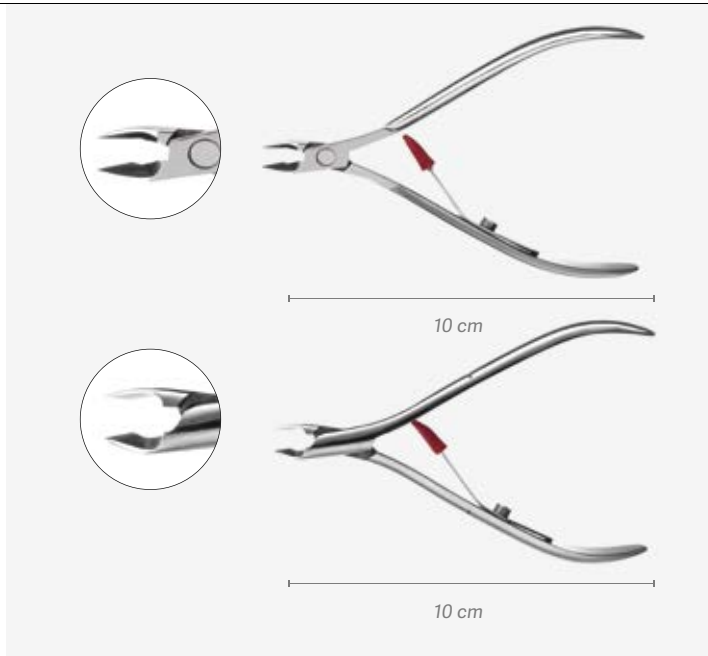

u.m.vta: 1  12

Manche satiné  
Cabo acetinado

**REF.02812**

De forme ronde. Bec 3 mm  
Redondo. Boca 3 mm

**REF.03018**

De forme ronde. Bec 5 mm  
Redondo. Boca 5 mm

**REF.03019**

Bec 4 mm  
Boca 4 mm

**REF.03039**

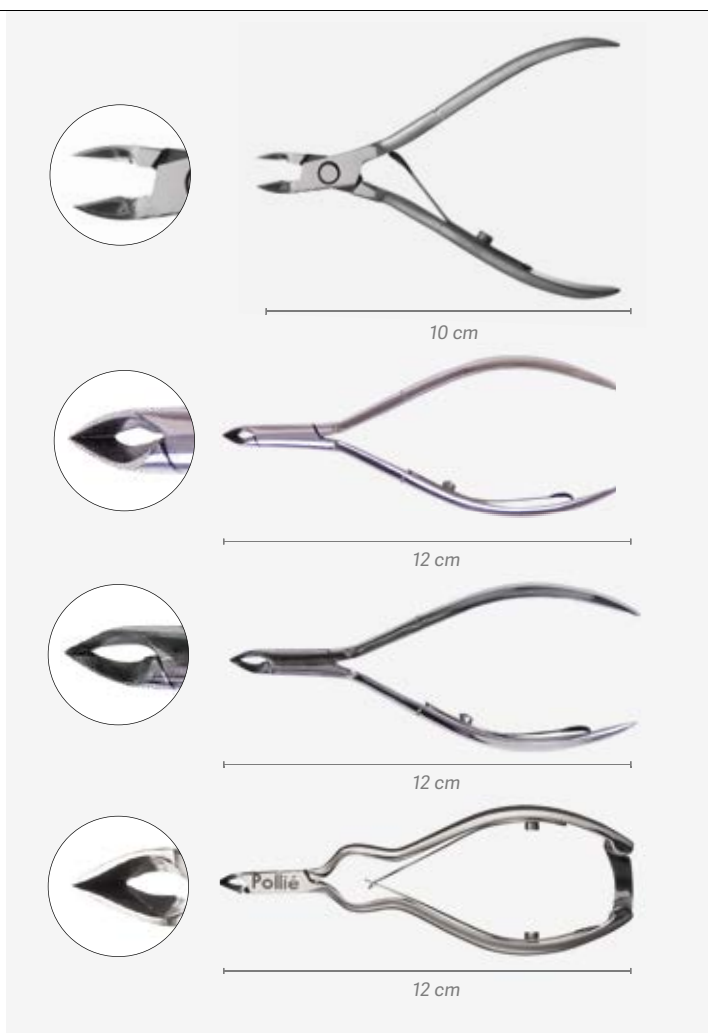

**Pince coupe cuticules En acier chirurgical**  
**Alicate cortacutícula Aço surgical**

u.m.vta: 1  1

**REF.02265**      Bec 2 mm intégré  
 Boca 2 mm

**REF.02266**

Bec de 4 mm intégré  
 Boca 4 mm encaixada

**REF.02267**

Bec de 6 mm intégré  
 Boca 6 mm encaixada

**REF.02405**

Ressort double de rechange + vis pour  
 pince 02265 - 02266 - 02267  
 Recarga mola + parafusos para alicate  
 02265 - 02266 - 02267

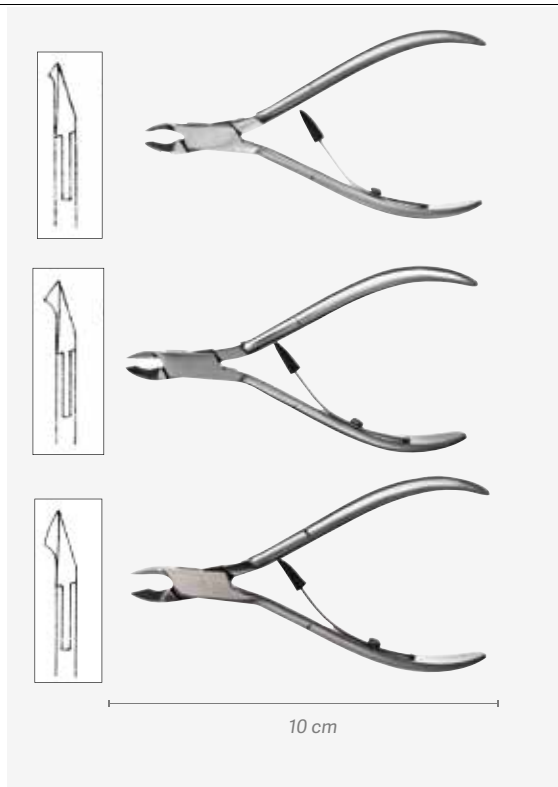

**Pince coupe cuticules Acier inoxydable**  
**Alicate cortacutícula Aço inoxidável**

u.m.vta: 1  12

Bec 3 mm  
 Boca 3 mm

**REF.03685**

Bec 4 mm  
 Boca 4 mm

**REF.03686**

Bec 5 mm  
 Boca 5 mm

**REF.03687**

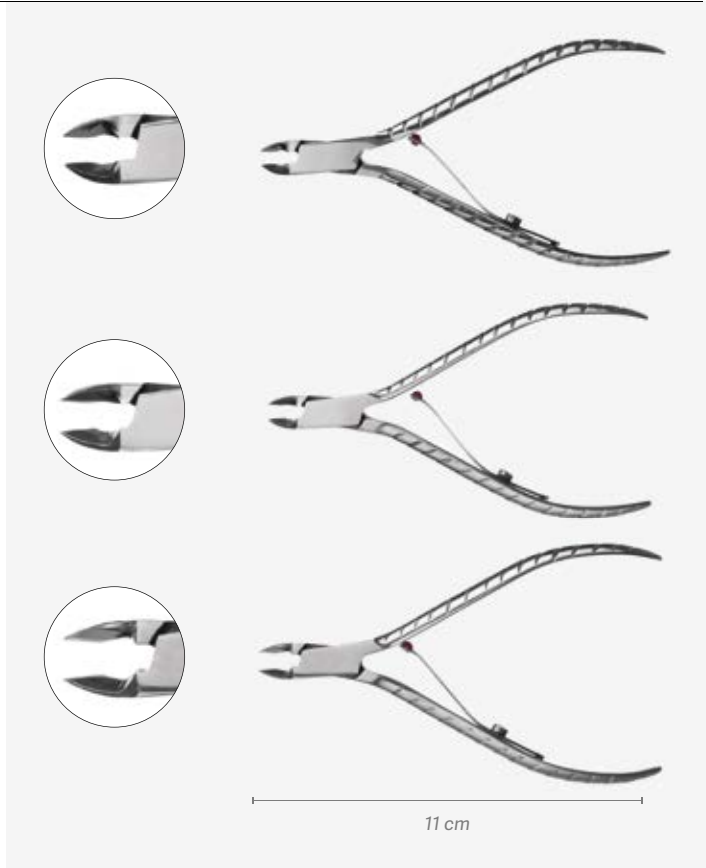

## Pince coupe-ongles

### Alicate corta-unhas

u.m.vta: 1  12

**REF.01271** Acier inoxydable  
Aço inoxidável



10 cm

**REF.02813** Satinée  
Mate



10 cm

**REF.04693**



11 cm

**REF. 01276** Satinée  
Mate



12 cm

**REF.03240** Bleu titane  
Azul titânio



10 cm

**REF.04696** Vec ressort à l'intérieur  
Bleu titane  
Com mola interior  
Azul titânio



11 cm

## Pince coupe cuticules Alicate cortacutícula

u.m.vta: 12	 12
-------------	--

**Blanc**

*Branco*

**REF.01069**



**Blanc avec limes**

*Branco com lima*

**REF.02836**



**REF.01336**



**Lilas avec caoutchouc**

*Lilás com borracha*

**REF.04411**



**Couleurs assorties et en caoutchouc**

*Diferentes cores*

**REF.01037**



**Lilas avec caoutchouc**

*Lilás com borracha*

**REF.04589**



### Coupe-ongles Corta-unhas

u.m.vta: 12  12

- Petit
- Pequeno

REF.01064



- Grand
- Grande

REF.01038



### Coupe-ongles avec réservoir Corta-unhas com depósito

u.m.vta: 12  120

- Petit
- Pequeno

REF.04408



- Grand
- Grande

REF.04407



### Coupe-ongles artificiels Corta-unhas artificial

u.m.vta: 1  12

REF.01476



### Set de manucure complet de 6 pièces Kit de manicure 6 peças completo

u.m.vta: 1  1

REF.02746



### Étui 11 ustensiles manucure Estojo 11 utensílios manicure

u.m.vta: 1  1

REF.04882

- Capacité pour 20 ustensiles
- Capacidade para 20 utensílios



**Étui pour pinces à peaux et coupe-ongles**  
**Capa alicates peles e corta-unhas**

u.m.vta: 1  10

**REF.02402**

- Petit
- Pequeno



u.m.vta: 1  10

**REF.02403**

- Grand
- Grande



**Étui noir pour pinces et coupe ongles**  
**Capa alicates e corta-unhas, cor preto**

u.m.vta: 1  10

**REF.02512**



- Acier stérilisable
- Aço esterilizável

**Étui pour pinces à épiler, petites limes à ongles et ciseaux de manucure**  
**Capa pinças, limas pequenas e tesouras manicure**

u.m.vta: 1  10

**REF.02401**



**Porte-gouge**  
**Suporte de goiva**

u.m.vta: 1  48

**REF.02820**



**12 gouges sous blister individuel**  
**12 goivas em blister individual**

u.m.vta: 1  10

N°1  
**REF.02821**



N°2  
**REF.02822**



N°3  
**REF.02823**



N°4  
**REF.02824**



N°5  
**REF.02825**



N°6  
**REF.02826**



N°8  
**REF.02827**



N°10  
**REF.02828**



N°12  
**REF.02829**





## Comment préparer ses ongles avant de mettre du vernis ? Como preparar a unha para o verniz?

- Toujours stériliser les outils de manucure qui seront utilisés
  - Limer et façonner l'ongle, au goût du client et les assortir.
  - Humidifiez l'ongle avec de l'eau
  - Poussez les cuticules avec un pousoir ou un Bâton d'orange
  - Enlever les peaux avec des pinces spéciales pour les peaux de manucure
  - Passez une lime à polir pour laisser l'ongle sans gaisse et sans brillance
  - Humidifiez à nouveau l'ongle et séchez-le
- Esterilizar sempre as ferramentas de manicure que se vão utilizar.  
• Limar e dar forma à unha, ao gosto do cliente e acertá-las.  
• Humedecer a unha com água.  
• Empurrar as cutículas cm um empurrador.  
• Retirar as peles com um alicate especial para peles de manicure.  
• Passar uma lima para deixar a unha sem brilho.  
• Humedecer a unha de novo e secá-la.



### Pousoir pour cuticules à double fonction en acier inoxydable Empurrador de cutículas duplo em aço inoxidável

u.m.vta: 1  12

REF.04104



u.m.vta: 1  24

REF.04688

u.m.vta: 1  24

REF.04689

### Pousoir pour cuticules en acier inoxydable Empurrador cutículas aço inoxidável

u.m.vta: 1  24



REF.04687



u.m.vta: 1  12

REF.04105

**Brosse à ongles**  
**Escova lima unhas**

u.m.vta: 1  12 



Rose avec poignée  
*Rosa com alça*

**REF.06753**

Blanc avec poignée  
*Branco com alça*

**REF.06754**



u.m.vta: 1  50 



**REF.00132**

**Grand, deux côtes**  
*Grande, duas faces*





u.m.vta: 24  24



**REF.02185**

**Spéciale double**  
*Duplo especial*



u.m.vta: 12  120 



**REF.00774**

**Ongles avec poignées, Grand**  
*Com asas, Grande*



u.m.vta: 12  120 



**REF.00792**

**Ongles avec poignées, petit**  
*Com asas, pequeno*



**Bol manucure en acier inoxydable**  
**Bacia aço inoxidável manicure**



u.m.vta: 10  120

325 ml

**REF.03732**



**Bol manucure spécial**  
**Bacia especial manicure**

u.m.vta: 1  18 

**REF. 00889**





**Bol de manucure pour le trempage des doigts de couleur naturelle, ergonomique**  
**Tigela molha dedos cor natural, ergonômica**

u.m.vta: 20  20

**REF.03399**



**Ciseaux ronds d'oreille et de nez**  
**Tesoura de ponto redondo para orelha e nariz**

u.m.vta: 1  12 

4"

REF.07087



**Ciseaux bébé point roma**  
**Tesoura bebê ponto roma**



u.m.vta: 1  12 

3.5"

REF.07088



**Pinces à pince 3 en 1**  
**3 Em 1 forças de compressão**

u.m.vta: 1  10 

REF.07090



**Ciseaux droits professionnels à ongles**  
**Tesouras profissionais retas para unhas**

u.m.vta: 1  30

3.5"

REF.07353



**Ciseaux à peau droits professionnels**  
**Tesouras profissionais para peles retas**



u.m.vta: 1  30

3.5"

REF.07354



**Ciseaux à peau**  
**Tesoura peles**

u.m.vta: 1  12 



**REF.07085**



u.m.vta: 1  12 

**REF.04690**



u.m.vta: 1  12 

**REF.01270**

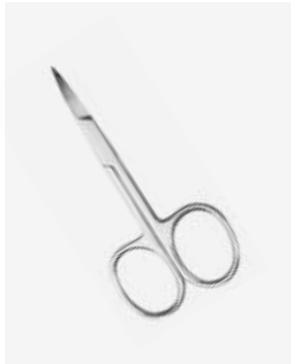

u.m.vta: 1  30

**REF.01989**

Professionnel  
Profissional





u.m.vta: 1  12

**REF.03419**

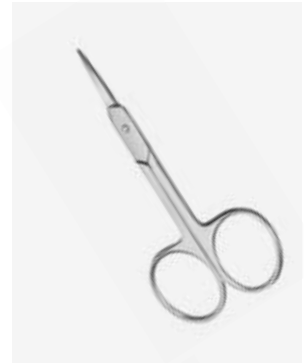
Pointe fine et  
surface  
de coupe  
courbée  
*Curvada ponta  
fina*



**Ciseaux à ongles**  
**Tesoura unhas**

u.m.vta: 1  12 

**REF.07086**

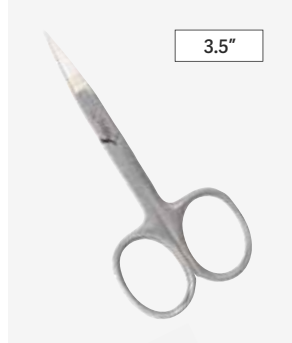

**REF.01269**

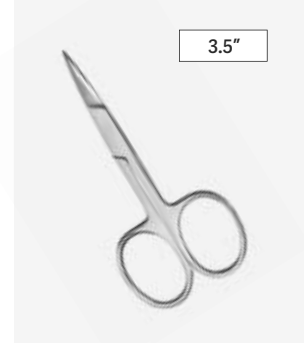



u.m.vta: 1  30

Professionnel  
Profissional

**REF.01990**



u.m.vta: 1  12 

**REF.04691**

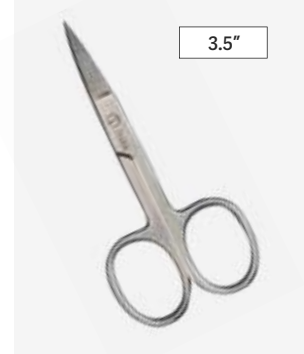

**Sachet de bâtons de manucure cuticule en plastique****Pacote removedor de cutículas plástico**u.m.vta: 10  10**REF.06567**

Ø 0,38 cm



7,5 cm

10 u

- Bois
- Madeira

u.m.vta: 10  10**REF.01279**

Ø 0,38 cm



12 cm

10 u

- Bois
- Madeira

u.m.vta: 10  10**REF.02716**

Ø 0,38 cm



15 cm

10 u



- Bois
- Madeira

u.m.vta: 50  50**REF.00121**

11,5 cm

50 u

- Plastique
- Plástico

u.m.vta: 1  10 **REF.06565**



Ø 0,38 cm



7,5 cm

100 u

- Bois
- Madeira

u.m.vta: 1  10 **REF.06566**



Ø 0,38 cm



15 cm

100 u

- Bois
- Madeira

u.m.vta: 1  80 **REF.00123**

Ø 0,38 cm



12 cm

100 u

- Bois
- Madeira

u.m.vta: 1  10**REF.04525**

Ø 0,38 cm



7,5 cm

1000 u

**REF.04526**

Ø 0,38 cm



12 cm

- Bois
- Madeira

## Pince coupe-ongles PÉDICURE

### Alicate corta-unhas PEDICURE

u.m.vta: 1  12**REF.03017**

Manche satiné  
Acier inoxydable  
Cabo mate  
Aço inoxidável



12 cm

**REF.01475**

Avec fermeture,  
finition brillant  
Com fecho,  
acabamento  
brilhante



12 cm

**REF.03016**

Manche satiné  
Acier inoxydable  
Cabo mate  
Aço inoxidável



14 cm

**REF.01474**

Avec fermeture,  
finition brillant  
Acier inoxydable  
Com fecho,  
acabamento brilhante  
Aço inoxidável

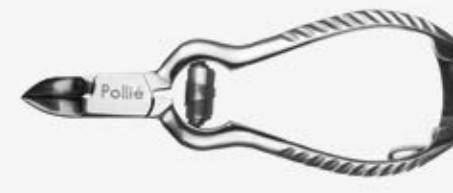

14 cm

u.m.vta: 1  10**REF.04695**

Mate, avec  
fermeture  
Mate, com fecho



12 cm

**REF.04694**

Mate, avec  
fermeture  
Mate, com fecho



14 cm



### Pince coupe-ongles PÉDICURE Alicate corta-unhas PEDICURE

u.m.vta: 1

10

**REF.07089**

Double droit avec  
ressorts  
*Dupla reta com  
molas*



14 cm

**REF.07136**

Oblique avec  
ressorts  
*Oblíquo com  
molas*



14 cm

### Coupe-ongles pédicure bleu titane Corta-unhas pédicure azul titanio

u.m.vta: 1

12

**REF.03241**

Avec fermeture  
*Com fecho*



12 cm

**REF.03242**

Avec fermeture  
*Com fecho*



14 cm

### Pincas coupe-ongles articulées pour pédicure - podologue Alicates podólogo articulado

u.m.vta: 1

1

**REF.02271**

15 cm

### Bol à pédicure en acier inoxydable

#### Bacia aço inoxidável pedicure

u.m.vta: 1  10

7 L

REF.03733



### Sachet séparateurs d'orteils



#### Pacote separa-dedos pedicure

u.m.vta: 50  50

REF.00846

- 2 unités
- Pédicures
- Blanc

- Bolsa 2 u
- Pedicure
- Branco

u.m.vta: 1  12 

REF.06755

- 2 unités
- En silicone

- Bolsa 2 u
- De silicone



### Râpes électriques anti-callosité

#### Raspadores de calosidades

u.m.vta: 1  24

REF. 04810



**Recharge**  
**Recarga**

**Sachet de 2 limes**  
**Saco com 2 limas**

REF. RE04810/01

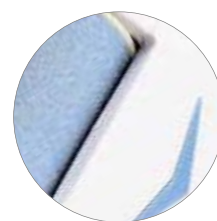

Cette Râpe électrique anti-callosité est un dispositif innovant créé pour adoucir la peau sèche et rugueuse et les callosités sur les pieds. Son rouleau tourne à 360° à une vitesse de 40 tours par seconde. Plus rapide et plus sûr que les râpes électriques conventionnelles. Cette Râpe électrique est conçue pour adoucir la peau épaisse sur les pieds et les talons.

Este raspador de calos é um dispositivo inovador criado para suavizar a pele seca e os calos dos pés. O seu cilindro gira a 360°, a uma velocidade de 40 vezes por segundo. É mais rápido e mais seguro que os raspadores de calos convencionais. Foi concebido para suavizar a pele dura dos pés e dos calcanhares.

## Crème pour les pieds TASSEL

### Crema pés TASSEL

u.m.vta: 1  12

400 ml

- Hydratant Intensif
- *Hidratante intensivo*

REF.06430

## Pieds exfoliants TASSEL

### Esfoliantes pés TASSEL

u.m.vta: 1  12



400 ml

- Au noyau d'abricot
- *Com semente de damasco*

REF.06431

## Adoucisseur liquide pour les cors et les callosités

### Amaciador líquido de durezas e calos

u.m.vta: 1  12 

500 ml

REF.04811

Gâce au adoucisseur liquide Pollié, il est plus facile d'éliminer les callosités et les cors pour obtenir des pieds jeunes et bien entretenus.

*Gaças ao líquido amaciador Pollié é mais fácil retirar os calos e as durezas para ostentar uns pés jovens e cuidadosos..*

06430





06431



## Grandes limes de pédicure

### Raspa-calos pedicura

u.m.vta: 1	 48	
------------	--	---

REF.06034

REF.06033

- Plastique
- Plástico

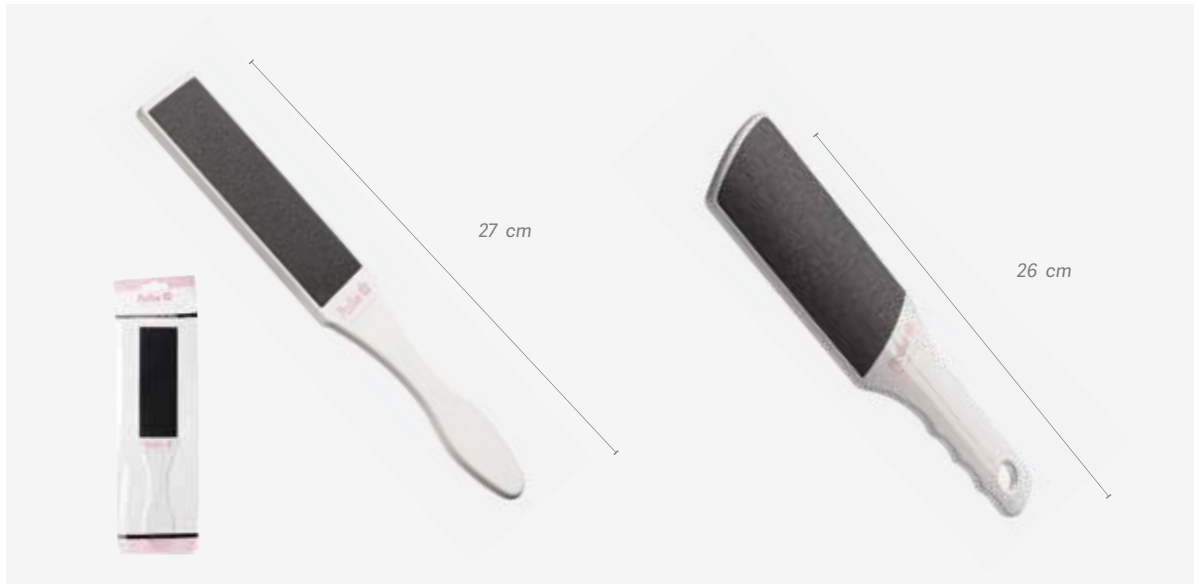

u.m.vta: 12	 12
-------------	--

REF.01068

- Métal
- Metálico



u.m.vta: 1	 30
------------	--

REF.04416

Limes transparentes en plastique, rigides et résistantes. pour enlever les callosités.  
Lime en céramique à double face

*Raspa-calos transparente de plástico rígido e resistente. Lima de cerâmica de dupla face*



## Grandes limes de pédicure



### Raspa-calos pedicure

u.m.vta: 12	 120
-------------	---

REF.04592

- Plastique
- Raspa-calos pedicure





u.m.vta: 1	 100	
------------	---	---

REF.01073



## limes de pédicure métallique avec poignée en caoutchouc soft

### Raspa-calos pedicure metálica com punho de borracha macia



u.m.vta: 1	 12	
------------	--	---

REF.06606/58



REF.06606/70

### limes de pédicure **PODORAPE Deux faces LAVABLE** *Raspa-calos pedicura podorape FACE DUPLA LAVÁVEL*

u.m.vta: 1	 12	
------------	--	---

REF.06611/58

REF.06611/59



REF.06611/70



Popadora blanc, bleu et rose double face, solide et doux, lavable avec une poignée incassable, conçue pour les podologues, ultra résistante et idéale pour les diabétiques en raison de l'efficacité et de la sécurité du gain.

Popadora branco, azul e rosa dupla face, um punho forte e macio, lavável com inquebrável, projetado para pedicura, ultra resistente e ideal para diabéticos por causa da eficácia e segurança do gão.

### Râpe-callosités pédicure *Raspa calosidades pedicura*



u.m.vta: 1	 12	
------------	--	---

REF.06709

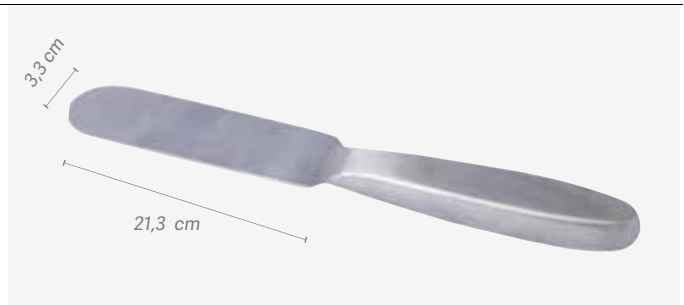
- Matériau : acier inoxydable
- avec poignée métallique
- Material: aço inoxidável
- Com punho metálico



### 50 Papiers abrasifs râpe-callosités *50 Recargas raspa calosidades*

u.m.vta: 1	 48	
------------	--	---

80

REF.06710

180

REF.06711







**Pierre ponce**  
**Pedra pomes**

u.m.vta: 1  48 

**REF. 06518**

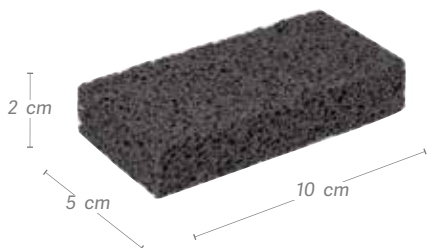
- Noire
- Cor preta



u.m.vta: 1  48 

- Banche
- Branca

**REF. 06517**





u.m.vta: 1  60 

- Grande ponce colorée
- Colorida Grande

**REF. 00942**



u.m.vta: 1  60 

- Couleurs assorties
- Cores sortidas

**REF. 02757**

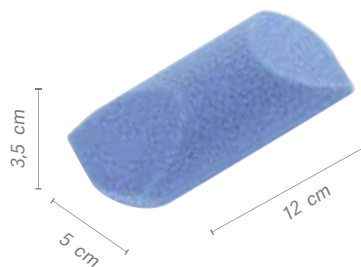

**Pierre ponce avec corde**  
**Pedra pomes com laço**

u.m.vta: 20  60

**REF.03061**



u.m.vta: 20  60

**REF.03062**



u.m.vta: 10  30

- Poisson
- Pés

**REF.03063**







u.m.vta: 20  60

- Ovale
- Ovalada

**REF.03065**



## Coupe-cors Corta calos

u.m.vta: 12  12u.m.vta: 12  12u.m.vta: 7  12 **REF.01102**

- Avec lame incluse
- *Corta calos com lâmina incluída*

**REF.01400**



- Avec manche en plastique et sans lame
- *Mango plástico sem lâmina*

**REF.01401**

- En acier inoxydable et sans lame
- *metálico inox. sem lâmina*



### Distributeur de lames de Coupe-cors anti-callosités pollié Dispensador lâminas corta calos pollié

u.m.vta: 1  100 

72 g

**REF.06459**

- Boîte de mesures de 100ud: 13cm x 7cm x 1cm
- Poids: 72g
- Feuille de mesures: 2,24cm x 0,01cm
- "Made in Germany"
- *Mede caixa de 100ud: 13cm x 7cm x 1cm*
- *Peso: 72g*
- *Folha de medidas: 2,24cm x 0,01cm*
- *"Made in Germany"*



Lames de rechange en acier pour couteaux. Surface plate et très fine. Des feuilles de qualité garantissant une coupe sûre pour éliminer les callosités excessives et / ou la dureté des pieds, grâce à sa lame de précision, à ses deux faces et à ses arêtes de coupe fines. Ils s'adaptent à tous les coupe-cors standard.

Lâminas de substituição de aço para cortadores. De superfície plana e muito fina. Folhas de qualidade com garantia de corte seguro para eliminar excesso de calos e / ou dureza nos pés, graças a sua lâmina de precisão, bordas de dois lados e cortes finos. Se adaptam a todos os cortadores standard.

## Reflexologie massage

### Massagem de reflexologia

u.m.vta: 1		4
------------	---	---

REF. 04809

- Baignoire de massage pour pieds SPA
- Puissance: 60W
- Avec cadran de fonction
- Massage vibrant et à bulles
- Semelle de massage de réflexologie en caoutchouc antidérapant

- Massajador de pés Spa
- Potência: 60W
- Com botão de função
- Massagem vibratória e de borbulhas
- Base de borracha antiderrapante

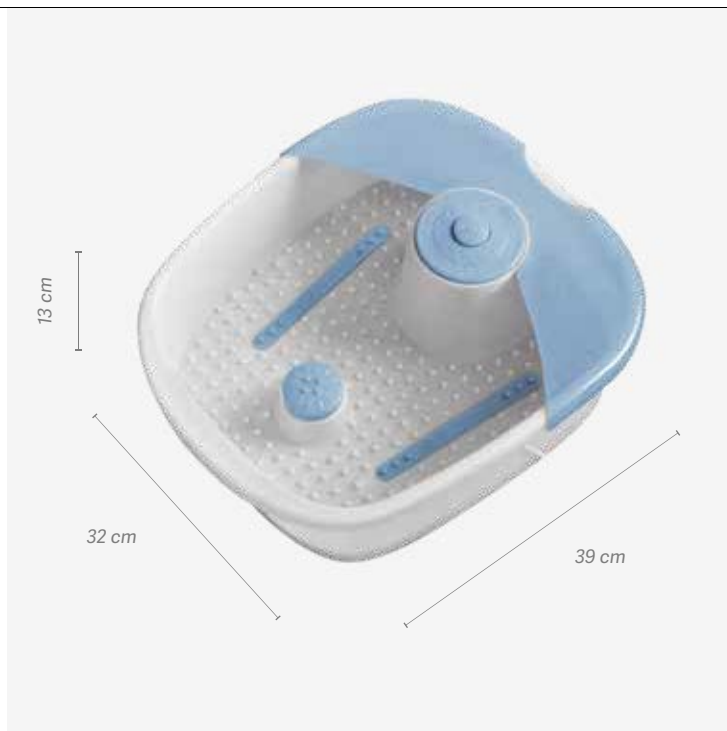

## Reflexologie massage

### Massagem de reflexologia

u.m.vta: 1		2
------------	---	---

REF. 04588

- Puissance: 60W
- Masseur pour les pieds relaxant
- 3 en 1: chauffage de l'eau, bulles et vibrations
- Réflexologie plantaire intense, massage inclus
- Avec drain pour faciliter la vidange
- Convient aux pieds jusqu'à la taille 44. Anti-dérapant
- Fonction de chauffage automatique
- Longueur du câble de connexion 175 cm

- Potência: 60W
- Massajador relaxante de pés
- 3 em 1: aquecimento de água, borbulhas e vibração
- Intensa reflexologia podal, com massagem incluída
- Com saída de a água para facilitar o esvaziamento
- Adequado para pés até ao tamanho 44. Antiderrapante
- Função de calor automática
- Cabo elétrico de 175 cm





MEDISANA®

**AQUATHERM: 3 EN 1**  
**AQUATHERM: 3 EM 1**u.m.vta: 1  2**REF. 02309**

- Puissance: 390W
- 3 en 1: massage par vibration et bulles avec chaleur infrarouge.
- Chauffage à eau réglable de 20 °C à 48 °C
- Minuterie: 20/30/40/50/60 minutes.
- L'heure et la température sont affichées sur l'écran de l'eau.
- Fonctions automatiques de lumière infrarouge et chaleur.
- Rouleaux de massage pour masser la partie interne des pieds.
- Gillés d'aération ergonomiques.
- Rouleaux de massage de base amovibles.
- Boîtier externe double épaisseur pour garder la chaleur.
- Réflexologie plantaire intense.
- Pour les pieds jusqu'à la taille 46
- Dimensions: 38,6 x 24,3 x 45,9 cm

- Potência: 390W
- 3 em 1: massagem por vibração e borbulhas com calor infravermelho.
- Aquecimento da água regulável desde os 20°C aos 48°C.
- Temporizador: 20/30/40/50/60 minutos.
- O Display mostra o tempo e a temperatura da água.
- Funções automáticas de luz infravermelha e de calor.
- Rolos de massagem para massajarem a parte interna dos pés.
- Saídas de ar ergonomicamente posicionadas.
- Rolos de massagem desmontáveis da base.
- Parte exterior duplamente reforçada para manter o calor.
- Reflexologia podal intensa.
- Para pés até ao tamanho 46
- Medidas: 38,6 x 24,3 x 45,9 cm

**Housse de protection**  
**Proteção massajador**u.m.vta: 1  10 **REF. 06109**

- Sachet de 100 housses de protection en polyéthylène de haute densité pour baignoires de pédicure
- Mesures: 48cm de large x45 long, côté pliable + 15cm. Hygiénique.
- Évitez tout contact entre les pieds du client et la baignoire.
- Polyéthylène transparent.
- Une seule utilisation. Jetable

- Pacote de 100 unidades de sacos protetores de polietileno de alta densidade para massajadores de pés.
- Medidas: 48cm de largura x 45 cm de comprimento, laterais desdobráveis +15cm, Higiénico.
- Evita o contato dos pés do cliente com o massajador.
- Polietileno transparente. Descartável.





05



## Maquillage Maquiagem

*Crayons, eye-liners, mascara, éponges de maquillage  
et de maquillage, pinceaux et pinceaux...*

*Lápis, delineadores, rímel, maquiagem e esponjas de  
maquiagem, escovas e pincéis...*



**Crayons POLLIE WATERPROOF**  
**Lápis POLLIE WATERPROOF**

u.m.vta: 1  12 

 Blanc · Branco  
**REF.03788**

 Noir · Cor preto  
**REF.03787**

 Bleu · Azul  
**REF.03790**

 Vert · Verde  
**REF.03789**

 Brun · Castanho  
**REF.03792**

 Gris · Cinzento  
**REF.03791**



12,5 cm

 Brun clair  
 Castanho claro  
**REF.03795**

 Marron foncé  
 Castanho escuro  
**REF.03798**

 Violet foncé  
 Roxo escuro  
**REF.03799**

 Rouge · Vermelho  
**REF.03796**

 Rose · Rosa  
**REF.03800**



12,5 cm

 Brun · Castanho  
**REF.03794**



12,5 cm



## Crayons cosmétique POLLIÉ BOIS

### Lápis POLLIÉ MADEIRA



Testé ophtalmologiquement  
Testado oftalmologicamente

u.m.vta: 1 10

Crayon pour les yeux Khol pour une utilisation sur la ligne des yeux intérieurs et extérieurs. Sa texture crémeuse est douce pour la ligne interne sensible et pour la zone délicate des yeux.

Lápis delineador Khol para uso na linha interna e externa dos olhos. Sua textura cremosa é suave para a linha interna sensível e para a delicada área dos olhos.

Noir Khol · Cor preto Khol

**REF.06398**

Crayon mince en bois extrudé. Application dans la ligne de l'oeil interne et externe  
Lápis fino de madeira extrudido. Aplicação na linha do olho interno e externo

Noir · Cor preto

**REF.06399**

Sa forte concentration en pigments rend la couleur résistante et durable dans le lacrymal.  
Sua alta concentração de pigmentos faz com que a cor seja resistente e durável nas lacrimais.

Brum · Castanho

**REF.06400**

Blanc · Branco

**REF.06402**

Vert · Verde

**REF.06403**

Gris · Cinzento

**REF.06404**

Bleu · Azul

**REF.06405**

Lilas · Lilás

**REF.06456**

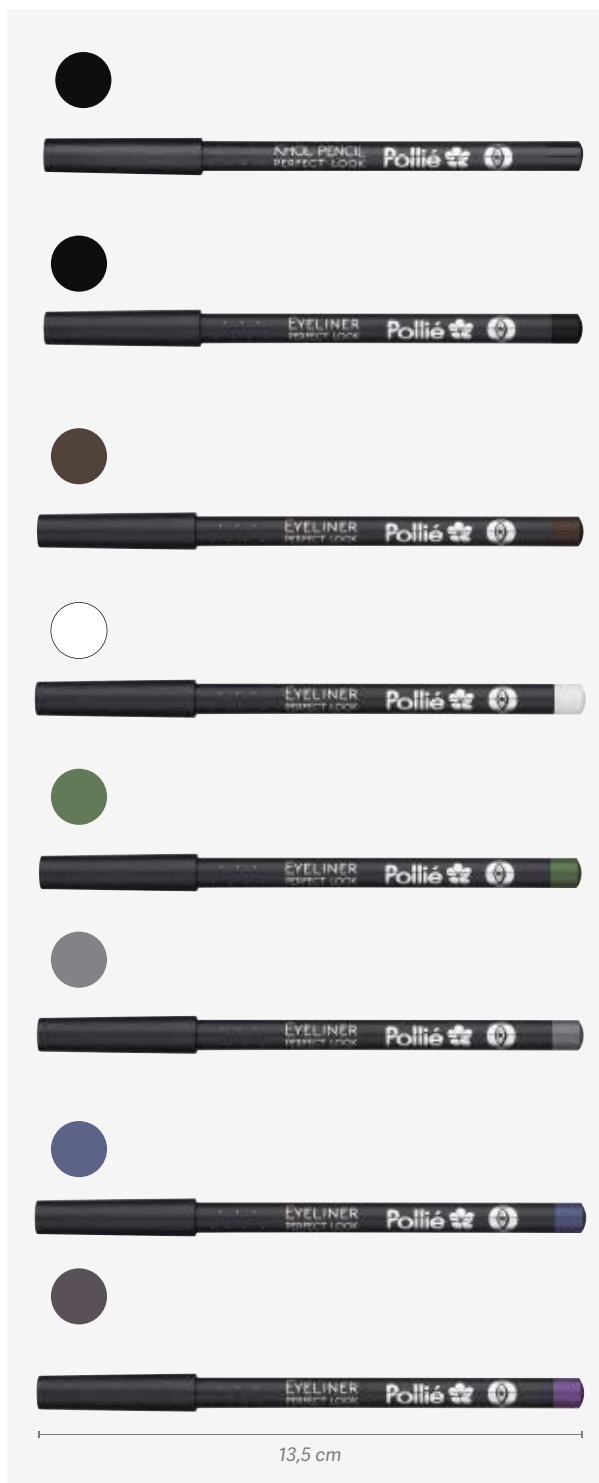

## Crayons cosmétique **POLLIE BOIS**

### Lápis **POLLIE MADEIRA**



u.m.vta: 1	10	
------------	----	--

Crayon mince en bois extrudé. Application sur le contour des lèvres et des lèvres  
Crayon à lèvres intense pour définir les lèvres en un seul coup. Il est appliqué agréablement et crémeux et est facile à appliquer avec un pinceau. Texture riche et couleur intense qui vous permet d'essayer la nouvelle façon de porter le crayon à lèvres dans une couleur mate

*Lápis fino de madeira. Aplicação no contorno dos lábios  
Intenso para definir os lábios de uma só vez. Aplica-se agradavelmente e cremoso e é fácil aplicar-se.  
Textura rica e cores intensas que permitem que experimente a nova maneira de usar o delineador em uma cor fosca.*

**REF.06406**

Brun clair  
Castanho claro

**REF.06407**

Vin  
Vinho

**REF.06408**

Brun moyen  
Castanho médio

**REF.06409**

Rouge foncé  
Vermelho escuro

**REF.06410**

Rose  
Rosa



13,5 cm

**Crayons cosmétique sourcil POLLIÉ bois**  
**Lápis sobancelha POLLIÉ madeira**



Testé ophtalmologiquement  
 Oftalmologicamente testado

u.m.vta: 1 10

Crayon mince en bois extrudé. Application sur les sourcils

Crayon à sourcils à la texture mélangable à sec pour définir, colorer et combler le sourcil de manière parfaite avec des traits de couleur doux. Utilisez le capuchon de la brosse pour peigner les sourcils avant l'application et même pour mélanger la couleur appliquée. Finition naturelle qui dure des heures.

*Lápis fino de madeira. Aplicação nas sobancelhas*

*Lápis de sobancelha com textura mista seca para definir, colorir e encher a sobancelha de uma forma perfeita com pinceladas de cores suaves. Use a tampa da escova para pentear a sobancelha antes da aplicação e até mesmo para misturar a cor aplicada. natural que dura horas.*

**REF.06396** Marron foncé  
 Marrom escuro



**REF.06397** Brun clair  
 Castanho claro

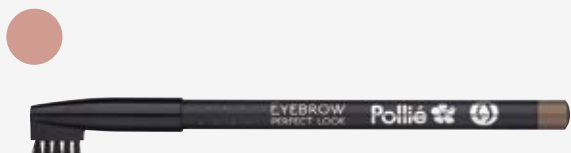

**REF.06455** Noir  
 Cor preto

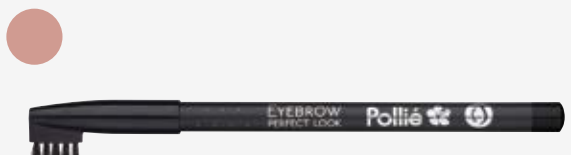

13,5 cm

**Présentoir pour crayons pour les yeux, sourcils ou lèvres**  
**Expositor de lápis de olhos, sobancelhas e lábios**

u.m.vta: 1 1

16 compartiments  
 16 compartimentos

Vide  
 Vazio

**REF.06807**

**REF.06807/01**



### Eyliner waterproof vegan 4 ml

### Eyliner waterproof vegan 4 ml

u.m.vta: 1  12



REF.07447

- Test ophtalmologique / Végan / Waterproof
- 12 unités boîte présentoir gratuite
- Teste oftalmológico/Vegan/ Waterproof
- Com 12 un. caixa expositora gratuita



### Mascara pour recourber les cils

### Máscara de pestanas

u.m.vta: 1  12 

Testé ophtalmologiquement  
Oftalmologicamente testado

### Glamglam volume et intensité

### Volume e intensidade glamglam

REF.06826

Etanche  
4D Volume  
Avec des cires naturelles

Impermeável  
Volume 4D  
Com ceras naturais



### Intensifier intense noir

### Intensificador intenso preto

REF.06827

Test dermatologique  
Cires naturelles  
X3 noir

Teste dermatológico  
Ceras naturais  
X3 preto



### Éponge cellulose pour démaquiller Esponja desmaquiagem celulose

u.m.vta: 12  360

  
**REF.01355**
  
**REF.01355/77**
u.m.vta: 2160  2160

#### Vrac · A granel

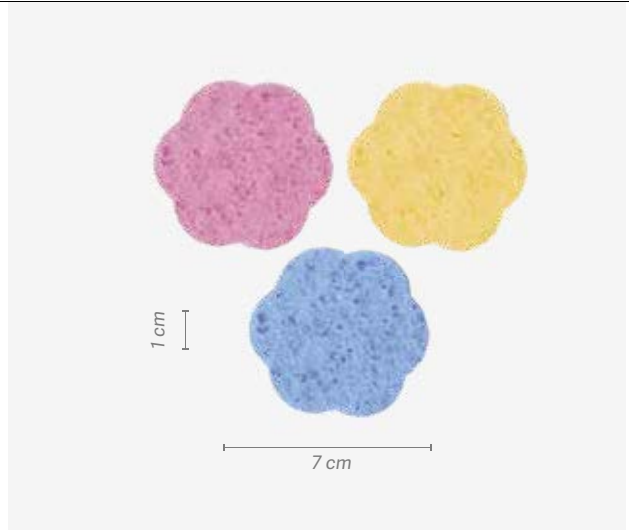

  
**REF.01355/70/01**   **REF.01355/77/01**   **REF.01355/59/01**
u.m.vta: 12  240



  
**REF.01938**   **REF.01938/77**
u.m.vta: 1080  1080

#### Vrac · A granel





  
**REF.01938/70/01**   **REF.01938/77/01**   **REF.01938/59/01**

### Éponge naturelle Esponja natural

u.m.vta: 1  16 **REF.02478**

Éponge naturelle pour le bain  
Esponja natural banho

u.m.vta: 1  72 **REF.02453**

Éponge naturelle de maquillage, de texture douce, adaptée aux peaux sensibles et délicates. Hypoallergénique.  
Esponja natural desmaquiagem, de textura suave, indicada para peles sensíveis e delicadas. Hipóalergénica.

**Sachet de 2 éponges plates minces pour enlever le maquillage**  
**Pacote 2 esponjas planas finas desmaquiagem**

u.m.vta: 12  240

REF.03166

u.m.vta: 12  180

REF.03165



**Humide**  
**Húmidas**



**Sachet serviette-éponge fine pour démaquiller**  
**Bolsa toalha esponja fina desmaquiagem**

u.m.vta: 12  180

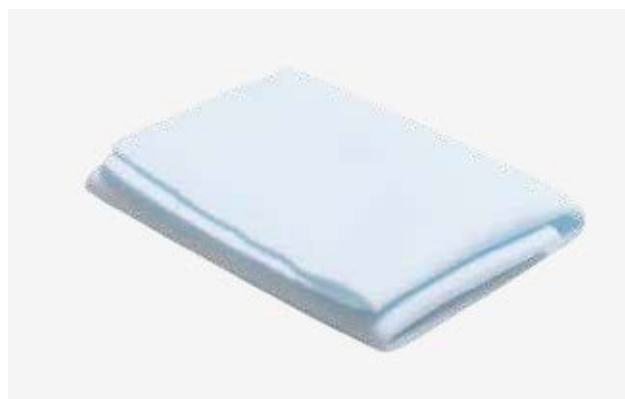
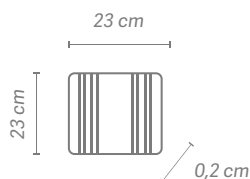
REF.03168



**Éponge non latex - polyuréthane**  
**Esponja não latex - poliuretano**

u.m.vta: 1  15 

REF.07128

REF.07127



**SCAN**  
**ME!**



Elle peut être utilisée sèche ou mouillée. Pour une utilisation à sec, elle est recommandée pour l'application du maquillage en poudre tel que les poudres compactes, fards à joues, ombres à paupières... Pour une utilisation humide, elle sert à appliquer les fonds de teint, crèmes, lotions et autres produits de maquillage liquides.

Pode utilizar a esponja molhada ou seca. Para utilização em seco, é adequada para aplicar maquiagem em pó como, pós compactos, blush, sombras... Para utilizar húmida, é boa para aplicar bases, cremes, loções e outros produtos de maquiagem líquidos.



## Sachet de 2 éponges cylindriques pour maquillage Pacote 2 esponjas cilíndrica maquiagem

u.m.vta: 12  180

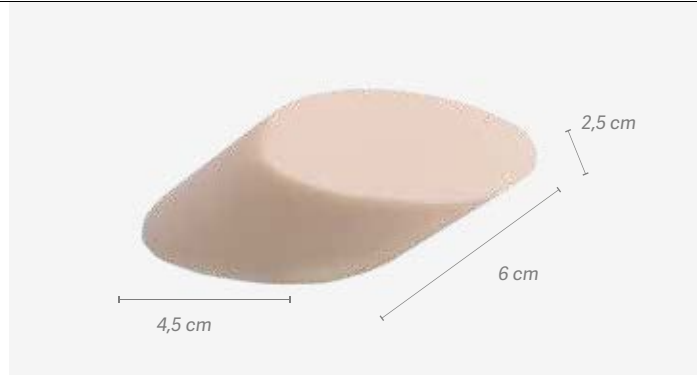

REF.03167



## Éponge de maquillage Esponja maquiagem

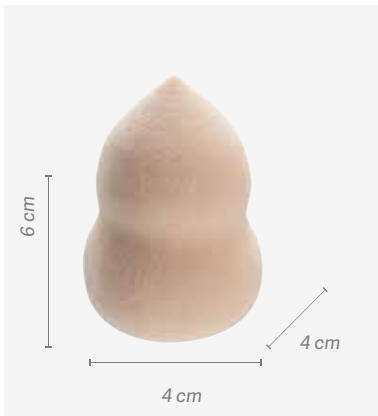

u.m.vta: 1  300

REF.03559

u.m.vta: 12  240

Set de 4 éponges de maquillage roses  
Esponja maquiagem rosa set-4

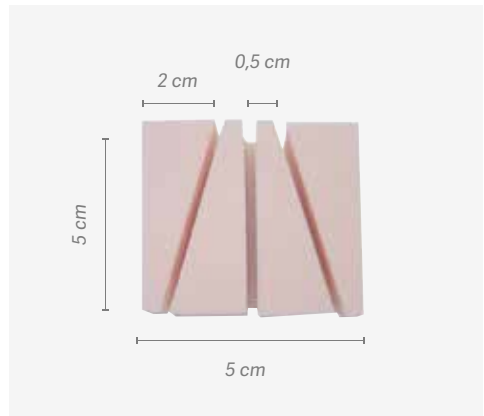
REF.01361

u.m.vta: 12  360

REF.01356

Latex NBR  
Látex NBR

u.m.vta: 12  240

REF.02898

Latex NBR  
Látex NBR

u.m.vta: 12  240

REF.02897



Latex NBR  
Látex NBR



### Éponge maquillage latex NBR Esponja maquiagem látex NBR

u.m.vta: 12  360

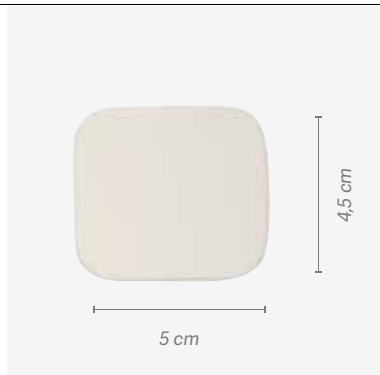
REF.01409

u.m.vta: 12  12

REF.02899



### Sachet de 2 éponges de maquillage latex Pacote 2 esponjas maquiagem látex

u.m.vta: 12  360

REF.01410

u.m.vta: 12  360



REF.01357



### Éponges maquillage Esponjas maquiagem

u.m.vta: 12  360

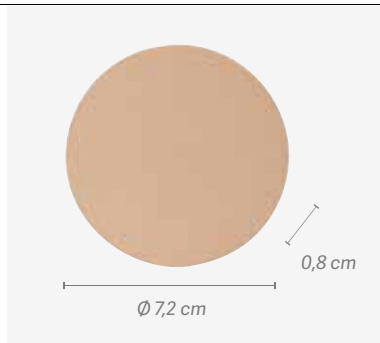

REF.01354

u.m.vta: 12  36

REF.01358

u.m.vta: 12  240

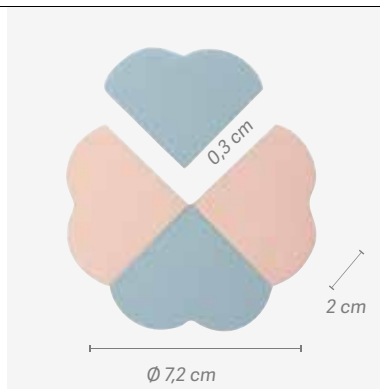
REF.02675





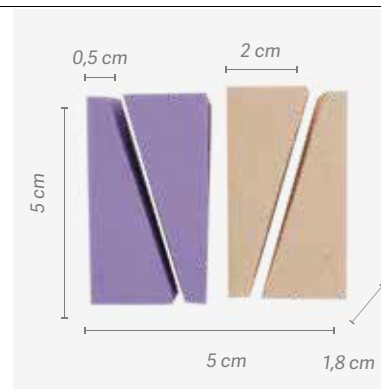





u.m.vta: 12  12

REF.01459



- Sachet de 4 éponges maquillage
- en forme de coeur
- Pacote 4 esponjas maquiagem corações

- Sachet de 12 éponges en latex
- Pacote 12 esponjas de látex

**Sachet éponges maquillage couleurs ASSORTIES****Pacote esponjas maquiagem diferentes cores**u.m.vta: 1  252 8 éponges  
8 esponjas**REF.01481**u.m.vta: 1  12 24 éponges  
24 esponjas**REF.02671**u.m.vta: 1  300 4 éponges  
4 esponjas**REF.02672**u.m.vta: 1  12 3 éponges maquillage + 2 glands  
3 esponjas maquiagem + 2 borlas**REF.02673**u.m.vta: 1  24 6 éponges  
6 esponjas**REF.02674**u.m.vta: 1  120 33 éponges  
33 esponjas**REF.02676****Eponge maquillage  
Esponja maquiagem**u.m.vta: 12  12**REF.01360**

- Rose
- Rosa

u.m.vta: 12  48**REF.01411**

- Moyen
- Média

u.m.vta: 12  36**REF.01359**

- Grande
- Grande



Ø 61 mm





Ø 70 mm



Ø 85 mm



**Pinceau blush ANGLED**  
**Pincel para blush ANGLED**

u.m.vta: 1	 12	
------------	--	---

**REF.07416**

Pinceau blush ANGLED  
 Pincel para blush ANGLED





u.m.vta: 1	 12	
------------	--	---

**REF.07408**

Pinceau blush  
 Pincel de blush





u.m.vta: 1	 11	
------------	--	---

**REF.07418**

Pinceau mélangeur  
 Pincel de mistura





**Pinceau mélangeur**  
**Pincel de mistura**

u.m.vta: 1	 1	
------------	---	---

**REF.07419**



**Pinceau mélangeur**  
**Pincel de mistura**



u.m.vta: 1	 50	
------------	--	---

**REF.07420**



## Brosse de maquillage pollié: manche en plastique, poils synthétiques

### Pinçel de maquiagem pollié: punho de plástico, cerdas sintéticas

u.m.vta: 1  6 

- **RÉSULTATS PROFESSIONNELS:** Pinceaux de maquillage professionnels faits de soies synthétiques de première qualité pour une application précise, lisse et sans égratignures. Chouchoutez votre peau avec des pinceaux de maquillage doux, faciles à entretenir et sans cruauté envers les animaux.
- **POLYVALENT:** Comprend une large gamme de brosses ovales pour une utilisation avec tous les produits tels que; comptage, base, correction des cernes, poussière ...
- **POIGNÉE DES BROSSES FLEXIBLES:** Les poignées des brosses ont été conçues pour se plier afin d'offrir une application facile du maquillage dans les zones difficiles d'accès.
- **APPLICATION DOUCE ET PRÉCISE:** Les poils souples de haute qualité assurent que les produits tels que les fondations, les correcteurs liquides, les crèmes BB, les fards et les poudres peuvent être appliqués uniformément et doucement.

- **RESULTADOS PROFISSIONAIS:** Pincéis de maquiagem profissional feitos de cerdas sintéticas premium para aplicação, suave e sem riscos. Mime a sua pele com pincéis suaves de maquiagem, fáceis de manter e livre de crueldade contra os animais.
- **MULTIFUNCIONAL:** Inclui uma ampla gama de escovas ovais para uso com todos os produtos, como; countorning, base, correção de olheiras, poeira ...
- **PUNHO DOS PINCEIS FLEXÍVEIS:** Os punhos dos pincéis foram projetadas para dobrar, a fim de oferecer uma fácil aplicação de maquiagem em áreas de difícil acesso.
- **APLICAÇÃO SUAVE:** As cerdas de alta qualidade garantem que produtos como fundações, corretores líquidos, cremes BB, blushes possam ser aplicados uniformemente e suavemente.

#### REF.06059

- Rond grande
- Rodada grande



#### REF.06060

- Rond moyen
- Rodada médio



#### REF.06061

- Ovale grande
- Oval grande



#### REF.06062

- Oval petite
- Oval pequeno



#### REF.06063

- Rond mini
- Rodada mini



#### REF.06064

- Set de 5 pinceaux
- Set 5 pincéis





**Pinceau à paupières**  
**Pincel de sombra**

u.m.vta: 1 25

N°7

**REF.07393**



N°6

**REF.07394**



N°5

**REF.07395**



N°4

**REF.07396**



N°3

**REF.07397**



N°2

**REF.07398**



N°1

**REF.07399**

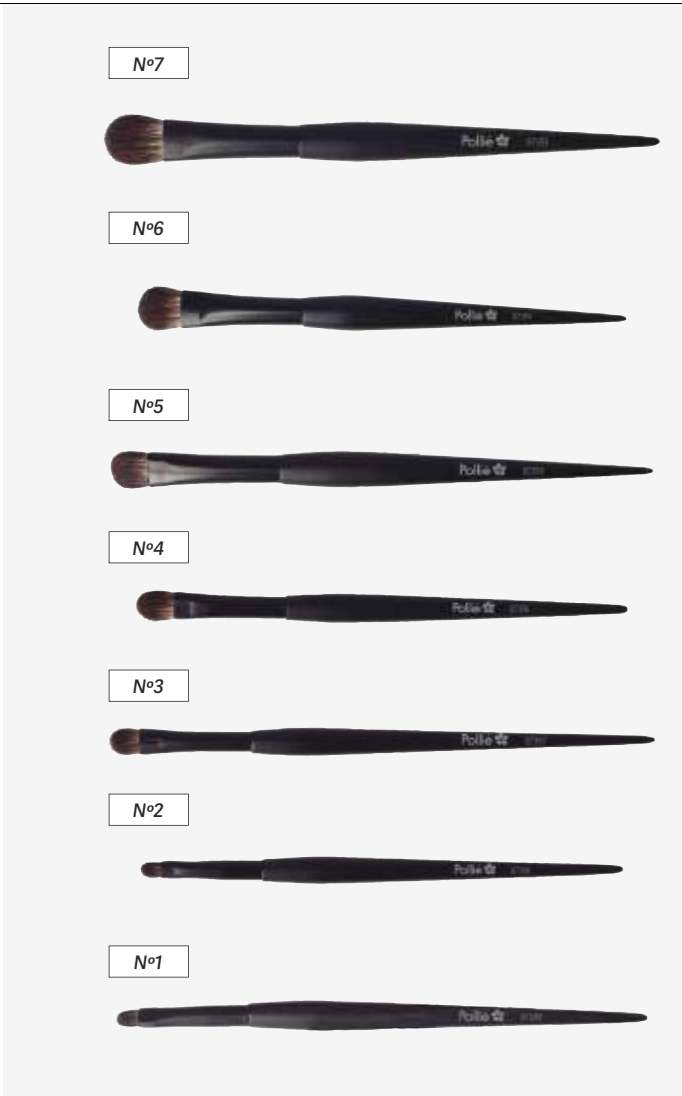

**Pinceau eye-liner**  
**Pincel eyeliner**

u.m.vta: 1 25

**REF.07400**



**Pinceau mélangeur eyeliner**  
**Pincel De Mistura De Delineador**



u.m.vta: 1 25

**REF.07401**





**Pinceau de guérison / flou**  
**Pincel de cura / desfoque**

u.m.vta: 1  25 

**REF.07402**

N°5



**REF.07403**

N°4



**REF.07404**

N°3



**REF.07405**

N°2





**REF.07406**

N°1





**Ombres de nez de brosse de contour**  
**Sombras de contorno em escova de contorno**

u.m.vta: 1  25 

**REF.07407**





**Pinceau correcteur de maquillage**  
**Pincel corretivo de maquiagem**

u.m.vta: 1  25 

**REF.07409**





**Pinceau à lèvres rétractable**  
**Pincel de lábios retrátil**

u.m.vta: 1  25 

**REF.07410**





**Brosse de mélange de sourcils**  
**Pincel para misturar sobrancelha**

u.m.vta: 1  25 

**REF.07411**





**Brosse peigne à sourcils**  
**Pincel pente para sobrancelha**

u.m.vta: 1  25 

**REF.07417**



**Pinceau FOUNDATION**  
**Pincel FOUNDATION**

u.m.vta: 1  12 

**N°4**

**REF.07412**



**N°3**

**REF.07413**



**N°2**

**REF.07414**



**N°1**

**REF.07415**







## **Pincesaux professionnel KABUKI** **Pincéis profissional KABUKI**

Les pinceaux Kabuki sont considérés comme les meilleurs pour l'application du maquillage, des ombres à paupières ou du rouge. L'utilisation de ceux-ci, procure une sensation de douceur extrême comme une caresse sur la peau du client et permet une finition parfaite. Ils sont indispensables pour un professionnel de maquillage.

Os pincéis Kabuki são considerados os melhores para a aplicação da maquiagem, as sombras de olhos ou o gloss. A utilização destes, confere uma sensação de suavidade extrema como uma carícia na pele do cliente e permite um acabamento de estrela de cinema. São indispensáveis para um profissional da maquiagem.

### **Brosse KABUKI** **Pincéis KABUKI**

Synthétique  
Sintético

u.m.vta: 1  12 

Conique  
Cónico

**REF.04094**



Angle  
Ângulo

**REF.04095**



Rond  
Redondo

**REF.04096**



Plat  
Plano

**REF.04097**



Conique d'ombre à paupières  
Sombra cónico

**REF.04111**



Conique d'ombre à paupières  
Sombra cónico

**REF.04098**



Angle d'ombre à paupières  
Sombra ângulo

**REF.04099**



Plat d'ombre à paupières  
Sombra plano

**REF.04101**



**Pinceau brosse Kabuki**  
**Pinel Kabuki**

Synthétique  
Sintético

u.m.vta: 1	 12	
------------	--	---

**REF.04703**

Rond  
Rodada



**REF.04704**

Oblique  
Oblíquo





**REF.04705**

Émoussé  
Contudente



Synthétique  
Sintético

u.m.vta: 1	 12	
------------	--	---

Rond  
Redondo

**REF.04100**



Avec éponge en latex  
Espanja látex

**REF.04102**



Cconique  
Cónico pequeno

**REF.04112**



Rond  
Redondo

**REF.04113**



Étroit  
Estreito

**REF.04114**





Plat droit  
Plano reto

**REF.04115**



## Brosse de maquillage

### Escovas de maquiagem

u.m.vta: 1  12 

Pinceau à poudre  
Pincel de pó

REF.07390

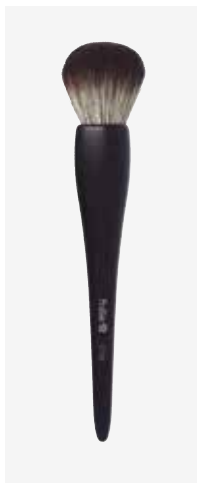

Pinceau contour / coloret  
Pincel de contorno / coloret

REF.07391



Pinceau surligneur  
Pincel iluminador

REF.07392

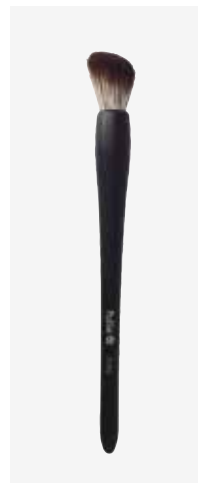

## Pinceau brosse cosmétique et pinceaux de maquillage KABUKI

### Escovas de maquiagem e escova cosmética KABUKI

u.m.vta: 1  12

REF.03561

- Pinceau de maquillage poils naturels
- Diamètre des cheveux: 27,5 mm
- Emballage: sac plastique individuel
- Idéal pour transporter sans prendre de place

- Pincel de maquiagem pêlo sintético/Taklon
- Diâmetro do cabelo: 27,5 mm
- Embalagem: Saco plástico individual
- Ideal para transportar sem ocupar espaço



## Pinceau brosse cosmétique et pinceaux de maquillage KABUKI

### Pincel de maquiagem e escova cosmética KABUKI

u.m.vta: 12  72

REF.01812

- Brosse cosmétique sachet inclus
- manche en plastique
- Poils de chèvre

- Pincel cosmética bolso, punho de plástico
- Cerdas de cabra

u.m.vta: 1  120

REF.03560

- Brosse de maquillage en poil naturel
- Diamètre des cheveux: 27,5 mm
- Emballage: sac plastique individuel
- Idéal pour transporter sans prendre de place

- Pincel de maquiagem cerdas natural
- Diâmetro do cabelo: 27,5 mm
- Embalagem: Saco plástico individual
- Ideal para transportar sem ocupar espaço

**Pinceaux manche en bois****Pincéis cabo madeira**

u.m.vta: 1



12

**REF.02884**

Pinceau nuance. Poils de chèvre  
Pincel colorir. Cerdas de cabra

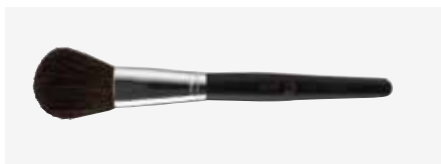
**REF.02885**

• Pinceau matizer. Poils de chèvre  
• Pincel matizador. Cerdas de cabra

**REF.02886**

Pinceau diffuseur. Poils d'écureuil  
Pincel esfumado. Cerdas de esquila

**REF.02887**

Pinceau d'ombre. Poils d'écureuil  
Pincel sombra. Cerdas de esquila

**REF.02888**

Pinceau pour les yeux. Poils de marte  
Pincel olhos. Cerdas de marta

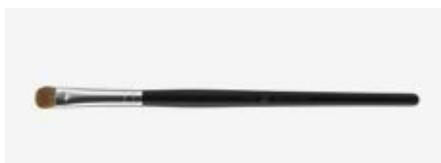
**REF.02889**

Pinceau d'ombre. Poils de marte  
Pincel sombra. Cerdas de marta

**REF.02890**

Pour les yeux. Poils de marte  
Para olhos. Cerdas de marta

**REF.02891**

À lèvres. Poils de marte  
Lábios. Cerdas de marta

**REF.02892**

À lèvres. Poils de marte  
Lábios. Cerdas de marta

**REF.02893**

Ayant éponge en latex  
Esponja látex

**REF.02894**

• Pinceau masque  
• Poils de nylon  
• Pincel máscara  
• Cerdas de nylon

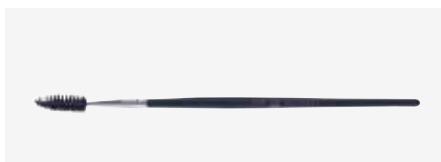
**REF.02895**

• Pinceau en poil de sanglier  
• Mascara pour recourber les cils  
• Pincel javali  
• Pente profissional máscara





## Pinceaux manche en bois

### Pincéis punho de madeira

u.m.vta: 1

12

**REF.01814**

- Brosse cosmétique à base de matériau de matage
- Poils de chèvre
- *Pincel cosmética matizadora brush*
- *Cerdas de cabra*

**REF.01815**

- Brosse cosmétique blush
- Poils de chèvre
- *Pincel cosmética colorir*
- *Cerdas de cabra*

**REF.01816**

- Brosse éponge cosmétique
- *Pincel cosmética esponja*

**REF.01817**

- Brosse cosmétique pour les yeux
- Poils de marte
- *Pincel cosmética olhos*

**REF.01818**

- Brosse (pinceau) cosmétique d'ombre
- Poils de chèvre + poney
- *Pincel cosmética sombra*
- *Cerdas de cabra + pony*

**REF.01819**

- Pinceau cosmétique de lèvres
- Poils de chèvre + poney
- *Pincel cosmética lábios*
- *Cerdas de cabra + pony*

**REF.01821**

- Brosse (pinceau) cosmétique d'ombre
- Poils de chèvre + poney
- *Pincel cosmética sombra*
- *Cerdas de cabra + pony*

**REF.01820**

- Pinceau brosse / peigne Cils et Sourcils
- Poils de sanglier
- *Pincel pente máscara*
- *Cerdas de javali*



## Idéal maquillage fluide

### Maquiagem fluida ideal

Synthétique  
Sintético**REF.04511**

- Mache en plastique
- *Punho de plástico*

**REF.04512**

- Mache en bois
- *Punho madeira*



## Pinceaux brosse manche en bois

### Pincéis punho de madeira

u.m.vta: 1  12 

**REF.01800**

- Pinceau nuance
- Poils de chèvre
- Pincel matizador
- Cerdas de cabra

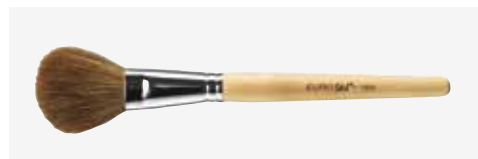

**REF.01801**

- Pinceau blush
- Poils de chèvre
- Pincel colorir
- Cerdas de cabra



**REF.01802**

- Pinceau masque
- Poils de cochon
- Pincel máscara
- Cerdas de porca



**REF.01803**

- Pinceau maquillage ventilateur
- Poils de chèvre
- Pincel leque
- Cerdas de cabra



**REF.01804**

- Pinceau yeux
- Poils de marte
- Pincel olhos
- Cerdas de marta



**REF.01805**

- Pinceau à lèvres
- Poils de marte
- Pincel lábios
- Cerdas de marta



**REF.01806**

- Pinceau ombre
- Poils de chèvre + poney
- Pincel sombra
- Cerdas de cabra + pony



**REF.01807**

- Pinceau d'ombre
- Poils de chèvre + poney
- Pincel sombra
- Cerdas de cabra + pony



**REF.01808**

- Pinceau éponge latex
- Pincel esponja latex



**REF.01809**

- Pinceau masque
- Nylon
- Pincel máscara
- Nylon



**REF.01810**

- Pinceau-peigne mascara
- Poils de sanglier
- Máscara escova-pincel
- Cerdas de javali



**Présentoir 66 pinceaux cosmétiques**  
**Expositor 66 pincéis cosmética**

u.m.vta: 1  2

**REF.01466**



Pour plus d'informations sur les pinceaux, voir page 757  
 Para mais informação sobre os pincéis consultar página 757

**Pinceaux 12 unités**  
**Pincéis 12 units**

u.m.vta: 12  12

**REF.01508**

- Double éponge
- Dupla esponja



u.m.vta: 12  12

**REF.01509**

- Pinceau /éponge
- Pincel/esponja





**Taille-crayon**  
**Afiador**

u.m.vta: 12  60

**REF.01067**

- Normal/ épais
- Normal/grossa



u.m.vta: 12  72 

**REF.06364**

- Taille-crayon double cosmétique
- Afiador duplo cosmética



**Sachet d'applicateurs d'ombre**  
**Bolsa aplicadores sombra**

u.m.vta: 12  120

5 u

**REF.01505**

- Couleurs
- Cor es



u.m.vta: 12  240

5 u

**REF.01507**



u.m.vta: 12  120

12 u

**REF.01506**

- Couleurs
- Cor es



**Nettoyant à la silicone pour les pinceaux de maquillage**  
**Limpador de silicone para pincéis de maquiagem**

u.m.vta: 1  12

**REF.04706**





**Étui rond de 7 pinceaux maquillage avec miroir**  
**Estojo redondo 7 pincéis maquiagem com espelho**

u.m.vta: 1  6 

**REF.03562**



### Set de 12 pinceaux Set 12 pincéis cosmética

u.m.vta: 1		6	
------------	---	---	---

- Contient: 02884, 02885, 02886, 02887, 02889, 02890, 02891, 02892, 02893, 02894, 02895.
- Contém: : 02884, 02885, 02886, 02887, 02889, 02890, 02891, 02892, 02893, 02894, 02895.



REF. 02896

Pour plus d'informations sur les pinceaux, reportez-vous 755

Para mais informação sobre os pincéis consultar página 755





### Étui de 7 pinceaux de maquillage en poils synthétiques Estojo 7 pincéis maquiagem pêlo sintético

u.m.vta: 1		6	
------------	---	---	---

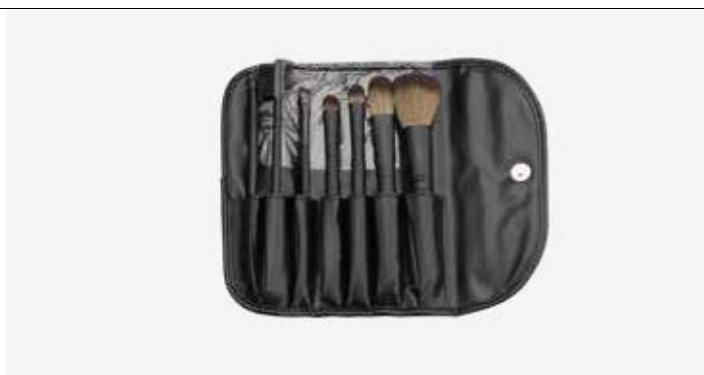
REF.03563



### Étui de pinceaux cosmétiques (VIDE) Estojo pincéis cosmética (VAZIO)

u.m.vta: 1		120	
------------	---	-----	---

REF.03564



### Set de 5 pinceaux Set 5 pincéis

u.m.vta: 12		120
-------------	---	-----

REF.02585

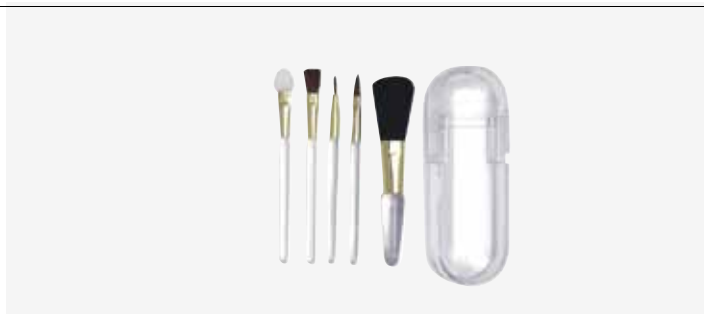



06

## Faux-cils Pestanas

*Faux cils complets, faux-cils individuels, faux  
cils adhésifs, sourcils...*

*Pestanas completos, pestanas individuais,  
pestanas adesivos, sobrancelhas...*



## Faux cils POLLIÉ noirs individuels Pestanas POLLIÉ pretos individuais

u.m.vta: 1  50

### Faux-cils individuels en quatre étapes

1. Nettoyer vos cils naturels et vos paupières afin qu'il ne reste aucune trace de maquillage, ni d'impuretés.
2. Retirer les faux-cils de la boîte avec les pinces Pollié (ref 06562).
3. Appliquer une goutte de colle sur le papier métallique et imbiber la base du faux-cil avec la colle.
4. Placer l'extension sur le cil naturel proche de la ligne des cils SANS TOUCHER la paupière. Appliquer autant de cils que souhaité afin d'obtenir le résultat désiré.

### Comment retirer vos faux-cils Pollié?

Imprégner deux cotons avec le dissolvant à faux-cils Pollié. Placer un coton sous les faux-cils et l'autre dessus. Frotter délicatement jusqu'à ce que se décollent les faux-cils.

### Pestanas individual em 4 passos

1. Limpe as suas pestanas naturais e as pálpebras para que estejam sem maquilhagem e impurezas.
2. Extraia as pestanas da caixa com as pinças Pollié (ref 06562).
3. Aplique uma gota de adesivo no papel metálico e ensope a base da pestana com o adesivo.
4. Coloque a extensão sobre a pestana natural perto da linha das pestanas SEM TOCAR na pálpebra. Aplique tantas pestanas quanto desejar para conseguir o resultado desejado.

### Como retirar as pestanas Pollié?

Embeber dois algodões com o removedor de pestanas Pollié. Colocar um algodão debaixo das pestanas e outro por cima. Esfregue-os suavemente até que as pestanas descolem.

REF.06508

- Courts
- Noir
- Curto
- Cor preto



REF.06509

- Moyens
- Noir
- Mídia
- Cor preto



REF.06510

- Longs
- Noir
- Long
- Black



REF.06511

- Mixte
- Noir
- Misturado
- Cor preto



REF.06512

- Courts
- Dúo
- Curto
- Duo



REF.06513

- Moyens
- Dúo
- Mídia
- Duo



REF.06514

- Long
- Noir
- Longo
- Cor preto



REF.06515

- Courts
- Trio
- Curto
- Trio



REF.06516

- Moyens
- Trio
- Mídia
- Trio



REF.06519

- Longs
- Trio
- Longo
- Trio





## Faux-cils POLLIÉ noirs 100% naturels Pestanas POLLIÉ cor preto 100% natural

u.m.vta: 1 50



### Faux-cils complets en 4 étapes

Adaptation des faux cils à la taille correcte: Aligner les faux-cils avec votre ligne naturelle de cils et couper l'excès.

Application de la colle: Appliquer une fine ligne de colle tout le long de la bande et attendre 20-30 secondes. En cas d'excès de colle, utiliser du lait démaquillant pour éliminer les surplus.

Pose des faux cils: Placer les faux-cils avec colle sur la ligne naturelle de vos cils et appuyer légèrement jusqu'à les fixer.

Retouche finale: Utiliser les pinces Pollié (ref 06314) pour ajuster les faux-cils de sorte qu'ils soient bien alignés et fixés.

### Comment retirer vos faux-cils Pollié?

Décoller la bande de faux-cils en commençant par le coin externe. Placer les cils dans leur boîte pour les réutiliser dans le futur.

### Pestanas completas em 4 passos

Adaptar as pestanas à medida correcta: Alinhar as pestanas com a sua linha natural de pestanas e recortar no caso de excesso.

2Aplicação do adesivo: Aplicar uma linha fina de adesivo ao longo da tira e esperar 20-30 segundos. No caso de ter excesso de adesivo, utilize desmaquilhante para eliminar a parte que sobra.

Aplicação das pestanas: Coloque as pestanas com adesivo em cima da linha natural, pressionando ligeiramente até as fixar.

Retoque final: Utilizar as pinças Pollié (ref 06314) para ajustar as pestanas de forma a que fiquem bem alinhadas e fixas.

### Como retirar as suas pestanas Pollié?

Desprender a tira de pestanas começando pelo extremo exterior. Coloque as pestanas na sua Caixa para voltar a utilizá-las num futuro

REF.06487



N°1

REF.06488



N°2

REF.06489



N°3

REF.06490



N°4

REF.06491



N°5

REF.06492



N°6

REF.06493



N°7

REF.06494



N°8

REF.06495



N°9

REF.06496



N°10



## Faux-cils POLLIÉ noirs 100% naturels Pestanas POLLIÉ cor preto 100% natural

u.m.vta: 1  50

### Faux-cils complets en 4 étapes

Adaptation des faux cils à la taille correcte: Aligner les faux-cils avec votre ligne naturelle de cils et couper l'excès.  
Application de la colle: Appliquer une fine ligne de colle tout le long de la bande et attendre 20-30 secondes. En cas d'excès de colle, utiliser du lait démaquillant pour éliminer les surplus.

Pose des faux cils: Placer les faux-cils avec colle sur la ligne naturelle de vos cils et appuyer légèrement jusqu'à les fixer.

Retouche finale: Utiliser les pinces Pollié (ref 06314) pour ajuster les faux-cils de sorte qu'ils soient bien alignés et fixés.

### Comment retirer vos faux-cils Pollié?

Décoller la bande de faux-cils en commençant par le coin externe. Placer les cils dans leur boîte pour les réutiliser dans le futur.

### Pestanas completas em 4 passos

Adaptar as pestanas à medida correcta: Alinhar as pestanas com a sua linha natural de pestanas e recortar no caso de excesso.  
2Aplicação do adesivo: Aplicar uma linha fina de adesivo ao longo da tira e esperar 20-30 segundos. No caso de ter excesso de adesivo, utilize desmaquilhante para eliminar a parte que sobra.

Aplicação das pestanas: Coloque as pestanas com adesivo em cima da linha natural, pressionando ligeiramente até as fixar.

Retoque final: Utilizar as pinças Pollié (ref 06314) para ajustar as pestanas de forma a que fiquem bem alinhadas e fixas.

### Como retirar as suas pestanas Pollié?

Desprender a tira de pestanas começando pelo extremo exterior. Coloque as pestanas na sua Caixa para voltar a utilizá-las num futuro

REF.06497



N°11

REF.06498



N°12

REF.06499



N°13

REF.06500



N°14

REF.06502



N°15

REF.06503



N°16

REF.06504



N°17

REF.06505



N°18

REF.06506



N°19

REF.06507



N°20

**Set 3 pinces individuelles cil par cil**  
**Conjunto 3 pinças individuais cerdas ao cerdas**

**Pollié** 

u.m.vta: 1  12

**REF.06562**

Ensemble de 3 clips pour le placement des faux-cils et extensions de cils. Étui métallique inclus.

Conjunto de 3 cliques para colocação de cílios e extensões de cílios. Com um estojo de metal





### QUELLE FORME DE YEUX AVEZ-VOUS?

Déterminer la forme des yeux est la première étape pour décider quel style de cils est convenable

#### YEUX RONDS

Faux cils classiques, mélange de courts et de longs qui adoucissent le regard: réf 02700, 02693, 02695, 04079

#### YEUX EN AMANDE

Faux cils denses et plus fins vers les pointes: Réf 02690, 02691, 02698, 02699, 02701..

#### YEUX ENFONCÉS OU PETITS

Faux Cils à faible densité et longs pour ouvrir le regard: réf 02696, 02697, 02692, 02694..

### QUE FORMA TEM O SEU OLHO?

Determinar a forma dos olhos é o primeiro passo para decidir que estilo de pestanas é adequado para si.

#### OLHOS REDONDOS

Pestanas clássicas, mistura de curtas e largas suavizam o olhar: Ref. 02700, 02693, 02695, 04079.

#### OLHOS AMENDOADOS

Pestanas densas e mais finas até às pontas: Ref. 02690, 02691, 02698, 02699, 02701

#### OLHOS FUNDOS OU PEQUENOS

Pestanas pouco numerosas e largas para abrir o olhar: Ref. 02696, 02697, 02692, 02694..

## Comment utiliser?

### Como usar



### FAUX-CILS COMPLETS PESTANA COMPLETA

1. Prenez la mesure avec vos yeux et coupez l'excès.
2. Appliquez une fine ligne d'adhésif le long de la bande. Attendez 30 secondes pour ajuster.
3. A l'aide d'une paire de pinces, placez sur la paupière à la naissance des cils.
4. Maquiller et vous êtes fin prêt!

1. Tomar a medida do seu olho e cortar o excedente.
2. Aplique uma linha delgada de adesivo ao longo da banda. Esperar 30 seg. para ajustar.
3. Com ajuda dumas pinças colocar sobre a pálpebra na raiz das pestanas.
4. Maquilhar e está pronto!



### Faux-cils individuel: Pestana individual:

1. Prenez un faux cil avec pinces.
2. Mouiller la base en adhésif
3. Placez à la naissance des cils. Jamais sur la paupière.
4. Maquiller et vous êtes fin prêt!



1. Pegue a pestana com umas pinças.
2. Molhar a base ao adesivo
3. Colocar na raiz das pestanas. Nunca na pálpebra.
4. Maquilhar e está pronto!

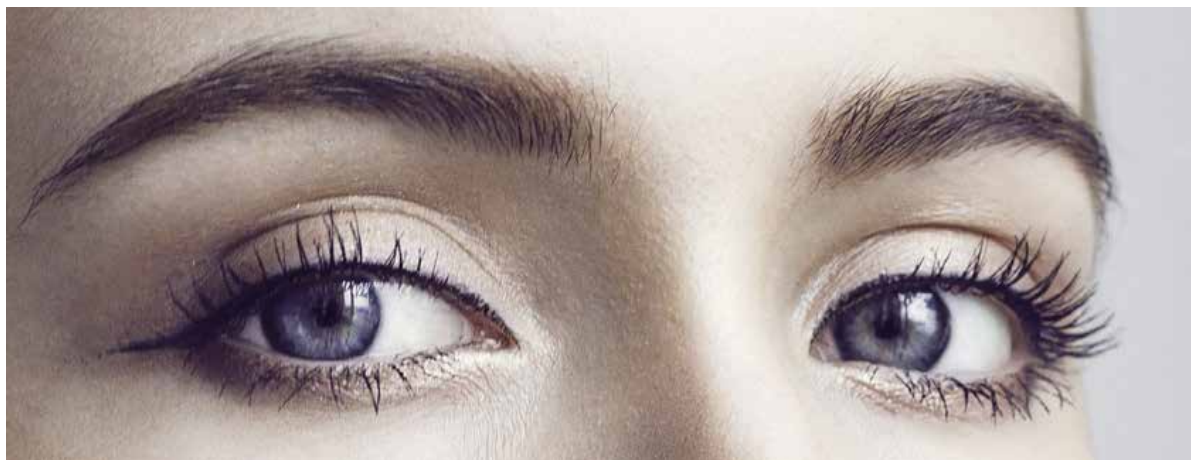

**Avoir un look naturel et sophistiqué**  
**Para um look natural e sofisticado**



**Pinces pour faux-cils**  
**Pinças para pestanas postiças**

u.m.vta: 1  12 

**REF.06314**



Aident à placer les faux-cils  
Ajuda a colocar as pestanas

**Faux-cils Andrea SM**  
**Pestanas Andrea SM**u.m.vta: 4  7262 noir  
62 cor preto

REF.02700

21 noir  
21 cor preto

REF.02690

23 noir  
23 cor preto

REF.02692

28 noir  
28 cor preto

REF.02694

45 noir  
45 cor preto

REF.02696

53 noir  
53 cor preto

REF.02698

70 noir  
70 cor preto

REF.02701

21 marron  
21 castanho

REF.02691

26 noir  
26 cor preto

REF.02693

33 noir  
33 cor preto

REF.02695

45 marron  
45 castanho

REF.02697

53 marron  
53 castanho

REF.02699



**Faux cils complets auto-adhésifs de couleur noire**  
**Pestanas completas auto adhesivas pretas cor preto**



u.m.vta: 4 72

33 noir  
 33 cor preto  
**REF.03670**



21 noir  
 21 cor preto  
**REF.03672**



45 noir  
 45 cor preto  
**REF.03673**



53 noir  
 53 cor preto  
**REF.03671**



**Faux cils complets**  
**Pestanas completas**

u.m.vta: 4 72

52 noir  
 52 cor preto  
  
**REF.04841**



33 marron  
 33 castanho  
  
**REF.04079**



80 noir  
 80 cor preto  
  
**REF.04842**



82 noir  
 82 cor preto  
  
**REF.04843**



19 noir  
 19 cor preto  
  
**REF.04844**



Mod Accents  
 318 noir  
 318 pretas "Accents"  
  
**REF.04846**



Mod . Accents  
 301 noir  
 301 pretas "Accents"  
  
**REF.04554**



Mod . Accents  
 305 noir  
 305 pretas "Accents"  
  
**REF.04555**



**Full lashlites 335 pestañas postizas en color negro**  
**Full lashlites 335 false eyelashes in black color**

u.m.vta: 4  72

REF.04845



**Kit de faux-cils andrea**  
**Kit pestanas andrea**

u.m.vta: 4  36

Starter 45  
Starter 45

REF.02704



Starter 53  
Starter 53

REF.02703



Starter 33  
Starter 33

REF.02702



**Faux-cils en touffes sans noeuds**  
**pestanas sem nós**

u.m.vta: 4  72

Largas  
Long



REF.04553



Moyens  
Médias



REF.04552



Curts  
Curto



REF.04551



Avant · Antes

Alors · Então





## Faux-Cils individuels Permalash

### Pestanas individuais PESTANAS Permalash

u.m.vta: 4	72
------------	----

Moyens, de couleur marron SM  
Médias, castanho SM



REF.02708



Combo de couleur noire  
Largas cor preto



REF.03278



Moyens, de couleur noire SM  
Cor preto, médias



REF.02707



Larges de couleur noire  
Largas cor preto



REF.04078



Petite taille et de couleur noire  
pequenas, cor preto SM



REF.02705



Petite taille et de couleur marron  
Pequenas, castanhas SM



REF.02706



Moyens poil à poil de couleur noire  
Médias pêlo a pêlo cor preto



REF.03277



Avec la technique poil à poil, de couleur noire  
Curtas pêlo a pêlo. Cor preto



REF.03276



## Kit de Cils individuels combo de couleur noire

### Kit pestanas individuais combo cor preto

u.m.vta: 4	36
------------	----

REF.04077



### Adhésif pour faux Cils INDIVIDUELS Adesivo Pestañas INDIVIDUAIS

Ne convient pas aux cils pleins  
Não é adequado para cílios cheios

u.m.vta: 6  72

- Andrea Permalash. Couleur claire: transparente
- Andrea Permalash. Claro: transparent

**REF.02713**

- Andrea Permalash. De couleur foncée
- Andrea Permalash Escuro

**REF.03066**

3,5 g



3,5 g



### Dissolvant d'adhésif à faux cils INDIVIDUELS Dissolvente adesivo pestanas INDIVIDUAIS

Ne convient pas aux cils pleins  
Não é adequado para cílios cheios

u.m.vta: 6  72

**REF.03204**

3,5 g



### Adhésif pour faux Cils COMPLETS Adesivo Pestañas COMPLETAS

Ne convient pas aux cils individuels  
Não é adequado para cílios individuais

u.m.vta: 6  72

- Andrea Permalash de couleur claire: Transparente
- Andrea Permalash claro: transparent

**REF.02711**

3,5 g



- Andrea Modlash oscuro
- Andrea Modlash dark

**REF.02712**

3,5 g





## Présentoir de faux Cils Andrea Expositor pestanas Andrea

u.m.vta: 1  1

REF.03203



Présentoir rotatif  
Expositor giratório

u.m.vta: 1  1

REF.03335



Présentoir rotatif  
Expositor giratório



Il contient 8 unités de chaque:

- Onglets complets: 02690, 02691, 02693, 02695, 02696, 02698, 02700, 02701.
- Cils complets adhésifs: 02711 (clair), 02712 (foncé)
- Cils individuels: 02705, 02706, 2707, 02708, 03278
- Onglets individuels adhésifs:
- 02713 (light), 03066 (dark)
- Cils individuels dissolvants adhésifs: 03204

Contém 8 unidades de cada:

- Abas completas: 02690, 02691, 02693, 02695, 02696, 02698, 02700, 02701.
- Pestanas cheias adesivas: 02711 (claro), 02712 (escuro)
- Cílios individuais: 02705, 02706, 2707, 02708, 03278
- Guias individuais adesivas:
- 02713 (claro), 03066 (escuro)
- Cílios individuais com solvente adesivo: 03204

Présentoir de faux Cils Andrea VIDE  
Expositor pestanas Andrea VAZIO

## Recourbe-cils Enrolador de pestanas

u.m.vta: 12  120

REF.01109

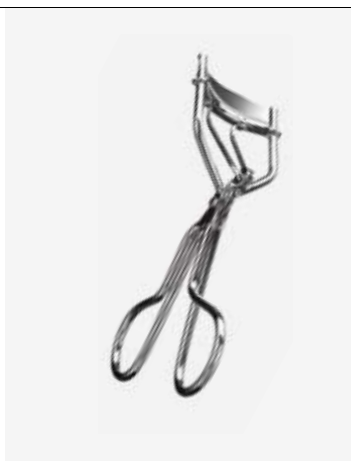

## Recourbe-cils en caoutchouc de rechange Recarga borracha modelador de pestanas

u.m.vta: 12  12



2 u

REF.01110



### 3 Rasoirs à sourcils pollié

### 3 Navalhas pollié para sobrancelhas

u.m.vta: 1	 12	
------------	--	---

Rasoir pour sourcils, duvet du visage et duvet du corps. Il est conseillé d'appliquer du gel ou de la crème sur la zone à raser pour que la coupe soit plus douce et agréable. Le manche est en ABS et la lame en acier inoxydable de haute qualité.

Lâmina para sobrancelhas, penugem facial e pelos corporais. É aconselhável aplicar gel ou creme na zona que se deseja barbear, para que seja um corte mais suave e cómodo. O cabo é fabricado em ABS, enquanto a folha é fabricada em aço inoxidável de elevada qualidade.

REF.07125



REF.07126



### Les sourcils andrea

### Sobrancelhas andrea

u.m.vta: 1	 24
------------	--

3 en 1 crème brune moyenne  
3 em 1 creme castanho médio

REF.06286



Powder duo brune moyenne  
Powder duo castanho médio

REF.06287



Powder duo brune foncé  
Powder duo castanho escuro

REF.06288



Pencil duo brune foncé  
Pencil duo castanho escuro

REF.06289



07



## Hygiène et jetables esthétique

### Acessorios e higiene

*Drap pour table de massage, serviettes,  
couvertures, miroirs, vêtement...*

*Capas marquesa, tolas, espelhos, malas..*

### Sac 10 housses ajustables pour table massage Bolsa 10 covers marquesa ajustável

u.m.vta: 1  10 

30 g

REF.07308

- Matériel: Nonwoven
- Dimensions: 210cm x 80 cm
- Bête 100 unités de couverture de civière réglable
- 1unité/sachet
- Poids: 30 g

- Material: Nonwoven
- Medidas: 210 cm x 80 cm
- Caixa de 100 unidades de maca ajustável
- Apresentado em bolsa individual
- Peso: 30 g



### Papier pour table massage Rolo papel marquesa

u.m.vta: 6  6 

REF. 00928

- Rouleau de papier pour table esthétique
- Longueur: 78m / largeur: 59 cm
- Poids du papier: 43g.
- 40 services marqués et prédécoupés, d'une longueur de 1,95 m chacun.

- Comp: 78m/largura:59 cm
- Gramagem do papel: 43g.
- 40 serviços marcados e pré-cortados, de 1,95 m de largura cada um.
- Os rolos estão embalados individualmente.



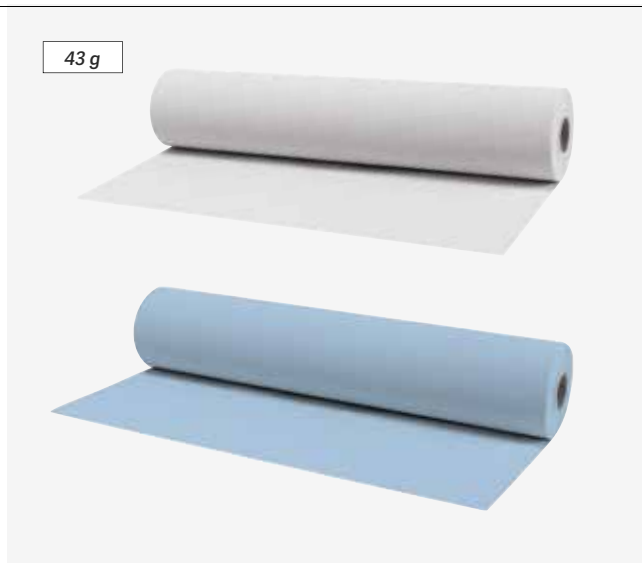

REF.00928/75

43 g



### Couverture pour table massage ajustable Cover marquesa ajustável

u.m.vta: 6  6 

REF. 03336

- Matériel: Nonwoven
- Dimensions: 210cm x 80 cm
- Bête 100 unités de couverture de civière réglable
- 1unité/sachet
- Poids: 40gr.

- Material: Nonwoven
- Medidas: 210 cm x 80 cm
- Caixa de 100 unidades de maca ajustável
- Apresentado em bolsa individual
- Peso: 40gr.

43 g



**Couverture chauffante pour table esthétique**  
**Manta elétrica para marquesa**

u.m.vta: 1  4

90 g

REF. 07791





**30 couvertures pour transpiration**  
**30 lençóis de transpiração**

u.m.vta: 1  10

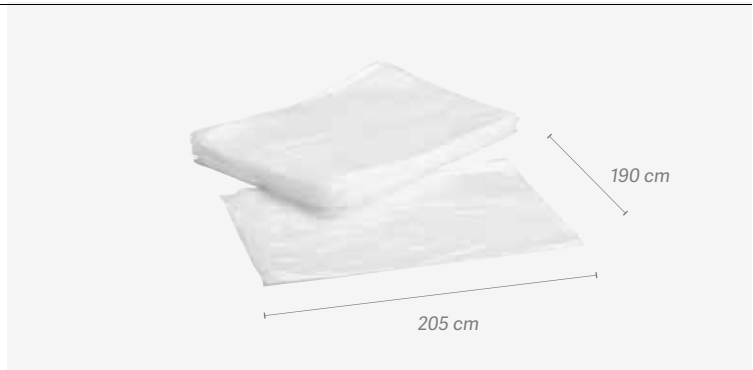
REF. 03912





**Housse stretcher blanc tergal**  
**Protecção elastica branca**

u.m.vta: 1  12 

REF. 06650





**Sachet 75 serviettes CELLULOSE****Pacote 75 toalhas CELULOSE**

u.m.vta: 1		16	
------------	---	----	---

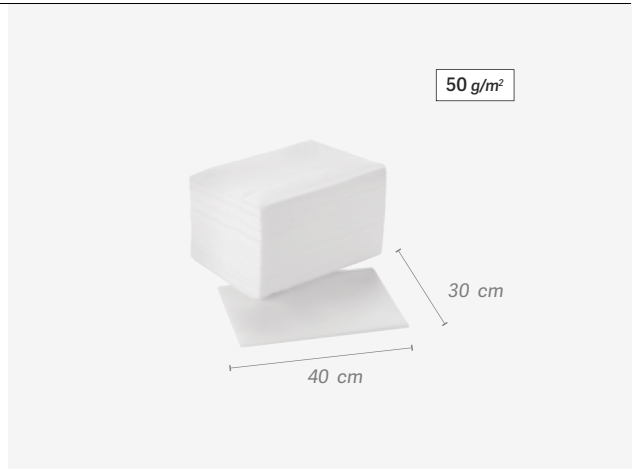
Spéciales manucure  
Especial manicure

**REF. 04204****Sachet 90 Serviettes CELLULOSE****Pacote 90 Toalhas CELULOSE**

u.m.vta: 4		144	
------------	---	-----	---

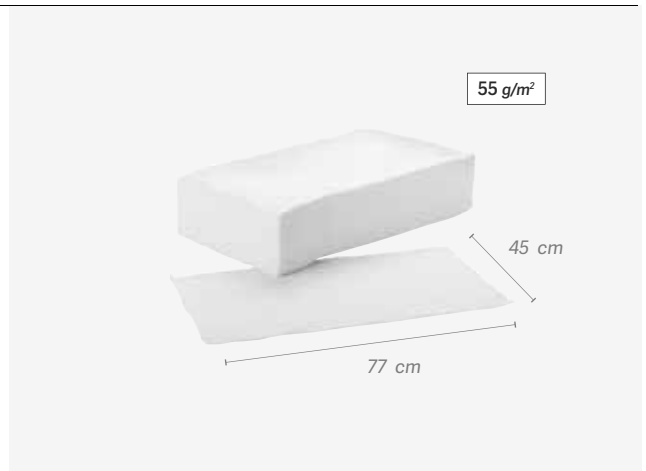
**REF.04076****Sachet de 35 serviettes SPUNLACE****Pacote 35 toalhas SPUNLACE**

u.m.vta: 1		12	
------------	---	----	---

50 g/m<sup>2</sup>**REF. 04509**



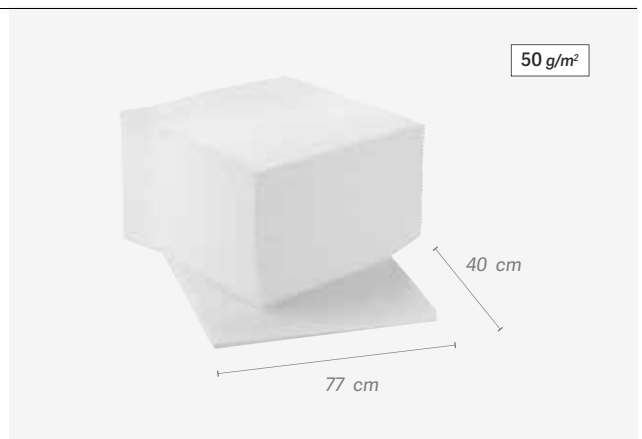

- Super absorbantes.
- Serviettes pliées

- Superabsorventes
- Toalhas dobradas.





**Sachet de 25 serviettes SPUNLANCE****Pacote 25 toalhas SPUNLANCE**

u.m.vta: 1	 24		u.m.vta: 1	 28	
------------	--	---	------------	--	---

50 g/m<sup>2</sup>

40 x 90 cm



**REF. 04916**50 g/m<sup>2</sup>

40 x 80 cm

**REF. 03221**

- Plié à 20 x 20 cm
- 50% Polyester / 50% viscose
- Dobrado a 20 x 20 cm
- 50% poliéster / 50% Viscose



50 g/m<sup>2</sup>**Sachet de 100 serviettes SPUNLACE****Bolsa 100 toalhas SPUNLACE**

u.m.vta: 1	 16	
------------	--	---

50 g/m<sup>2</sup>**REF. 07302**

- Composition : 50% viscose / 50% polyester
- Produit très résistant et absorbant, polyvalent, pratique et jetable.
- Entièrement fabriqué sans latex, toucher très doux

- Composição: 50% viscose/50% poliéster.
- Produto de grande resistência e absorção, versátil, prático e descartável
- Totalmente livre de látex, de tato muito suave

u.m.vta: 1	 32	
------------	--	---

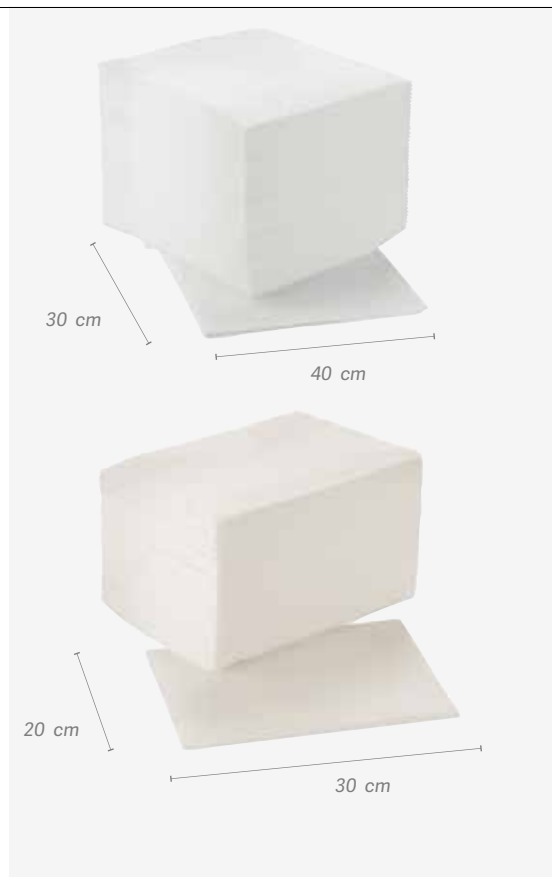
50 g/m<sup>2</sup>**REF. 07303**

30 cm



40 cm

20 cm

30 cm

### Sachet de 75 serviettes SPUNLACE

#### Bolsa 75 toalhas SPUNLACE

u.m.vta: 1  16 

**REF. 04510**

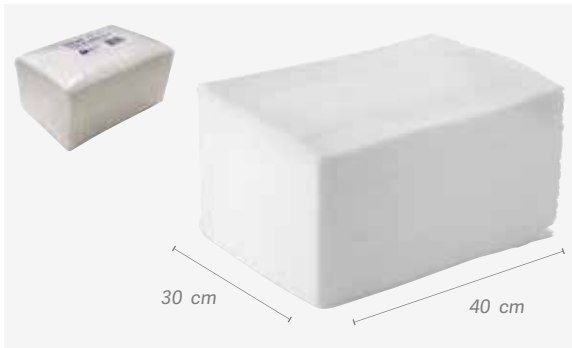

- Super absorbantes
- Serviettes pliées
- Manucure spéciale

- Superabsorventes
- Toalhas dobradas
- Especial manicure



### Sachet 100 Serviettes SPUNLACE

#### Pacote 100 toalhas SPUNLACE

u.m.vta: 1  20 

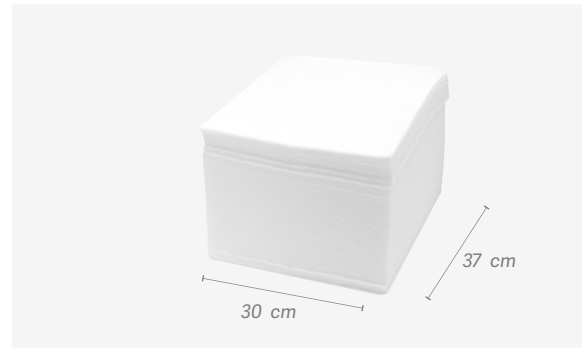

**REF. 03283**

- Super absorbantes
- Superabsorventes.



### Protecteurs - pantalons

#### Protetores - calças

u.m.vta: 1  10 

**REF. 06111**

Sachet contenant 25 unités de pantalons de protection en polyéthylène de haute densité pour des traitements esthétiques tels que la pressothérapie ou des traitements en cabine avec des algues ou des boues.

*Bolsa 25 unidades calças protetoras polietileno de alta densidade para tratamentos estéticos como pressoterapia ou tratamentos em cabine com algas ou lamas.*



### 100 Gants en polyéthylène transparent

#### 100 Luvas transparentes de polietileno

u.m.vta: 100  100



**REF. 07804**

- 100% Polyéthylène vierge pehd 0,7 +/- 2% g / pc
- Hypoallergénique, étanche, taille unique
- EPI catégorie 1
- Fabriqué et marqué CE, compatible avec l'usage alimentaire 2011/10 / CE
- 30 Cm. Hauteur x 25 cm. Largeur des doigts x 15 cm. Largeur du poignet

- Polietileno hdpe 100% 0,7 +/- 2% g / pc
- Analérgico, impermeável, um tamanho,
- Categoria 1 EPI
- Produtos e marcações CE, compatível com uso de alimentos 2011/10 / CE
- 30 Cm de altura x 25 cm de largura x 15 largura do pulso 15



### Boîte 100 gants jetables 100 luvas descartáveis

u.m.vta: 1  25 

80 g

REF. 07257

- Gants ambidextres, qui servent pour les deux mains
- Taille unique
- Multi-usages

- *Ambidestro permite que cada luva seja usada para qualquer mão*
- *Tamanho único*
- *Multiuso*



### Boîte 100 gants jetables 100 Luvas pe descartáveis

u.m.vta: 1  1



REF.00680

Matériel : plastique polyéthylène  
LDPE basse pression  
Caractéristiques : lisse, incolore  
Taille : grand ambidextre

*Material: plástico de polietileno  
LDPE de baixa pressão  
Características: liso, incolor  
Tamanho: grande ambidestro*



### Sachet de 100 gants jetables Saco de 100 luvas descartáveis

u.m.vta: 1  100 

REF. 07304



### Sachet de 2 unités. Gants professionnels Bolsa 2 u. luvas profissionais

u.m.vta: 1  24

- Matériel: caoutchouc
- *Material: rubber*

6,5

Talla /Tamanho

REF.01672

7

Talla /Tamanho

REF.01673

7,5

Talla /Tamanho

REF.01674

8

Talla /Tamanho

REF.01675



**Boîte 50 gants synthétiques**  
**Caixa 50 luvas látex pretas**

PAS de poussière  
SEM pó

u.m.vta: 1  20 

L

REF. 07264

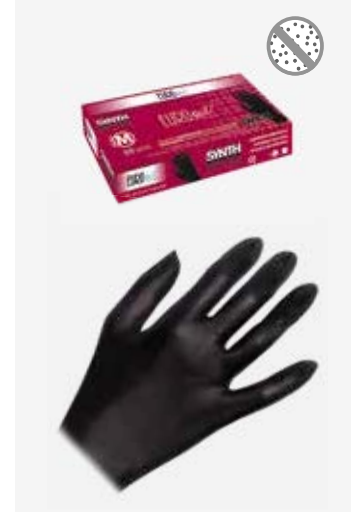

- Combinent la flexibilité du latex et l'élasticité du vinyle inodore.
- Sensation de seconde peau grâce aux propriétés élastiques très similaires au latex et aux propriétés hypoallergéniques du vinyle.
- Matière : dérivé du PVC.
- Non stériles.
- Couleur noire.
- Surfaces interne et externe lisses
- Aptes pour allergiques au latex

- Combina a flexibilidade do látex e a elasticidade do vinil inodoro
- Segunda sensação na pele graças às suas propriedades elásticas muito semelhantes ao látex e oferece as propriedades hipoalergênicas do vinil.
- Material: derivado de PVC.
- Não estéril
- Cor preta
- Superfícies lisas internas e externas
- Adequado para pessoas alérgicas ao látex



**Boîte contenant 100 gants blancs en latex légèrement poudrés**  
**Caixa 100 luvas látex brancas com pouco pó**

PAS de poussière  
SEM pó

u.m.vta: 1  10 

S

REF. 01671

M

REF. 01669

L



REF. 01670



LATEX / LATEX  
AQL 1,5

**Boîte contenant 20 gants noirs en latex**  
**Caixa 20 luvas látex pretas**

PAS de poussière  
SEM pó

u.m.vta: 1  24 

S

REF. 02832

M

REF. 02833

L



REF. 02834



LATEX / LATEX  
AQL 1,5

**Boîte contenant 100 gants vinyle**  
**Caixa 100 luvas vinil**

PAS de poussière  
SEM pó

u.m.vta: 1  10 

S

REF. 02586

M

REF. 02587



VINYLE / VINYL  
AQL 1,5



**Pince en acier inoxydable**  
**Aço inoxidável, utensílios de uso geral**

u.m.vta: 1  12

**REF.04556**



**Serviette 100% coton**  
**Toalha 100% algodão**

u.m.vta: 12  48 

 **REF. 02947/58**

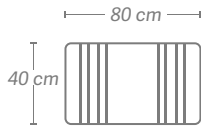

 **REF. 02901/58**

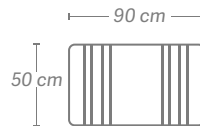

**Serviette de manucure**  
**Toalha manicure**

u.m.vta: 12  48

**REF.00974**

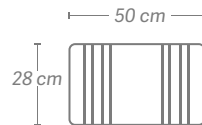



**Serviette 100% coton**  
**Toalha 100% algodão**

u.m.vta: 1  12

380 g/m<sup>2</sup>

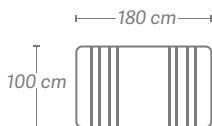
**REF. 06570/58**



u.m.vta: 1  12

380 g/m<sup>2</sup>

**REF. 06571/58**

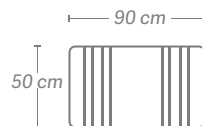



**Brosse tout usage, couleurs**  
**Escova multi-usos, cores**

u.m.vta: 24  24

**REF. 00129**



**Brosse vêtements et ski**  
**Escova roupa e tapeçaria**



u.m.vta: 1  20 

**REF.00893**

Caoutchouc bleue  
 Borracha azul



## Draps de protection Lençóis protetores



u.m.vta: 1  16 

REF. 06112



Polyéthylène haute densité 25 unités.  
180 x 200 cm. Pour les traitements d'algues et de boue.

Polietileno de alta densidade 25 unidades.  
180 x 200 cm. Para tratamentos de algas e lama

u.m.vta: 1  10 



REF. 06110



Draps de protection polyéthylène haute densité 50 unités.  
180 x 200 cm. Pour les traitements d'algues et de boue.

Lençóis protetores polietileno de alta densidade 50 unidades.  
180 x 200 cm. Para tratamentos de algas e lama

## Balance spa mesure l'hydratation et le % de graisse corporelle Balança spa mede a hidratação e a % de gordura corporal

u.m.vta: 1  6 



REF. 04805

- Capacité: 150 kg
- Échelle: 6 à 150 kg
- Unité de pondération: kg / lb / st
- Deux piles CR2032 (Incluses)
- Vitesse de pesée: vitesse moyenne (env. deux secondes)
- Arrêt automatique: 10 secondes
- Lorsque la pile est faible, l'écran affiche « LO »

- Capacidade: 150 kg
- Escala: 6 a 150 kg
- Unidade de ponderação: kg / lb / st
- Duas pilhas CR2032 (Incluídas)
- Velocidade de pesagem: velocidade média (aprox. dois segundos)
- Desliga automaticamente: 10 segundos
- Quando estiver a ficar sem pilhas marcará no ecrã "LO".



## Sac de 50 tapis pour solarium Bolsa 50 tapetes solarium

u.m.vta: 1  20 

REF.03803





### Sachet de Kimonos jetables

#### Saco de 10 Kimonos descartáveis

u.m.vta: 1  10 



28 g

REF. 07307/58



28 g

REF. 07307/50



- Dimensions : 110x140 cm.
- Matière : tissu non tissé
- La ceinture se trouve dans une poche du bras gauche
- Sachet de 10 unités

- Medidas: 110 x 140 cm.
- Material: non woven (tecido sem tecer)
- Leva o cinto num bolso do braço esquerdo
- Saco de 10 unidades

### Sac 100 couvre-chaussures

#### Embalagem 100 cobre-sapatos

u.m.vta: 1  50

REF.07211

- À usage unique
- Plastique
- Uma só utilização
- Plástico
- Fermées
- jetable
- Fechadas
- Utilização única



**Sac de 100 paires de pantoufles avec semelle en caoutchouc**  
**Bolsa de 100 pars des Sapatilhas sola borracha**

u.m.vta: 100  100

Ouverte  
Abertas

**REF.02919**



Fermées  
Fechadas

**REF.02920**



**Sac de 50 paires de pantoufles**  
**Bolsa de 50 pars des Sapatilhas**

u.m.vta: 1  10



**REF.03807**



**REF.03808**



**Paire de deux claquettes pédicure**  
**Par de dois chinelos de pedicure**



u.m.vta: 1  12 

**REF. 06776**

- Couleurs variées
- Sortido cores





**Sachet de 12 paires de claquettes pédicure**  
**Bolsa com 12 pares de chinelos de pedicure**

u.m.vta: 1  40 

**REF. 07432**



**Sachet de 100 charlottes**  
**Bolsa 100 coifas**



u.m.vta: 1  10 

10 g

**REF.07305**

- Jetable
- Pliés de type accordéon
- Utilização única
- Pregadas tipo acordeão

**Boîte de 100 bandeaux blancs**  
**Caixa 100 diademas brancas**

u.m.vta: 1  10 

**REF.07306**

- Jetable
- Utilização única



**Rouleau de papier crêpé**  
**Rolo papel crepado**



u.m.vta: 5  100

**REF.04420**



- Pour bandeaux
- 100 services
- Spécial esthétique.
- Para diademas
- 100 utilizações
- Especial estética



**Boîte de 50 strings pour homme****Bolsa 50 tangas homem**u.m.vta: 1  20 **REF.03216**

- Jetable. Une taille unique
- Élastique et ajustable
- Couleur noire opaque
- Idéal comme complément pour l'épilation et le traitement
- Utilização única. Tamanho único
- Elástico para adaptar-se a qualquer medida
- Cor preto opaco
- Ideal como complemento para depilação e tratamento

**Boîte de 50 slips pour homme****Bolsa 50 slips homem**u.m.vta: 1  10**REF.03295**

- Jetable. Une taille unique
- Élastique et ajustable
- Couleur noire opaque
- Idéal comme complément pour l'épilation et le traitement
- Utilização única. Tamanho único
- Elástico para adaptar-se a qualquer medida
- Cor preto opaco
- Ideal como complemento para depilação e tratamento

**Boîte de 10 boxers pour homme****Bolsa 10 boxers homem**u.m.vta: 1  4**REF.03802**

- Jetable
- Utilização única

**Boîte de 100 strings pour femme****Bolsa 100 tangas mulher**u.m.vta: 1  12**REF.03483**



- Élastique ajustable.
- Jetable
- Large bande
- Elástico para adaptar-se a qualquer medida.
- Utilização única
- Alça larga

**Boîte de 100 strings pour femme****Bolsa 100 tangas mulherstrings**u.m.vta: 1  12**REF.01091**

- Bande arrière très étroite.
- Jetable
- Tira traseira muito estreita.
- Utilização única



### Pantalons pressothérapie Calças pressoterapia

u.m.vta: 1  100 

REF.03694



- Sans élastique
  - Blanc.
  - Jetable
- Sem elástico
  - Branco.
  - Utilização única

### Bandeau esthétique Diadema esteticien

u.m.vta: 10  100

REF. 01088



### Tee shirt TASSEL Camiseta TASSEL

u.m.vta: 1  50

M

REF.06284/2

L

REF.06284/3

XL

REF.06284/4

XXL

REF.06284/5



Chemises pour femmes en coton. Noir, col rond et manches courtes avec logo Tassel sérigraphié sur la poitrine. Disponible en plusieurs tailles. Confortable, facile à combiner avec n'importe quel look. Tissu résistant

Camisas femininas em algodão. Preto, gola redonda e mangas curtas com o logotipo Tassel serigrafado no peito. Disponível em vários tamanhos. Confortável, fácil de combinar com qualquer look. Tecido resistente

### Lunettes de protection antibuée

#### Tapete desinfetante de calçado

u.m.vta: 1		10
------------	---	----

REF.07256



- Protection pour prévenir les infections elles protègent efficacement des éclaboussures, des poussières, etc...
- Lieu d'utilisation : tous les endroits qui nécessitent une protection des yeux.
- Design innovant, confortable. Elles s'ajustent parfaitement à toute les formes et tailles de tête.
- Elles peuvent être utilisées en même temps que des lunettes de vue.
- Certificat CE
- Matière : plastique

- *Proteção para prevenir infeções: protegem eficazmente contra salpicos, cascalho, etc.*
- *Local de utilização: qualquer lugar onde se requiera proteção para os olhos.*
- *Design inovador cómodo. Ajustam-se perfeitamente a qualquer forma e tamanho de cabeça.*
- *Podem-se utilizar por cima dos seus óculos graduados.*
- *Certificado CE*
- *Material: plástico*

### Tapis désinfection pour semelles de chaussures

#### Tapete desinfetante de calçado

u.m.vta: 1		12
------------	---	----

REF.07234



Tapis extra-plat de seulement 1 cm de hauteur pour éviter les chutes, fabriqué en polypropylène sur une base en caoutchouc et un conteneur en aluminium ionisé. Dimensions : 60 cm de largeur x 40 cm de longueur x 1 cm d'épaisseur/hauteur.

*Tapete extraplano com apenas 1 cm de altura para evitar que alguém tropece em polipropileno sobre uma base de borracha e contendor de alumínio oxidado. Medidas: 60 cm largura x 40 cm profundidade x 1 cm altura/espessura*

Mode d'emploi : placer le tapis sur une surface plane et nivelée, appliquer dans le plateau environ 700 ml de liquide désinfectant. Il est recommandé de placer un paillasson après le plateau pour que le client puisse ensuite s'essuyer les pieds.

*Como utilizar: colocar o tapete sobre uma superfície plana e nivelada aplicar na bandeja cerca de 700 ml de líquido desinfetante. Aconselhamos colocar um tapete fofinho à frente deste tapete para secar o calçado do cliente.*

### Boîte 200 coton-tige coton avec TIGE EN PAPIER

#### Caixa 200 cotonetes algodão com PAUZINHO DE PAPEL

u.m.vta: 1		24
------------	---	----

REF.07261



### Sachet de coton zigzag pré-découpé

#### Bolsa algodão zigzag pré-cortado

u.m.vta: 20		20
-------------	---	----









REF.02949





**Kg coton de coiffure en rouleaux. 9 Morceaux de 3,5 cm (embouts inclus)**  
**Kg algodão cabeleirero em rolos. 9 Cortes de 3,5 cm (pontas incluídas)**

Bouts inclus  
Pontas incluídas

u.m.vta: 1	 12		u.m.vta: 1	 12		u.m.vta: 1	 12		u.m.vta: 1	 10	
------------	--	---	------------	--	---	------------	--	---	------------	--	---

REF. 00964

Anónimo  
Anonymous

REF. 00964/00

4 coupures de 8 cm  
4 cortes de 8 cm



REF. 04290

Plié  
Dobrável

REF. 04288





**Sachet de disques pour démaquiller**  
**Bolsa discos desmaquiagem**

u.m.vta: 24	 24	
-------------	--	---

80 disques  
80 discos

REF. 07118





u.m.vta: 1	 24	
------------	--	---

Anónimo  
Anonymous

REF. 07118/00





**Miroir chromé rond**  
**Espelho cromado redondo**

u.m.vta: 1  60  Ø 10 cm

5x	7x	10x
REF.06716	REF.06717	REF.06718

u.m.vta: 1  24  Ø 15 cm





5x	7x	10x
REF.06719	REF.06720	REF.06721

u.m.vta: 1  24  Ø 18 cm



5x	7x	10x
REF.06722	REF.06723	REF.06724



**Miroir chromé rond avec 3 ventouses**  
**Espelho cromado redondo com 3 ventosas**

u.m.vta: 1  48  Ø 15 cm      u.m.vta: 1  24 





5x	7x	10x
REF.06725	REF.06726	REF.06727

u.m.vta: 1  24  Ø 21 cm

5x	7x	10x
REF.06728	REF.06729	REF.06730







### Miroir chromé rond avec support Espelho cromado redondo com base

u.m.vta: 1	 12		u.m.vta: 1	 6	
Ø 15 cm			Ø 21 cm		
<input type="text" value="7x"/>		<input type="text" value="10x"/>		<input type="text" value="10x"/>	
REF.06731		REF.06732		REF.06735	
				REF.06736	







### Miroir bleui avec socle Espelho azulado com base

u.m.vta: 1	 12		u.m.vta: 1	 6	
Ø 15 cm			Ø 21 cm		
<input type="text" value="7x"/>		<input type="text" value="10x"/>		<input type="text" value="10x"/>	
REF.06733		REF.06734		REF.06737	
				REF.06738	



### Miroir chromé rond avec pieds et support Espelho cromado redondo com pé e base

u.m.vta: 1	 12		u.m.vta: 1	 6	
Ø 15 cm			Ø 21 cm		
<input type="text" value="7x"/>		<input type="text" value="10x"/>		<input type="text" value="10x"/>	
REF.06739		REF.06740		REF.06741	
				REF.06742	



**Miroir double face pivotant rond sur un pied en métal grossissant 5X / normal**  
**Espelho pé metálico duplo 5 aumentos/normal**

Produit amélioré - Nouvel emballage  
 Produto melhorado - Nova embalagem

u.m.vta: 1  6

5x  
**REF.02801**



5x  
**REF.02806**



Produit amélioré - Nouvel emballage  
 Produto melhorado - Nova embalagem

u.m.vta: 1  12



5x  
**REF.02799**



5x  
**REF.02800**



### Miroir à double face Espelho duplo



u.m.vta: 1  24 

Avec poignée et support  
Com cabo e suporte

**REF. 01965**



### Miroir rond Espelho redondo

u.m.vta: 1  8 

Miroir rond professionnel  
Espelho redondo profissional

**REF. 00294/56**

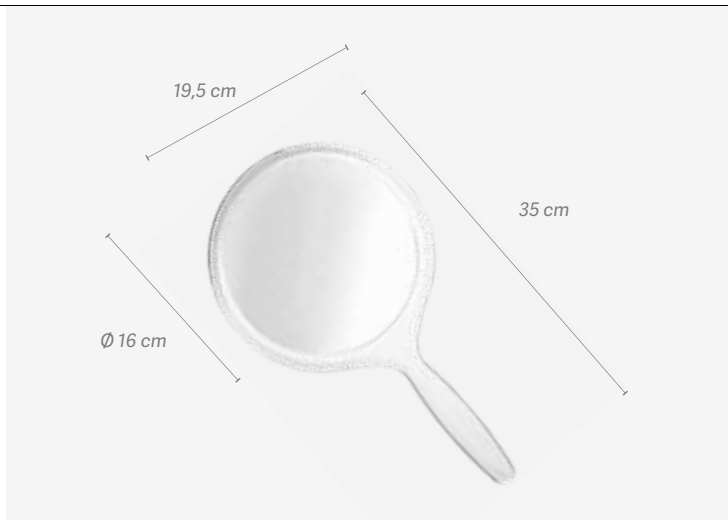



### Miroir Mousse Eva Espelho espuma EVA

u.m.vta: 1  24

**REF.04742**





**Miroirs**  
**Espelhos**

u.m.vta: 1		75	
------------	---	----	---

Modèle Capilla  
Modelo Capilla

**REF. 00265**

u.m.vta: 1		75	
------------	---	----	---



Carré  
Quadrado

**REF. 00268**

u.m.vta: 1		80	
------------	---	----	--



Avec poignée  
Com pega

**REF.00250**

u.m.vta: 1		30	
------------	---	----	---

**REF. 00266**

- Miroir rond normal / augmentation
- Espelho redondo normal/aumento

u.m.vta: 1		125	
------------	---	-----	---



**REF. 03073**

- Miroir poudrier normal / augmentation avec un peigne
- Espelho pó normal/aumento com pente







**Miroir rond**  
**Espelho redondo**

u.m.vta: 1  100 

S

REF. 00263

**Miroir rond**  
**Espelho redondo**

u.m.vta: 1  12 

NORMAL/X2 S

REF. 06620

NORMAL/X2 M

REF. 06621

NORMAL/X2 L

REF. 06622

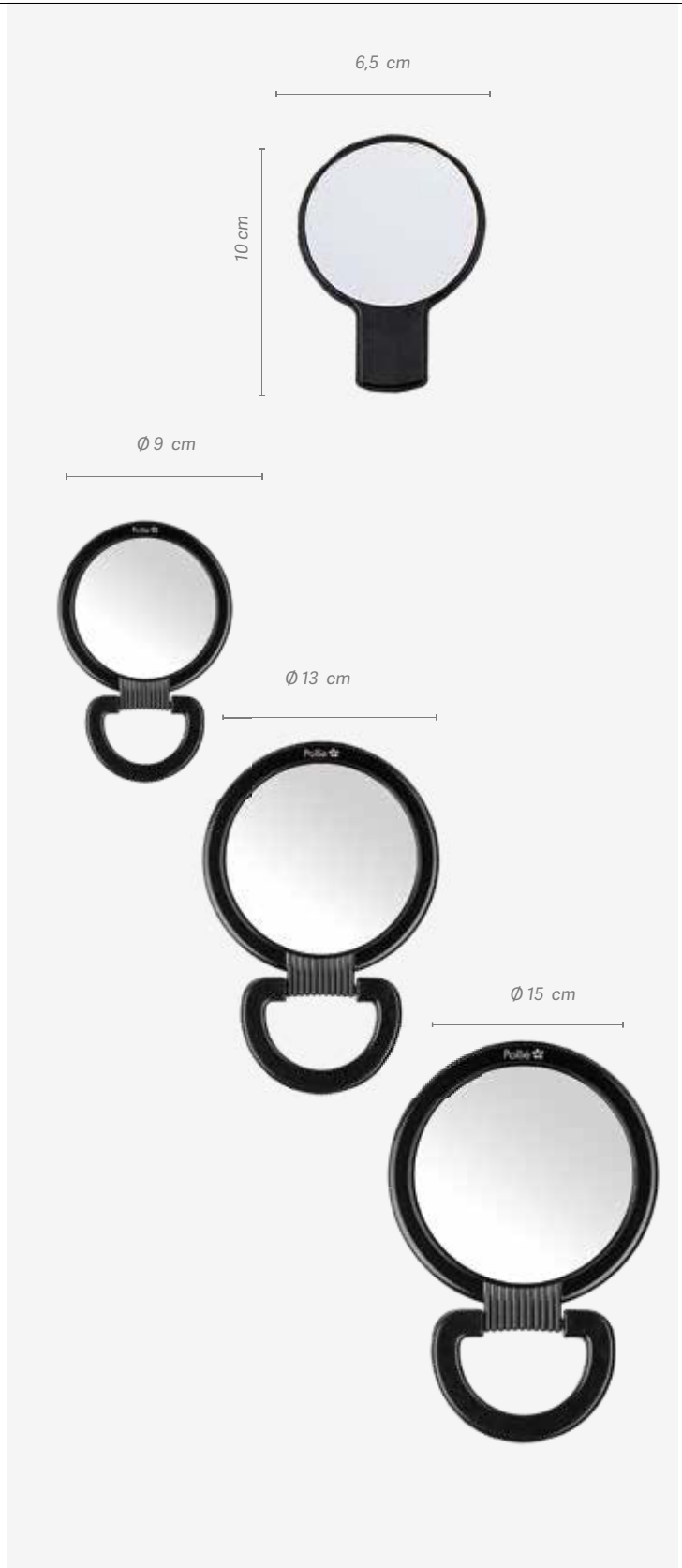

**Miroir de camping**  
**Espelho de camping**

u.m.vta: 1  12

**REF.00275**

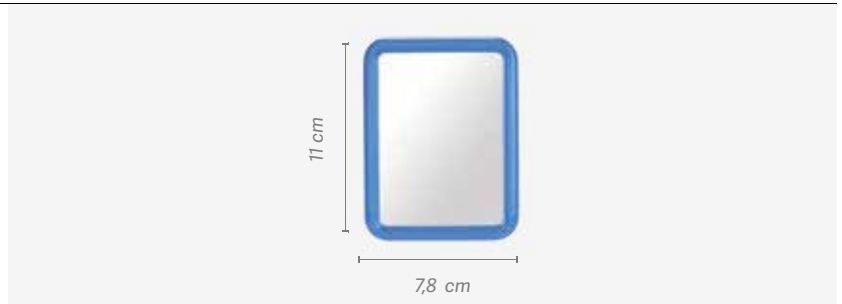

u.m.vta: 12  12

**S**

**REF.00256**

**M**



**REF.00257**

**L**

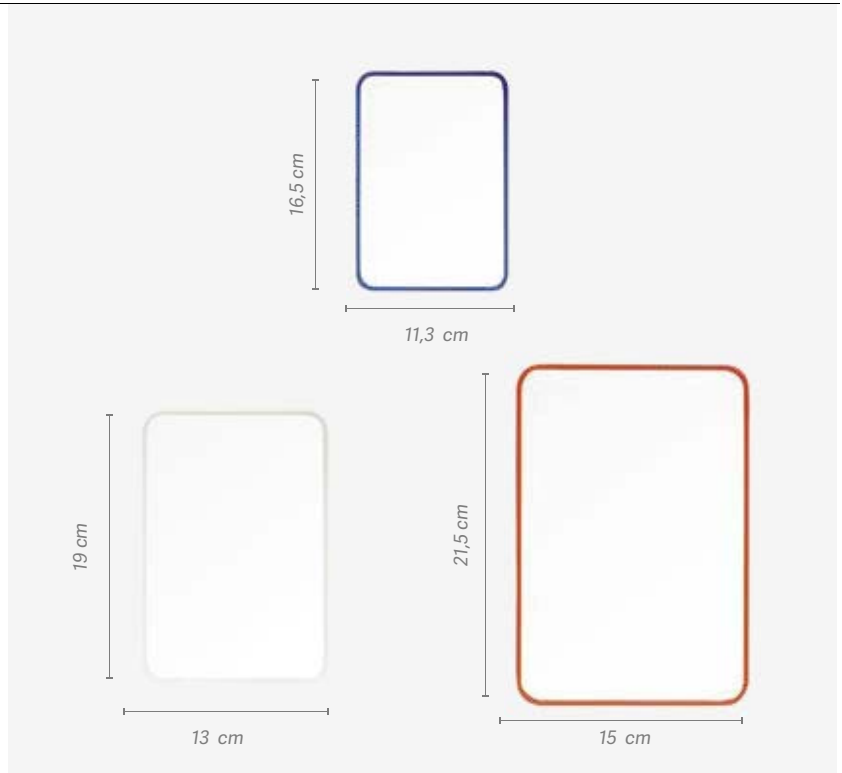
**REF.00258**



**Miroir TV**  
**Espelho TV**

u.m.vta: 1  10 



**REF. 00254/50**

 **REF. 00254/58**

 **REF. 00255**



**Boîte de 50 masques faciaux hygiéniques**  
**Caixa de 50 máscaras faciais higiênicas**

u.m.vta: 1  1 

**REF. 07383**



**Masque hygiénique 100% COTON ECOLOGIQUE 30 utilisations réutilisable /lavable**  
**Máscara higiênica 100% ALGODÃO ECOLÓGICO 30 utilizações reutilizável / lavável**



u.m.vta: 1  36

**REF. 07803**

- 30 utilisations
- LAVABLE: Laver à 60°, sécher et repasser à 140° durant 10-15 secondes pour activer le traitement. Nombre de lavages : 30)
- 30 utilizações
- LAVÁVEL: Lavar a 60°, secar e engomar a 140° durante 10-15 segundos para ativar o tratamento. (N.º de lavagens 30)



**Écran de protection visage**  
**Ecrã protetor facial**

u.m.vta: 12  120 

**REF. 07212**

**ANTIBUÉE**  
 Plastique transparent avec mousse sur le front pour un meilleur confort

**ANTI VAPOR**  
 Plástico transparente com espuma à frente para uma maior comodidade

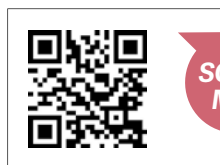
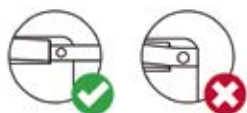

**SCAN ME!**



<p><b>Masque réutilisable</b> <b>60 lavages</b></p> <p><b>Máscara reutilizável</b> <b>60 lavagens</b></p>	<ul style="list-style-type: none"> <li>• Réutilisables</li> <li>• Certifiés</li> <li>• Waterproof</li> <li>• Transpirables</li> <li>• Microfibre</li> <li>• Équivalence FFP-2</li> <li>• LACLA Fabriqué en Espagne</li> </ul>	<ul style="list-style-type: none"> <li>• Reutilizáveis</li> <li>• Certificadas</li> <li>• Waterproof</li> <li>• Respirável</li> <li>• Microfibras</li> <li>• Equivalência FFP-2</li> <li>• LACLA Made in Spain</li> </ul>
---	---	---

**Pack 6 masques tissu unis**  
**Packs 6 máscaras têxteis unidades lisas**

u.m.vta: 1 20

- |                   |                   |                   |
|-------------------|-------------------|-------------------|
| Rose<br>Rosa      | Beige<br>Bege     | Blanc<br>Branco   |
| <b>REF. 07310</b> | <b>REF. 07318</b> | <b>REF. 07319</b> |



**Pack 3 masques tissu imprimés**  
**Packs 3 máscaras têxteis unidades estampadas**

u.m.vta: 1 40

- |                           |                   |                      |
|---------------------------|-------------------|----------------------|
| Papillons<br>Borboletas   | Cœurs<br>Coração  |                      |
| <b>REF. 07311</b>         | <b>REF. 07312</b> |                      |
| Têtes de mort<br>Caveiras | Pois<br>Bolinhas  | Militaire<br>Militar |
| <b>REF. 07315</b>         | <b>REF. 07314</b> | <b>REF. 07313</b>    |



## Casaque de coeurs

### Casaco de copas

\* Não disponível em Portugal

u.m.vta: 1 40

Noir  
Preta

MOD. 51605128

Casaque à manches courtes, avec pince poitrine et col mao, 1 poche frontale imprimée et une poche colour unie, boutons de couleur, cintrée, fentes latérales.  
100 % polyester

Mini jaqueta de manga, com gola de peito e gola mao, 1 bolso frontal com padrão 1 e um simples, abotoado com botões coloridos, equipado com pinças, fendas laterais.  
100 % poliéster

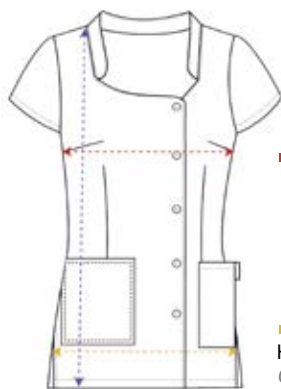
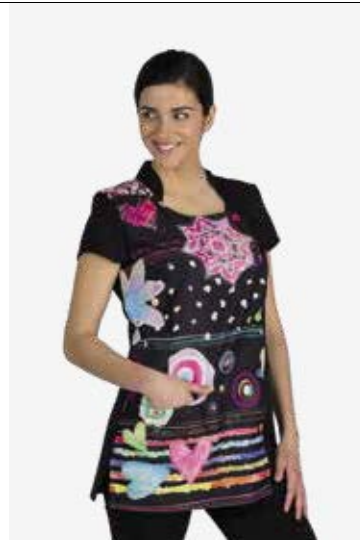
Coffre  
PeitoHanche  
QuadrilLongueur  
Longo

S	M	L	XL	XXL
98 - 102 cm	106 - 110 cm	114 - 118 cm	120 - 124 cm	126 - 130 cm
102 - 106 cm	108 - 112 cm	116 - 120 cm	124 - 128 cm	136 - 140 cm
72 - 74 cm	73 - 75 cm	75 - 77 cm	77 - 79 cm	78 - 80 cm

REF.06297/50/1

REF.06297/50/2

REF.06297/50/3

REF.06297/50/4

REF.06297/50/5

Blanc  
Branco

MOD. 51605128

Casaque à manches courtes, avec pince poitrine et col mao, 1 poche frontale imprimée et une poche colour unie, boutons de couleur, cintrée, fentes latérales.  
100 % polyester

Mini jaqueta de manga, com gola de peito e gola mao, 1 bolso frontal com padrão 1 e um simples, abotoado com botões coloridos, equipado com pinças, fendas laterais.  
100 % poliéster

Coffre  
PeitoHanche  
QuadrilLongueur  
Longo

S	M	L	XL	XXL
98 - 102 cm	106 - 110 cm	114 - 118 cm	120 - 124 cm	126 - 130 cm
102 - 106 cm	108 - 112 cm	116 - 120 cm	124 - 128 cm	136 - 140 cm
72 - 74 cm	73 - 75 cm	75 - 77 cm	77 - 79 cm	78 - 80 cm

REF.06297/58/1

REF.06297/58/2

REF.06297/58/3

REF.06297/58/4

REF.06297/58/5

**Casaque "live silver"****Casaco live silver**

\* Não disponível em Portugal

**lacla**u.m.vta: 1  40**Blanc**  
Branco**MOD. 52105640**

Casaque couleur unie, manches courtes, col mao, ourlet devant couleur argent satiné, avec poches, fermeture latérale avec des crochets métalliques rectangulaires, dos cintré, ouvertures latérales. Facile à repasser Polyester très respirant. 100 % polyester fin

*Casaco liso, mangas curtas, gola mao e bainha frontal com cor prateada acetinada, frente com ourelas e bolsos, fecho lateral com braçadeiras retangulares de metal, costas com grampos, aberturas laterais. Fácil de passar Poliéster muito respirável. 100 % poliéster fino*

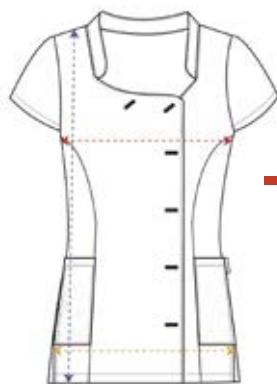
Coffre  
PeitoHanche  
QuadrilLongueur  
Longo**S**

98 - 102 cm  
104 - 108 cm  
70 - 72 cm

REF.07552/58/1

**M**

106 - 110 cm  
112 - 114 cm  
70 - 72 cm

REF.07552/58/2

**L**

114 - 118 cm  
118 - 122 cm  
72 - 74 cm

REF.07552/58/3

**MOD. 52105640****Noir**  
Preta

Casaque couleur unie, manches courtes, col mao, ourlet devant couleur argent satiné, avec poches, fermeture latérale avec des crochets métalliques rectangulaires, dos cintré, ouvertures latérales. Facile à repasser Polyester très respirant. 100 % polyester fin

*Casaco liso, mangas curtas, gola mao e bainha frontal com cor prateada acetinada, frente com ourelas e bolsos, fecho lateral com braçadeiras retangulares de metal, costas com grampos, aberturas laterais. Fácil de passar Poliéster muito respirável. 100 % poliéster fino*

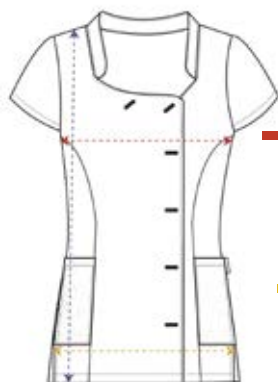
Coffre  
PeitoHanche  
QuadrilLongueur  
Longo**S**

98 - 102 cm  
104 - 108 cm  
70 - 72 cm

REF.07552/50/1

**M**

106 - 110 cm  
112 - 114 cm  
70 - 72 cm

REF.07552/50/2

**L**

114 - 118 cm  
118 - 122 cm  
72 - 74 cm

REF.07552/50/3

**XL**

120 - 124 cm  
126 - 130 cm  
73 - 75 cm

REF.07552/50/4





## Casaque bouddha

### Casaco buddha

u.m.vta: 1  40

\* Não disponível em Portugal



#### MOD. 51605109

Casaque à manches japonaises des couleurs vives, col mao, 1 face imprimée attachée avec boutons laqués, 1 poche couleur unie. Dos cintré avec lacets pour ajuster, ouvertures latérales. Repassage facile. Polyester respirant. 100 % polyester.

Casaco de manga japonesa com tom vívido, com clip no peito, colarinho mao, 1 frente estampada com fechos lacados, 1 bolso liso. Voltar com braçadeiras de volta com camadas para cintura regular, aberturas laterais. Fácil de passar Poliéster respirável. 100 % poliéster

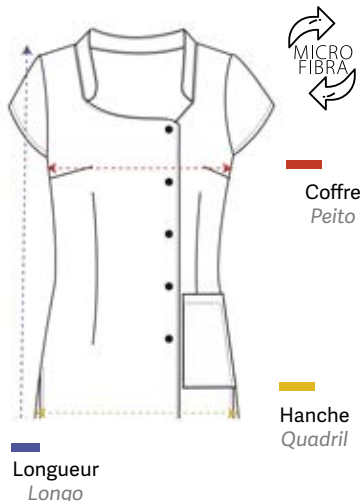

S	M	L	XL	XXL
94 - 98 cm	94 - 98 cm	106 - 110 cm	116 - 120 cm	118 - 122 cm
102 - 106 cm	102 - 106 cm	116 - 120 cm	124 - 128 cm	130 - 134 cm
71 - 73 cm	71 - 73 cm	75 - 77 cm	77 - 79 cm	75 - 77 cm
REF.06300/50/1	REF.06300/50/2	REF.06300/50/3	REF.06300/50/4	REF.06300/50/5

## Kimono antistatique

### Quimono antiático

u.m.vta: 1  40

#### MOD. 21300013

#### REF.06302/50



123 cm  
123 cm  
104 - 106 cm

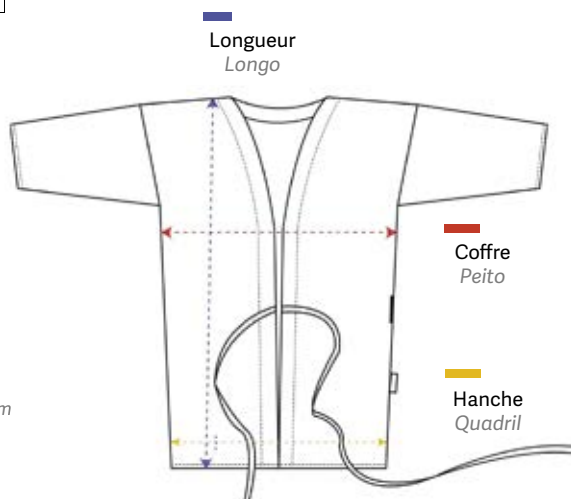

Kimono croisé avec ceinture, manche avec mini poche sur la manche. Facilé à repasser. Ne déteint pas. 100% polyester marocain.

Quimono cruzado com cinto, 3/4 de controle com mini bolso na manga. Fácil de passar. 100% poliéster marroquino

## Casaque fermeture éclair

### Casaco basic zipper

u.m.vta: 1 40

\* Não disponível em Portugal

MOD. 51308410

Noir  
Preta

Casaque sans manches. Fermeture éclair sur le côté. Composition 100% polyester. Deux poches, une à la taille et une sur la poitrine. Recommandée pour les magasins et salons de beauté.

Casaco básico sem mangas. Fecho de correr ao lado. Composição 100% poliéster. Dois bolsos, um na cintura e outro no peito. Recomendado para lojas e centros de beleza.

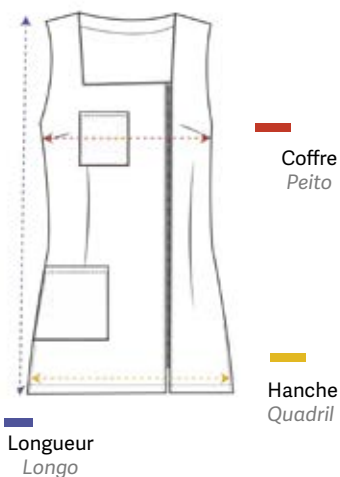

S

88 - 92 cm  
100 - 104 cm  
69 - 71 cm

REF.06298/50/1

M

94 - 98 cm  
104 - 108 cm  
71 - 73 cm

REF.06298/50/2

L

102 - 106 cm  
110 - 114 cm  
73 - 75 cm

REF.06298/50/3

XL

108 - 112 cm  
120 - 124 cm  
74 - 76 cm

REF.06298/50/4

XXL

116 - 120 cm  
128 - 132 cm  
76 - 78 cm

REF.06298/50/5

## Étole 100% polyester stretch

### Estola 100% poliéster stretch

u.m.vta: 1 40

MOD. 213014601

REF.06553/58

36 cm  
51 cm  
78 cm

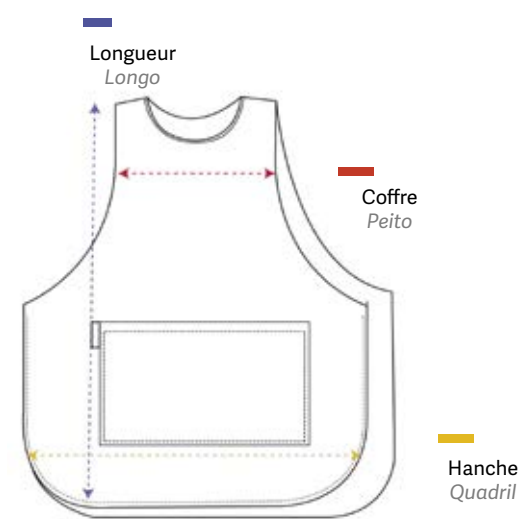

Étole 100% Polyester Stretch. Ajustée dans le dos par un noeud. Avec grandes poches avant pratiques.  
Estola 100% Poliéster Stretch. Ajustada nas costas com um laço. Com bolsos à frente grandes e cómodos.

## Étole collier mao

### Estola colarinho mao

MOD.21602130

u.m.vta: 1  40

Étole Mao, avec crochets métalliques, mini manches, avec et poches, lacets dans le dos pour ajuster à la taille.

Mao roubou, com fechos de metal, mini manga, frente com ourelas e bolsos, ajuste de cintura com fitas que cruzam na parte de trás e amarram na cintura.



100% polyester  
100% poliéster

REF.06309/50

100% polyester  
100% poliéster

REF.06309/63

100% polyester  
100% poliéster

REF.06309/68

50% polyester, 50% coton  
50 % poliéster, 50% algodão

REF.06309/72



36/37 cm  
59/60 cm  
75/76 cm



## Étole col V



### Estola decote em V

u.m.vta: 1  40

MOD. 21602100

REF.07558



 36 cm  
 51 cm  
 78 cm

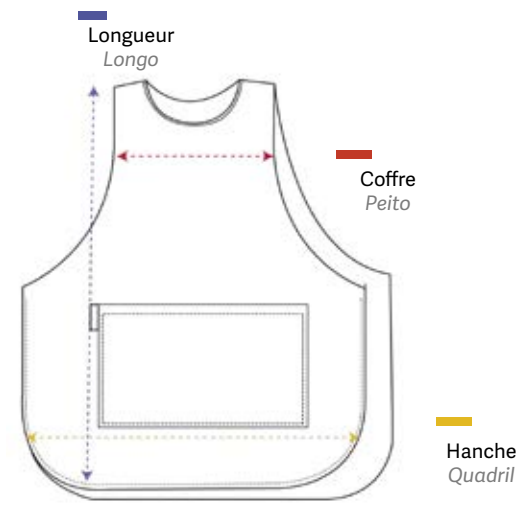

Étole 100% Polyester Stretch. Ajustée dans le dos par un noeud. Avec grandes poches avant pratiques.  
 Estola 100% Poliéster Stretch. Ajustada nas costas com um laço. Com bolsos à frente grandes e cómodos.

## Pantalons femmes

### Calças mulher



u.m.vta: 1  40



MOD. 41300011B

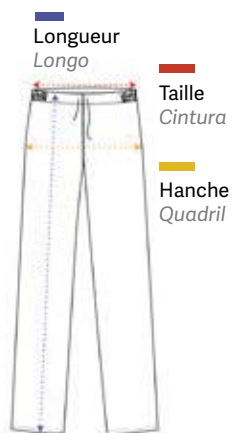

- 60 % polyester
- 33 % coton



- 60% poliéster
- 33% algodão



**S**  
 92-96 cm  
 92-96 cm  
 99-101 cm

**M**  
 98-102 cm  
 96-100 cm  
 101-103 cm

**L**  
 106-110 cm  
 106-110 cm  
 102-104 cm

**XL**  
 112-116 cm  
 114-118 cm  
 105-107 cm



REF.06312/58/1

REF.06312/58/2

REF.06312/58/3

REF.06312/58/4

## Anneau lumineux à LED 045 cm avec trépied LED anelar 045 cm com tripé

u.m.vta: 1  5 

REF. 07003



- Diamètre de lumière anneau à del 18 "
- Poids net de la lumière anneau: 1,07 kg
- Couleur de la bague: noir
- Puissance: 50w
- Tension: ac100 / 240v
- Alimentation: cordon d'alimentation
- Quantité de led: 288 perles de led
- Température de couleur: 2700k / 5700k
- Couleur led: blanc pur / blanc naturel / blanc chaud / blanc froid
- 2 Ports usb
- Pièces: 1 pc de 18 "led ring light / 3 pcs de supports de téléphone tuyau / 1 télécommande
- Obturateur bluetooth / 1 pc de 2,5m. Support de trépied droit / 1 de sac de transport
- Emballage: ring light séparé emballé ensemble et trépied emballé ensemble

- *Diamètre de lumière anneau à del 18 "*
- *Poids net de la lumière anneau: 1,07 kg*
- *Couleur de la bague: noir*
- *Puissance: 50w*
- *Tension: ac100 / 240v*
- *Alimentation: cordon d'alimentation*
- *Quantité de led: 288 perles de led*
- *Température de couleur: 2700k / 5700k*
- *Couleur led: blanc pur / blanc naturel / blanc chaud / blanc froid*
- *2 Ports usb*
- *Pièces: 1 pc de 18 "led ring light / 3 pcs de supports de téléphone tuyau / 1 télécommande*
- *Obturateur bluetooth / 1 pc de 2,5m. Support de trépied droit / 1 de sac de transport*
- *Emballage: ring light séparé emballé ensemble et trépied emballé ensemble*

## Anneau lumineux LED 026 cm pour bureau avec trépied

### Anel de luz LED 0.26 cm para mesa com tripé

u.m.vta: 1  10 

REF. 07293

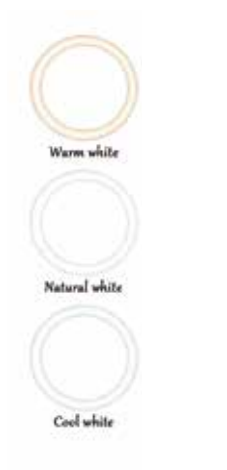

- Diamètre de la lumière anneau led. Dix"
- Poids net léger anneau: 0,24 kg
- Couleur de la bague: noir
- Puissance: 8 / 12w
- Tension: ac85 / 240v
- Alimentation: alimenté par usb
- Quantité de led: 120 perles de led
- Température de couleur: 3000k / 6500k
- Couleur led: blanc pur / blanc naturel / blanc chaud / blanc froid
- Pièces: 1 lumière anneau led 10 "pc / 1 support de trépied de bureau de 14 cm pc / 1 tuyau pc
- Support téléphone / 1 pc ball head / 1 pc phone clip / 1 pc remote bluetooth
- Obturateur / 1 support téléphone réglable / 1 trépied 1,6 pc / 1 sac de transport

- Diâmetro de luz anel led. 10 "
- Ring light net weight: 0,24 kg
- Cor do anel: preto
- Potência: 8 / 12w
- Tensão: ac85 / 240v
- Fonte de alimentação: usb powered
- Led q'ty: 120 led beads
- Temperatura de cor: 3000k / 6500k
- Cor do led: branco puro / branco natural / branco quente / branco frio
- Peças: 1 pc luz anel led 10 "/ 1 pc desktop tripé suporte / 1 mangueira pc
- Suporte de telefone / 1 cabeça de esfera de pc / 1 clipe de telefone de pc / 1 bluetooth remoto de pc
- Obturador / 1 porta telefone ajustável pc / 1 pc 1,6 tripé / 1 saco de transporte



## Malette outils Maleta útil

u.m.vta: 1	 1
------------	---

●  
**REF. 07320/50**



●  
**REF. 07320/63**

●  
**REF. 07321/50**



●  
**REF. 07321/63**

- Matière: cuir synthétique
- Idéale pour ranger les produits de maquillage et les petits outils.
- Fermeture: glissière

- Material: Couro sintético
- Ideal para armazenar produtos de maquiagem e pequenos utensílios.
- Encerramento: zíper

Toutes les valises sont vendues vides  
 Todas as malas vendidas vazias

u.m.vta: 1		4
------------	---	---

Pour outils, à l'intérieur se trouve 6 compartiments et 4 plateaux  
 Para ferramentas, interior 6 compartimentos e 4 bandejas



**REF.03598**



**REF.03599**

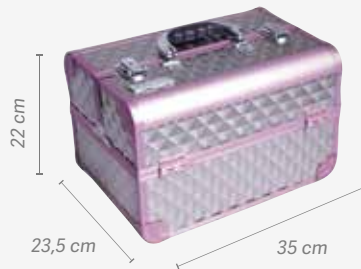

u.m.vta: 1		6
------------	---	---





**REF.02318**



u.m.vta: 1		4
------------	---	---

**REF.02317**



**Valise en aluminium****Mala alumínio**u.m.vta: 1  4Toutes les valises sont vendues vides  
Todas as malas são vendidas vazias**REF.01492****Valise noire en PVC****Mala PVC cor preto**u.m.vta: 1  4Toutes les valises sont vendues vides  
Todas as malas são vendidas vazias**REF.02925****Set de 3 valises PVC assorties****Conjunto 3 MALAS PVC**u.m.vta: 1  4Toutes les valises sont vendues vides  
Todas as malas são vendidas vazias**REF.02594****Valise trolley****Trolley**u.m.vta: 1  1Avec compartiments et miroir  
Com compartimentos e espelho**REF.03814/50**

## Valise pour maquillage, cosmétique et esthétique Mala de maquiagem, cosméticos e estética

u.m.vta: 1		4
------------	---	---

Avec 4 plateaux amovibles et 12 compartiments variables. Grand espace à l'intérieur pour les produits plus grands. Deux serrures et deux clés de rechange incluses.

Com 4 bandejas removíveis e 12 compartimentos variáveis. Com amplo espaço interno para produtos maiores. Inclui duas chaves (abrir / fechar).



REF.04940/50



REF.04940/54



REF.04940/70



u.m.vta: 1		4
------------	---	---

Avec des plateaux amovibles (2 de chaque côté), chaque bac dispose de 4 compartiments. Grand espace intérieur classable en 4 sections. Comprend à l'intérieur une bandoulière pour accrocher la valise sur l'épaule. Deux serrures et deux clés de rechange incluses.

Com bandejas removíveis (2 de cada lado), cada bandeja tem 4 compartimentos. Ótimo espaço interior classificável em 4 seções. Inclui no seu interior uma banda para pendurar a mala no ombro e duas chaves (abrir / fechar).



REF.04941/50



REF.04941/54



REF.04941/70



## Valise pour maquillage, cosmétique et esthétique Mala de compartimentos

u.m.vta: 1	 4
------------	---

REF.04942/50





REF.04942/54

Avec plateaux amovibles (2 de chaque côté). Chaque plateau a 4 espaces rangement. Grand espace intérieur avec bandoulière pour le transporter. 2 serrures et 2 dés de rechange incluses.

Com bandejas removíveis (2 de cada lado). Cada bandeja tem 4 compartimentos. Ótimo espaço interior classificável em 4 seções. Inclui uma banda dentro para pendurar a mala no ombro e duas taças com duas chaves de (abrir / fechar).

## Sac porte-outils noir Bolsa porta-ferramentas cor preto

u.m.vta: 1	 6	
------------	---	---

REF. 02516



## Valise trolley 4 compartiments

### Mala 4 compartimentos

Toutes les valises sont vendues vides  
Todas as malas são vendidas vazias

u.m.vta: 1		1
------------	---	---

La valise trolley de Pollié, est créée sur la base d'une structure de 2 corps modifiables, conçue pour faciliter le rangement professionnel de vos ustensiles de coiffure, de maquillage ou de cosmétique.

Le haut de la valise se compose de trois plateaux amovibles. Chacun d'eux est divisé en trois compartiments. Ainsi, dans l'un d'eux, vous trouverez douze espaces circulaires conçus pour stocker les laques à ongles et ainsi empêcher leur détachement, facilitant leur transport en toute sécurité. De plus, l'intérieur du haut du corps peut être modifié selon vos besoins, en variant la structure des compartiments. Enfin, sa fonction 2 en 1 leur permettra d'avoir un sac à main, ou ils préfèrent l'accrocher à l'homme, grâce à sa bande en nylon.

La partie inférieure de la valise a un plateau amovible avec l'option de 4 compartiments qui peuvent également être modifiés grâce aux entretoises. Le bas du corps, avec une grande capacité à l'intérieur, vous donnera la possibilité d'un transport plus léger, car il peut être converti en une valise plus petite, avec un couvercle et un miroir incorporés. Les roues sont interchangeableables à l'aide de la languette d'attelage. Le chariot a deux bobines et deux clés de rechange

*A mala de carrinho de Pollié é criada com base em uma estrutura de 2 corpos modificáveis, projetados para facilitar o armazenamento profissional de seus utensílios de cabeleireiro, maquiagem ou cosméticos.*

*A parte superior da mala consiste em três bandejas removíveis. Cada um deles é dividido em três compartimentos. Assim, em um deles, você encontrará doze espaços circulares projetados para armazenar vernizes de unhas e, assim, impedir seu desapareço, facilitando o transporte com total segurança. Além disso, o interior da parte superior do corpo pode ser modificado de acordo com suas necessidades, variando a estrutura dos compartimentos. Finalmente, sua função 2-em-1 permitirá que eles tenham uma bolsa, ou eles preferem pendurá-la no homem, graças à sua tira de nylon.*

*A parte inferior da mala possui uma bandeja removível com a opção de 4 compartimentos que também podem ser modificados graças aos espaçadores. A parte inferior do corpo, com grande capacidade interna, oferece a opção de transporte mais leve, pois pode ser convertida em uma mala menor, com tampa e espelho incorporados. As rodas são intercambiáveis usando a aba do engate. O carrinho possui duas bobinas e duas chaves (abrir / fechar).*



REF.04939/50



REF.04939

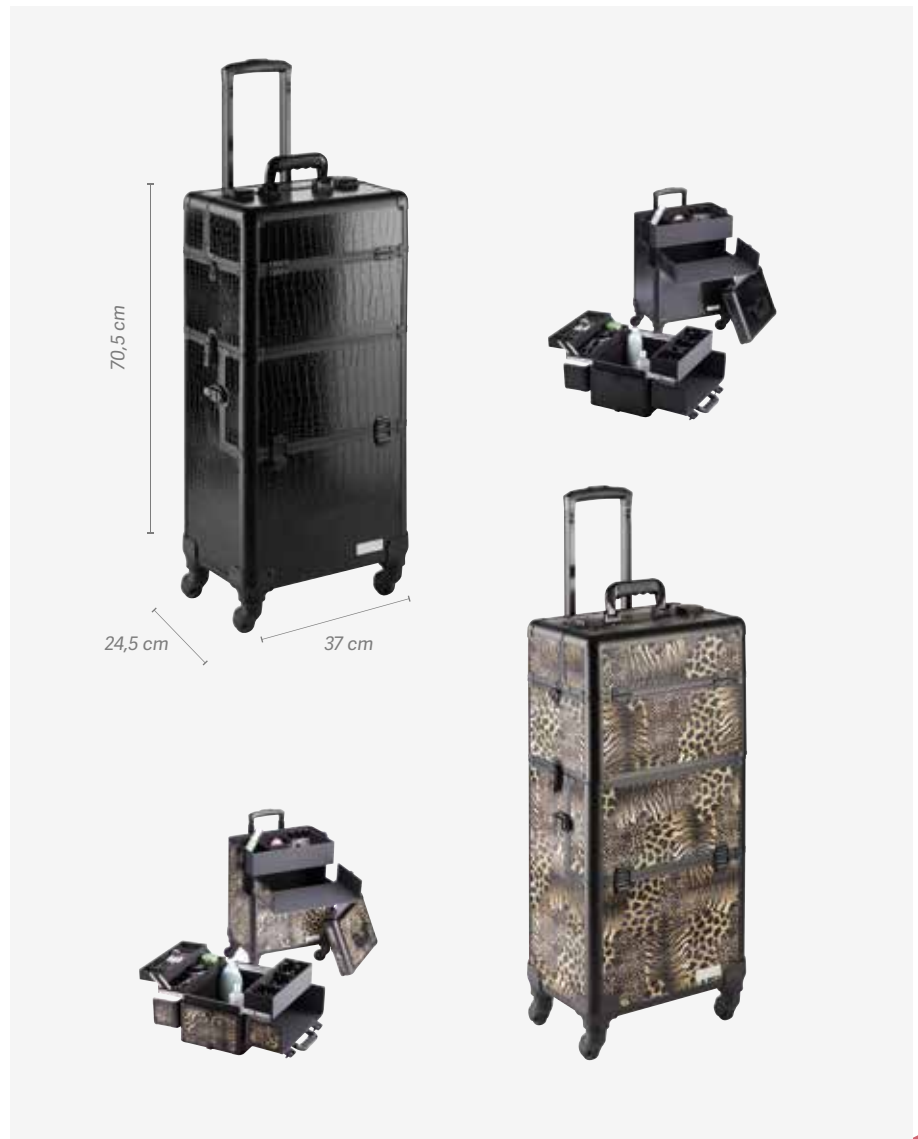



**Boîte de rangement accessoires coiffure (vide)**  
**Caixa organizadora (Vazia)**

Vides  
 vazia

u.m.vta: 1  24

REF.04722





u.m.vta: 1  12

REF.04309

Aimanté  
 Magnetizado

**Pulvérisateur de couleurs transparent**  
**Pulverizador cores transparente**

u.m.vta: 12  84 

300 ml

    
 REF.01372

330 ml

    
 REF.00959

Rond  
 Redondo

300 ml

    
 REF.01484

300 ml

   
 REF.01663



**porte carte visite aluminium**  
**Porta-cartoes**

u.m.vta: 1  400

**REF.02470**



**Flacon avec pompe de dosage**  
**Frasco dosificador**

u.m.vta: 20  80

240 ml

**REF.02880**



**Protecteur oculaire à lentille UV étui inclus**  
**Protetor ocular UV lente com estojo**

u.m.vta: 10  100

Comprend une lentille centrale permettant la vision  
*Inclui uma lente central que permite visão*

**REF.03195**

Pas de vision  
*Sem visão*

**REF.03194**



- Modèle comprenant un nouveau système de fixation spécial basé sur une fourche en fibre plastique transparente
- Avec étui pour ranger le protecteur

- Modelo que inclui um novo sistema de fixação especial baseado em um garfo de fibra de plástico transparente
- Com estojo para guardar o protetor Com fixação especial baseada num gancho de fibra de plástico

**Articles en vente exclusive en ESPAGNE**  
**Artigos exclusivo de venda EM ESPANHA**

**Antiseptique daromix gh**  
**Antiséptico daromix gh**

u.m.vta: 1  12

1 L

REF.06200



- Numéro d'enregistrement AEMPS: 905-DE5
  - Antiseptique hydroalcoolique pour la désinfection hygiénique des mains par friction.
  - Efficacité scientifiquement garantie
  - Biocide à large spectre de 30 sec.
  - Formule hypoallergénique
  - Préserve l'hydratation de la peau
  - N'irrite pas la peau
  - Sèche rapidement
  - Efficace comme: Bactéricide · Levuricide · Virucide · Microbactéricide
- Número de registo AEMPS: 905-DE5
  - Anti-séptico hidroalcoólico para desinfeção higiénica de mãos por fricção
  - Eficácia cientificamente garantida
  - Biocida de amplo espectro a partir de 30 seg
  - Fórmula hipoalergênica
  - Preserva a hidratação da pele
  - Não irrita a pele
  - Seca rapidamente
  - Eficaz como: Bactericida · Levuricida · Virucide · Microbactericida

**Désinfectant au limoseptol**  
**Desinfetante limoseptol**

u.m.vta: 1  20 

50 ml

REF. 06151

u.m.vta: 1  20



1 L

REF.06150



- Numéro d'enregistrement AEMPS: 47-DE5
  - Produit de haut niveau développé exclusivement pour l'hygiène, nettoyage et désinfection, pour les ustensiles professionnels de salon de beauté
  - Action détergente - Large spectre
  - Biodégradable - Sans phosphates et sans formol
  - Efficacité germicide et SANITIZER contre: Bactéries, levures et champignons
- Número de registo AEMPS: 47-DE5
  - Produto de alto nível desenvolvido exclusivamente para higiene, limpeza e desinfeção, para utensílios profissionais de salão de beleza
  - Ação detergente - amplo espectro
  - Biodegradável - sem fosfatos e sem FORMOLO
  - Eficácia germicida e SANITIZER contra:
  - Bactérias, leveduras e fungos.

### Bouteille spécial pour gel et solution hydro-alcoolique garrafa especial para gel e solução hidroalcoólica

u.m.vta: 1  3 



Avec support mural  
Com suporte para a parede

300 ml

REF.07280



### Désinfectant de surfaces en spray Higienizante de superfícies em spray

u.m.vta: 1  12 

500 ml

REF.07232

Idéal pour la désinfection et le nettoyage de tout type de surfaces: métallique, plastique, verre et céramique.

- Mobilier, portes, rampes, jouets, toilettes, claviers d'ordinateur, souris, écrans... Postes de travail

#### CARACTÉRISTIQUES ET AVANTAGES

- Inoffensif au contact avec la peau
- Nettoyage et désinfection rapides et efficaces
- Évaporation complète, sans laisser de résidu
- N'attaque pas les plastiques ni les caoutchoucs

*Idéal para a higienização e limpeza de qualquer tipo de superfícies: metálicas, plásticas, vidro e cerâmica.*

- *Mobiliário, portas, parapeitos, brinquedos, sanitas, teclados de computador, ratos, ecrãs, postos de trabalho...*

#### • CARACTERÍSTICAS E VANTAGENS

- *Inócuo em contacto com a pele*
- *Rápida e efetiva ação de limpeza e higienização*
- *Evapora completamente, sem deixar resíduos*
- *Não ataca plásticos nem borrachas*



## Porte-savon en plastique Saboneteiro plástico

u.m.vta: 1	 40
------------	--

REF.02197

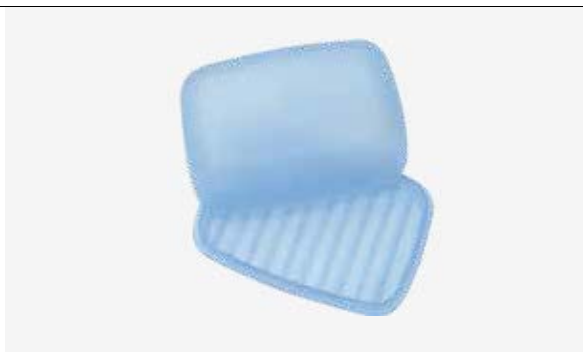

## Déboucheur à soufflet pour évier et WC Desatascador w.c

u.m.vta: 10	 10
-------------	--

REF.00931



## Manche à balai Punho vassoura

Fil espagnol et italien  
Rosca espanhol e italiano

u.m.vta: 12	 12
-------------	--

REF.01131

- Nettoyage facile et longue durabilité
- Support plastique
- Idéal pour tous les types de sols, en particulier le parquet

- Limpeza fácil e longa durabilidade
- Suporte de plástico
- Ideal para todos os tipos de pisos, especialmente parquet



u.m.vta: 10	 10
-------------	--

REF.01365

- Extra télescopique
- Telescópico extra



## Balais en caoutchouc Vassouras de borracha

u.m.vta: 4		16
------------	---	----

Avec languette  
Com aba

**REF.01223**



u.m.vta: 5		20	
------------	---	----	---

**REF. 01285/50**



u.m.vta: 5		20
------------	---	----

**REF.02420**



- Facile à nettoyer et durable, l'efficacité de la conception de ses pointes parvient à faire glisser la poussière sans la soulever, ce qui la rend idéale pour les personnes allergiques car elles favorisent un environnement propre.
- Fácil de limpar e duradoura, a eficácia do design de seus espigões consegue arrastar o pó sem levantá-lo, tornando-o ideal para quem sofre de alergias, pois favorece um ambiente limpo.



TASSEL

08

## Mobilier Mobiliário

*Table de massage, tabourets, chaises, supports,  
chariots, porte-documents et fauteuils de maquillage...*

*Marquesas, Tambonetes, cadeiras,  
carrinhos, malas e cadeiras de maquiagem...*



**Table de massage pliable portable**  
**Marquesa massagem portátil**

u.m.vta: 1  1

Poid: 17,5 kg  
 Peso: 17,5 kg

**REF.07384**



**Table de massage pliable portable**  
**Marquesa portátil**

u.m.vta: 1  1



- Aluminium
- Poid: 16 kg

- Alumínio
- Peso: 16 kg

**REF.07385**



### Table de massage structure métallique Marquesa massagem estrutura metálica

u.m.vta: 1  1 



**REF.02738**

- Densité de mousse: 30kg/m<sup>3</sup>
- Poids: 17 kg

- Densidade da esponja: 30kg/m<sup>3</sup>
- Peso: 17 kg



### Table de massage spéciale Marquesa especial massagem

u.m.vta: 1  1 

**REF. 02739**

**REF. 02739/50**

- Densité de mousse: 30kg/m<sup>3</sup>
- Poids: 31 kg
- Densidade da esponja: 30kg/m<sup>3</sup>
- Peso: 31 kg



### Dérouleur de papier pour table de massage Porta rolo papel Marquesa

u.m.vta: 1  5

Support mural  
Suporte de parede

**REF.01168**



### Table de massage hydraulique 3 corps Marquesa hidráulica 3 corpos

u.m.vta: 1  1 

REF. 03031

- Densité de mousse: 62kg/m<sup>3</sup>
- Avec une cavité faciale (trou) sous le coussin d'appui-tête.
- Épaisseur PVC 1.1 / 1.2cm
- Mousse blanche 1ère qualité
- Confortable, solide et polyvalente.

- Densidade da esponja: 30kg/m<sup>3</sup>
- Braços extraíveis.
- Com orifício facial por baixo da almofada do repouso-cabeças.
- Espessura PVC 1.1 / 1.2cm
- Espuma branca 1ª qualidade
- Cômuda, sólida e versátil.



### Table de massage électrique 3 corps Marquesa elétrica 3 corpos

u.m.vta: 1  1

REF.03030

- Densité de mousse: 30kg/m<sup>3</sup>
- Avec le trou facial sous le coussin d'appui-tête.
- Mousse blanche 1ère qualité.
- Siège 9,5 cm
- Confortable, solide et polyvalente.
- 3 corps - 3 moteurs
- Supporte 200 Kg.
- Poids: 70 kg

- Densidade da esponja: 30kg/m<sup>3</sup>
- Com orifício facial sob a almofada do encosto de cabeça.
- Espuma branca de primeira qualidade.
- Assento 9,5 cm
- Cômuda, sólida e versátil.
- 3 corpos - 3 motores.
- Suporta 200 Kg
- Peso: 70 kg



## Table de massage spa Marquesa spa

u.m.vta: 1  1

**REF.03032**

- Appuie-tête NON amovible
- Poids: 53 kg
- Apoia-cabeças NÃO desmontável
- Peso: 53 kg



## Marche pied en bois pour spa Escada madeira spa

u.m.vta: 1  1

**REF.03072**



**Paravent en bois pour spa**  
**Biombo madeira spa**

u.m.vta: 1		1
------------	---	---

REF.03078



**Étagère en bois pour spa**  
**Estante madeira spa**

u.m.vta: 1		1
------------	---	---

REF.03071





## Table de manucure Mesa manicure

u.m.vta: 1  1

**REF.02139**

- Table de manucure composée d'une planche en bois blanc, d'un pied en aluminium et d'un meuble thermoformé à roulettes
- Comprend une lampe, repose-poignet en mousse et un organisateur d'outils pratique
- Sans aspirateur
- Poids: 22 kg

- Mesa manicure composta de tabuleiro em madeira branco, pé de alumínio e móvel termo-conformado com rodas
- Inclui lâmpada, espuma apoia-mãos e um prático organizador de ferramentas
- Sem aspirador
- Peso: 22 kg



## Table de manucure avec aspiration Mesa manicure com aspiração

u.m.vta: 1  1

**REF.03067**

- Table de manucure composée d'une planche en bois blanc, d'un pied en aluminium et d'un meuble thermoformé à roulettes
- Comprend une lampe, repose-poignet en mousse et un organisateur d'outils pratique
- Avec aspirateur
- Poids: 22kg

- Mesa manicure composta de tabuleiro em madeira branco, pé de alumínio e móvel termo-conformado com rodas
- Inclui lâmpada, espuma apoia-mãos e um prático organizador de ferramentas
- Com aspirador 20W
- Peso: 22kg



**Table de manucure pliante avec aspiration et roues**  
**Mesa manicure articulável com aspiração e rodas**

u.m.vta: 1  1

**REF.04278**

- Aspirateur 3000 pro
- Poids: 12 kg
- 30W

- Aspirador de 3000 rpro
- Peso: 12 kg
- 30W

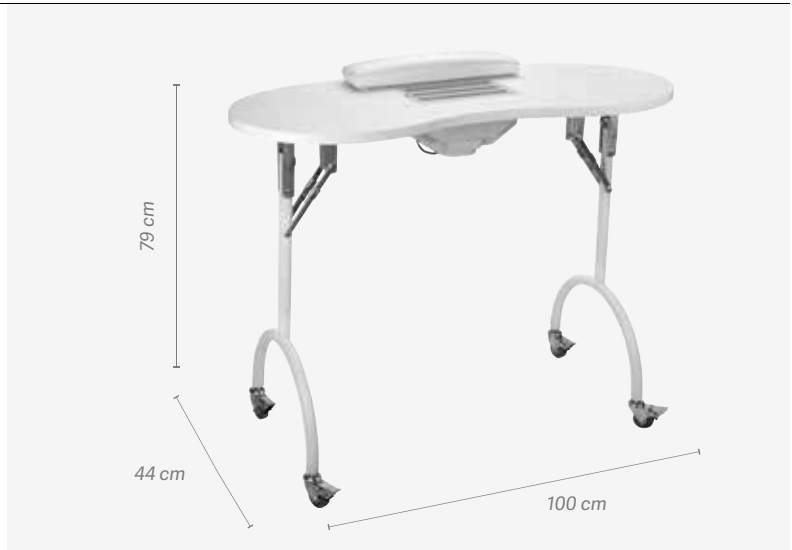

**Table de manucure en bois blanc**  
**Mesa manicure em madeira branca**



u.m.vta: 1  1

- Poids: 33 kg
- Peso: 33 kg

**REF.03934**



**Chariot d'esthétique POLLIÉ**  
**Carrito estética POLLIÉ**

u.m.vta: 1  1 

- Poids: 22 kg
- Peso: 22 kg

**REF. 02839**



**SCAN ME!**



## Lampe pour table manucure Lâmpada mesa manicure

u.m.vta: 1	 1
------------	---

REF.03187

- Lampe en couleur aluminium
- Lumière au néon
- Mesure : 72 cm
- Fourni avec fluorescent 20W et pièce de rechange supplémentaire.

- Lâmpada de cor alumínio
- Luz de néon
- Medida: 72 cm
- Fornecida com fluorescente de 20W



## Chariot manucure / pédicure Carrinho manicure/ pedicure

u.m.vta: 1	 1
------------	---

●  
REF.03944/50

○  
REF.03944/58



### Comptoir de réception bois et métal à effet miroir

#### Desk receção de madeira e metal efeito espelho

u.m.vta: 1  1

REF.03935



### Canapé d'attente 3 places

#### Sofá de espera 3 lugares

u.m.vta: 1  1

En skai  
Em pele ecológica

REF.03950



### Meuble coiffure de réception EARTH

#### Mesa-recepção EARTH

u.m.vta: 1  1

Graphite · Grafite



REF.04518/50

Chêne · Mural



REF.04518/65

Blanc · Branco



REF.04518/58

- Laminé
- Avec étagères réglables et 1 tiroir

- Laminado
- Com prateleiras ajustáveis e 1 gaveta

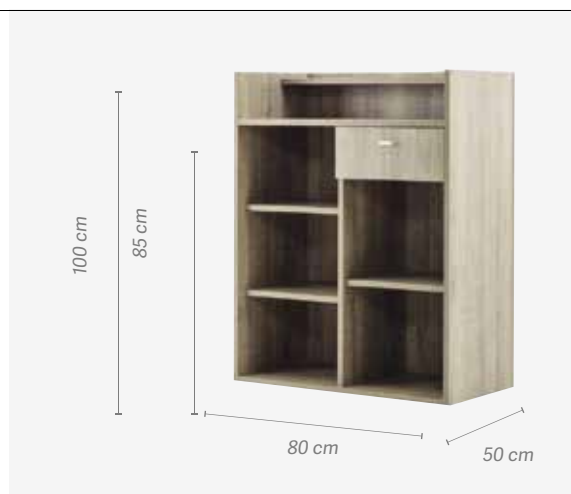

### Tabouret STREET Tambonete STREET

u.m.vta: 1  1

REF.06103/50

SCAN  
ME!

REF.06103/58



Tabouret STREET classique avec pompe hydraulique pour ajuster la hauteur désirée dans chaque travail.

Tambonete STREET clássica com bomba hidráulica para regular a altura conforme desejado em cada trabalho.

Comparatif 04419 - 06103  
Comparativo 04419 - 06103



### Tabouret base en métal Tambonete base metal

u.m.vta: 1  1

REF.04419/50

SCAN  
ME!

REF.04419/58



### Tabouret mod. RODEO Tambonete mod. RODEIO

u.m.vta: 1  1

REF.01964



## Tabouret URBAN

### Tambonete URBAN

u.m.vta: 1	 1
------------	---

● **REF.06102/50**

Tabouret ergonomique URBAN avec pompe hydraulique pour ajuster la hauteur désirée dans chaque travail. Sa forme s'adapte au corps et par conséquent favorise une meilleure posture et évite le mal de dos après plusieurs heures de travail.

○ **REF.06102/58**

Tambonete URBAN ergonómico com bomba hidráulica para regular a altura conforme desejado em cada trabalho. A sua forma adapta-se ao corpo e como consequência propicia uma melhor postura e evita as dores de costas depois de muitas horas de trabalho.



SCAN ME!



**Comparatif 04382 - 06102**  
Comparativo 04382- 06102



## Tabouret avec une base en métal

### Tambonete base metal

u.m.vta: 1	 1
------------	---

● **REF.04382/50**

○ **REF.04382/58**





SCAN ME!



## Fauteuil basculant

### Cadeira basculante

u.m.vta: 1	 1	
------------	---	---

○ **REF. 02975/58**

- Inclinaison 130° / Hydraulique
- Largeur du bras au bras: 57 cm
- Tête de chaise d'Anchua: 19 cm
- Tête amovible avec une position
- Dossier 51 x 41 cm
- Hauteur de la tête: 13 cm
- Distance entre le dossier et la tête 14 cm
- Poids: 32,5 kg

- Reclinável 130° / Hidráulica
- Largura do braço ao braço: 57 cm
- Cabeça de cadeira de ancoragem: 19 cm
- Cabeça removível com uma posição
- Encosto 51 x 41 cm
- Altura da cabeça: 13 cm
- Distância entre o encosto e a cabeça 14 cm
- Peso: 32,5 kg





### Chaise avec support et système de régulation Cadeira com encosto e regulação

u.m.vta: 1  1

REF.02730/58



### Chaise avec support et système de régulation Cadeira com encosto e regulação

u.m.vta: 1  1

REF.02732



REF.02732/58



### Chaise avec support et système de régulation Cadeira com encosto e regulação

u.m.vta: 1  1

REF.03937/50



REF.03937/58



### Tabouret FASHION Cadeira FASHION

u.m.vta: 1  1

REF.06101/58

Tabouret FASHION avec dossier pour plus de confort et de soutien au dos. Les roues sont conçues pour éviter que les cheveux ne s'y coincent. Ils sont faciles à nettoyer.

Cadeira FASHION com encosto para mais comodidade e apoio de costas. As rodas estão concebidas para evitar que o cabelo fique preso nelas. São fáceis de limpar

SCAN  
ME!

### Support de tatouage Suporte tatuagem

u.m.vta: 1  1

REF.04915



- Réglable et inclinable.
- Mousse: 37 x 21 cm
- Regulável e basculante.
- Tapete: 37 x 21 cm

### Appui-tête Apoio-nucas

u.m.vta: 1  1

REF.03842



- Mousse: 23 x 6 cm
- Tapete: 23 x 6 cm

### Support de pédicure Suporte pedicure

u.m.vta: 1  1

REF.03627



- Support de pédicure 20 x 17 cm.
- Inclinable
- 1,94 kg
- Suporte pedicure 20 x 17 cm.
- Basculante.
- 1,94 kg

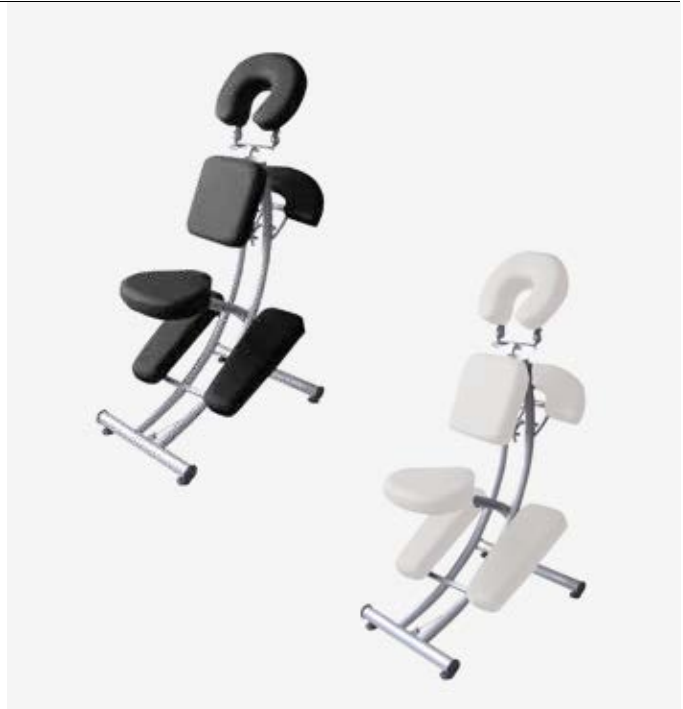

## Chaise de massage Cadeira massagem

u.m.vta: 1  1●  
**REF.02740/50**○  
**REF.02740**

## Chaise spéciale pédicure avec bain de pieds Cadeira especial pedicure com banheira para pés

u.m.vta: 1  1 **REF. 02741**

- Maintient l'eau chaude avec bulles.
- Mantém a água quente e faz borbulhas.

## Fauteuil de pédicure spa Cadeira de pedicure spa

u.m.vta: 1  1**REF. 07341**

- Avec dossier réglable
- Com encosto ajustável



## Valise maquillage

### Mala/espelho de maquiagem

u.m.vta: 1  1

Coiffeuse table de maquillage avec 6 lampes pliables et convertibles dans une valise trolley confortable + 2 gobelets pour les pinceaux. Prise européenne

*Espelho maquiagem com 6 luzes dobrável e convertível numa cómoda maleta trolley*

17 kg

**REF.04937/50**



## Valise maquillage argent

### Mala/espelho de maquiagem

u.m.vta: 1  1

17 kg

**REF.04937/54**



## Appuie-tête chaise maquillage Assento maquiagem dobrável

u.m.vta: 1  6

REF.06157

- Convient uniquement pour réf. 06156/50 et 06156/54.
- Apenas adequado para ref. 06156/50 e 06156/54.



## Chaise de maquillage pliable Cadeira dobradel cor preto

u.m.vta: 1  1

REF.06156/50



REF.06156/54

- Idéal pour le maquillage
- Ideal para maquiagem

**Comprend la housse de transport**  
**Inclui transporte funda**



### Crochet à ventouse

#### Para pendurar

u.m.vta: 15  15

**REF.02904**

- Sac avec deux crochets à ventouse
- Saco com dois suportes de ventosa



### Rangement serviettes

#### Organizadores para pendurar toalhas

u.m.vta: 1  6

**REF.04378**

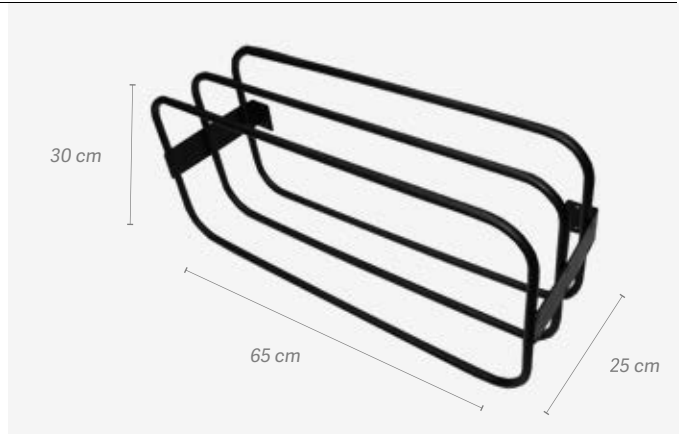

### Conteneur de serviettes

#### Contentor toalhas

u.m.vta: 1  4

**REF.03159**

- Avec des roues Housse conteneur lavable La structure est en acier inoxydable
- Com rodas
- Bolsa contentora lavável
- Estrutura de aço inoxidável
- Stainless steel structure.





ACCESSOIRES	817	CIRE CAPITAIN CUISINIER	505
ACCESSOIRES CIRE	622-623	CIRE FORMAT KG	611-614
ACCESSOIRES COSMÉTIQUES	609	CIRE ROLL-ON HOMME	519
ACCESSOIRES COSMÉTIQUES	680	CISEAUX ACADEMIE SPÉCIALE	373
ACCESSOIRES DE CIRE ROLL-ON	628-629	CISEAUX D'AFFICHAGE	377
ACCESSOIRES DE MANUCURE	721	CISEAUX DE LIGNE DE BARBIER	463-469
ACCESSOIRES ET KITS POLLIE	652	CISEAUX EN TITANE ET DÉCORÉS	359-360
ACCESSOIRES NAIL ART	663-673	CISEAUX EUROSTIL	470-471
ACCESSOIRES POUR TOURS	685	CISEAUX INITIATION	372-472
ACCESSOIRES TEINTE	59-60	CISEAUX INITIATION	373
ACTIVATEURS	28-29	CISEAUX PEAU ET ONGLES	722-723
ADHÉSIF POUR FIXER LES CHEVEUX RIDEAU	384	CISEAUX POUR GAUCHER	366
ADHÉSIFS CILS	773	CISEAUX PROFESSIONNELS	361-365,367-372
AFFICHAGE CAPITAIN COOK	506	CISEAUX RAGNAR	464-465
AFFICHAGE FIBRES CAPILLAIRES	519	CISEAUX RASOIR	366
AGRAFES	189-191	CISEAUX SPÉCIAUX GAUCHERS	473
AIGUILLES ÉLECTRIQUES	636	CIVIÈRES	823-826
AMPOULES DE PRÉVENTION DES CHUTES	517	CLIPS	169-173,383
ANDREA CILS	767-768	CLIPS AVEC PERLES	200-201
ANDREA SOURCILS	775	CLIPS ET PINCES	188
ANNEAU LUMINEUX À DEL	808-809	COCKTAIL SHAKERS ET MÈTRES	75
ANTI-CELLULITE ET RAFFERMISANT	605	COFFRET BROCHETTES	343
APRÈS RASAGE SPLASH	508	COFFRET PINCEAUX DE MAQUILLAGE	760-761
APRÈS-RASAGE MYRSOL	513	COFFRETS PEIGNE	302-303
ARC REMBOURRÉ	353-357	COIFFURES ET CAPES	542
ARROSEURS	68-73	COLORANT DE COULEUR BRILLANTE	121-132
ASPIRATEUR POUR CHEVEUX	57-442	COMBERS	84-85
ATOMISEUR FIBRE CAPILLAIRE	518	COMPTOIRS D'ACCUEIL ET AUTRES	533-534
BAGUES	382	COMPTOIRS ET MIROIRS	217-218
BAGUETTES EN BOIS	331	CONTENEUR DE SERVIETTES	535-839
BALAIS	569	CONTENEUR POUR CISEAUX	377
BALAIS EN CAOUTCHOUC	410	CORRESPONDANCES HÉMOSTATIQUES	516
BANDAGES À FROID EN ROULEAU	608	COSMÉTIQUES POST-ÉPILATION	634-635
BANDES DE CIRE	631-633	COTON	387,791-792
BANDES MECHAS	61-62	COUCHES	90-101,543-545
BARBER LINE FUSION DE CIRE NOIRE	441	COUPE-CHEVEUX	377
BAUME À BARBE	509	COUPE-ONGLE	718
BAUME MOUSTACHE	509	COUPE-ONGLES ARTIFICIEL	718
BIGOUDES EN PLASTIQUE	332-334	COUSSINS SPÉCIAUX ENFANTS	220-530
BOÎTE DE RANGEMENT (VIDE)	399	COUTEAU BARBER LINE	449-452
BOLS	64-67	COUTEAUX DE POCHE CAPITAIN COOK	453-454
BOUCLES CILS	774	COUTEAUX DE POCHE ET LAMES PLUME	456
BRINS	772	COUTEAUX DE POCHE JETABLES POLLIE	377
BROSSE À BARBE RAGNAR	478	COUTEAUX DE POCHE RAGNAR	447-448
BROSSE À SOUFFLET DÉMÉLANT	257	COUTEAUX EUROSTIL	455
BROSSE A SOUFFLET MANCHE PLASTIQUE	258-263	COUTEAUX JETABLES	460
BROSSE BARBER LINE	479	COUTEAUX SOURCILS POLLIE	775
BROSSE CIRCUOLAIRE	286	COUVERCLES POUR COUPE-ONGLES ET GOGGING	719
BROSSE CIRCUOLAIRE EN BOIS	249-251	COUVERTURES ET SERVIETTES	778-779
BROSSE CIRCUOLAIRE EN PLASTIQUE	249	COUVERTURES ET TENDEUR DE PAPIER	777
BROSSE DÉMÉLANTE	267	CRAYON A SOURCILS EN BOIS POLLIE	740
BROSSE EN BOIS AVEC MANCHE EN CAOUTCHOUC	252	CRAYON EN BOIS LÈVRES POLLIE	740
BROSSE PROFESSIONNELLE OVALE	259	CRAYON YEUX EN BOIS POLLIE	739
BROSSE RAGNAR	481	CRAYONS EN PLASTIQUE POLLIE	737
BROSSE SHAMPOING MASSEUR	319	CRÈME POUR LES MAINS	660
BROSSE SOUFFLET MANCHE BOIS	252	CRÈME ROCK BOUCLES	503
BROSSE SPHÉRIQUE 3D	269	CRÈMES ET TRAITEMENTS	583-585,587,589
BROSSE THERMIQUE	286	CROCHET METAL PEIGNE MECHAS	350
BROSSE THERMIQUE ÉLECTRIQUE	52	CROCHETS SAC MECHAS	350
BROSSES	476	CYLINDRE POUR BROSSES ET BROSSES	747
BROSSES	759	DÉCAPANT À POLIR	658-660
BROSSES	784	DÉSINFECTANT, STÉRILISATEURS	563-565
BROSSES À CRÈPE	247	DIFFUSEURS	26-27
BROSSES A SOUFFLET MANCHE EN CAOUTCHOUC	264-265	DISPLAY TASSEL CELLULES ACTIVES	586
BROSSES BARBER LINE	480-481	DISTRIBUTEUR	80
BROSSES D'AFFICHAGE	758	DISTRIBUTEUR PEIGNE USAGE UNIQUE	297
BROSSES DE BARBIER	475	DISTRIBUTEURS	409
BROSSES EN BAMBOU	255	DISTRIBUTEURS DE GEL	568
BROSSES EUROSTIL	482-483	DOUCHE AVEC SUPPORT	243, 535
BROSSES MANCHE BOIS	755-757	DOUCHE AVEC SUPPORT LAVACAZEZAS	244, 536
BROSSES PLATES DÉMELAGE	277	EAU MICELLAIRE	580
BROSSES PNEUMATIQUES	266	ÉCHELLE EN BOIS SPA	826
BROSSES POUR FER	278	ÉCHELLES	62-63
BROSSES RAGNAR	479	ÉCRAN FACIAL	400
BROSSES SOUFFLET MANCHE BOIS	253-254,256	ÉCRAN FACIAL FACEPRO	399
BROSSES SPIRALES	248	EMAIL POLLIE	647-651
BROSSES SQUELETTE	272-276	ÉMULSION DE RASAGE SANS ALCOOL	513
BROSSES THERMIQUES	283-284	ENSEMBLE DE DOUCHE ADAPTABLE	243-535
BROSSES THERMIQUES EN ALUMINIUM	285	ENSEMBLE DE RASAGE BARBER LINE	478
BROSSES THERMIQUES EN CÉRAMIQUE	282	ENSEMBLE MONOCOMMANDE ET DOUCHE	536
BROSSES THERMIQUES IONIQUES	282	ÉPONGES DE MAQUILLAGE	744-746
BUSES EUROSTIL	435	ÉPONGES DÉMAQUILLANTES	742-743
CANETTES COLOR PEIGNES	315-319	ÉPONGES KONJAC	599
CANNE DE MASSAGE VIBRANTE	607	ETUI À CISEAUX	374-376
CAOUTCHOUCS ET LIENS	192-198	EXFOLIANT VISAGE	580
CAP	344,346-349,351	EXPOSANT RETOUCHE ROOTS RAGNAR	497
CAPES À USAGE UNIQUE	86-89	EXPOSANTS	740
CAPES POUR ENFANTS	104-105	EXTENSIONS D'ÉCHANTILLON DE COULEUR	385
CAPITAINE BARBERSHOP TAPIS	437	EYELINER	741
CAPITAINE COOK HUILES	505	FAUTEUILS DE COIFFEU	233
CAPITAINE COOK COUPE	547	FEUILLE D'ALUMINIUM	77-79
CAPITAINE COOK CRÈME	499	FIBRES CAPILLAIRES	164-518
CAPITAINE COOK CRÈMES	505	FILET SECHOIR TRIANGULAIRE	345
CAPITAINE COOK SHAMPOING	499	FIXATION EFFET SEC	502
CAPITAINE CUISINIER	498-504	FLACONS APPLICATEURS GRADUÉS	76
CAPITAINE CUISINIER CISEAUX	466-468	FORMAT CIRE ROLL-ON	624-627
CAPTAIN COOK BARBE PACK	504	FOURCHES	175-180
CAS	556-557,810-815	FUSEURS	617-620
CEINTURE PORTE-OUTILS	398	GAMME DE PRODUITS MAT. RECYCLÉ	327-329
CHAISE DE BARBIER	522-526	GANTS	81-83
CHAISE SPÉCIALE POUR ENFANTS	530	GANTS ET ACCESSOIRES	560-561
CHAISES	223	GARDE	81
CHAISES DE BARBIER	230-232,234-237	GAZE ASTRINGENT SKINS LIGNE	590
CHAISES POUR ENFANTS	219-220	GEL ACRYLIQUE	656-657
CHAISES POUR ENFANTS	529	GEL ÉLECTROCONDUCTEU	637
CHARIOT MANUCURE/PEDICURE	830	GEL LES LÉGENDES	516
CHARIOTS	240-242	GLAND	517-519
CHARIOTS ET TAMBOURS	532	GOMMAGE CORPOREL	604
CILS ANDREA SM	769	GRADINS	139-141
CILS COMPLETS ANDREA	770-771	GRANDS FONDEURS	621
CILS POLLIE	763-766	GROUPE DE LAVAGE MONOCOMMANDE	244
CIRE	615-616	HUILE A BARBE	509
		HUILES	436

HUILES DE BASE	601-603	PINCEAUX KABUKI	181-187
HUILES ESSENTIELLES	592-595	PINCES	46-51
HYGIÈNE ET DÉSINFECTANTS	818-821	PINCES À FRISER	640-645
		PINCES ÉPILATION	174
		PINCES ET FOURCHES	385
		PINCES POUR RALLONGES	35-45
KIMONO ANTISTATIQUE	117	PLAQUES	521
KIT BOUCLE CHEVEUX	339	POLO BARBIER	516
KIT CILS ANDREA STARTER	771	POMMADE LES LÉGENDES	500-502
KIT D'EXTENSION	385	POMMADES CAPITAINE COOK	244-536
KIT EXFOLIANT CORPS/VISAGE	604	POMME DE DOUCHE CHROME	243-535
KITS CILS	772	POMME DE DOUCHE IONIQUE	397
KITS D'ÉPILATION POLLIFIÉ	630	PORTE OUTILS NOIR	401
		PORTE PERRUQUE	400
LACLA CASACAS	107-110	PORTE SAC	400
LACLA ETOLES	111-117	PORTE-OUTILS ALUMINIUM	399
LAIT CORPOREL LOTION HYDRATANTE	606	PORTE-OUTILS EN SILICONE	541
LAIT DEMAQUILLANT	579	PORTE-PAPIER BARBIER	504
LAMES	457-459	POUDRE VOLUMINISANTE GRAVITY	268,270-271
LAMPE DE TABLE MANUCURE	830	PRÉSENTOIR À BROSSE	254
LAMPES	673-678	PRÉSENTOIR BOIS 20 BROSSES	774
LAQUE FIBRES CAPILLAIRES	519	PRÉSENTOIR CILS ANDREA	588
LAQUES CAPITAINE COOK	503	PRÉSENTOIR POMPON PROFESSIONNEL	591
LAVE-TÊTES	224-229,527-528	PRÉSENTOIRS HUILES ESSENTIELLES	158-167
LAVEUSES PORTATIVES	238-239	PRODUITS DE FINITION	720
LE RASAGE CO	507-508,510	PROPULSEURS	541
LENDRE PEIGNES/BROSSES BÉBÉ	279	PROTECTEUR D'OREILL	80,567
LES LÉGENDES	516	PROTECTEURS	781-783
LEVIER UNIQUE POUR LAVACESAS	243-535	PROTECTEURS ET GANTS	817
LIGNE ARGAN	146	PROTECTEURS RAYONS UV	541
LIGNE AROMA SENSATION	149-152	PROTECTIONS OCULAIRES	401-403,552-555,816
LIGNE COSMÉTIQUE HYALURONIQUE	581-582	PULVÉRISATEURS	53
LIGNE DE BROSSES IONIQUES	281	RALLONGES DE PINCES DE SOUDAGE	433
LIGNE DE PEIGNES DE BARBIER	491	RASOIR BARBER LINE	434
LIMES ET BLOCS DE POLISSAGE	692-708	RASOIR CAPITAINE COOK	432
LIQUIDE DE TRAITEMENT DES PANSEMENTS FROID	608	RASOIR RAGNAR	638-639
LOTION CAPILLAIRE VITALISANTE	515	RASOIRS	245-537
LOUPES	690-691	RÉDUCTEUR DE DÉBIT D'EAU	774
LUNETTES DE PROTECTION ANTI-BUÉE	791	REMPLACEMENT CAOUTCHOUC BOUCLES CILS	222
		REPOSE-PIEDS EN METAL	352
M. BEAR FAMILLE	509	RÉSEAUX INVISIBLES	497
MACHINES DE COUPE CAPITAINE COOK	422-423	RETOUCHE RACINES RAGNAR	381
MACHINES DE COUPE EUROSTIL	424	RIDEAUX CHEVEUX	102
MACHINES DE COUPE EUROSTIL	424-425	ROBES ET KIMONOS	244,536
MACHINES DE COUPE RAGNAR	416-421	ROBINET D'ÉVIER DE LAVE-TÊTE	336-343
MACHINES DE RETOUCHE CAPITAINE COOK	427-428,431	ROULEAUX	343
MACHINES DE RETOUCHE EUROSTIL	425	SAC À BROCHETTES	385
MACHINES DE RETOUCHE RAGNAR 360°	430	SAC À DISQUES POUR RALLONGES	350
MACHINES DE RETOUCHE RAGNAR	426	SAC CROCHET	759
MALLETES ET CHAISES DE MAQUILLAGE	837-838	SAC D'APPLICATEURS DE FARDS À PAUPIÈRES	385
MANCHE POUR BALAI	410	SAC DE CROCHETS POUR ANNEAUX	384
MANNEQUIN HOMME CHEVEUX NATURELS	210-211	SAC DE RALLONGES CLIPS	476
MASCARA	741	SAVON À RASER SALLE DE BAIN	9-24,438-440
MASQUE HYALURONIQUE	144	SÈCHE-CHEVEUX	33
MASQUE NOIR NETTOYANT EN PROFONDEUR	580	SÈCHE-CHEVEUX CASQUE ORLA	30-31
MASQUE VISAGE	596	SÈCHE-CHEVEUX CASQUES	34
MASQUES FACIAUX	800	SECHOIR CASQUE VALERA	653-655
MASQUES FACIAUX LACLA	801	SEMIPERMS P-LACK	541
MASSAGES MYRSOL	512,514-515	SÉPARATEURS POUR CHEVEUX	404,558-559,784
MÈCHE DE CILS SANS NŒUDS	771	SERVIETTES	203
MÉLANGEUR DE TEINTURE RECHARGEABLE	53	SERVIETTES CELLULOSE ET SPUNLACE	204,780-781
MINUTEURS	62	SERVIETTES SPUNLACE	1874-504
MIROIRS	400,531,566,793-799	SHAMPOING BOURBON	498
MOBILIER ACCUEIL	831	SHAMPOING CAPITAINE COOK	142-143,145,155-157
MOBILIER COMPLÉMENTAIRE	827	SHAMPOING ET MASQUES	141,146-147,153-154
MOUSSE A RASER 4	461	SHAMPOING	517
MYRSOL	512-515	SHAMPOING ANTI-CHUTE DE CHEVEUX	144
		SHAMPOING HYALURONIQUE	651
NETTOYAGE DES BROSSES-PEIGNES	495	SOINS DES ONGLES POLLIE	384
NETTOYAGE ET HYGIÈNE	405-408	SOLVANTS	725-735
NETTOYANT POUR PINCEAUX EN SILICONE	760	SPECIFIQUES PÉDICURE	54-56,443-445,709-710
		STÉRILISATEURS	461
ORGANISATEUR DE SERVIETTES	839	STYLO RASOIR	562
ORGANISATEUR SUSPENDU POUR SERVIETTES	243	SUPPORT	181
ORGANISATEUR SUSPENDU POUR SERVIETTES	535	SUPPORT DE POIGNET MAGNÉTIQUE	25
OSMA	511	SUPPORT SECHE-LINGE	215-573
OXYDANT CAPILLAIRE	132-135	SUPPORTS ET TREPIED	839
		SUSPENSION VENTOUSE	828-829
PACK CAPITAINE COOK	504	TABLES DE MANUCURE	546
PACK CAPITAINE CUISINIER	429	TABLER BARBER LINE	547
PANTALON LACLA	118-119	TABLER CAPITAINE CUISINIER	747
PAPIER DE COU	539-540	TABLER POUR PINCEAUX ET BROSSES	103
PAPIER PERMANENT	204-205	TABLERS	221-222
PAPILLOTS	335	TABOURETS	832-836
PARAFFINE	679	TABOURETS, CHAISES ET SUPPORTS	759
PEAUX BASSES	724	TAILLE-CRAYON	477
PEIGNE A NIVEAUX	280-495	TALC	437
PEIGNE ELECTRIQUE ANTI-POUX	52	TAPIS DE BARBIER RAGNAR	791
PEIGNE EN BOIS	324	TAPIS DE DÉSINFECTION CHAUSSURES	136-138
PEIGNE FOUET EN ACETATE	324	TEINTURE CAPILLAIRE	207-209
PEIGNE SPECIAL MECHEs	350	TÊTE DE MANNEQUIN EN CHEVEUX NATURELS	212-213
PEIGNE SPECIAL	478	TÊTES DE CHEVEUX SYNTHÉTIQUES	572
PEIGNES ACÉTATE	325-326	TÊTES DE MANNEQUIN BARBER LINE	214
PEIGNES ANONYMES	301	TÊTES DE MANNEQUIN BERGMANN	571-572
PEIGNES CAPITAINE COOK	489-490	TÊTES DE MANNEQUIN EUROSTIL	378-379
PEIGNES COULEUR BOIS	320-321	TONDEUSES À CHEVEUX ET RASOIRS	579
PEIGNES DE CARBONE	299-300,493	TONIQUE REVITALISANT	681-682,686-687
PEIGNES DIVERS COULEURS	311-314	TOURS	245-537
PEIGNES EUROSTIL	492	TUBE DE DOUCHE FLEXIBLE EN NYLON	245-537
PEIGNES PEGASUS	304	TUBE DE DOUCHE SOUPLE EN PVC	199
PEIGNES POUR MANCHETTES	322-323	TURBANTS	245-537
PEIGNES PROFESSIONNELS EUROSTIL	287-296,298	TUYAU DE VIDANGE DE LA LAVEUSE	785-791
PEIGNES PROFESSIONNELS MATADOR	307-309		
PEIGNES PROFESSIONNELS POLLIE	305-306	USAGE UNIQUE	388-396
PEIGNES PROFESSIONNELS SILKOMB	310	VALISES ET SACS	597-598
PEIGNES RAGNAR	485-488	VAPEURS ET ACCESSOIRES	33
PEIGNES SILKOMB	494	VAPORISATEUR EUROSTIL	32
PETIT FER BARBER LINE	441	VAPORISATEURS CERIOTTI	244-536
PIÈCES DE RECHANGE POUR TOURS	688-689	VASQUE DE DOUCHE NOIRE	74
PIÈCES DE RECHANGE TOURS	684	VASQUES ET COUVERCLES DE LAVABO	548-551
PIECES DETACHEES TOURS MANUCURE	683	VÊTEMENTS HOMME LACLA	802-807
PINCE COUPE CUTICULES	711	VÊTEMENTS/UNIFORMES LACLA	
PINCE COUPE CUTICULES	712-715,717		
PINCE COUPE-ONGLES	711		
PINCE COUPE-ONGLES	716		
PINCE EN ACIER INOXYDABLE. USAGE GÉNÉRAL	784		
PINCEAU BLUSH ANGULAIRE	747		
PINCEAUX DE MAQUILLAGE POLLIFIÉ	748		
PINCEAUX ET PINCEAUX DE MAQUILLAGE PINCEAUX	749-751,754		
GEL ET ACRYLIQUE	661-662		
	752-753		

ACESSÓRIOS	817	CONJUNTO DE BARBEAR BARBER LINE	478
ACESSÓRIOS CERA	622-623	CONJUNTO DE DUCHE ADAPTÁVEL	243.535
ACESSÓRIOS DE ART DE UNHAS	663-673	CONJUNTO DE DUCHE E ALAVANCA ÚNICA	536
ACESSÓRIOS DE CERA ROLL-ON	628-629	CONTADORES E ESPELHOS	217-218
ACESSÓRIOS DE COSMÉTICOS	609	COQUETADORES E 75 METROS	75
ACESSÓRIOS DE COSMÉTICOS	680	CORANTE DE COR BRILHANTE	121-132
ACESSÓRIOS DE MANICURE	721	CORREIA PORTA-FERRAMENTAS	398
ACESSÓRIOS DE TORNO	685	CORTADOR DE CABELO	377
ACESSÓRIOS E KITS POLLÍE	652	CORTADOR DE UNHAS	718
ACESSÓRIOS TINT	59-60	CORTADOR DE UNHAS ARTIFICIAL	718
ADESIVO PARA FIXAR CORTINAS DE CABELO	384	CORTINAS DE CABELO	381
ADESIVOS PARA CÍLIOS	773	COSMÉTICOS POS DEPILAÇÃO	634-635
AFIADOR DE LÁPIS	759	CREME CAPTAIN COOK	499
ÁGUA MICELAR	580	CREME DE CACHOS ROCK	503
AGULHAS ELÉTRICAS	636	CREME PARA AS MÃOS	660
ALAVANCA ÚNICA PARA LAVACESAS	243.535	CREMES CAPTAIN COOK	505
ALGODÃO	387.791-792	CREMES E TRATAMENTOS	583-585.587.589
ALICATES	181-187		
ALICATES DE CORTE DE CUTÍCULAS	711	DELINEADOR DE OLHOS	741
ALICATES DE CORTE DE CUTÍCULAS	712-715.717	DESINFECTANTE, ESTERILIZADORES	563-565
ALICATES DE CORTE DE UNHAS	711	DIFUSORES	26-27
ALICATES DE CORTE DE UNHAS	716	DISTRIBUIDOR	80
ALICATES PARA EXTENSÕES	385	DISTRIBUIDOR DE PENTE UM USO	297
ALMOFADAS ESPECIAIS PARA CRIANÇAS	220.530	DISTRIBUIDORES	409
ANÉIS	382	DISTRIBUIDORES DE GEL	568
ANTI-CELULITE E FIRME	605	DUCHE COM APOIO	243.535
APARADORAS DE CABELO E LÂMINAS	378-379	DUCHE COM APOIO LAVACAZEZAS	244.536
APOIO DE PÉ DE METAL	222		
APOS-BARBA	508	EMBALAR CAPTAIN COOK	429
APOS-BARBA MYRSOL	513	EMULSÃO DE BARBEAR SEM ÁLCOOL	513
ARCO RECHEADO	353-357	ENROLAR BANDEJAS FRIAS	608
ARQUIVOS	139-141	ESCADA DE MADEIRA SPA	826
ARRUELAS PORTÁTEIS	238-239	ESCALAS	62-63
AS LEGENDAS	516	ESCOVA ANGULAR	747
ASPERORES	68-73	ESCOVA CIRCULAR	286
ASPIRADOR DE CABELO	57.442	ESCOVA CIRCULAR DE MADEIRA	249-251
ATIVADORES	28-29	ESCOVA CIRCULAR DE PLÁSTICO	249
ATOMIZADOR DE FIBRA CAPILAR	518	ESCOVA DE BARBA RAGNAR	478
AVENTAL	103	ESCOVA DE DESEMBARAÇAR	267
AVENTAL CAPTAIN COOK	547	ESCOVA DE FOLE COM CABO DE MADEIRA	252
AVENTAL DE LINHA DE BARBEIRO	546	ESCOVA DE FOLE COM CABO DE PLÁSTICO	258-263
AVENTAL PARA ESCOVAS E PINCEIS	747	ESCOVA DE LINHA DE BARBEIRO	479
		ESCOVA DE MADEIRA COM CABO DE BORRACHA	252
BACIA DE DUCHE PRETA	244.536	ESCOVA DE SHAMPOO MASSAGER	319
BALCOES DE RECEPÇÃO E OUTROS	533-534	ESCOVA DESEMBARAÇAR FOLAS	257
BÁLSAMO DE BARBA	509	ESCOVA ELÉTRICA TÉRMICA	52
BÁLSAMO DE BIGOD	509	ESCOVA ESFÉRICA 3D	269
BANCOS	221-222	ESCOVA PROFISSIONAL OVAL	259
BANHEIRO SABÃO DE BARBEA	476	ESCOVA RAGNAR	481
BANQUETES, CADEIRAS E SUPORTES	832-836	ESCOVA TÉRMICA	286
BARBEADOR CAPTAIN COOK	434	ESCOVAS	476
BARBEADOR RAGNAR	432	ESCOVAS	759
BARBEADORES	638-639	ESCOVAS	784
BARBEIRO POLO	521	ESCOVAS COM CABO DE MADEIRA	755-757
BARBER LINE BARBEADORA	433	ESCOVAS DE BAMBUI	255
BICOS EUROSTIL	435	ESCOVAS DE BARBEIRO	475
BLISTERS DE PREVENÇÃO DE QUEDAS	517	ESCOVAS DE CABO DE MADEIRA DE FOLE	253-254.256
BOLES	64-67	ESCOVAS DE CREPE	247
BOLSA APLICADORA DE SOMBRA	759	ESCOVAS DE ESQUELETO	272-276
BOLSA DE CROCHÉ	350	ESCOVAS DE EXIBIÇÃO 7	758
BORRACHA E LAÇOS	192-198	ESCOVAS DE FOLE COM CABO DE BORRACHA	264-265
BRAÇADEIRA DE AÇO INOX. USO GERAL	784	ESCOVAS DE LIMPEZA	495
		ESCOVAS DE LINHA DE BARBEIRO	480-481
CABEÇA DE MANEQUIM DE CABELO NATURAL	207-209	ESCOVAS ESPIRAIS	248
CABEÇAS DE CABELO SINTÉTICOS	212-213	ESCOVAS EUROSTIL	482-483
CABEÇAS DE MANEQUIM BERGMANN	214	ESCOVAS KABUKI	752-753
CABEÇAS DE MANEQUIM EUROSTIL	571-572	ESCOVAS PARA FERRO	278
CABEÇAS DE MANEQUIM LINHA DE BARBEIRO	572	ESCOVAS PLANAS DESEMBARAÇADO	277
CABELOS DE MADEIRA	331	ESCOVAS PNEUMÁTICAS	266
CABO PARA VASSOURA	410	ESCOVAS RAGNAR	479
CACHOS CÍLIOS	774	ESCOVAS TÉRMICAS	283-284
CADEIRA DE BARBEIRO	522-526	ESCOVAS TÉRMICAS DE ALUMÍNIO	285
CADEIRA ESPECIAL PARA CRIANÇAS	530	ESCOVAS TÉRMICAS CERÂMICAS	282
CADEIRAS	223	ESCOVAS TÉRMICAS IÔNICAS	282
CADEIRAS DE BARBEIRO	230-232.234-237	ESFOLIAÇÃO CORPORAL	604
CADEIRAS DE CABELEIREIRO	233	ESFOLIANTE FACIAL	580
CADEIRAS PARA CRIANÇAS	219-220	ESMALTE P-LACK	653-655
CADEIRAS PARA CRIANÇAS	529	ESMALTE POLLÍE	647-651
CAIXA DE ESPELOS	343	ESPECÍFICOS PEDICURE	725-735
CAIXA DE PINCEIS DE MAQUIAGEM	760-761	ESPELHOS	400.531.566.793-799
CAIXA ORGANIZADORA (VAZIA)	399	ESPONJAS DE MAQUIAGEM	744-746
CALÇAS LACLA	118-119	ESPONJAS KONJAC	599
CAMADAS	90-101.543-545	ESPONJAS RETIRADORAS DE MAQUIAGEM	742-743
CANA DE MASSAGEM VIBRATÓRIA	607	ESPUMA DE BARBEAR	461
CANETA LÂMINA	461	ESTERILIZADORES	54-56.443-445.709-710
CANIVETES CAPTAIN COOK	453-454	ESTOLAS LACLA	111-117
CANIVETES E LÂMINAS PARA PENAS	456	EUROSTIL VAPORIZADOR 3	33
CANIVETES EUROSTIL	455	EXIBIÇÃO DE CÍLIOS ANDREA	774
CANIVETES LINHA DE BARBEIRO	449-452	EXIBIR CELULAS ATIVAS DE TASSEL	586
CANIVETES POLLÍE PARA SOBRANCELHA	775	EXIBIR FIBRAS DE CABELO	519
CAPA DE CORTE CAPTAIN COOK	547	EXPOSIÇÃO DE BORELA PROFISSIONAL	588
CAPAS DE USO ÚNICO	86-89	EXPOSITO DE MADEIRA 20 PINCEIS	254
CAPAS E MACA DE PAPEL	777	EXPOSITORES	740
CAPAS INFANTIS	104-105	EXTENSÕES DE AMOSTRA DE CORES	385
CAPITÃO BARBEIRO TAPETE	437	EXTENSÕES DE PINÇA DE SOLDAGEM	53
CAPTAIN COOK	498-504	EXTENSÕES DE SACO DE CLIPES	384
CAPTAIN COOK ÓLEOS	505		
CAPTAIN COOK DE CERA	505	FACAS DE BOLSO RAGNAR	447-448
CAPS	344.346-349.351	FACAS DESCARTÁVEIS	460
CARRINHO DE MANICURE/PEDICURE	830	FAIXA DE CÍLIOS SEM NÓS	771
CARRINHOS	240-242	FAIXAS DE DEPILAÇÃO	631-633
CARRINHOS E TAMBOR	532	FAMÍLIA SR.URSO	509
CASOS	556-557.810-815	FIBRAS DE CABELO	164.518
CASOS DE PENTE	302-303	FIBRAS DE CABELO DE LACA	519
CASOS DE TESOURA	374-376	FIXAÇÃO DE EFEITO SECO	502
CERA	615-616	FOLHA DE ALUMÍNIO	77-79
CHUVEIRO CROMADO	244.536	FORMATO DE CERA KG	611-614
CHUVEIRO IÔNICO	243.535	FORMATO DE CERA ROLL-ON	624-627
CILINDRO PARA ESCOVAS E ESCOVAS	747	FRASCOS DE APLICADOR GRADUADO	76
CÍLIOS CHEIOS ANDREA	770-771	FUSADORES	617-620
CLIPES	169-173.383	FUSOR DE CERA PRETA BARBER LINE	441
CLIPES COM PÉROLAS	200-201		
CLIPES E GARFOS	174	GANCHO DE PENTE DE METAL MECHAS	350
COBERTURAS E TOALHAS	778-779	GANCHOS DE SACO MECHAS	350
COBERTURAS PARA CORTE DE UNHAS E ÓCULOS	719	GARFOS	175-180
COMBINAÇÕES HEMOSTÁTICAS	516	GEL ACRÍLICO	656-657
COMBOS EUROSTIL	492	GEL AS LEGENDAS	516

GEL ELETROCONDUTIVO	637	PENTEADOS E CAPAS	542
GRAMPOS	189-191	PENTEADOS PROFISSIONAIS EUROSTIL	287-296,298
GRAMPOS E GRAMPOS	188	PENTES LENDRE/ESCOVAS PARA BEBÊ	279
GRANDES DERRETIDORES	621	PENTES PROFISSIONAIS MATADOR	307-309
GUARDA	81	PENTES PROFISSIONAIS POLLIE	305-306
		PESTANAS ANDREA	767-768
HIGIENE E DESINFECTANTES	818-821	PESTANAS ANDREA SM	769
HOMEM MANEQUIM CABELO NATURAL	210-211	PINÇA ALICATES	640-645
HOMENS DE CERA ROLL-ON	519	PINÇAS DE CURLING	46-51
		PINÇEIS DE MAQUIAGEM POLLIE	748
KIT DE CABELO	339	PINÇEIS E PINÇEIS DE MAQUIAGEM	749-751,754
KIT DE CILHAS ANDREA STARTER	771	PINÇEIS GEL E ACRILICO	661-662
KIT DE EXTENSÃO	385	PLACAS	35-45
KIT ESFOLJANTE CORPORAL/FACIAL	604	PÓ VOLUMINIZADOR GRAVITY	504
KITS DE CÍLIOS	772	POLLIE PESTANAS	763-766
KITS DE DEPILAÇÃO POLLIE	630	POMADAS AS LEGENDAS	516
		POMADAS CAPTAIN COOK	500-502
LACAS CAPTAIN COOK	503	PORTA-CARTÕES DE ALUMÍNIO	400
LACLA CASACAS	107-110	PRODUTOS DE ACABAMENTO	158-167
LÂMINAS	457-459	PROPULSOR	720
LÂMPADA DE MESA DE MANICURE	830	PROTETOR DE ORELHA	541
LÂMPADAS	673-678	PROTETOR FACIAL	400
LÁPIS DE MADEIRA POLLIE	739	PROTETOR FACIAL FACEPRO	399
LÁPIS DE PLÁSTICO POLLIE	737	PROTETORES	80,567
LÁPIS PARA OLHOS DE MADEIRA POLLIE	738	PROTETORES DE RAIOS UV	817
LÁPIS PARA SOBRANCELHAS DE MADEIRA POLLIE	740	PROTETORES E LUVAS	781-783
LAVADORES DE CABEÇA	224-229,527-528	PROTETORES OCULARES	541
LAVATÓRIOS E TAMPAS DE LAVATÓRIO	74	PULVERIZADORES	401-403,552-555,816
LEITE DE LIMPEZA	579		
LIMAS E BLOCOS DE POLIMENTO	692-708	QUIMONO ANTIESTÁTICO	117
LIMPADOR DE ESCOVAS DE SILICONE	760		
LIMPEZA E HIGIENE	405-408	RECEPÇÃO DE MÓVEIS	831
LIMPEZA PROFUNDA DE MÁSCARA PRETA	580	RECIPIENTE DE TOALHAS	535,839
LINHA ARGAN	146	RECIPIENTE PARA TESOURAS	377
LINHA COSMÉTICA HIALURÔNICA	581-582	REDE SECADORA TRIANGULAR	345
LINHA DE BARBEIRO DE FERRO PEQUENO	441	REDES INVISÍVEIS	352
LINHA DE ESCOVAS IÔNICAS	281	REDUTOR DE FLUXO DE ÁGUA	245,537
LINHA DE PELE DE GAZE ADSTRINGENTE	590	REMOVEDOR DE POLO	658-660
LINHA DE PENTE DE BARBEIRO	491	RETOQUE DE RAIZ RAGNAR	497
LINHA DE PRODUTOS MAT. RECICLADO	327-329	RETOQUE DE RAÍZES DO EXPOSITOR RAGNAR	497
LINHA DE SENSAÇÃO DE AROMA	149-152	RETOQUES DE PLÁSTICO	332-334
LINHAS	772	ROLLOS	336-343
LÍQUIDO DE TRATAMENTO DE BANDAGEM FRIO	608	ROUPA MASCULINA LACLA	548-551
LOÇÃO CAPILAR VITALIZANTE	515	ROUPAS E KIMONOS	102
LOÇÃO HIDRATANTE CORPORAL LEITE	606	ROUPAS/UNIFORMES LACLA	802-807
LUPAS	690-691		
LUVAS	81-83	SACO DE DISCO PARA EXTENSÕES	385
LUVAS E ACESSÓRIOS	560-561	SACO DE ESPETOS	343
LUZ DE ANEL DE LED	808-809	SACO DE GANCHOS PARA ANÉIS	385
		SECADOR DE CAPACETE ORLA	33
MAÇAS	823-826	SECADOR DE CAPACETE VALERA	34
MALAS E BOLSAS	388-396	SECADORES	9-24,438-440
MALAS E CADEIRAS DE MAQUIAGEM	837-838	SECADORES DE CAPACETE	30-31
MÁQUINAS DE CORTE CAPTAIN COOK	422-423	SEPARADORES PARA CABELO	541
MÁQUINAS DE CORTE EUROSTIL	424	SHAMPOO	141,146-147,153-154
MÁQUINAS DE CORTE EUROSTIL	424-425	SHAMPOO BOURBON 1874	1874,504
MÁQUINAS DE CORTE RAGNAR	416-421	SHAMPOO CAPTAIN COOK	498
MÁQUINAS DE RETOQUE CAPTAIN COOK	427-428,431	SHAMPOO CAPTAIN COOK	499
MÁQUINAS DE RETOQUE EUROSTIL	425	SHAMPOO DE PREVENÇÃO DA QUEDA DE CABELO	517
MÁQUINAS DE RETOQUE RAGNAR 360°	430	SHAMPOO E MÁSCARAS	142-143,145,155-157
MÁQUINAS DE RETOQUE RAGNAR	426	SHAMPOO HIALURÔNICO	144
MÁSCARA	741	SOBRANCELHAS ANDREA	775
MÁSCARA FACIAL	596	SOLVENTES	384
MÁSCARA HIALURÔNICA	144	SUBSTITUIÇÃO DE BORRACHA CURLS PESTANAS	774
MÁSCARAS FACIAIS	800	SUPORTE DE FERRAMENTA DE SILICONE	399
MÁSCARAS FACIAIS LACLA	801	SUPORTE DE FERRAMENTA PRETO	397
MISTURADOR DE TINTURA RECARREGÁVEL	53	SUPORTE DE PAPEL DE PESCOÇO	541
MOSTRA CAPTAIN COOK	506	SUPORTE DE PERUCA	401
MOSTRA ÓLEOS ESSENCIAIS	591	SUPORTE DE SACO	400
MOSTRADORES DE ESCOVAS	268,270-271	SUPORTE DE SECADOR	25
MOstrar TESOURA	377	SUPORTE DE VENTILADOR	839
MÓVEIS COMPLEMENTARES	827	SUPORTE MAGNÉTICO DE PULSO	181
MYRSOL	512-515	SUPORTES E TRIPE	215,573
MYRSOL MASSAGES	512,514-515		
		TABELAS DE MANICURE	828-829
NAVALHAS DE BOLSO DESCARTÁVEIS POLLIE	377	TALC	477
		TAPETE DE BARBEARIA RAGNAR	437
O BARBA CO	507-508,510	TAPETE DE DESINFECÇÃO CALÇADO	791
ÓCULOS DE PROTEÇÃO ANTI-NEVOEIRO	791	TASSEL	517-519
ÓLEO DE BARBA	509	TEMPORIZADORES	62
ÓLEOS	436	TESOURA CAPTAIN COOK	466-468
ÓLEOS DE BASE	601-603	TESOURA DE INICIAÇÃO	372,472
ÓLEOS ESSENCIAIS	592-595	TESOURA DE INICIAÇÃO	373
ORGANIZADOR DE TOALHA	243	TESOURA DE LINHA DE BARBEIRO	463,469
ORGANIZADOR DE TOALHAS	535	TESOURA DE TITÂNIO E DECORADA	359-360
ORGANIZADOR DE TOALHAS	839	TESOURA ESPECIAL DA ACADEMIA	373
OSMA	511	TESOURA ESPECIAL PARA CANHOTOS	473
OXIDADOR CAPILAR	132-135	TESOURA ESQUERDA	366
		TESOURA EUROSTIL	470-471
PAQUETE DE BARBA CAPTAIN COOK	504	TESOURA LÂMINA LÂMINA	366
PAQUETE DE CABELO CAPTAIN COOK	504	TESOURA PARA PELE E UNHAS	722-723
PAPEL DE PESCOÇO	539-540	TESOURA PROFISSIONAL	361-365,367-372
PAPEL PERMANENTE	204-205	TESOURA RAGNAR	464-465
PAPILOTES	335	TINTURA DE CABELO	136-138
PARAFINA	679	TIRA MECAS	61-62
PEÇAS DE REPOSIÇÃO PARA TORNOS	688-689	TITULAR	562
PEÇAS SOBRESSALENTES TORNOS DE MANICURE	683	TOALHAS	404,558-559,784
PELE BAIXA	724	TOALHAS DE CELULOSE E ESPUNHACE	203
PENTE AFOFO DE MADEIRA	324	TOALHAS DE ESPUNHACE	204,780-781
PENTE CAPTAIN COOK	489-490	TÔNICO REVITALIZANTE	579
PENTE COLORIDO DE LATAS	315-319	TORNOS	681-682,686-687
PENTE COM NÍVEIS	280,495	TORNOS DE PEÇAS DE REPOSIÇÃO	684
PENTE DE ACETATO	325-326	TRATAMENTOS DE UNHAS POLLIE	651
PENTE DE BACIA DE CASCO DE ACETATO	324	TUBO DE DRENAGEM DA ARRUELA	245,537
PENTE DE BARBA ESPECIAL	478	TUBO DE DUCHE DE NYLON FLEXÍVEL	245,537
PENTE DE CARBONO	299-300,493	TUBO DE DUCHE DE PVC FLEXÍVEL	245,537
PENTE DE COR DE MADEIRA	320-321	TURBANTES	199
PENTE DE CUNHA	322-323		
PENTE DE PEGASUS	304	UNIDADE DE LAVAGEM DE ALAVANCA ÚNICA	244
PENTE DE SILKOMB	494	USO ÚNICO	785-791
PENTE DE VÁRIAS CORES	311-314		
PENTE ELÉTRICO ANTI-PIOLHOS	52	VÁLVULA DO LAVADOR DE CABEÇA	244,536
PENTE ESPECIAL MEUS	350	VAPOR E ACESSÓRIOS	597-598
PENTE PROFISSIONAL SILKOMB	310	VAPORIZADORES CERIOTTI	32
PENTE RAGNAR	485-488	VAISSOURAS	569
PENTEADORES	84-85	VAISSOURAS DE BORRACHA	410
PENTEADOS ANÔNIMOS	301		



C/Ciudad de Asunción 56 · Barcelona 08030 (Spain)  
Tel. +34 93 274 07 84  
ventas@eurostil.com · export@eurostil.com