

KATALOG / CATALOGO

**2021**

**Friseur**

PARRUCCHIERI

**EURO** *cut*

**TASSEL**  
ESTÉTICA · BARBERÍA · PELUQUERÍA

**Barbershop**

BARBER

*Barber Line* **RAGNAR**  
ESTÉTICA · BARBERÍA · PELUQUERÍA

**Ästhetik**

ESTÉTICA

**Pollié**   
FARMACIA · ESTÉTICA · BARBERÍA

**TASSEL**  
ESTÉTICA · BARBERÍA · PELUQUERÍA

## **Große Erfahrung schafft großartige Qualitätsprodukte** **Grandi esperienze creano prodotti di grande qualità**

Industrias Oriol wurde 1942 von Herrn Narciso Oriol Quintana in Barcelona gegründet. Es handelt sich um ein Familienunternehmen, das nach und nach wuchs, Erfahrungen sammelte und sich in der Herstellung und im Vertrieb von Produkten aus der ganzen Welt verbesserte und sich als eines der besten und anerkanntesten Unternehmen des Sektors positionierte. Sie exportiert derzeit in die fünf Kontinente und hat eine Niederlassung in Buenos Aires, Argentinien. All diese Bemühungen wurden von einem schwindelerregenden Wachstum gekrönt, das sie dazu veranlasste, ihre Einrichtungen zu erweitern und zu modernisieren. Sie verfügt derzeit über eine moderne Fabrik, ein großes Lager und geräumige Büros auf einer Gesamtfläche von mehr als 16.000 m<sup>2</sup> in Barcelona. Das Unternehmen hat mehrere Abteilungen für um die notwendigen Produkte entwickeln zu können, die der Friseur, Barbier und Ästhetiker benötigt, wie z.B.: Herstellung von Kosmetika, Metallumformung, Kunststoff einspritzung, Gummi- und Silikon einspritzung, Metallbearbeitung, Herstellung aller Arten von Bürsten; Handhabung von Papier und Verpackung sowie eine Design- und Forschungsabteilung. Um eine breitere Produktpalette anbieten zu können, haben wir weitere Marken von nationalem und internationalem Prestige in unseren Katalog aufgenommen, wie zum Beispiel:

PANASONIC, MYRSOL, MR BEAR FAMILY, CAPTAIN COOK, PEN RAZOR, ELIOS, LACLA, ETC.

In diesem neuen Katalog möchten wir mit Ihnen die letzten Neuigkeiten teilen, ohne unsere üblichen Artikel zu vergessen. Wir arbeiten daran, Ihnen die Qualität zu bieten, die Sie benötigen. Wir wollen an Ihrer Seite sein. Erfahrung zählt! Wir sind davon überzeugt, dass große Erfahrung großartige Produkte hervorbringt. Industrias Oriol setzt sich seit Jahren für die soziale Verantwortung von Unternehmen ein, indem es in verschiedenen Projekten für Sozialhilfe und soziale Integration mitarbeitet und die Strategie des Kreislaufes für Nachhaltigkeit und Energieeinsparung umsetzt.

*Industrias Oriol fu creata nel 1942 da Don Narciso Oriol Quintana a Barcellona come un'azienda familiare che si sviluppò pian piano, acquisendo esperienza e migliorando la produzione e la distribuzione di prodotti da tutto il mondo, diventando una delle aziende migliori e più riconosciute del settore. Attualmente esporta in cinque continenti e ha una filiale a Buenos Aires, in Argentina. Tutto questo impegno è stato coronato da una crescita vertiginosa che l'ha portata ad ampliare e modernizzare le proprie strutture. Attualmente dispone di uno stabilimento moderno, un vasto magazzino e ampi uffici, che coprono un'area totale di oltre 16.000 m<sup>2</sup> a Barcellona.*

*L'azienda dispone di diversi reparti per essere in grado di sviluppare i prodotti necessari richiesti dai professionisti dell'acconciatura, dai barbieri e dagli estetisti professionisti come: produzione di cosmetici, stampaggio, iniezione di plastica, iniezione di gomma e silicone, metallurgia, produzione di tutti i tipi di spazzole, lavorazione della carta e del tessuto non tessuto, marcatura, packaging, nonché un dipartimento di progettazione e ricerca. Per offrire una gamma più ampia di prodotti, abbiamo introdotto nel nostro catalogo altri marchi di prestigio nazionale ed internazionale, come:*

*PANASONIC, MYRSOL, MR BEAR FAMILY, CAPTAIN COOK, PEN RAZOR, ELIOS, LACLA, ECC.*

*In questo nuovo catalogo, vogliamo condividere con voi le ultime novità senza dimenticare i nostri articoli classici. Lavoriamo per offrirvi la qualità di cui hai bisogno. Vogliamo essere al tuo fianco. L'esperienza conta! Siamo convinti che le grandi esperienze creano ottimi prodotti.*

*Industrias Oriol è impegnata da anni nella Responsabilità Sociale d'Impresa, collaborando a diversi progetti di assistenza e integrazione sociale, oltre a realizzare una strategia di economia circolare pensata per la sostenibilità e il risparmio energetico.*



## Familienunternehmen Azienda familiare



Nach mehr als 78 Jahren Geschichte ist die dritte Generation der Familie in das Unternehmen eingetreten und bringt neue Ideen, Projekte und Begeisterung in das Wachstum und die Konsolidierung des Unternehmens ein.

Eine Familie, die ihre Kräfte zusammenhält und zusammen kämpft, in einem gemeinsamen Projekt, das aus der Illusion von Don Narciso Oriol Quintana entstanden ist, der es von Generation zu Generation weiterzugeben wusste.

Tatsache ist auch, dass vor mehr als 10 Jahren die Tochtergesellschaft in Buenos Aires, Argentinien, unter dem Namen EUROSTIL ARGENTINA S.A. eröffnet wurde. Sie produzieren und verkaufen hochwertige Produkte für den lateinamerikanischen Markt. Es wurden Barrieren abgebaut und der Markt erweitert.

Dies ist die Unternehmens- und Familienphilosophie, die das Resultat einer 78 Jahre lang gut gemachter Arbeit ist.

Mit der Hilfe aller ist Industrias Oriol zu einer großen Familie geworden. Wir arbeiten weiterhin daran, auf dem Markt eine Referenz für Qualität, Leistung und Design zu sein.

Danke für Ihr Vertrauen!

*Dopo più di 78 anni di storia, la terza generazione della famiglia è entrata in azienda, contribuendo con nuove idee, progetti ed entusiasmo alla crescita e al consolidamento dell'azienda.*

*Una famiglia che unisce gli sforzi e si impegna in un progetto comune nato dall'illusione di Narciso Oriol Quintana, che ha saputo tramandarlo di generazione in generazione.*

*È un dato di rilievo anche l'apertura della filiale a Buenos Aires, Argentina, con il nome EUROSTIL ARGENTINA S.A., che produce e commercializza prodotti di alta qualità per il mercato latinoamericano. Apertura dei confini ed espansione del mercato.*

*Questa è la filosofia aziendale e familiare, che nasce dal risultato di un lavoro ben fatto sviluppato per 78 anni.*

*Con l'aiuto di tutti, Industrias Oriol è diventata una grande famiglia. Continuiamo a lavorare per essere un punto di riferimento nel mercato, per qualità, prestazioni e design.*

*Grazie per la vostra fiducia*



**Es ist wichtig, eine gute Organisation zu haben**  
**È importante essere ben organizzati**



1



2



3



4



5



**Lernen Sie uns mit diesem Video besser kennen!**  
**Conoscici meglio con questo video!**

1. Büros · Uffici
2. Designabteilung · Dipartimento di progettazione
3. Abteilung für Bürsten · Sezione spazzole
4. Kunststoff-Spritzerei · Sezione iniezione plastica
5. Abteilung für Papier · Sezione carta

**Technischer Kundendienst**  
**Assistenza tecnica**



Bei Industrias Oriol bieten wir Ihnen unsere technische Serviceabteilung an, die sich der Reparatur und Behebung von Fehlern oder Funktionsstörungen widmet, die bei einem unserer Elektrogeräte aufgetreten sein könnte. Mit der Schaffung dieser Abteilung beabsichtigen wir, den Service zu verbessern, effizienter zu sein und die Zeit bei möglichen Reparaturen unserer Produkte zu verkürzen. Diese werden intern mit Fachpersonal durchgeführt. Unser Ziel ist es, unseren Kunden bessere Dienstleistungen anzubieten. Wenn Sie weitere Informationen über unseren technischen Dienst benötigen, zögern Sie nicht, uns zu kontaktieren.

*In Industrias Oriol mettiamo a tua disposizione l'ufficio dell'assistenza tecnica, pensato per riparare e risolvere qualsiasi guasto o malfunzionamento che potrebbe verificarsi in uno dei nostri apparecchi elettrici. Con la creazione di questo reparto intendiamo migliorare il servizio, essere più efficienti, velocizzando i tempi nelle eventuali riparazioni dei nostri prodotti. Queste vengono svolte internamente con personale specializzato. Il nostro obiettivo è offrire servizi migliori ai nostri clienti. Se hai bisogno di maggiori informazioni sul nostro servizio tecnico, non esitare a contattarci.*

**Kosmetiklabor und Herstellung**  
**Laboratorio e produzione cosmetica**



Industrias Oriol verfügt dank einer modernen und automatisierten Kosmetikfabrik auch über ein Labor, das sich der Forschung, Entwicklung und Herstellung neuer Produkte im Bereich Kosmetik widmet.

Die Marke TASSEL COSMETICS wurde neu geschaffen, um unseren Kunden qualitativ hochwertige Produkte im Bereich der Haar-, Körper- und Gesichtskosmetik anzubieten.

Unser Ziel ist es, dass sie den Unterschied bemerken. Die Inhaltsstoffe und Zusammensetzung werden sorgfältig geprüft und ausgewählt. Alle unsere Produkte sind im Gesundheitsministerium und im Portal der neuen europäischen Kosmetikverordnung registriert.

*In Industrias Oriol abbiamo anche un laboratorio dedicato alla ricerca, sviluppo e produzione di nuovi prodotti in ambito cosmetico, grazie ad una moderna ed automatizzata fabbrica di cosmetici.*

*Il nuovo marchio, TASSEL COSMETICS, è stato creato per offrire ai nostri clienti prodotti di alta qualità nei cosmetici per capelli, corpo e viso.*

*Il nostro obiettivo è farti notare la differenza. Ingredienti e formule vengono accuratamente testati e selezionati. Tutti i nostri prodotti sono registrati presso il Ministero della Salute e sul Portale del Nuovo Regolamento Europeo sui Cosmetici.*

## Einfach zu bestellen Fai il tuo ordine in modo facile



Sie können bequem bestellen, wo und wie Sie wollen: über das Web (B2B), per Telefon, per Post... B2B ist jetzt auch für Handys und Tablets geeignet, so dass Sie bequem und einfach mit jedem Gerät bestellen können, wo auch immer Sie sind.

*Puoi ordinare comodamente da dove vuoi e come vuoi: attraverso il nostro sito web (B2B), per telefono, via mail... Ora il B2B si adatta a cellulari e tablet in modo da poter effettuare gli ordini comodamente e facilmente con qualsiasi dispositivo, ovunque ti trovi.*



Die Mindestbestellmenge beträgt 500 Euro (GERMANY) und die Mindestverkaufseinheit für jedes Produkt ist im Katalog angegeben. Rücksendungen werden nur innerhalb von 60 Tagen nach Erhalt der Ware akzeptiert, mit ausdrücklicher Zustimmung von Industrias Oriol.

*L'ordine minimo è di 500€ (ITALY) e l'unità minima di vendita per ogni prodotto è indicata nel catalogo. I resi saranno accettati solo entro 60 giorni dal ricevimento della merce, previo espresso consenso di Industrias Oriol.*



Um die Abarbeitung Ihrer Bestellung zu beschleunigen, ist es wünschenswert, die Beschreibung des Produkts oder eines Teils davon, die Referenz und die Menge jedes Produkts deutlich anzugeben.

*Per velocizzare la preparazione del tuo ordine, indica chiaramente il código dell'articolo o e la quantità di ogni prodotto, è inoltre conveniente inserire la descrizione del prodotto o parte di esso.*



Für Fracht vorausbezahlt, Für ganz Deutschland 2500€. Für andere Länder wenden Sie sich bitte an die Exportabteilung (export@eurostil.com).

*Affinché le spese di spedizione siano pagate, deve essere effettuato un importo di ordine pari o superiore a 1000€ (taxes esclusa) Per altri paesi, consultare l'Ufficio Esportazioni (export@eurostil.com).*



Wenn Sie zusätzliche oder detailliertere Informationen zu einem Produkt benötigen, können Sie uns unter info@eurostil.com kontaktieren oder uns unter 93 274 07 84 anrufen. Wir helfen und beraten Sie gerne bei der Auswahl des besten Produkts.

*Se hai bisogno di informazioni aggiuntive o più dettagliate su un prodotto puoi contattarci via mail a info@eurostil.com o chiamaci al numero +34 93 274 07 84 Saremo felici di aiutarti e consigliarti sulla migliore scelta del prodotto.*

### Ikonen · Icone



Mindestverkaufseinheit  
*Unità minima di vendita*



Einheiten pro Box  
*Unità per confezione*



Gestaffelter Preis  
*Prezzo scalato*



Feine Spitze  
*Punta fine*



Flache Spitze  
*Punta piatta*



Dachförmige Spitze  
*Punta testa*



Schräge Spitze  
*Punta obliqua*



Nylon Zinken  
*Punte in nylon*



Kunststoff-Borsten  
*Punte in plastica*



Wildschweinborsten  
*Setole di cinghiale*



Hölzerne Borsten  
*Punte in legno*



Metall-Zinken  
*Punte in metallo*



# Besondere Friseur

## SPECIALE PER PARRUCCHIERI

Pollié

lacla

Ondina

ETI

PEGASUS

Lerlotti

TRAMUNTANA

MEDITERRÁNEO

SILCOMB

BERGMANN  
HAIR AND MORE...

MATADOR  
PROFESSIONAL

Valera

REMINGTON

## 01 Elektrogeräte Articoli elettrici 8

Trockner · <i>Asciugacapelli</i> .....	9
Diffusoren · <i>Diffusori</i> .....	22
Thermische Aktivatoren · <i>Caschi e lampade a termostimolazione</i> .....	24
Haubentrockner, Dampfhaube Cerotti <i>Casco asciugacapelli, Vaporizzatore Cerotti</i> .....	25
Haubentrockner, Dampfhaube Eurostil <i>Casco asciugacapelli, Vaporizzatore Eurostil</i> .....	27
Valera Haubentrockner · <i>Casco asciugacapelli Valera</i> .....	28
Glätteisen · <i>Piastre</i> .....	29
Lockenstäbe · <i>Arriciacapelli</i> .....	39
Farbstoffmischer · <i>Miscelatore per tintura</i> .....	45
Sterilisatoren · <i>Sterilizzatori</i> .....	46
Staubsauger · <i>Aspiratore</i> .....	48
Kämme und Bürstenreiniger <i>Detergente per pettini e spazzole</i> .....	49

## 02 Färbemittel Articoli per la tintura 50

Färberei-Zubehör · <i>Accessori colore</i> .....	51
Dochtstreifen · <i>Fogli termici per mèches</i> .....	53
Zeitschaltuhr · <i>Timer</i> .....	54
Wagen · <i>Bilance</i> .....	55
Färbeschüssel · <i>Vaschette tintura</i> .....	56
Kleine Färbepinsel · <i>Panello per tintura</i> .....	60
Nackenschutz und Schutz für Waschbecken <i>Lavatesta e protettori per lavatesta</i> .....	65
Misch und Messbecher · <i>Shaker e misurini</i> .....	66
Aluminiumfolie · <i>Foglio di alluminio</i> .....	68
Schutzbeutel · <i>Protettori</i> .....	70
Handschuhe · <i>Guanti</i> .....	71
Gummi Nackenumhang · <i>Coprispalle</i> .....	74
Einweg Umhänge · <i>Mantelline monouso</i> .....	75
Delantales · <i>Grembiuli</i> .....	88
Kinder-Umhänge · <i>Mantelline bambino</i> .....	90
Umkleideraum LACLA · <i>Abbigliamento LACLA</i> .....	92

## 03 Haarkosmetik Cosmetici per capelli 106

Bright Colour Farbstoffe · <i>Tinta per capelli BRIGHT.COLOUR</i> .....	107
Oxidierende OXY BRIGHT · <i>OXY BRIGHT ossidante</i> .....	114
Haarfärbemittel · <i>Tinta per capelli</i> .....	116
Bleichpulver · <i>Decolorante</i> .....	118
Behandlung IONI-K · <i>Trattamento ONI-K</i> .....	120
Shampoo, Haar-Kur · <i>Shampoo, Maschera capillare</i> .....	123
Veredelungsprodukte, Haarfasern <i>Prodotti di finitura, Fibre capillari</i> .....	129

## 04 Spangen und klammern Clip e fermagli 138

Steckklammern · <i>Mollette</i> .....	139
Haarklammer und Haarnadeln · <i>Forcine e mollette</i> .....	143
Haarklammern · <i>Pinzette</i> .....	150
Metall Haarpangen · <i>Fermagli in metallo</i> .....	156
Haargummis · <i>Elastici</i> .....	159
Turban · <i>Turbanti</i> .....	163
Haarnadeln mit Perlen · <i>Fermagli con perle</i> .....	164

## 05 Papier Carta 166

Handtücher und Schutz <i>Tovaglioli e protettori</i> .....	167
Dauerwellen Papier · <i>Carta permanente</i> .....	168
Kreppansatzpapier für den Hals · <i>Carta da collo</i> .....	169

## 06 Ausbildung Formazione 170

Schaufensterpuppen-Kopf, NATURHAAR · <i>Teste studio, capelli naturali</i> .....	171
Schaufensterpuppenköpfe SYNTHETISCHES <i>Teste studio, capelli sintetici</i> .....	176
BERGMANN-Trainingköpfe <i>Teste studio bergmann</i> .....	177
Halterungen · <i>Supporti</i> .....	179

## 07 Möbel Complementi d'arredo 180

Theken und Spiegel · <i>Banconi e specchi</i> .....	181
Friseurstühle für Kinder · <i>Poltrone da parrucchiere per bambini</i> .....	183
Hocker · <i>Sgabelli</i> .....	185
Friseurstühle · <i>Poltrone</i> .....	187
Kopfwaschanlage · <i>Poltrona lavatesta</i> .....	188
Friseurstuhl <i>Poltrona da parrucchiere</i> .....	194
Tragbare Kopfwaschanlagen · <i>Lavatesta portatile</i> .....	200
Arbeitswagen · <i>Carrelli</i> .....	201
Verschiedenes · <i>Vari</i> .....	205

## 08 Kämme und bürsten Pettini e spazzole 206

Kreppbürste · <i>Spazzola per cotonare</i> .....	207
Bürste · <i>Spazzole</i> .....	208
Rundholzbürste .....	209
<i>Spazzole circolare</i> .....	
Bürste mit Balg und Holzgriff .....	213
<i>Spazzole pneumatiche con manico in legno</i> .....	
Bürste mit Balg und Kunststoffgriff .....	217
<i>Spazzole pneumatiche, districanti</i> .....	
Bürste mit Balg und Kunststoffgriff .....	218
<i>Spazzole pneumatiche con manico in plastica</i> .....	
Bürste mit Balg und Gummigriff .....	224
<i>Spazzole pneumatiche con manico in gomma</i> .....	
Entwirrende Bürste · <i>Spazzole districante</i> .....	227
Aussteller Entwirrende · <i>Espositore Spazzole</i> .....	228
Farbige Skelettbürsten · <i>Spazzole scheletro colorata</i> .....	232
Flache Bürsten zum Entwirren · <i>Spazzole piatte per districare</i> .....	237
Baby-Bürsten · <i>Spazzole baby</i> .....	238
Wärmebürste .....	240
<i>Spazzola termica</i> .....	
Professionelle Kämme · <i>Pettini professionali</i> .....	246
Kämme aus carbon · <i>Pettini in CARBONIO</i> .....	258
Set Kämme Eurostil · <i>Eurostil set pettini</i> .....	261
Professionelle PEGASUS-Kämme · <i>Pettini professionali PEGASUS</i> .....	263
Professionelle Pollié-Kämme · <i>Pettini professionali</i> .....	264
Professionelle MATADOR-Kämme · <i>MATADOR Pettini professionali</i> .....	266
Silkomb Profi-Kämme · <i>Pettini professionali Silkomb</i> .....	269
Farbige Kämme · <i>Pettini colorati</i> .....	270
Dose mit farbigen Kämmen · <i>Pettini colorati</i> .....	274
Kämme Holzfarbe · <i>Pettini color legno</i> .....	279
Fingerkamm · <i>Pettine districante</i> .....	281
Muschel/Acetat-Kamm · <i>Pettine tartaruga/acetato</i> .....	283
Produktlinie aus recyceltem material <i>Linea di prodotti in materiale riciclato</i> .....	286

**09****Lockenwickler, duttkissen  
und kopfbedeckungen  
Bigodini, cuffie e retine****288**

Dauerwellenwickler aus Holz · <i>Bigodini in legno</i> .....	289
Dauerwellenwickler aus Plastik · <i>Bigodini di plastica</i> .....	291
Schaumlockenwickler · <i>Bigodini flessibili</i> .....	293
Lockenwickler · <i>bigodini</i> .....	294
Haarnete · <i>Retine</i> .....	302
Duttkissen · <i>Ciambelle acconciatura</i> .....	311

**11****Klebe-extensions undhaarteile  
Extension adesive e retine****336**

Haarteil · <i>Extension</i> .....	337
Ringe · <i>Anelli</i> .....	338
Extensions mit Clip · <i>Extension con clip</i> .....	339
Vercchiedenes · <i>Varis</i> .....	340

**10****Rasiermesser und haarschnei-  
descheren · Rasoi e forbici****315**

Verzierte Profi-Scheren .....	317
<i>Forbici professionali</i>	
Scheren · <i>Forbici</i> .....	324
Schere für Linkshänder · <i>Forbici speciali per MANCINI</i> .....	
Professionelle Scheren · <i>Forbici professionali</i> .....	325
Schere special academy kunststoffgriff · <i>Forbici speciali studenti</i> .....	327
Professioneller Scherenkoffer · <i>Astucci per forbici professionali</i> ...	329
Haarschneidmesser und Rasierklingen .....	330
<i>Rasoi</i>	331

**12****Verschiedenes  
Vari****342**

Watte · <i>Cotone</i> .....	343
Koffer · <i>Valigie</i> .....	344
Friseurtasche · <i>Porta utensili</i> .....	352
Facepro · <i>Facepro</i> .....	354
Verschiedenes · <i>Vari</i> .....	355
Halter für Perücken · <i>Porta parrucca</i> .....	356
Sprühflasche · <i>Spruzzatori</i> .....	357
Handtücher · <i>Asciugamani</i> .....	359
Hygiene-Artikel · <i>Articoli per l'igiene</i> .....	360

Die in diesem Katalog aufgeführten Preise sind empfohlene Preise, Steuern nicht inbegriffen.  
Die Preise gelten bis auf Tippfehler.  
Industrias Oriol 1942, S.L. behält sich das Recht vor, Änderungen ohne vorherige Ankündigung  
vorzunehmen.

*I prezzi indicati in questo catalogo sono prezzi consigliati, tasse escluse.  
I prezzi saranno validi salvo errori tipografici.  
Industrias Oriol 1942, S.L. si riserva il diritto di apportare modifiche senza preavviso.*



01

# Elektrogeräte

ARTICOLI  
ELETTRICI

*Föhne, Glätteisen, Lockenstab,  
Thermische Aktivatoren, Trockenhaube...*

*Asciugacapelli, piastre, ferri arricciacapelli,  
caschi e lampade a termostimolazione,  
caschi asciugacapelli...*



**Trockner CALIMA**  
**Asciugacapelli CALIMA**



NEW

REF. 07171/50

NEW

REF. 07171/70



18,6 cm



18,6 cm

- » Leistung: 2300 W
- » Professioneller AC Wechselstrommotor
- » Gewicht: 530 g
- » Luftdurchsatz 98 m<sup>3</sup>/h
- » 2 Geschwindigkeiten, 3 Temperaturen
- » Kaltluftstufe
- » 2 verstellbare Luftdüsen 62 und 70 mm
- » Abnehmbarer Filter aus Edelstahl
- » Kabel mit Ring zum Aufhängen
- » Niedriger Schallpegel: 80 dB
- » Spannung 220-240V~
- » Frequenz: 50/60 Hz
- » Super kompakt
- » Ion, Keramisch und Turmalin
- » Diffusorkompatibel: 04346/50

- » Potenza: 2300w
- » Motore AC professionale.
- » Peso: 530 gr.
- » Portata d'aria: 98 m<sup>3</sup>/h
- » 2 velocità, 3 temperature
- » Pulsante aria fredda.
- » 2 bocchette regolabili da 62 e 70 mm
- » Filtro estraibile in acciaio inossidabile
- » Cavo flessibile con anello per
- » Silenzioso: 80 Db
- » Voltaggio 220-240V~
- » Frequenza: 50/60 Hz
- » Super compatto
- » Ionico, Ceramica e Turmalina
- » Compatibile diffusore: 04346/50

## Trockner FURIOUS COMPACT PLUS

### Asciugacapelli FURIOUS COMPACT PLUS



Die Eurostil-Modelle Furious und Furious Plus stammen aus unserem Sortiment mit 2200W – Sie sind ideal für alle Profis, die einen vielseitigen und anspruchsvollen Haartrockner suchen.

*Gli asciugacapelli Eurostil Furious e Furious Plus sono una gamma di asciugacapelli da 2200 W ideali per qualsiasi professionista alla ricerca di un asciugacapelli versatile che soddisfi le aspettative più esigenti.*

- » Kompakter AC-Motor mit langer Lebensdauer
- » Gewicht: 494 gr
- » Luftdurchsatz: 84 m<sup>3</sup>/Stunde
- » 2 Geschwindigkeiten, 3 Temperaturen
- » Kaltluft-Knopf
- » 2 Düsen
- » Herausnehmbarer Filter
- » Sicherheitsthermostat
- » Kabel mit Ring zum Aufhängen
- » Spannung 220-240V~
- » Frequenz: 50/60 Hz
- » Lila Zierleiste
- » Kompatibel mit Diffusoren: 04346/50 - 01147

- » Potenza: 2200W.
- » Motore compatto di lunga durata AC
- » Peso: 494 gr.
- » Portata d'aria: 84 m<sup>3</sup>/ora
- » 2 velocità, 3 temperature
- » Pulsante aria fredda
- » 2 bocchette
- » Filtro rimovibile
- » Termostato di sicurezza
- » Cavo flessibile
- » Voltaggio 220-240V~
- » Frequenza: 50/60 Hz
- » Finitura viola
- » Compatibile con diffusori: 04346/50 - 01147



REF. 06474



## FURIOUS-Trockner Asciugacapelli FURIOUS

1  
u.m.vta12  
box

REF. 04922



- » Leistung: 2200W
- » Kompakter AC-Motor mit langer Lebensdauer
- » Gewicht: 590 gr
- » Luftdurchsatz: 74 m<sup>3</sup>/Stunde
- » 2 Geschwindigkeiten, 3 Temperaturen
- » Kaltluft-Knopf
- » 2 Düsen: 1 breit, 1 schmal
- » Herausnehmbarer Filter
- » Sicherheitsthermostat
- » Kabel mit Ring zum Aufhängen
- » Spannung 220-240V~
- » Frequenz: 50 Hz
- » Silberne Zierleiste
- » Kompatibel mit Diffusoren: 04346/50 - 01147

- » Potenza: 2200W.
- » Motore compatto di lunga durata AC
- » Peso: 590 gr.
- » Portata d'aria: 74 m<sup>3</sup>/ora
- » 2 velocità, 3 temperature
- » Pulsante aria fredda
- » 2 bocchette: 1 largo, 1 stretto
- » Filtro rimovibile
- » Termostato di sicurezza
- » Cavo flessibile
- » Voltaggio 220-240V~
- » Frequenza: 50 Hz
- » Finitura argento
- » Compatibile con diffusori: 04346/50 - 01147



22,6 cm



## Trockner Eurostil ZONDA

### Asciugacapelli Eurostil ZONDA



Die Haartrockner EUROSTIL sind mit der dreifachen TECHNOLOGIE (Ionen, Keramik und Turmalin) ausgestattet. Sie sind ein unverzichtbares Werkzeug für Fachleute. Sie spenden Feuchtigkeit, Geschmeidigkeit und Glanz, sie trocknen schneller, haben eine antibakterielle Wirkung und beschützen die Haarwurzeln. Sie begünstigen, jede Art von Frisur, ob glatt, wellig oder voluminös, zu gestalten.

*I nuovi asciugacapelli Eurostil dotati di TRIPLA TECNOLOGIA (ionica, ceramica e tormalina) sono uno strumento essenziale per i professionisti. Forniscono idratazione, morbidezza e lucentezza, asciugano più velocemente, hanno un effetto battericida e riducono l'invecchiamento della fibra capillare. Permettono di creare qualsiasi tipo di acconciatura: liscia, ondulata, voluminosa, ecc.*

REF. 04993/53

REF. 04993/70



23,6 cm



23,6 cm

- » Leistung: 2400W
- » Kompakter AC-Motor mit langer Lebensdauer
- » Gewicht: 590 gr
- » Luftdurchsatz: 97 m<sup>3</sup>/Stunde
- » 2 Geschwindigkeiten, 3 Temperaturen
- » Fester Kaltluft-Knopf
- » 2 einstellbare Düsen von 62 mm und 70 mm
- » Herausnehmbarer Filter
- » Sicherheitsthermostat
- » Flexibles Kabel 3m mit Ring zum Aufhängen
- » Niedriger Geräuschpegel
- » Spannung 220-240V~
- » Frequenz: 50/60 Hz
- » Filter aus rostfreiem Stahl
- » Ion-, Keramik und Turmalin
- » Kompatibel mit Diffusoren: 04346/50 - 01147 - 03036/50

- » Potenza: 2400W.
- » Motore compatto di lunga durata AC
- » Peso: 590 gr.
- » Portata d'aria: 97 m<sup>3</sup>/ora
- » 2 velocità, 3 temperature
- » Pulsante aria fredda fisso
- » 2 bocchette regolabili da 62mm e 70mm
- » Filtro rimovibile
- » Termostato di sicurezza
- » Cavo flessibile 3m
- » Silenzioso
- » Voltaggio 220-240V~
- » Frequenza: 50/60 Hz
- » Filtro in acciaio inossidabile
- » Ionico, Ceramica e Tormalina
- » Compatibile con diffusori: 04346/50 - 01147 - 03036/50

## WIND-Trockner Asciugacapelli WIND



Die mit TRIPLE TECHNOLOGY (ionisch, keramisch und Turmalin) ausgestatteten Windtrockner von Eurostil sind unverzichtbare Werkzeuge für Fachleute. Sie spenden Feuchtigkeit, Weichheit und Glanz, trocknen schneller, haben eine bakterizide Wirkung und reduzieren die Alterung der Haarfasern. Sie ermöglichen es, jede Art von Frisur zu kreieren: glatt, wellig, voluminös usw.

*I nuovi asciugacapelli Wind di Eurostil dotati di TRIPLA TECNOLOGIA (ionica, ceramica e tormalina) sono uno strumento essenziale per i professionisti. Forniscono idratazione, morbidezza e lucentezza, asciugano più velocemente, hanno un effetto battericida e riducono l'invecchiamento della fibra capillare. Permettono di creare qualsiasi tipo di acconciatura: liscia, ondulata, voluminosa, ecc.*



- » Leistung: 2300W
- » Kompakter AC-Motor mit langer Lebensdauer
- » Gewicht: 530 gr
- » Luftdurchsatz: 88 m<sup>3</sup>/Stunde
- » 2 Geschwindigkeiten, 3 Temperaturen
- » Kaltluft-Knopf
- » 2 einstellbare Düsen von 62 mm und 70 mm
- » Herausnehmbarer Filter
- » Sicherheitsthermostat
- » Flexibles Kabel 3m mit Ring zum Aufhängen
- » Niedriger Geräuschpegel
- » Spannung 220-240V~
- » Frequenz: 50/60 Hz
- » Mit Temperaturanzeigeleuchte
- » Filter aus rostfreiem Stahl
- » Kompatibel mit Diffusoren: 04346/50 - 01147 - 03036/50

- » Potenza: 2300W.
- » Motore compatto di lunga durata AC
- » Peso: 530 gr.
- » Portata d'aria: 88 m<sup>3</sup>/ora
- » 2 velocità, 3 temperature
- » Pulsante aria fredda
- » 2 bocchette regolabili da 62mm e 70mm
- » Filtro rimovibile
- » Termostato di sicurezza
- » Cavo flessibile 3m
- » Filtro in acciaio inossidabile
- » Silenzioso
- » Voltaggio 220-240V~
- » Frequenza: 50/60 Hz
- » Con spia della temperatura
- » Compatibile con diffusori: 04346/50 - 01147 - 03036/50



## KOMPAKTER PROFESSIONAL trockner Asciugacapelli COMPACT PROFESSIONAL



Der Profi-Trockner Compact hat ein attraktives, ergonomisches und leichtes Design. Erhältlich in schwarz, weiß und weiß mit farbigen Gummi. Leistungsstarker Motor mit Ionengenerator. Enthält zwei Düsen unterschiedlicher Größe.

*L'asciugacapelli professionale Compact ha un design accattivante, ergonomico e leggero. Disponibile in nero, bianco e bianco con guarnizioni colorate. Motore potente con generatore di ioni. Include due bocchette di dimensioni diverse.*

NEW



REF. 04202

21,5 cm

- » Leistung: 2000W
- » Kompakter AC-Motor mit langer Lebensdauer
- » Gewicht: 580 gr
- » Luftdurchsatz: 90 m3/Stunde
- » 2 Geschwindigkeiten, 3 Temperaturen
- » Kaltluft-Knopf
- » 2 einstellbare Düsen von 62 mm und 70 mm
- » Herausnehmbarer Filter
- » Sicherheitsthermostat
- » Flexibles Kabel 3m mit Ring zum Aufhängen
- » Niedriger Geräuschpegel
- » Spannung 220-240V~
- » Frequenz: 50/60 Hz
- » Ergonomische Gestaltung
- » Robustes und leichtes Polyamid-Gehäuse
- » Anti-Rutsch-Gummibesatz
- » Ionengenerator-Motor
- » Kompatibel mit Diffusoren: 04346/50 - 01147 - 03036/50

- » Potenza: 2000W.
- » Motore compatto di lunga durata AC
- » Peso: 580 gr.
- » Portata d'aria: 90 m3/ora
- » 2 velocità, 3 temperature
- » Pulsante aria fredda
- » 2 bocchette regolabili da 62mm e 70mm
- » Filtro rimovibile
- » Termostato di sicurezza
- » Cavo flessibile 3m
- » Silenzioso
- » Voltaggio 220-240V~
- » Frequenza: 50/60 Hz
- » Design ergonomico
- » Corpo in poliammide robusto e leggero
- » Rivestimento in gomma antiscivolo
- » Motore generatore di ioni
- » Compatibile con diffusori: 04346/50 - 01147 - 03036/50



REF. 04202/58/99

## KOMPAKTER EXTRA-LICHT-Trockner Asciugacapelli COMPACT EXTRA LIGHT



Der Profi-Trockner Compact hat ein attraktives, ergonomisches und leichtes Design. Erhältlich in schwarz, weiß und weiß mit farbigen Gummi. Leistungsstarker Motor mit Ionengenerator. Enthält zwei Düsen unterschiedlicher Größe.

L'asciugacapelli professionale Compact ha un design accattivante, ergonomico e leggero. Disponibile in nero, bianco e bianco con guarnizioni colorate. Motore potente con generatore di ioni. Include due bocchette di dimensioni diverse.



REF. 04203

21,5 cm



REF. 04203/58

21,5 cm



- » Leistung: 1800W
- » Gleichstrommotor
- » Gewicht: 430 gr
- » Luftdurchsatz: 76 m<sup>3</sup>/Stunde
- » 2 Geschwindigkeiten, 3 Temperaturen
- » Kaltluft-Knopf
- » 2 einstellbare Düsen von 62 mm und 70 mm
- » Herausnehmbarer Filter
- » Sicherheitsthermostat
- » Flexibles Kabel 3m mit Ring zum Aufhängen
- » Sehr niedriger Geräuschpegel
- » Spannung 220-240V~
- » Frequenz: 50/60 Hz.
- » Kompakt und LEICHTER
- » Anti-Rutsch-Gummibesatz
- » Mit Ionengenerator
- » Kompatibel mit Diffusoren: 04346/50 - 01147 - 03036/50

- » Potenza: 1800W.
- » Motore DC
- » Peso: 430 gr.
- » Portata d'aria: 76 m<sup>3</sup>/ora
- » 2 velocità, 3 temperature
- » Pulsante aria fredda
- » 2 bocchette regolabili da 62mm e 70mm
- » Filtro rimovibile
- » Termostato di sicurezza
- » Cavo flessibile 3m
- » Impatto acustico molto basso
- » Voltaggio 220-240V~
- » Frequenza: 50/60 Hz
- » Compatto e PIÙ LEGGERO
- » Rivestimento in gomma antiscivolo
- » Motore potente con generatore di ioni.
- » Compatibile con diffusori: 04346/50 - 01147 - 03036/50



REF. 04203/58/99



## Trockner NEO 3800 Asciugacapelli NEO 3800

**NEO3800**  
PROFESSIONAL



REF. 03323

- » Leistung: 2000W
- » Kompakter AC-Motor mit langer Lebensdauer
- » Gewicht: 590 gr
- » Luftdurchsatz: 84 m3/Stunde
- » 2 Geschwindigkeiten, 3 Temperaturen
- » Kaltluft-Knopf
- » 2 einstellbare Düsen 63 mm und 72 mm
- » Herausnehmbarer Filter
- » Sicherheitsthermostat
- » Flexibles Kabel 3m mit Ring zum Aufhängen
- » Spannung 220-240V~
- » Frequenz: 50/60 Hz
- » Thermischer Schutz
- » Kompatibel mit Diffusoren: 04346/50 - 01147 - 03036/50

- » Potenza: 2000W.
- » Motore compatto di lunga durata AC
- » Peso: 590 gr
- » Portata d'aria: 84 m3/ora
- » 2 velocità, 3 temperature
- » Pulsante aria fredda
- » 2 bocchette regolabili da 63 mm e 72mm
- » Filtro rimovibile
- » Termostato di sicurezza
- » Cavo flessibile 3m
- » Voltaggio 220-240V~
- » Frequenza: 50/60 Hz
- » Protezione termica
- » Compatibile con diffusori: 04346/50 - 01147 - 03036/50



## Trockner NEO 3830 Asciugacapelli NEO 3830

**ionic NEO 3830**  
PROFESSIONAL



REF. 03904

- » Leistung: 2000W
- » Kompakter AC-Motor mit langer Lebensdauer
- » Gewicht: 590 gr
- » Luftdurchsatz: 82 m3/Stunde
- » 2 Geschwindigkeiten, 3 Temperaturen
- » Kaltluft-Knopf
- » 2 einstellbare Düsen 62 mm und 70 mm
- » Herausnehmbarer Filter
- » Sicherheitsthermostat
- » Flexibles Kabel 3m mit Ring zum Aufhängen
- » Spannung 220-240V~
- » Frequenz: 50/60 Hz
- » Mit Turmalin und ionischen
- » Thermischer Schutz
- » Kompatibel mit Diffusoren: 04346/50 - 01147 - 03036/50

- » Potenza: 2000W.
- » Motore compatto di lunga durata AC
- » Peso: 590 gr.
- » Portata d'aria: 82 m3/ora
- » 2 velocità, 3 temperature
- » Pulsante aria fredda
- » 2 bocchette regolabili da 62mm e 70mm
- » Filtro rimovibile
- » Termostato di sicurezza
- » Cavo flessibile 3m
- » Voltaggio 220-240V~
- » Frequenza: 50/60 Hz
- » Con tormalina e ionico
- » Protezione termica
- » Compatibile con diffusori: 04346/50 - 01147 - 03036/50

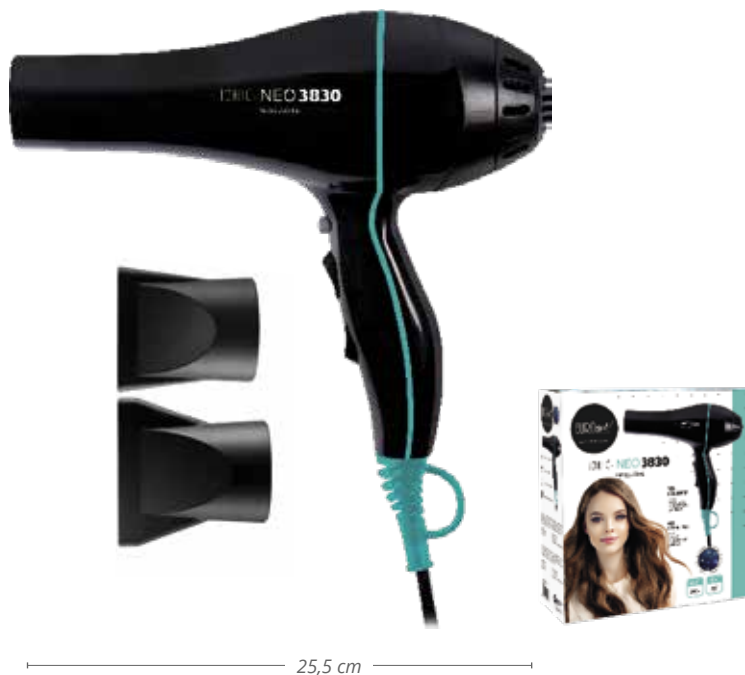

### Trockner NEO 3820 Asciugacapelli NEO 3820

ionic NEO 3820  
PROFESSIONAL



REF. 03905

- » Leistung: 2000W
- » Kompakter AC-Motor mit langer Lebensdauer
- » Gewicht: 585 gr
- » Luftdurchsatz: 79 m3/Stunde
- » 2 Geschwindigkeiten, 3 Temperaturen
- » Kaltluft-Knopf
- » 2 Düsen: 1 breit, 1 schmal
- » Herausnehmbarer Filter
- » Sicherheitsthermostat
- » Flexibles Kabel 3m mit Ring zum Aufhängen
- » Spannung 220-240V~
- » Frequenz: 50/60 Hz
- » Turmalin und Ionengenerator
- » 1 Diffusor

- » Potenza: 2000W.
- » Motore compatto di lunga durata AC
- » Peso: 585 gr.
- » Portata d'aria: 79 m3/ora
- » 2 velocità, 3 temperature
- » Pulsante aria fredda
- » 2 bocchette: 1 largo, 1 stretto
- » Filtro rimovibile
- » Termostato di sicurezza
- » Cavo flessibile 3m
- » Voltaggio 220-240V~
- » Frequenza: 50/60 Hz
- » Con tormalina e ionico
- » 1 diffusore



### Trockner NEO 3840 Asciugacapelli NEO 3840

ionic NEO 3840  
PROFESSIONAL



REF. 04363

- » Leistung: 2200W
- » Kompakter AC-Motor mit langer Lebensdauer
- » Gewicht: 590 gr
- » Luftdurchsatz: 83 m3/Stunde
- » 2 Geschwindigkeiten, 3 Temperaturen
- » Kaltluft-Knopf
- » 2 einstellbare Düsen: 1 breit, 1 schmal
- » Herausnehmbarer Filter
- » Sicherheitsthermostat
- » Flexibles Kabel 3m mit Ring zum Aufhängen
- » Spannung 220-240V~
- » Frequenz: 50/60 Hz
- » Ergonomische Gestaltung
- » Robustes und leichtes Polyamid-Gehäuse
- » Turmalin und Ionengenerator
- » Kompatibel mit Diffusoren: 04346/50 - 01147 - 03036/50

- » Potenza: 2200W.
- » Motore compatto di lunga durata AC
- » Peso: 590 gr.
- » Portata d'aria: 83 m3/ora
- » 2 velocità, 3 temperature
- » Pulsante aria fredda
- » 2 bocchette regolabili: 1 largo, 1 stretto
- » Filtro rimovibile
- » Termostato di sicurezza
- » Cavo flessibile 3m
- » Voltaggio 220-240V~
- » Frequenza: 50/60 Hz
- » Design ergonomico
- » Corpo in poliammide robusto e leggero
- » Con tormalina e ionico
- » Compatibile con diffusori: 04346/50 - 01147 - 03036/50



## TRAMUNTANA-Trockner Asciugacapelli TRAMUNTANA



Der Tramuntana-Trockner hat ein attraktives, ergonomisches und leichtes Design. Erhältlich in Schwarz und 4 sehr trendigen und angenehmen Farben. Enthält zwei Düsen unterschiedlicher Größe und einen Diffusor für lockiges Haar.

L'asciugacapelli Tramuntana ha un design accattivante, ergonomico e leggero. Disponibile in nero e 4 colori molto moderni. Include due bocchette di dimensioni diverse e un diffusore per capelli ricci.



REF. 04264/50

18,2 cm



### INCLUS · INCLUDE



REF. 04264/62



REF. 04264/64



REF. 04264/68



REF. 04264/75

- » Leistung: 2000W
- » Kompakter AC-Motor mit langer Lebensdauer
- » Gewicht: 500 gr
- » Luftdurchsatz: 70 m3/Stunde
- » 2 Geschwindigkeiten, 3 Temperaturen
- » Kaltluft-Knopf
- » 2 Düsen: 1 breit, 1 schmal
- » Herausnehmbarer Filter
- » Sicherheitsthermostat
- » Kabel 3m mit Ring zum Aufhängen
- » Spannung 220-240V~
- » Frequenz: 50/60 Hz
- » Schalter seitlich
- » 1 Diffusor
- » Diffusorkompatibel: 04346/50

- » Potenza: 2000W.
- » Motore compatto di lunga durata AC
- » Peso: 500 gr.
- » Portata d'aria: 70 m3/ora
- » 2 velocità, 3 temperature
- » Pulsante aria fredda
- » 2 bocchette: 1 largo, 1 stretto
- » Filtro rimovibile
- » Termostato di sicurezza
- » Cavo flessibile 3m
- » Voltaggio 220-240V~
- » Frequenza: 50/60 Hz
- » Pulsanti laterali
- » Compatibile diffusore: 04346/50
- » 1 diffusore
- » Compatibile diffusore: 04346/50

## Haartrockner MEDITERRÁNEO

### Asciugacapelli MEDITERRANEO

MEDITERRÁNEO



Der Mediterranean Dryer hat ein attraktives, ergonomisches und leichtes Design. Erhältlich in Schwarz und 4 sehr trendigen und angenehmen Farben. Enthält zwei Düsen unterschiedlicher Größe und einen Diffusor für lockiges Haar.

*L'asciugacapelli Mediterraneo ha un design accattivante, ergonomico e leggero. Disponibile in nero e 4 colori molto moderni. Include due bocchette di dimensioni diverse e un diffusore per capelli ricci.*



REF. 04263/50

#### EINSCHLIESSLICH · INCLUDE



18,2 cm



REF. 04263/62



REF. 04263/64



REF. 04263/68



REF. 04263/75

- » Leistung: 2000W
- » Kompakter AC-Motor mit langer Lebensdauer
- » Gewicht: 500 gr
- » Luftdurchsatz: 70 m3/Stunde
- » 2 Geschwindigkeiten, 3 Temperaturen
- » Kaltluft-Knopf
- » 2 Düsen: 1 breit, 1 schmal
- » Herausnehmbare Filter
- » Sicherheitsthermostat
- » Kabel mit Ring zum Aufhängen
- » Spannung 220-240V~
- » Frequenz: 50/60 Hz
- » 1 diffusor

- » Potenza: 2000W.
- » Motore compatto di lunga durata AC
- » Peso: 500 gr.
- » Portata d'aria: 70 m3/ora
- » 2 velocità, 3 temperature
- » Pulsante aria fredda
- » 2 bocchette: 1 largo, 1 stretto
- » Filtro rimovibile
- » Termostato di sicurezza
- » Cavo flessibile
- » Voltaggio 220-240V~
- » Frequenza: 50/60 Hz
- » 1 diffusore

## Trockner IL FUTURO Asciugatrice IL FUTURO

1 u.m.vta  
12 box

- » Leistung: 2150W
  - » Kompakter AC-Motor mit langer Lebensdauer
  - » Gewicht: 595 gr
  - » Luftdurchsatz: 70 m3/Stunde
  - » 2 Geschwindigkeiten, 3 Temperaturen
  - » Kaltluft-Knopf
  - » 2 Düsen
  - » Herausnehmbarer Filter
  - » Sicherheitsthermostat
  - » Kabel 3m mit Ring zum Aufhängen
  - » Spannung 220-240V~
  - » Frequenz: 50/60 Hz
  - » Neues System zur Emission negativer Ionen zur Beseitigung statischer Elektrizität aus dem Haar
  - » Traditioneller und seitlicher Griff
  - » Faltbar
  - » Mit Ionen
  - » Kompatibel mit Diffusoren: 04346/50 - 01147
- » Potenza: 2150W.
  - » Motore compatto di lunga durata AC
  - » Peso: 595 gr.
  - » Portata d'aria: 70 m3/ora
  - » 2 velocità, 3 temperature
  - » Pulsante aria fredda
  - » 2 bocchette
  - » Filtro rimovibile
  - » Termostato di sicurezza
  - » Cavo flessibile 3m
  - » Voltaggio 220-240V~
  - » Frequenza: 50/60 Hz
  - » Nuovo sistema di emissione di ioni negativi per eliminare l'elasticità statica del capello
  - » Impugnatura tradizionale e laterale
  - » Pieghevole
  - » Ionico
  - » Compatibile con diffusori: 04346/50 - 01147



REF.03051

FALTBA / PIEGHEVOLE



22 cm

## Trockner TURBO STRATOS 3800 ETI Asciugacapelli TURBO STRATOS 3800 ETI



1 u.m.vta  
12 box

- » Leistung: 2400W
  - » Kompakter AC-Motor mit langer Lebensdauer
  - » Gewicht: 590 gr
  - » Luftdurchsatz: 99 m3/Stunde
  - » 2 Geschwindigkeiten, 3 Temperaturen
  - » Kaltluft-Knopf
  - » 2 Düsen: 1 breit, 1 schmal
  - » Herausnehmbarer Filter
  - » Sicherheitsthermostat
  - » Kabel mit Ring zum Aufhängen
  - » Schallpegel: 69 dB
  - » Spannung 220-240V~
  - » Frequenz: 50/60 Hz
  - » Kompatibel mit Diffusoren: 04346/50 - 01147 - 03036/50
- » Potenza: 2400W.
  - » Motore compatto di lunga durata AC
  - » Peso: 590 gr.
  - » Portata d'aria: 99 m3/ora
  - » 2 velocità, 3 temperature
  - » Pulsante aria fredda
  - » 2 bocchette: 1 largo, 1 stretto
  - » Filtro rimovibile
  - » Termostato di sicurezza
  - » Cavo flessibile
  - » Impatto sonoro: 69 dB
  - » Voltaggio 220-240V~
  - » Frequenza: 50/60 Hz
  - » Compatibile con diffusori: 04346/50 - 01147 - 03036/50



REF.02931

24 cm

## NANO STRATOS 3700 ETI-Trockner Asciugacapelli NANO STRATOS 3700 ETI



1 u.m.vta  
12 box

- » Leistung: 2200W
  - » Professioneller AC-Motor mit langer Lebensdauer
  - » Gewicht: 575 gr
  - » Luftdurchsatz: 100 m3/Stunde
  - » 2 Geschwindigkeiten, 3 Temperaturen
  - » Kaltluft-Knopf
  - » 2 Düsen
  - » Herausnehmbarer Filter
  - » Sicherheitsthermostat
  - » Kabel mit Ring zum Aufhängen
  - » Schallpegel: niedrig
  - » Spannung 220-240V~
  - » Frequenz: 50/60 Hz
  - » Ausgezeichnete Technologie
  - » Kompatibel mit Diffusoren: 04346/50 - 01147 - 03036/50
- » Potenza: 2200W.
  - » Motore professionale di lunga durata AC
  - » Peso: 575 gr.
  - » Portata d'aria: 100 m3/ora
  - » 2 velocità, 3 temperature
  - » Pulsante aria fredda
  - » 2 bocchette
  - » Filtro rimovibile
  - » Termostato di sicurezza
  - » Cavo flessibile
  - » Voltaggio 220-240V~
  - » Impatto sonoro: basso
  - » Frequenza: 50/60 Hz
  - » Tecnologia avanzata
  - » Compatibile con diffusori: 04346/50 - 01147 - 03036/50



REF. 03003/50

19,8 cm

### Halter für Trockner Porta asciugacapelli



REF.04431

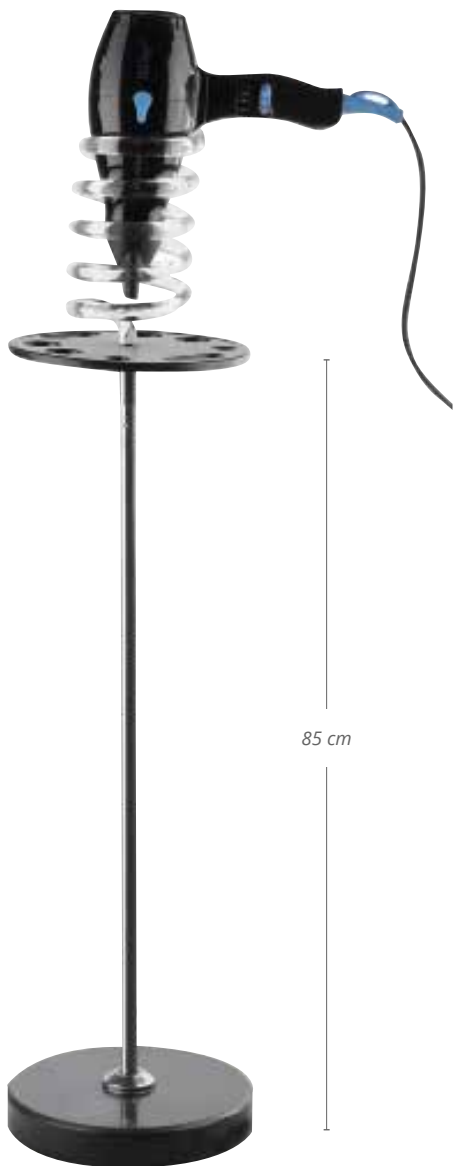

Ständer-Trocknerhalter aus Metall, geeignet für Trockner mit großer Düse. Leicht zu handhaben und zu bewegen, komfortabel für seine Stabilität. Elegantes und modernes Design.

Porta asciugacapelli con piedistallo in metallo, adatto per asciugacapelli con bocchette grandi. Facile da maneggiare e spostare, comodo per la sua stabilità. Design elegante e moderno.

### Metall-wandhalter Porta-asciugacapelli da parete in metallo



REF.07275

- » Material: aluminium
- » Mit gummeinfassung

- » Materiale: alluminio
- » Con finitura in gomma



### Verstellbarer Halter für Trockner Porta asciugacapelli adattabile



REF. 00672



- » Metall
- » Metallo



REF. 02830



## Universeller Diffusor

### Diffusore universale



Diffusor schwarz  
Diffusore nero



REF. 01147

Diffusor farbig  
Diffusore colori misti



REF. 01147/99



Diffusor schwarz  
Diffusore nero



REF. 03036/50

Diffusor farbig  
Diffusore colori misti



REF. 03036/99

### Faltbare SILICONE-Diffusoren

#### Diffusori pieghevoli in SILICONE

1  
u.m.vta

8  
box

- » Verteilt die Wärme gleichmäßig
- » Spezielles Design, leicht, faltbar und platzsparend
- » Universell, passt auf die meisten Trockner
- » Ref. 04346: Max. Höhe 12,9 cm min. 6,8 cm
- » Ref. 04346: Ø 6,3 cm - Ø 13,9 cm

- » Distribuisce il calore in modo uniforme
- » Design speciale, leggero, pieghevole e non occupa spazio
- » Universale, si adatta alla maggior parte degli asciugacapelli
- » Rif. 04346 Altezza massima 12,9 cm min. 6,8 cm
- » Rif. 04346 Ø 6,3 cm - Ø 13,9 cm



REF. 04346/62



REF. 04346/68



REF. 04346/64



REF. 04346/50



### Schaum-Diffusor

#### Diffusore in spugna

1  
u.m.vta

12  
box

Ideal, um die Dochtwirkungsarbeit zu wärmen,  
Färbung, Dauerwellen und Haarbehandlungen

*Ideale per fornire calore a meches, mettere colore,  
permanenti e trattamenti per capelli*



REF. 02371



### Schwarzer Aktivator

#### Attivatore nero

- » Leistung: 900W
- » Thermostimulator der neuesten Generation
- » Kompakt, braucht wenig Platz
- » Es wirkt mittels Wärme, so dass die Farbe in kurzer Zeit eindringt
- » Mit Zeitschaltuhr, elektronische Regelung der Energieabstrahlung
- » 5 einzelne Schalter zum Einschalten jeder der Lampen
- » Widerstandstyp: Infrarot
- » Maximale Temperatur 40°C
- » Frequenz: 50 Hz
- » Spannung 220-240V~

- » Potenza: 900W.
- » Stimolatore di calore di ultima generazione
- » Compatto, occupa poco spazio
- » Agisce per mezzo del calore in modo che il colore penetri velocemente
- » Con timer, regolatore elettronico della radiazione di energia
- » 5 singoli interruttori per accendere ciascuna delle lampade
- » Tipo di resistenza: infrarossi
- » Temperatura massima 40°C
- » Frequenza: 50 Hz
- » Voltaggio 220-240V~



Standfuß  
Con piedistallo

REF.03007

Wandhalter  
Supporto a parete

REF.03008

### Weißer Aktivator

#### Attivatore bianco

- » Leistung: 1400W
- » Kompakter Thermostimulator der neuesten Generation
- » Es hat Belüftung
- » Mit Zeitschaltuhr, elektronischer Energiestrahlungsregler
- » Digitale Anzeige
- » Spannung: 220-240V~
- » Material: Nylon
- » Art der Resistenz: Infrarot
- » 3 Geschwindigkeiten

- » Potenza: 1400W.
- » Stimolatore di calore di ultima generazione compatto
- » Con ventilazione
- » Con timer, regolatore elettronico della radiazione di energia
- » Display digitale
- » Tensione: 220-240V~
- » Materiale: nylon
- » Tipo di resistenza: infrarossi
- » 3 velocità



Standfuß  
Con piedistallo

REF.04273

Wandhalter  
Supporto a parete

REF.04274

### Elektronischer fernbetätigungsschalter schwarz

#### Termostimolatore elettronico nero

Kompakter Thermostimulator für Friseure, mit einem innovativen Design, das den höchsten Komfort für den Kunden bietet.

NEW

Eigenschaften:

- » Timer
- » Elektronischer Regler für die Energieabstrahlung
- » 5 einzelne Schalter zum Ein- und Ausschalten jeder kreisförmigen Lampe

Termostimolatore per parrucchieri compatto e dal design innovativo che offre il massimo confort per la cliente.

Caratteristiche:

- » Temporizzatore
- » Regolazione elettronica dell'irradiazione di energia
- » 5 interruttori singoli per l'accensione e spegnimento di ogni lampada circolar



Mit fuss  
Con base da terra

REF.07433

Mit wandhalterung  
Supporto a parete

REF.07434

## Trockenhaube atomic turbo mit fuss

### Casco ASCIUGACAPELLI ATOMIC turbo con base da terra



Professionelle Haartrockenhaube, mit Timer, Thermostat, Temperatur-Kontrollleuchte und Geschwindigkeitsregler.

- » Retro-futuristisches Design mit integrierter Blende
- » Höhere Leistung- 1400W ULTRA POWER
- » Glocke mit Luftstromausrichtung

#### Konfigurationen:

- » Automatisch / 1 Geschwindigkeit
- » 4 Geschwindigkeiten TURBO

Casco asciugacapelli professionale con temporizzatore, termostato, spia di controllo della temperatura e selettore di velocità.

- » Design retro-futuristico con visiera integrata
- » Potenza maggiorata - 1400W ULTRA POWER
- » Campana con direzionamento del flusso d'aria

#### Configurazioni:

- » Automatico/1 velocità
- » 4 velocità TURBO



NEW

Standfuß  
Con piedistallo

REF.07436



## Turbo-Hauben-Trockner GONG

### Casco asciugacapelli Turbo GONG



- » Frequenz: 50 Hz
- » Leistung 1400W
- » TURBO-Geschwindigkeiten mit Zeitschaltuhr, Regelthermostat und Kontrollleuchte. Motor mit 4 Geschwindigkeiten ab 600 U/min
- » Geschwindigkeit 1: Leistung für freies und netzfreies Kämmen und Trocknen
- » Geschwindigkeit 2: Leistung für normales Kämmen und Trocknen
- » Geschwindigkeit 3: schnelle Trocknung
- » Geschwindigkeit 4: ultraschnelle Trocknung dank des hohen und gleichmäßigen Luftstroms

- » Frequenza: 50 Hz
- » Potenza 1400W.
- » Velocità TURBO con timer, termostato di regolazione e spia di controllo. Motore a 4 velocità da 600 giri al minuto
- » Velocità 1: servizi professionali di acconciatura e asciugatura libera senza retina
- » Velocità 2: servizi professionali di acconciatura e asciugatura normale
- » Velocità 3: asciugatura rapida
- » Velocità 4: asciugatura ultrarapida grazie all'elevata uniformità del portata d'aria



1 Geschwindigkeit  
1 velocità

1 Geschwindigkeit  
1 velocità

REF. 03005/50

REF. 03005/58

- » Modernes und ergonomisches design.
- » "Monofork"-system, das probleme beim brechen des scharnieres vermeidet
- » Trockner. Sehr schnelles trocknen durch den großen luftstrom verteilt
- » Gleichmässig
- » Einlassmessdurchmesser 28 cm
- » Inner max measure diameter 39 cm

- » Design moderno ed ergonomico.
- » Sistema "monoforzo" che previene problemi di rottura della cerniera anteriore
- » Essiccatore. Asciugatura molto veloce per il grande portata d'aria distribuita
- » Uniformemente
- » Diametro misurato aspirazione 28 cm
- » Misura massima interna diametro 39 cm

**Haubentrockner GONG**  
**Casco asciugacapelli GONG**

- » Leistung 1400W
- » 1 Geschwindigkeit
- » Modernes und ergonomisches Design
- » Sehr schneller Trockner aufgrund des gleichmäßig verteilten hohen Luftstroms
- » Höhe 210 cm für die Wandmontage des Arms

- » Potenza 1400W.
- » 1 velocità
- » Design moderno ed ergonomico
- » Asciugacapelli molto veloce grazie al grande portata d'aria distribuito in modo uniforme
- » Altezza di 210 cm per montare il braccio alla parete

 Wandhalter  
 Supporto a parete

**REF. 03006**
**REF. 03006/58**
**Haubentrockner HOT WIND automatisch**  
**Casco asciugacapelli HOT WIND automatico**

- » Leistung: 1000W
- » Spannung: 220-240V~
- » Frequenz: 50/60Hz
- » 1 Geschwindigkeit
- » Motor mit 1300 U/min
- » Werkstoff: Stahl
- » Haubenmaterial: ABS

- » Potenza: 1000W
- » Voltaggio: 220-240V~
- » Frequenza: 50/60Hz
- » 1 velocità
- » Motore da 1300 rpm
- » Materiale: acciaio
- » Materiale del casco: ABS

 Standfuß  
 Con piedistallo

**REF. 04272/50**
**Ceriotti-Dampfhaube mit Standfuß**  
**Vaporizzatore Ceriotti con piedistallo**

 Pink  
 Fucsia

 Silber  
 Argento

- » Leistung: 1000W
- » Haube mit verstellbarem Visier Nylon, Polycarbonat und Stahl
- » Ohne OZONE

- » Potenza: 1000W.
- » Campana con visiera regolabile in nylon, policarbonato e acciaio
- » Senza OZON

**REF.04275/68**
**REF.04275/54**

**Ceriotti-Dampfhaube GEYSER OZONO mit Standfuß**  
**Vaporizzatore Ceriotti GEYSER OZONO con piedistallo**

Professioneller Zerstäuber für Schönheits- und Heilbehandlungen. Erzeugt Dampf, Geyser begünstigt die Absorption der Haarpflegeprodukte durch die Kopfhaut und reduziert die Zeit der Exposition erheblich. Die Ozonlampe erzeugt (bei den angepassten Modellen) einen sterilisierenden Effekt, der dabei helfen kann, die Gesundheit des Haar und der Haut zu verbessern.

Vaporizzatore professionale per trattamenti estetico curativi. Generando vapore, Geyser aiuta la penetrazione dei prodotti tricologici nelle cuticole riducendo drasticamente i tempi di posa. La lampada ad ozono (nei modelli predisposti) produce un effetto sterilizzante che può aiutare a migliorare la salute del capello e della cute.

- » Timer
- » Elektronischer Regler für Temperatur und Dampfmenge
- » Betriebsanzeige
- » Kondensat-Behälter
- » Ozonlampe

- » Temporizzatore
- » Regolatore elettronico della temperatura e della quantità di vapore
- » Spia di funzionamento
- » Serbatoio condensa
- » Lampada ad ozono

**NEW**
**REF.07435**

**Haubentrockner ORLA**  
**Casco asciugacapelli ORLA**

- » Leistung: 1175W
- » Spannung: 220-240V~
- » Frequenz: 50/60Hz
- » 5 Geschwindigkeiten
- » Zeituhr maximal 60 Minuten
- » Temperatur maximal 70°C
- » Das Gerät verfügt über eine Sicherheitsvorrichtung, die im Falle einer Fehlfunktion automatisch aktiviert wird

- » Potenza: 1175W.
- » Voltaggio: 220-240V~
- » Frequenza: 50/60Hz
- » 5 velocità
- » Timer 60 minuti massimo
- » Temperatura massima 70°C
- » L'apparecchio dispone di un dispositivo di sicurezza che si attiva automaticamente in caso di malfunzionamento del dispositivo

Wandhalter  
Supporto a parete

REF.03314

Innendurchmesser  
Misura interna

33 cm

Standfuß  
Con piedistallo

REF.03313

Öffnung  
Dimensione  
massima di entrata**Eurostil-Dampfhaube**  
**Vaporizzatore Eurostil**

- » Leistung: 400W
- » Vorwärmesystem
- » Einschaltanzeige-LED
- » LED-Licht und Ton, die Wassermangel im Verdampfer anzeigen
- » Ozon-Generator
- » Zeitschaltuhr
- » Innenbehälter für Wasserkondensation (Dampferzeugung)
- » mit Entlastungsventil und System zur Rückführung
- » NUR destilliertes Wasser kann verwendet werden

- » Potenza: 400W.
- » Sistema di preriscaldamento
- » Spia LED di alimentazione
- » Spia LED luminosa e acustica per indicare la mancanza d'acqua nel vaporizzatore
- » Generatore di ozono
- » Timer
- » Serbatoio interno per condensazione acqua (produzione vapore)
- » Con valvola di sfogo e sistema per eventuale ritorno
- » È possibile utilizzare SOLO acqua distillata

Standfuß  
Con piedistallo

REF.03315

Wandhalter  
Supporto a parete

REF.03316

**Valera Haubentrockner**  
**Casco asciugacapelli Valera**



- » Leistung: 600W
- » 3m langes Kabel
- » Komfortabler und ergonomischer Haubentrockner
- » 2 Geschwindigkeiten und 3 Temperaturen
- » Kaltluft-Schalter
- » Ultraleicht, leise und weicher Oberfläche
- » Praktische Reisetasche inklusive
- » Ionen-Generator
- » Frequenz: 50/60 Hz

- » Potenza: 600W.
- » Cavo di 3m di lunghezza
- » Casco asciugacapelli comodo ed ergonomico
- » 2 velocità e 3 temperature
- » Pulsante aria fredda
- » Ultraleggero, silenzioso e morbido al tatto
- » Pratica borsa da viaggio inclusa
- » Generatore di ioni
- » Frequenz: 50/60 Hz

Haubentrockner mit Ionisator VALERA mod. Ionic Confort

Casco asciugacapelli con ionizzatore VALERA mod. Ionic Confort



REF. 04615

**Heizwickler**  
**Rulli caldi**

**REMINGTON** 



- » Leistung: 300W
- » 20 rollen, die in weichem velvet abgedeckt und mit wachs gefüllt sind eine weiche folie und anhaltende wärme
- » Ionen für erschrockenes haar
- » 3 grössen: 4 kleine (20 mm), 10 mittel (23 mm) und 6 grosse de 27 mm)
- » Power indicator pilot
- » Anzeigelicht, das die farbe ändert, wenn die rollen bereit sind verwenden rollen mit kalten enden für ein einfaches styling
- » 20 farbige gabeln und klemmklammer nach rollentyp

- » Potenza: 300W.
- » 20 rulli rivestiti in morbido velluto e riempiti di cera per ottenere un morbido scivolo e calore che dura
- » Ioni per capelli spaventati
- » 3 misure: 4 small (20 mm), 10 medium (23 mm) e 6 grandi (27 millimetri)
- » Pilota indicatore di potenza
- » Indicatore luminoso che cambia colore quando i rulli sono pronti uso rulli a freddo per un facile stile
- » 20 forche colorate e clip di fissaggio a seconda del tipo di rullo

REF. 06241



## EASY-Platten Piastra EASY



Keramikplatten mit Turmalin, die das Haar pflegen und ihm Glanz und Geschmeidigkeit verleihen. Seine ionische Ladung verhindert, dass das Haar elektrisiert und kraus wird, und mit der Nano-Silber-Technologie werden Bakterien eliminiert. Automatische Abschaltautomatik: Das Gerät schaltet sich automatisch ab, wenn ca. 60 Minuten nicht benutzt wird.

*Piastra in ceramica con tormalina che si prendono cura dei capelli donando lucentezza e morbidezza. La carica ionica impedisce ai capelli di diventare elettrici e crespi e la tecnologia Nano Silver elimina i batteri. Funzione autospegnimento automatico: l'apparecchio si spegne automaticamente se non viene utilizzato dopo circa 60 minuti.*

- » Temperatur zwischen 130°C - 230°C
- » Leistung: 44W
- » Sicherheitsthermostat
- » Kabellänge: 2,7 m Kabel mit 360°-Drehung

- » Temperatura tra 130°C - 230°C
- » Potenza: 44W.
- » Termostato di sicurezza
- » Misura del cavo: 2,7 m con rotazione di 360°



REF. 06332/68

REF. 06332/70

## INFRAROT Glätteisen Keramik und Turmalin Piastra a INFRAROSSI con ceramica e tormalina



Keramikplatten mit Turmalin, die das Haar pflegen und ihm Glanz und Geschmeidigkeit verleihen. Seine ionische Ladung verhindert, dass das Haar elektrisiert und kraus wird, und mit der Nano-Silber-Technologie werden Bakterien eliminiert. Automatische Abschaltautomatik: Das Gerät schaltet sich automatisch ab, wenn ca. 60 Minuten nicht benutzt wird. Infrarotlicht, das das Haar entgiftet und desinfiziert und gleichzeitig die harte Wärmeübertragung der Platten reduziert. Seine Haupteigenschaften sind die Verbesserung der Durchblutung und die Stimulierung des Haarwuchses.

*Piastra in ceramica con tormalina che si prendono cura dei capelli donando lucentezza e morbidezza. La carica ionica impedisce ai capelli di diventare elettrici e crespi e la tecnologia Nano Silver elimina i batteri. Funzione autospegnimento automatico: l'apparecchio si spegne automaticamente se non viene utilizzato dopo circa 60 minuti. Luce infrarossa che disintossica e disinfetta i capelli e allo stesso tempo riduce l'aggressione del calore delle piastre. Le sue principali proprietà sono il miglioramento della circolazione e la stimolazione della crescita dei capelli.*

- » Temperatur zwischen: 130°C - 230°C
- » Leistung: 44W
- » Sicherheitsthermostat
- » Kabellänge: 2,7 m Kabel mit 360°-Drehung
- » Plattenheizung: 20 Sekunden
- » MCH-Widerstand
- » LCD-Display mit Temperaturanzeige
- » Interner Thermostat verhindert Überhitzung
- » „SOFT-TOUCH“ Griff
- » Keramik und Turmalin

- » Temperatura tra: 130°C - 230°C
- » Potenza: 44W.
- » Termostato di sicurezza
- » Misura del cavo: Cavo da 2,7 m con rotazione di 360°
- » Riscaldamento della piastra: 20 secondi
- » Resistenza MCH
- » Display LCD che indica la temperatura
- » Termostato interno che impedisce il surriscaldamento
- » Manico "SOFT-TOUCH"
- » Ceramica e tormalina



REF. 06331/68

## FRIZZE Profi-Glätteisen

### Piastra professionale FRIZZE



Turmalinplatten, die das Haar pflegen und ihm Glanz und Geschmeidigkeit verleihen. Seine ionische Ladung verhindert, dass das Haar elektrisiert und kraus wird, und mit der Nano-Silber-Technologie werden Bakterien eliminiert.

*Piastra con tormalina che si prendono cura dei capelli donando lucentezza e morbidezza. La carica ionica impedisce ai capelli di diventare elettrici e crespi e la tecnologia Nano Silver elimina i batteri.*



REF. 06163/68



- » Temperatur: zwischen 130°C und 230°C
- » Leistung: 65W
- » Sicherheitsthermostat
- » Kabellänge: 3 m Kabel mit 360°-Drehung
- » Spannung: 110 - 240 V~
- » Frequenz: 50/60 Hz
- » Automatische Abschaltung nach 60 Minuten
- » Widerstand: ultraschnelle Erwärmung mit PTC-Widerstand
- » Temperatureinstellung per Skala
- » Mikroprozessor-Steuerung
- » Soft touch Oberfläche
- » Temperatur-Leuchtanzeiger
- » Keramik und Turmalin
- » 3 austauschbare Platten
- » Für natürliches Haar
- » NICHT FÜR SYNTHETISCHES ODER NASSES HAAR VERWENDEN

- » Temperatura tra 130°C - 230°C
- » Potenza: 65W.
- » Termostato di sicurezza
- » Misura del cavo: Cavo da 3 m con rotazione di 360°
- » Voltaggio: 110 - 240 V~
- » Frequenza: 50/60 Hz
- » Spegnimento automatico dopo 60 minuti di inutilizzo
- » Resistenza: riscaldamento ultra rapido con resistenza PTC
- » Regolatore della temperatura a manopola
- » Controllo con microprocessore
- » Finitura soft touch
- » Spia della temperatura
- » Ceramica e tormalina
- » 3 piastre intercambiabili
- » Per capelli naturali
- » NON USARE SU CAPELLI SINTETICI O BAGNATI

**Professionelles Keramik- und Turmalin-Glätteisen****Piastra professionale con CERAMICA e TORMALINA**

Keramikplatten mit Turmalin, die das Haar pflegen und ihm Glanz und Geschmeidigkeit verleihen. Seine ionische Ladung verhindert, dass das Haar elektrisiert und kraus wird, und mit der Nano-Silber-Technologie werden Bakterien eliminiert.

*Piastra in ceramica con tormalina che si prendono cura dei capelli donando lucentezza e morbidezza. La carica ionica impedisce ai capelli di diventare elettrici e crespi e la tecnologia Nano Silver elimina i batteri.*



REF. 06173/50



REF. 06173/53



REF. 06173/70



- » Temperatur: zwischen 80°C und 230°C
- » Leistung: 43W
- » Interner Thermostat verhindert Überhitzung
- » Kabellänge: 3 m Kabel mit 360°-Drehung
- » Spannung: 110 - 240 V~
- » Frequenz: 50/60 Hz
- » LCD-Display zur Anzeige der Temperatur
- » Automatische Abschaltung nach 60 Minuten
- » Widerstand: Erwärmung der Platten in nur 20 Sekunden, mit MCH-Widerstand
- » Temperatureinstellung mit Hilfe von Tasten
- » Soft-Touch-Griff
- » Temperatur-Speicher
- » Für natürliches Haar
- » NICHT FÜR SYNTHETISCHES ODER NASSES HAAR VERWENDEN

- » Temperatura tra 80°C - 230°C
- » Potenza: 43W.
- » Termostato interno che impedisce il surriscaldamento
- » Misura del cavo: Cavo da 3 m con rotazione di 360°
- » Voltaggio: 110 - 240 V~
- » Frequenza: 50/60 Hz
- » Display LCD che indica la temperatura
- » Spegnimento automatico dopo 60 minuti di inutilizzo
- » Resistenza: riscaldamento della piastra in soli 20 secondi, con resistenza MCH
- » Regolatore della temperatura a pulsante
- » Manico "SOFT-TOUCH"
- » Memoria della temperatura
- » Per capelli naturali
- » NON USARE SU CAPELLI SINTETICI O BAGNATI



**Profi-Eisen TITANIUM**  
**Piastra professionale TITANIO**



Titanplatten, die das Haar pflegen und ihm Glanz und Geschmeidigkeit verleihen, und mit der Nano-Silber-Technologie, die Bakterien eliminiert.

*Piastrre in Titanio che si prendono cura dei capelli donando loro lucentezza e morbidezza e con tecnologia Nano Silver che elimina i batteri.*



REF. 06174/50

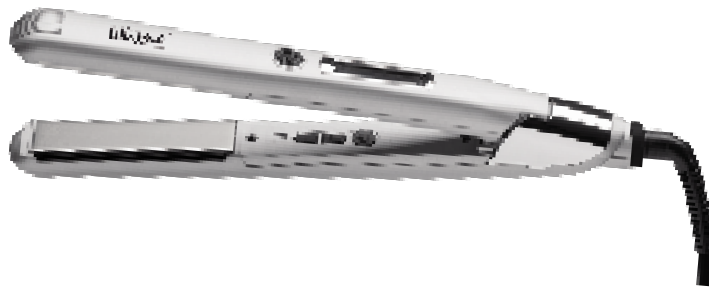

REF. 06174/54



REF. 06174/70



- » Temperatur: zwischen 80°C und 230°C
- » Leistung: 38W
- » Interner Thermostat verhindert Überhitzung
- » Kabellänge: 3 m Kabel mit 360°-Drehung
- » Spannung: 110 - 240 V~
- » Frequenz: 50/60 Hz
- » LCD-Display zur Anzeige der Temperatur
- » Automatische Abschaltung nach 60 Minuten
- » Widerstand: Erwärmung der Platten in nur 20 Sekunden, mit MCH-Widerstand
- » Temperatureinstellung mit Hilfe von Tasten
- » Soft-Touch-Griff
- » Temperatur-Speicher
- » Keramik und Turmalin
- » Für natürliches Haar
- » NICHT FÜR SYNTHETISCHES ODER NASSES HAAR VERWENDEN

- » Temperatura tra 80°C - 230°C
- » Potenza: 38W.
- » Termostato interno che impedisce il surriscaldamento
- » Misura del cavo: Cavo da 3 m con rotazione di 360°
- » Voltaggio: 110 - 240 V~
- » Frequenza: 50/60 Hz
- » Display LCD che indica la temperatura
- » Spegnimento automatico dopo 60 minuti di inutilizzo
- » Resistenza: riscaldamento della piastra in soli 20 secondi, con resistenza MCH
- » Regolatore della temperatura a pulsante
- » Manico "SOFT-TOUCH"
- » Memoria della temperatura
- » Ceramica e tormalina
- » Per capelli naturali
- » NON USARE SU CAPELLI SINTETICI O BAGNATI

**ADVANCE Profi-Eisen****Piastra professionale ADVANCE**

Keramikplatten, die das Haar pflegen und ihm Glanz und Geschmeidigkeit verleihen, sowie die Nano-Silber-Technologie, die Bakterien eliminiert.

*Piastra in ceramica che si prendono cura dei capelli donando loro lucentezza e morbidezza e con tecnologia Nano Silver che elimina i batteri.*



REF. 06139/50

REF. 06139/70

REF. 06139/71



- » Temperatur: zwischen 130°C und 230°C
- » Leistung: 50W
- » Interner Thermostat verhindert Überhitzung
- » Kabellänge: 2,7 m Kabel mit 360°-Drehung
- » Spannung: 110 - 240 V~
- » Frequenz: 50/60 Hz
- » LCD-Display zur Anzeige der Temperatur
- » Automatische Abschaltung nach 60 Minuten
- » Widerstand: Erwärmung der Platten in nur 20 Sekunden, mit MCH-Widerstand
- » Temperatureinstellung mit Hilfe von Tasten
- » Soft-Touch-Griff
- » Für natürliches Haar
- » NICHT FÜR SYNTHETISCHES ODER NASSES HAAR VERWENDEN

- » Temperatura tra 130°C - 230°C
- » Potenza: 50W.
- » Termostato interno che impedisce il surriscaldamento
- » Misura del cavo: Cavo da 2,7 m con rotazione di 360°
- » Voltaggio: 110 - 240 V~
- » Frequenza: 50/60 Hz
- » Display LCD che indica la temperatura
- » Spegnimento automatico dopo 60 minuti di inutilizzo
- » Resistenza: riscaldamento della piastra in soli 20 secondi, con resistenza MCH
- » Regolatore della temperatura a pulsante
- » Manico "SOFT-TOUCH"
- » Per capelli naturali
- » NON USARE SU CAPELLI SINTETICI O BAGNATI

## Professionelles IONIC-Eisen

### Piastra professionale IONIC



Keramikplatten, die das Haar pflegen und ihm Glanz und Geschmeidigkeit verleihen, sowie die Nano-Silber-Technologie, die Bakterien eliminiert.

*Piastrre in ceramica che si prendono cura dei capelli donando loro lucentezza e morbidezza e con tecnologia Nano Silver che elimina i batteri.*



REF. 06138/50

REF. 06138/59

REF. 06138/53



- » Temperatur: zwischen 130°C und 230°C
- » Leistung: 44W
- » Interner Thermostat verhindert Überhitzung
- » Kabellänge : 2,7 m Kabel mit 360°-Drehung
- » Spannung: 110 - 240 V~
- » Frequenz: 50/60 Hz
- » LED-Display zur Anzeige der Temperatur
- » Automatische Abschaltung nach 60 Minuten
- » Widerstand: Erwärmung der Platten in nur 20 Sekunden, mit MCH-Widerstand
- » Temperatureinstellung mit Hilfe von Tasten
- » Soft-Touch-Griff
- » Ionengenerator, der das Haar weich macht und befeuchtet und so die Trockenzeit verkürzt.
- » Plattenverriegelungssystem über Hebel
- » Keramik und Turmalin
- » Für natürliches Haar
- » NICHT FÜR SYNTHETISCHES ODER NASSES HAAR VERWENDEN

- » Temperatura tra 130°C - 230°C
- » Potenza: 44W.
- » Termostato interno che impedisce il surriscaldamento
- » Misura del cavo: Cavo da 2,7 m con rotazione di 360°
- » Voltaggio: 110 - 240 V~
- » Frequenza: 50/60 Hz
- » Display LCD che indica la temperatura
- » Spegnimento automatico dopo 60 minuti di inutilizzo
- » Resistenza: riscaldamento della piastra in soli 20 secondi, con resistenza MCH
- » Regolatore della temperatura a pulsante
- » Manico "SOFT-TOUCH"
- » Generatore di ioni, che ammorbidisce e idrata i capelli, riducendo i tempi di asciugatura.
- » Sistema di chiusura delle piastre tramite leva
- » Ceramica e tormalina
- » Per capelli naturali
- » NON USARE SU CAPELLI SINTETICI O BAGNATI

## PLATINIUM-Keramik-Glätteisen Piastra ceramica PLATINIUM

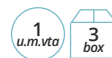

PLATINIUM-Platten mit kippbaren Keramik- und Turmalinplatten  
Piastra PLATINIUM con piastre basculanti in ceramica e tormalina

REF. 06145

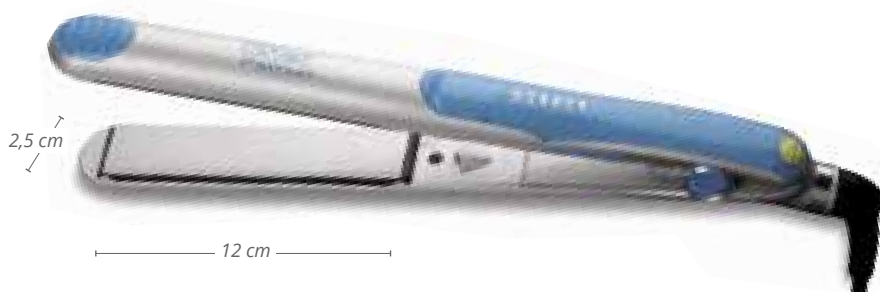

- » Temperatur: zwischen 150°C und 230°C
- » Leistung: 48W
- » Kabellänge: 2,7 m Kabel mit 360°-Drehung
- » Spannung: 220 - 240 V~
- » Frequenz: 50/60 Hz
- » Automatische Abschaltung nach 60 Minuten
- » Widerstand: Erwärmung der Platten in nur 20 Sekunden, mit MCH-Widerstand
- » Temperatureinstellung per Skala
- » Plattenverriegelungssystem über Hebel
- » Ionen-Generator
- » NICHT FÜR SYNTHETISCHES ODER NASSES HAAR VERWENDEN

- » Temperatura tra 150°C - 230°C
- » Potenza: 48W.
- » Misura del cavo: Cavo da 2,7 m con rotazione di 360°
- » Voltaggio: 220 - 240 V~
- » Frequenza: 50/60 Hz
- » Spegnimento automatico dopo 60 minuti di inutilizzo
- » Resistenza: riscaldamento della piastra in soli 20 secondi, con resistenza MCH
- » Regolatore della temperatura a manopola
- » Sistema di chiusura delle piastre tramite leva
- » Generatore di ioni
- » NON USARE SU CAPELLI SINTETICI O BAGNATI



**Mini-Keramik-Haarglätter Zange**  
**Mini piastra con placche in ceramica**

Keramikplatten mit Turmalin, die das Haar pflegen und ihm Glanz und Geschmeidigkeit verleihen  
Piastrre in ceramica con tormalina che si prendono cura dei capelli donando lucentezza e morbidezza

REF. 06568/50



- » Maximale Temperatur 200°C
- » Leistung: 22W
- » Sicherheitsthermostat
- » 2 m langes Gummikabel
- » Spannung: 100-240V~
- » Frequenz: 50/60 Hz
- » Aufheizen der Platten in nur 30 Sekunden, mit PTC-Widerstand
- » PTC-Widerstand verhindert Überhitzung
- » Geeignet für alle natürlichen Haartypen
- » NICHT FÜR SYNTHETISCHES ODER NASSES HAAR VERWENDEN

REF. 06568/68



- » Temperatura massima 200°C
- » Potenza: 22W
- » Termostato di sicurezza
- » Cavo in gomma lungo 2m
- » Voltaggio: 100-240V~
- » Frequenza: 50/60 Hz
- » Riscaldamento della piastra in soli 30 secondi, con resistenza PTC
- » Resistenza PTC che impedisce il surriscaldamento
- » Adatta a qualsiasi tipo di capello naturale
- » NON USARE SU CAPELLI SINTETICI O BAGNATI

REF. 06568/70

**Accessoires**  
**Accessori**

REF. 02991

- » Halter für Glätteisen schmal Typ (06139) Mit Saugnäpfen

- » Supporto per piastra stretta modello 02926
- » Con ventose



REF. 03076

- » Fingerschutz für hohe Temperaturen

- » Protezione per le dita alte temperature



REF. 03857

- » Handschuh 3-Finger-Hochtemperaturschutz

- » Guanto protettivo a 3 dita per alte temperature



**Glätteisenbürste**  
*Spazzola lisciante*

REF. 04583

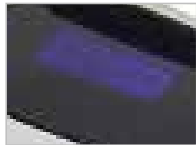

- » Temperatur zwischen: 80°C und 230°C
- » Leistung: 55W
- » Interner Thermostat verhindert Überhitzung Aufheizen in 60 Sekunden
- » 2,5 m langes, um 360° drehbares Kabel
- » Spannung 220-240V~
- » LCD-Bildschirm
- » Automatische Abschaltung in 60 Minuten, wenn nicht verwendet
- » Für natürliches Haar
- » NICHT FÜR SYNTHETISCHES ODER NASSES HAAR VERWENDEN

- » Temperatura tra: 80°C - 230°C
- » Potenza: 55W.
- » Termostato interno che impedisce il surriscaldamento.
- » Cavo giratorio 360°, 2,5 m di lunghezza
- » Voltaggio 220-240V~
- » Display LCD
- » Spegnimento automatico in 60 min. se non utilizzato
- » Per capelli naturali
- » NON USARE SU CAPELLI SINTETICI O BAGNATI



## Dampf-Glätteisenbürste

### Spazzola piastra a vapore



Neues Dampfglätteisen mit Eurostil-Bürste der letzten Generation und Ausführung. Es ermöglicht Ihnen, Ihr Haar zu glätten, ohne es zu beschädigen, da der Wasserdampf das Haar während des Glättens vor dem Austrocknen schützt. Ihr Haar erhält ein glattes, glänzendes und gesundes Aussehen und Finish. Professionelle Nutzung.

*Nuova piastra a vapore con spazzola Eurostil di ultima generazione e design. Ti permette di lisciare i capelli senza danneggiarli grazie al suo vapore acqueo che protegge i capelli dalla disidratazione durante la lisciatura. I capelli avranno un aspetto e una finitura liscia, lucente e sana. Uso professionale.*



REF. 04737/50

REF. 04737/58

REF. 04737/68

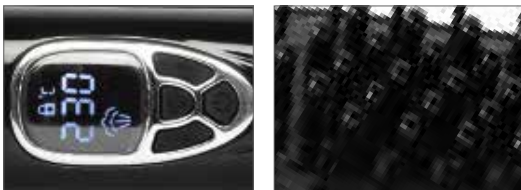

- » Temperatur: einstellbar zwischen 150°C und 230°C
- » Leistung: 75W
- » Interner Thermostat verhindert Überhitzung
- » Kabellänge: 2,5 m Kabel mit 360°-Drehung
- » Spannung 220-240V~
- » Frequenz: 50/60 Hz
- » LCD-Display mit Temperaturanzeige
- » Automatische Abschaltung nach 60 Minuten
- » Widerstand: Aufheizen in nur 90 Sekunden, mit PTC-Widerstand
- » Temperatureinstellung per Skala
- » Wasserdampf-Funktion
- » Geeignet für alle natürlichen Haartypen.
- » NICHT BEI KUNSTHAAR ANWENDEN



- » Temperatura: regolabile tra 150°C - 230°C
- » Potenza: 75W
- » Termostato interno che impedisce il surriscaldamento
- » Misura del cavo: Cavo da 2,5 m con rotazione di 360°
- » Voltaggio 220-240V~
- » Frequenza: 50/60 Hz
- » Display LCD che indica la temperatura
- » Spegnimento automatico dopo 60 minuti
- » Resistenza: riscaldamento della piastra in soli 90 secondi, con resistenza PTC
- » Regolatore della temperatura a manopola
- » Funzione vapore
- » Adatta a qualsiasi tipo di capello naturale
- » NON USARE SU CAPELLI SINTETICI

### Mit Zwei-Wege-Rotation Con rotazione bidirezionale



Leistung: 45W  
Potenza: 45W

REF. 04637

Ø 13-25



13 cm



Leistung: 70W  
Potenza: 70W

REF. 04639

Ø 32



13,5 cm

- » Temperatur einstellbar zwischen: 130°C und 220°C
- » Interner Thermostat verhindert Überhitzung
- » 360° drehbares Gummikabel und 2,5 m lang
- » LCD-Bildschirm
- » Automatische Sicherheitsabschaltfunktion
- » Rohrbeschichtung aus Keramik und Turmalin
- » Drehknöpfe der Pinzette (rechts oder links)
- » Perlweißer Griff
- » Geeignet für jedes natürliche Haar
- » NICHT FÜR SYNTHETISCHES ODER NASSES HAAR GEEIGNET

- » Temperatura: regolabile tra 100°C - 220°C
- » Termostato interno che impedisce il surriscaldamento
- » Cavo in gomma girevole a 360° e lungo 2,5 m
- » Display LCD
- » Funzione di spegnimento automatico di sicurezza
- » Rivestimento dei tubi in ceramica e tormalina
- » Pulsanti rotazione arricciatura a destra o a sinistra
- » Manico bianco perla
- » Adatta a qualsiasi tipo di capello naturale
- » NON ADATTO PER CAPELLI SINTETICI O BAGNATI





**Dreifach-Stab**  
Tripla barra

REF. 04594



Ø 22



- » Temperatur einstellbar zwischen 130°C und 220°C
- » Leistung 65W
- » Gummikabel drehbar um 360° und ist 2,5 m lang
- » Universelle Selbststeuerungs-Spannung 100-240V~
- » LCD-Bildschirm
- » Automatische Abschaltfunktion nach 60 Minuten ohne Aktivität
- » Keramik- und Turmalinbeschichtung der Röhren, die das Haar pflegen und ihm Glanz und Weichheit verleihen
- » Schnelles und sicheres Heizsystem
- » Soft-Touch-Griff
- » Für natürliches Haar
- » NICHT FÜR SYNTHETISCHES ODER NASSES HAAR GEEIGNET

- » Temperatura: regolabile tra 130°C - 220°C
- » Potenza 65W
- » minuti senza attività
- » Cavo in gomma girevole a 360° e lungo 2,5 m
- » Autocontrollo universale del voltaggio 100-240 V~
- » Display LCD
- » Spegnimento automatico dopo 60 minuti di inutilizzo
- » Rivestimento tubolare in ceramica e tormalina che si prende cura dei capelli donando lucentezza e morbidezza
- » Sistema di riscaldamento veloce e sicuro
- » Manico "SOFT-TOUCH"
- » Per capelli naturali
- » NON ADATTO PER CAPELLI SINTETICI O BAGNATI

**Konisch**  
ConicoØ 13-25  
REF. 04593Ø 19-32  
REF. 04598

- » Leistung: 65W
- » Temperatur einstellbar zwischen 130°C und 220°C
- » Gummikabel drehbar um 360° und ist 2,5 m lang
- » Universelle Spannungssteuerung 100-240V~
- » LCD-Bildschirm
- » Automatische Abschaltfunktion nach 60 Minuten ohne Aktivität
- » Keramik- und Turmalinbeschichtung der Röhren, die das Haar pflegen und ihm Glanz und Weichheit verleihen
- » Schnelles und sicheres Heizsystem
- » Soft-Touch-Griff
- » Für natürliches Haar
- » NICHT FÜR SYNTHETISCHES ODER NASSES HAAR GEEIGNET

- » Potenza: 65W
- » Temperatura: regolabile tra 130°C - 220°C
- » Cavo in gomma girevole a 360° e lungo 2,5 m
- » Autocontrollo universale del voltaggio 100-240 V~
- » Display LCD
- » Spegnimento automatico dopo 60 minuti di inutilizzo
- » Rivestimento tubolare in ceramica e tormalina che si prende cura dei capelli donando lucentezza e morbidezza
- » Sistema di riscaldamento veloce e sicuro
- » Manico "SOFT-TOUCH"
- » Per capelli naturali
- » NON ADATTO PER CAPELLI SINTETICI O BAGNATI



## Lockenstab mit Klemme Piastra per arricciacapelli

- » Temperatur einstellbar zwischen 185°C und 195°C
- » Leistung 25W
- » Gummikabel drehbar um 360° und ist 2,5 m lang
- » Spannung 230V~
- » Frequenz: 50 Hz
- » Mit Klemme

- » Temperatura: regolabile tra 185°C - 195°C
- » Potenza 25W.
- » Cavo in gomma girevole a 360° e lungo 2,5 m
- » Voltaggio 230V~
- » Frequenza: 50 Hz
- » Con pinza



REF. 01664



REF. 01981

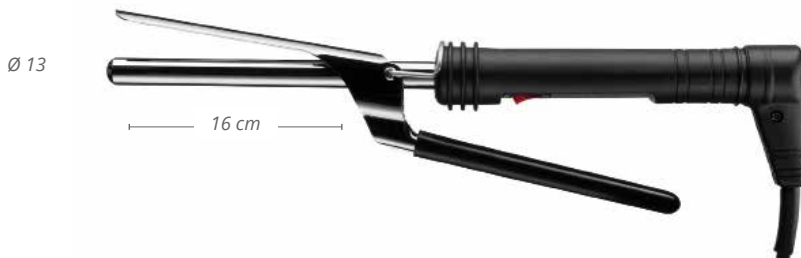

REF. 01665

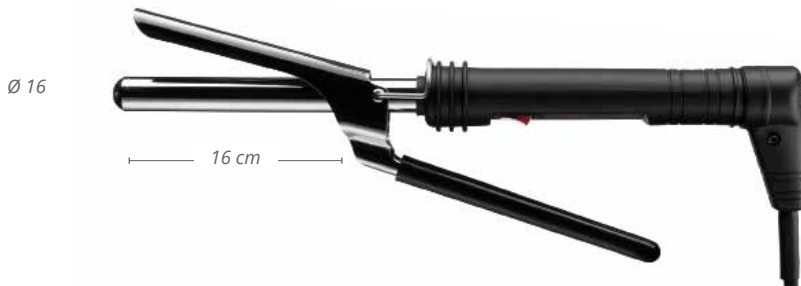

REF. 01666

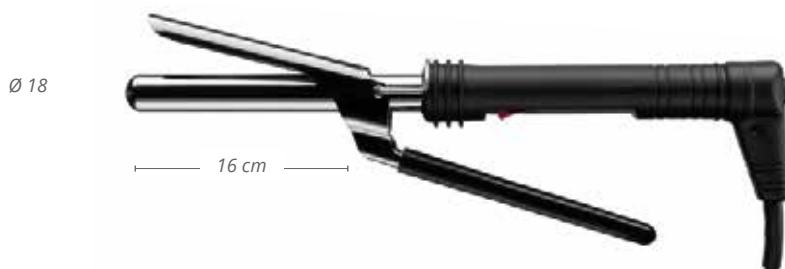

REF. 01667

**Lockenstab mit Klemme**  
**Piastra per arricciacapelli**

- » Temperatur einstellbar zwischen 185°C und 195°C
- » Leistung: 25W
- » Gummikabel drehbar um 360° und ist 2,5 m lang
- » Spannung 230V~
- » Frequenz: 50 Hz
- » Mit Klemme

- » Temperatura: regolabile tra 185°C - 195°C
- » Potenza: 25W
- » Cavo in gomma girevole a 360° e lungo 2,5 m
- » Voltaggio 230V~
- » Frequenza: 50 Hz
- » Con pinza

Ø 22



REF. 01982

Ø 25



REF. 01668

Ø 32



REF. 02797

**Unsere klassische Serie an Lockenstäben**  
**La nostra linea più classica di arricciacapelli**

## Turmalin-Keramik Lockenstab

### Arricciacapelli in ceramica e tormalina



- » Temperatur von 80°C bis 210°
- » Leistung: 65W
- » Thermostat zur Vermeidung von Überhitzung
- » 2,5 m langes 360°-Schwenkkabel
- » LCD-Bildschirm
- » Automatische Abschaltung nach 60 Minuten ohne Aktivität
- » Keramik- und Turmalinbeschichtung
- » Schnelles und sicheres Heizsystem
- » Hält die Temperatur konstant
- » Für natürliches Haar
- » Soft-Touch-Griff

- » Temperatura da 80°C a 210°
- » Potenza: 65W
- » Termostato per evitare il surriscaldamento
- » Cavo giratorio 360°, 2,5 m di lunghezza
- » Display LCD
- » spegnimento automatico dopo 60 minuti di inutilizzo
- » Rivestimento in ceramica e tormalina
- » Sistema di riscaldamento veloce e sicuro
- » Mantiene la temperatura costante
- » Per capelli naturali
- » Manico "SOFT-TOUCH"



REF. 04847

Ø 19



15,6 cm

REF. 04848

Ø 22



15,6 cm

REF. 04849

Ø 25



15,6 cm

REF. 04850

Ø 28



15,6 cm

REF. 04851

Ø 32



15,6 cm

REF. 04852

Ø 38



15,6 cm

**Zweifach Lockenstab**  
*Arricciacapelli a doppio tubo*1  
u.m.vta 12  
box

REF. 03413

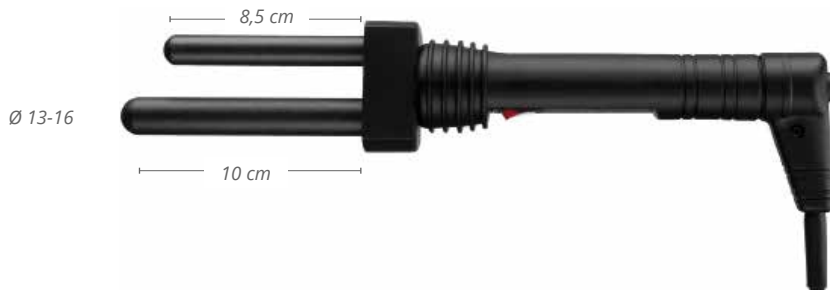

- » Temperatur von 185°C bis 195°C
- » Leistung: 25W
- » 2,5 m langes 360°-Schwenkkabel
- » Spannung 230-240V~
- » Frequenz: 50 Hz
- » Ideal, um wellige Locken zu erzeugen
- » Schnelles und sicheres Heizsystem
- » Hält die Temperatur konstant
- » Glattere, definiertere Locken

- » Temperatura da 185°C a 195°C
- » Potenza: 25W
- » Cavo giratorio 360°, 2,5 m di lunghezza
- » Voltaggio 230-240V~
- » Frequenza: 50 Hz
- » Ideale per fare onde finger waves
- » Sistema di riscaldamento veloce e sicuro
- » Mantiene la temperatura costante
- » Ricci con finitura più liscia e definita

**Konischer Lockenstab**  
*Arricciacapelli conico*1  
u.m.vta 1  
box

REF. 03414

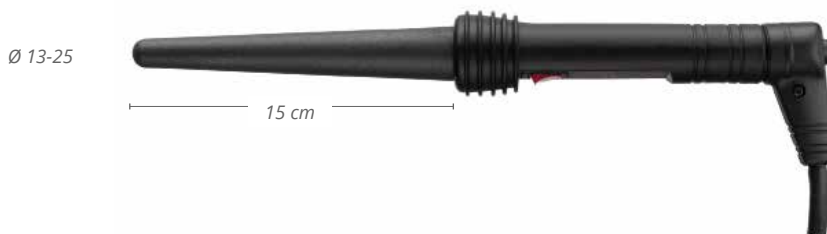

- » Temperatur von 185°C bis 195°C
- » Leistung: 25W
- » Aluminiumrohr mit Teflonbehandlung
- » Schnelles und sicheres Heizsystem
- » Hält die Temperatur konstant

- » Temperatura da 185°C a 195°C
- » Potenza: 25W
- » Tubo in alluminio con trattamento in Teflon
- » Sistema di riscaldamento veloce e sicuro
- » Mantiene la temperatura costante

**Elektrische Wärmebürste**  
*Spazzola elettrica termica*1  
u.m.vta 1  
box

REF. 01949



- » Temperatur von 185°C bis 195°C
- » Leistung: 25W
- » 2,5 m langes 360°-Schwenkkabel
- » Spannung 230V~
- » Frequenz: 50 Hz
- » Ideal für weiche Locken

- » Temperatura da 185°C a 195°C
- » Potenza: 25W
- » Cavo giratorio 360°, 2,5 m di lunghezza
- » Voltaggio 230V~
- » Frequenza: 50 Hz
- » Ideal para cachos macios

## Schweißzange für Extensions Saldatore per extension

Leistung: 21W  
Potenza: 21W



REF. 02557



Leistung: 26W  
Potenza: 26W



REF. 02558



## Nachfüllbarer Farbmischer Miscelatore colorante ricaricabile



REF. 04092



Ideal zum schnellen und automatischen Mischen von Farbstoffen  
*Ideale per miscelare i coloranti in modo rapido e automatico*



- » Leistung: 9W
- » Spannung: 100-240V~
- » Wiederaufladbarer Mischer (Gesamtladezeit 180 Minuten und funktioniert dann 80 Minuten)
- » Funktioniert im Leerlauf 100 Minuten
- » 4 Schalen mit 400 ml mit rutschfestem Gummi und 4 Haarfärbepinsel
- » Hält an, wenn Sie den Deckel öffnen
- » Zeitauswahl 45-60 und 75 s
- » Mit manueller Ein-/Ausschalttaste, die Funktion kann angehalten werden oder wird automatisch nach 3min gestoppt.
- » Die Mischgitter sind aus rostfreiem Stahl mit einer Kunststoffbeschichtung
- » Ersatz-Deckel Mischer RE04092/01
- » Ersatz-Mischgitter RE04092/02
- » Abmessungen 156 x 126 x 139 mm

- » Potenza: 9W
- » Voltaggio: 100-240V~
- » Miscelatore ricaricabile (carica totale 180 minuti e 80 min di funzionamento)
- » A vuoto funziona 100 minuti
- » 4 ciotole con gomma antiscivolo da 400 ml e 4 pennelli
- » Si ferma se il coperchio viene aperto
- » Selezione del tempo 45-60 e 75 s
- » Con il pulsante on/off manuale, se viene acceso funziona circa 3 minuti e si ferma se viene spento per qualsiasi motivo.
- » Le eliche sono in acciaio inossidabile rivestite in plastica
- » Ricambio coperchio miscelatore RE04092/01
- » Ricambio elica miscelatore RE04092/02
- » Dimensioni 156 x 126 x 139 mm



**UV-Sterilisator Eurostil-Kunststoff**  
**Sterilizzatore UV Eurostil in plastica**

REF. 06618

- » Leistung: 8W
- » Ultraviolett-Sterilisator für alle Arten von Werkzeugen sowohl für die Friseur- als auch für die Schönheitspflege

- » Potenza: 8W
- » Sterilizzatore ultravioletto per tutti i tipi di strumenti, sia per parrucchieri che per estetisti

**Ersatzteile · Ricambi**Ersatz-UV-Lampe  
Ricambio lampadina UV

REF. RE06618/01

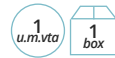
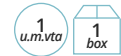
**Sterilisator Eurostil UV-Aluminium**  
**Sterilizzatore Eurostil UV in alluminio**

REF. 03317

- » Leistung: 8W
- » Geeignet für die Sterilisation von kleinen Utensilien aus Kunststoff oder Metall unter Verwendung einer keimtötenden UVC-Lampe
- » Nicht für andere, nicht angegebene Objekte verwenden
- » Die Glühbirne hält etwa 1300/1500 Stunden (= 1 Jahr Betriebsdauer)

- » Potenza: 8W
- » Indicato per la sterilizzazione di piccoli utensili in plastica o metallo mediante una lampadina UVC germicida.
- » Non utilizzare con altri oggetti non indicati.
- » La lampadina dura circa 1300/1500 ore (= 1 anno di funzionamento).

**Keimtötender Sterilisator gx4**  
**Sterilizzatore germicida gx4**

REF. 03009/59

- » Leistung: 15W
- » Temperatur von 20°C bis 200°C
- » Ultraflach. Hochwertiges keimtötendes Licht

- » Potenza: 15W.
- » Temperatura da 20°C a 200°C
- » Ultra piatto. Luce germicida di alta qualità

Ersatz-UV-Lampe  
Ricambio lampadina UV

REF. RE00891/01

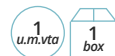

### Sanity Security Heissluft-Sterilisator

#### Sterilizzatore a calore secco Sanity Security

1  
u.m.vta

1  
box

REF. 03011

- » Temperatur von 20°C bis 200°C
- » Leistung 400W
- » Innenmaße: 25 cm x 14,5 cm x 7 cm

- » Temperatura da 20°C a 200°C
- » Potenza 400W.
- » Misure interne: 25 cm x 14,5 cm x 7 cm



### EUROSTIL-Quarz-Sterilisator

#### Sterilizzatore al quarzo EUROSTIL

1  
u.m.vta

6  
box

REF. 07013

- » Quarz
  - » Ideal für Metallutensilien wie Käämme, Scheren
  - » Inklusive Tasche mit Quarzperlen
- » Quarzo
  - » Ideale per utensili in metallo come pettini e forbici, etc.
  - » Include borsa con perle di quarzo



### Medisana Elektrischer Läusekamm

#### Pettine elettrico per pidocchi Medisana

1  
u.m.vta

4  
box

REF. 06584

- » Entfernt Läuse und Nissen bei einfachem Abbürsten.
- » Läuse werden durch elektrischen Strom bei Kontakt mit den Zinken des Kamms zerstört
- » Keine Nebenwirkungen, da keine Chemikalien benötigt werden
- » Batterien enthalten: 1 × 1,5v aa
- » Gewicht: 95 gr ca.

- » Elimina pidocchi e lendini con una semplice spazzolatura
- » I pidocchi vengono distrutti da una corrente elettrica a contatto con i denti del pettine
- » Nessun effetto collaterale perché non sono necessari prodotti chimici
- » Batterie incluse: 1 × 1,5v AA
- » Peso: 95 gr. aprox.





## Haarabsauger Aspiratore per capelli



Der Absauger HAIR VACUUM mit moderner Technologie erleichtert die Arbeit für den Fachmann. Er verfügt über zwei Arbeitseinstellungen:  
1) Handbetrieb: Für eine Absaugdauer von 5 sek. Bei Bedarf kann man es mit Knopfdruck mehrmals aktivieren.  
2) Autobetrieb: Mit Hilfe der leistungsfähigen Sensoren können die Resthaare dauernd abgesaugt werden, das erleichtert dem Fachmann die Arbeit. Das Gerät schaltet aus, wenn keine Reste mehr vorhanden sind.

*Aspiratore per capelli di ultima tecnologia. In modalità manuale, spazza i capelli verso la bocchetta di aspirazione alla base dell'apparecchio. Premere il pulsante di attivazione manuale e lasciare che HAIR VACUUM aspiri i capelli attraverso la bocchetta di aspirazione e li conservi nel deposito.*

*1. La modalità MANUALE durerà 5 secondi. A seconda della quantità di capelli, potrebbe essere necessario premere il pulsante di attivazione manuale più di una volta.*

*2. Quando la manopola di controllo viene ruotata sulla posizione AUTO, aspira i detriti attraverso la bocchetta di aspirazione alla base dell'apparecchio e i sensori rilevano i detriti e avviano automaticamente un ciclo di aspirazione che terminerà una volta che i sensori non rileveranno alcun capello.*



REF. 06612



- » Nennleistung: 1400 W
- » Modell: VA001A-BK
- » Nennspannung: 220-240V~
- » Frequenz: 50/60Hz
- » Größe: (Länge x Breite x Höhe): 33 cm Länge x 21 Breite x 56,4 cm Höhe
- » Nettogewicht: etwa 5,1Kg
- » Betriebsgeräusch: ≥83db 1,5m
- » Automatischer Arbeitsmodus: Einführung von Infrarotstrahlung
- » Sog (Zugfestigkeit): ≥2,8 Kg
- » Fassungsvermögen des Behälters: 2,7L MAX
- » Netzkabel Expositionsgröße: 2m

- » Potenza nominale: 1400 W.
- » Modello: VA001A-BK
- » Voltaggio nominale: 220-240V~
- » Frequenza: 50/60Hz
- » Dimensioni: (lunghezza x larghezza x altezza): 33 cm di lunghezza x 21 di larghezza x 56,4 cm di altezza
- » Peso netto: circa 5,1kg
- » Rumore di funzionamento: ≥83db 1,5 m
- » Modalità di lavoro automatica: introduzione di radiazione infrarossa
- » Aspirazione (forza di trazione): ≥2,8 Kg
- » Capacità del serbatoio dell'immondizia: 2,7 L MAX
- » Dimensioni del cavo di alimentazione: 2m

## Kämme und bürstenreiniger Pulitore per pettini e spazzole

1  
u.m.v.a.

6  
box



Auf Knopfdruck werden Ihre Bürsten in wenigen Sekunden gereinigt und bieten so einen besseren Service für Sie und Ihre Kunden.

*Semplicemente premendo un pulsante, le tue spazzole verranno pulite in pochi secondi, offrendo così un servizio migliore a te e ai tuoi clienti.*

- » Leistung: 120W
- » Spart Zeit bei der Reinigung von Bürsten und Kämmen
- » Unterscheiden Sie Ihr Unternehmen durch mehr Hygiene für den Kunden
- » Halten Sie die Bürsten nach jedem Gebrauch sauber
- » Hilft Ihnen, Ihre Arbeit besser zu erledigen

- » Potenza: 120W.
- » Risparmia tempo nella pulizia di spazzole e pettini
- » Distingue la tua attività offrendo maggiore igiene ai clienti
- » Tiene le spazzole pulite dopo ogni utilizzo
- » Aiuta ad eseguire meglio il lavoro

REF. 06954



02

# Färbemittel

ACCESSORI  
COLORE

*Schüsseln, Haarpinsel, Waagen, Schutzhüllen,  
Handschuhe, Aluminiumfolie, Friseurumhang...*

*Ciotole, spatole, bilance, mantelle,  
guanti, fogli di alluminio, protettori...*



## Zubehör Accessori

36  
u.m.vta

36  
box

REF. 00699



Neutralisierungsschwamm mit Halter  
*Spugna neutralizzante con sostegno*

36  
u.m.vta

36  
box

REF. 00971



Ersatzschwamm  
*Ricambio della spugna*

12  
u.m.vta

120  
box

REF. 03035



Färbelöffel 18 cm  
*Spatola applicatrice 18 cm*

## Spezialspatel für Strähnen und Balayage Spatole speciali per meches e balayage

Die Kellen sind ideal für Balayage und kalifornische Strähnen, da sie die Haarsträhnen beim Auftragen des Farbstoffs oder Bleichmittels unterstützen. Balayage ist eine französische Technik, die in den 90er Jahren in Mode kam und mit der man eine gleichmäßige Verteilung der Leichtigkeit im Haar erhält. Das Wort "Balayage" bedeutet "fegen", und gerade durch das Fegen der Farbe von den Wurzeln bis zu den Enden wird ein natürliches und leuchtendes Aussehen erreicht. Dies sind die klassischen kalifornischen Highlights sowohl für Blondinen als auch für Brünette.

*Le spatole sono ideali per lavori di balayage e per meches californiane, poiché forniscono supporto per sostenere le ciocche di capelli per applicare il colore o il decolorante. Il balayage è una tecnica francese diventata di moda negli anni '90, con la quale si ottiene una distribuzione uniforme della luminosità nei capelli. La parola "balayage" significa "spazzare" ed è proprio così, spazzando il colore dalle radici alle punte, che si ottiene un aspetto naturale e luminoso. Sono le classiche meches californiane, sia per capelli castani, che per capelli biondi.*

10  
u.m.vta

100  
box

REF. 01845



48  
u.m.vta

48  
box

REF. 00977



10  
u.m.vta

60  
box

REF. 02172



## Zubehör Accessori

Quetschschlüssel mit Band zum Umhängen  
*Spremitubetto con laccetto per appendere*



1 u.m.vta  
100 box

REF. 02537

ROLL-KA Kamm mit Produktapplikator  
*Pettine ROLL-KA con applicatore di prodotto*



1 u.m.vta  
6 box

REF. 02680

## Tuben Quetsche Spremitubo

Kleine Aluminium-  
Quetschpresse  
*Spremitubo acciaio*

1 u.m.vta  
12 box

REF. 01959

Kunststoff-Tuben  
Quetscher  
*Spremitubo in plastica*

1 u.m.vta  
12 box

REF. 03398

Großer Aluminium-  
Quetscher  
*Spremitubo acciaio, grande*

1 u.m.vta  
10 box

REF. 01496



## Tuben quetsche Spremitubo

FarGrandee Tubenpresse  
*Spremitubo colorato*

60 u.m.vta  
60 box

REF. 01386



Beutel 10 Metallquetschen  
*Confezione da 10 spremitubo in metallo*

1 u.m.vta  
12 box

REF. 02590



Beutel 1 schwarzer Metallquetsche  
*Sacchetto da 1 spremitubo in metallo nero*

12 u.m.vta  
240 box

REF. 03521



## Schachtel mit 200 verschweißten Spezialstreifen für Strähnen Confezione da 200 fogli termici per meches



REF. 04679



REF. 04679/53



REF. 04679/54

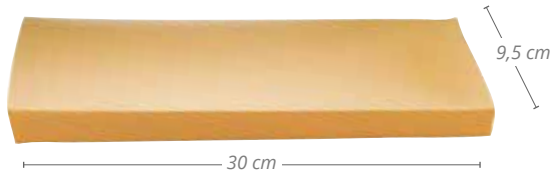

- » 200 Schaumstreifen
- » Widerstandsfähig - leicht - flexibel - thermisch
- » Für schnelles und einfaches Einfärben
- » Erzielen Sie optimale Ergebnisse mit Eurostil-Schaumstreifen
- » Sie ermöglichen es Ihnen, den Farbstoff näher an der Wurzel aufzutragen und die gewünschte Farbe zu erhalten.
- » Hilft, die Glanzeffekte verschiedener Schattierungen mit der Farbe des Papiers, Weiß, Gold und Silber, zu unterscheiden

### JEDE FARBE DES PAPIERS WIRD EINER FARBE DER STRÄNDE ENTSPRECHEN:

- » Bei langen Haaren legen Sie einen Streifen unter die Strähne, tragen Sie den Farbstoff auf und falten Sie ihn zusammen, indem Sie die beiden Enden verbinden.
- » Keine Notwendigkeit, die Seiten der Streifen zu biegen
- » Die thermischen Eigenschaften der Eurostil-Streifen beschleunigen den Färbe- oder Verfärbungsprozess. Überprüfen Sie die Entwicklung regelmäßig
- » Selbstklebend: Sie ermöglichen es Ihnen, den Prozess so oft zu kontrollieren, wie Sie wollen

- » 200 fogli in polietilene
- » Resistenti · leggere · flessibili · termiche
- » Per una colorazione facile e veloce
- » Ottieni risultati ottimali con le fogli in polietilene Eurostil
- » Ti permettono di applicare il colore più vicino alla radice e ottenere il colore desiderato
- » Aiutano a differenziare le mechas di diverse tonalità con il colore della carta, bianco, oro e argento
- » Ogni colore della carta corrisponde a un colore delle mechas

### CONSIGLI PRATICI PER L'USO:

- » Per i capelli lunghi, posizionare un foglio sotto la ciocca, applicare la tintura e piegarla unendo le due estremità
- » Non è necessario applicare il colore piegare i lati delle fogli
- » Le proprietà termiche delle fogli Eurostil accelerano il processo di colorazione o decolorazione. Controllare regolarmente lo sviluppo dell'effetto
- » Autoadesive: ti permettono di controllare il processo tutte le volte che vuoi

## Schachtel mit 100 Strähnen Spezialstreifen 0,8 mm Confezione da 100 fogli speciali per meches 0,8mm



100 Streifen = 63 gr

100 fogli = 63 gr

REF. 03338



### Schachtel mit 250 großen 1,1 mm Super-Strähnenblättern Confezione da 250 fogli grandi per supermeches 1,1mm

- » Dicke: 1,1 mm
- » Spessore: 1,1 mm



REF. 01874



### Schachtel 100 Stk. Transparent Blätter Confezione da 100 clip trasparenti

Da sie transparent sind, ermöglichen sie es Ihnen, den Prozess mit "bloßem Auge" zu verfolgen, ohne sie öffnen und schließen zu müssen. Dank seines Klebesystems kommt man näher an die Wurzel und es gibt keine Lecks.

Essendo trasparenti, permettono di seguire il processo ad "occhio nudo", senza la necessità di aprire e chiudere. Grazie al loro sistema adesivo non ci sono perdite, essendo più vicine alla radice.



REF. 01025



### Digitale Zeitschaltuhr Timer digitale

- » Spannung 9V~
- » Mit Magnethalter
- » Voltaggio 9V~
- » Con supporto e calamita



REF. 02539/50



### Zeitschaltuhr Timer



REF. 01975



### Digitale EUROSTIL-Waagen Bilance digitali EUROSTIL

- » Spannung 9V~
- » LCD-Anzeige
- » Messbereich bis zu 5 kg
- » Maßeinheit 1 g
- » Maßeinheiten einstellbar auf Kilogramm oder Pfund
- » Tara-Funktion (Bruttogewicht mit Tara-Speicher)
- » Große, stabile Glasauflageplatte für genaues Wiegen
- » Batterien nicht enthalten

- » Verchromte Waage
- » Bilancia cromata

REF. 03337/54

- » Waage matt schwarz
- » Bilancia nera opaca

REF. 03337/50



### Digitale EUROSTIL-Waagen

#### Bilancia digitali EUROSTIL



- » Modernes Design
- » Fassungsvermögen: 5 kg / 11 lbs: 0,4 oz / 176 oz / 5 L
- » Skala: 1gr / 0,1oz / 1 ml
- » Tara-Funktion
- » Automatische Abschaltfunktion
- » Anzeige des Batteriestatus
- » Vier verschiedene Maßeinheiten: g / lb:oz / oz / ml
- » Stromversorgung durch CR2032-Lithiumbatterie (nicht enthalten)

- » Design moderno
- » Capacità: 5 kg / 11 libbre: 0,4 once / 176 once / 5 L
- » Scala: 1gr / 0,1 once / 1 ml
- » Funzione di tara
- » Funzione di spegnimento automatico
- » Indicatore di stato della batteria
- » Quattro diverse unità di misura: g / lb:oz / oz / ml
- » Funziona con batteria al litio CR2032 (non incluso)

- » Schwarze runde digital Waage
- » Bilancia digitale rotonda nera

REF. 04803/50

- » Weiße runde digital Waage
- » Bilancia digitale tonda bianca

REF. 04803/58



- » Schwarze rechteckige Digitalwaage
- » Bilancia digitale rettangolare nera

REF. 04804/50

- » Weiße rechteckige Digitalwaage
- » Bilancia digitale rettangolare bianca

REF. 04804/58



### TASSEL Digitalwaage

#### Bilancia digitale TASSEL



- » Rund
- » Rotonda

REF. 06631





### Haarfärbeschale Anti-Rutsch Vaschetta graduata con gomma antiscivolo

32  
u.m.v.a. 32  
box

» Standard Farben  
» Colori standard

300 ml

REF. 00647

» Schwarz  
» Nero

300 ml

REF. 00647/50



» Klassische Farben  
» Colori classici

300 ml

REF. 00647/98



### Haarfärbeschale Anti-Rutsch Vaschetta con gomma antiscivolo

32  
u.m.v.a. 32  
box

» Transparent  
» Trasparente

300 ml

REF. 00647/56

» Durchsichtig  
» Semilucida

300 ml

REF. 00647/76



## Färbeschüssel Vaschetta per la tintura

72  
u.m.vta 72  
box

- » Klein
- » Standardfarben

300 ml

REF. 00654

- » Klein
- » Schwarz

300 ml

REF. 00654/50

- » Piccola
- » Colori standard

- » Piccola
- » Nero



11,5 cm

11,5 cm

72  
u.m.vta 72  
box48  
u.m.vta 48  
box

- » Klein klassische  
Farben

300 ml

REF. 00654/98

- » Groß
- » Durchsichtig

600 ml

REF. 00655/56

- » Piccola
- » Colori classici

- » Grande
- » Semilucida



11,5 cm

14,5 cm

48  
u.m.vta 48  
box

- » Groß
- » Standard Farben

600 ml

REF. 00655

- » Groß
- » Schwarz

600 ml

REF. 00655/50

- » Grande
- » Colori standard

- » Grande
- » Nero



14,5 cm

14,5 cm



**Haarfärbeschale Anti-Rutsch "TERRAZA"**  
**vaschetta antiscivolo "TERRAZA"**48  
u.m.vta48  
box» Durchsichtig  
» Semilucida

550 ml

550 ml

REF. 03696

REF. 03696/50

**TASSEL "TERRAZA"- Schale**  
**Vaschetta TASSEL "TERRAZA"**48  
u.m.vta48  
box**Haarfärbeschale mit Griff**  
**Vaschetta graduata con manico**40  
u.m.vta40  
box

550 ml

250 ml

REF. 06426

REF. 02340

**Haarfärbeschale mit rutschfestem Gummi und Griff**  
**Vaschetta graduata con gomma antiscivolo e manico**40  
u.m.vta40  
box

» Durchsichtig

» Metallic Farben

» Semilucida

250 ml

250 ml

REF. 02341

REF. 02341/97

» Colori metallizzati



### SAVE abgestufte Haarfärbeschale Vaschetta graduata SAVE

20  
u.m.vta

20  
box

Plastikschale, die mit einem gestuften Teil versehen ist, um die Menge des Produkts nach Ihren Bedürfnissen zu definieren und so die Entnahme des Produkts zu erleichtern.

*Vaschetta in plastica provvista di una parte graduata per stabilire la quantità di prodotto necessaria, facilitandone così la rimozione.*

600 ml

REF. 04967/50



REF. 04967

### Schale zum Färben und zum Aufhängen am Wagen Vaschetta per tintura da agganciare al carrello

Hängende Farbschale auf einer Fläche von maximal 1,5 cm Dicke. Praktisch für die Anwendung des Färbmittels, welches eine bequeme, schnelle und saubere Anwendung begünstigt. (Siehe Foto im Anhang).

*Vaschetta per tintura da agganciare in una superficie massima di 1,5 cm di spessore. Pratico per l'applicazione della tintura, favorendo un'applicazione comoda, veloce e pulita. (Vedi foto allegata).*

» Transparent  
» Transparente

8  
u.m.vta

8  
box

700 ml

REF. 01169

» Transparent  
» Transparente

14  
u.m.vta

14  
box

250 ml

REF. 01170



## Klein Färbepinsel · Pennelli colore, piccoli

Standard Farben  
Colori standard144  
u.m.vta144  
box1  
u.m.vta100  
box

REF. 00101/01

REF. 00101

Schüttgut  
SfusiEinzelverpackt  
Confezione individualeSchwarz, mit schwarzen Borsten  
Nero, con setole nere

REF. 00101/50/01

REF. 00101/50

Schüttgut  
SfusiEinzelverpackt  
Confezione individualeTransparent  
Transparente

REF. 00101/56/01

REF. 00101/56

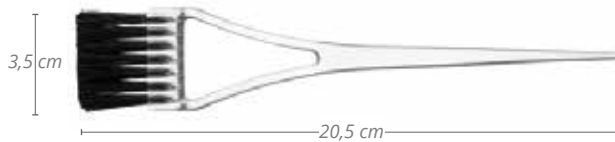
Schüttgut  
SfusiEinzelverpackt  
Confezione individualeMetallic Farben  
Colori metallizzati

REF. 00101/97

Einzelverpackt  
Confezione individualeFarben "klassisch"  
Colori "classici"

REF. 00101/98

Einzelverpackt  
Confezione individualeTransparent mit gefärbten Bündeln  
Trasparenti con setole colorate

REF. 00101/56/99

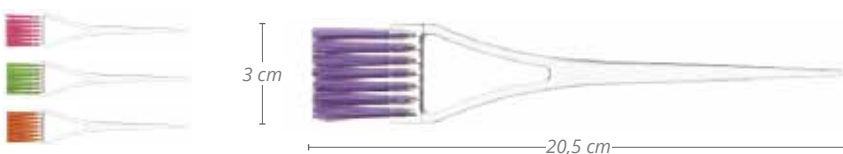
Einzelverpackt  
Confezione individuale

## Große Färbepinsel · Pennelli colore, grandi

72  
u.m.vta72  
box1  
u.m.vta50  
box

REF. 00102/01

REF. 00102

Schüttgut  
SfusiEinzelverpackt  
Confezione individualeSchwarz, mit schwarzen Borsten  
Nero, con setole nere

REF. 00102/50/01

REF. 00102/50

Schüttgut  
SfusiEinzelverpackt  
Confezione individualeTransparent  
Transparente

REF. 00102/56/01

REF. 00102/56

Schüttgut  
SfusiEinzelverpackt  
Confezione individuale

REF. 00102/97

Einzelverpackt  
Confezione individuale

REF. 00102/98

Einzelverpackt  
Confezione individuale

REF. 00102/56/99

Einzelverpackt  
Confezione individuale

**Dose 24 Färbepinsel mod.102**  
Confezione da 24 pennelli mod.102

REF. 04682

**"TERRACE"Pinzel durchscheinend**  
Pennello semilucido "TERRAZA"

REF. 03697/01

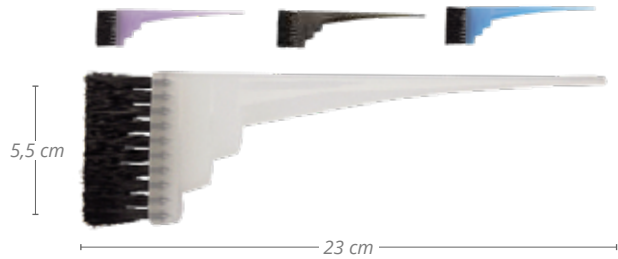

REF. 03697

Schüttgut  
SfusiEinzelverpackt  
Confezione individuale**TASSEL "TERRAZA" grosser Haarfärbepinsel**  
Pennello grande TASSEL "TERRAZA"

REF. 06425

**SOFTLY Haarfärbepinsel mit poliertem Stiel**  
Pennello con setole smussate SOFTLY

REF. 04654

Klein  
PiccoloEinzelverpackt  
Confezione individuale

REF. 04655

Groß  
GrandeEinzelverpackt  
Confezione individuale

**Großer Spezial Haarfärbepinsel**  
*Pennello grande, speciale per colore*

REF. 01335

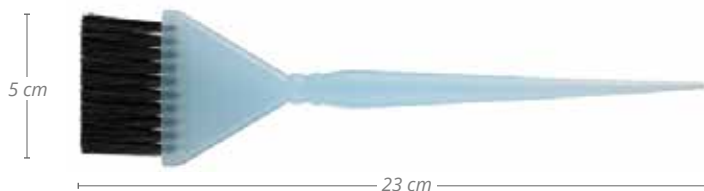
Einzelverpackt  
Confezione individuale**Mittelgrosser Spezial Haarfärbepinsel**  
*Pennello medio speciale per colore*

REF. 01280

Einzelverpackt  
Confezione individuale**Kleiner Haarfärbepinsel**  
*Pennello piccolo per colore*

REF. 01334

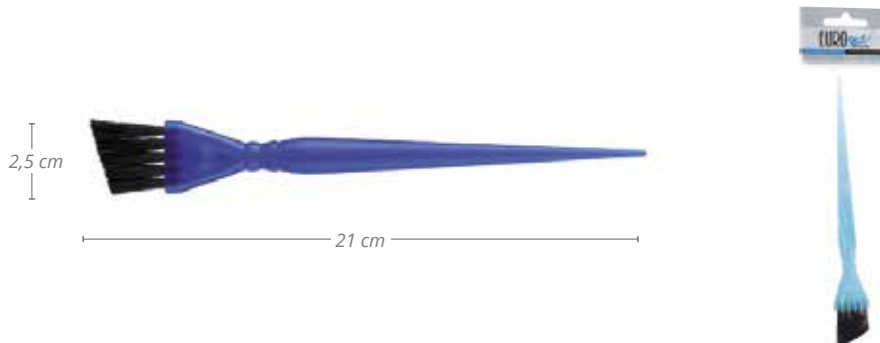
Einzelverpackt  
Confezione individuale**Haarfärbepinsel mit Stiel aus Kunststoff**  
*Spatola con punte in plastica*

REF. 03033

Einzelverpackt  
Confezione individuale



### Haarfärbe Silikonpinsel Spatola colore, in silicone



Silikonkissen für präziseren und schnelleren Farbauftrag:

- » Schnellere Anwendung
- » Näher an der Kopfhaut
- » Größere Produkteinsparungen

Spatola in silicone per l'applicazione del colore in modo più preciso e veloce:

- » Applicazione più veloce
- » Più vicino al cuoio capelluto
- » Maggiore risparmio sui prodotti

REF. 04297

- » Geradlinig und groß
- » Dritta e grande



Einzelverpackt  
Confezione individuale

- » Schräg und groß
- » Inclinata e grande



REF. 04298

Einzelverpackt  
Confezione individuale

- » Mittlere Spitzen
- » Punte medie



REF. 04299

Einzelverpackt  
Confezione individuale

### Haarfärbepinsel mit stumpfer Spitze aus Kunststoff Pennello a setole smussate in plastica



REF. 04739



Einzelverpackt  
Confezione individuale

### Haarfärbepinsel mit Kamm Pennello con pettine



REF. 02529/50



REF. 01128



## Nackenschutz Poggiatesta

- » Nackenschutz für Waschbecken
- » Poggiatesta per lavatesta



REF. 01464



- » Silikon mit Saugnäpfen
- » In silicone con ventose



REF. 03258



- » Sonderbecken Ondina
- » Lavatesta speciale Ondina



REF. 00979



- » Beutel 2 Stk. schwarze Waschbecken
- » Confezione 2 poggiatesta per lavatesta, neri



REF. 01363



- » Schwarzer Kunststoff-Nackenschutz
- » Poggiatesta, in plastica nera



REF. 02522/50



- » Nackenschutz weich
- » Lavatesta morbido



REF. 02370



- » Nackenschutz aus Silikon für Waschbecken
- » Poggiatesta in silicone, per lavatesta



REF. 04507/60



REF. 04507/59

Comfort



REF. 04507/62



## Messbecher mit Skala Misurino graduato

» Messbecher mit Skala  
» Misurino graduato

30  
u.m.vta

30  
box

150 ml

REF. 02530/50



» Modell TERRAZA  
» Modello TERRAZZA

32  
u.m.vta

32  
box

150 ml

REF.04285



» Mit Griff  
» Con manico

36  
u.m.vta

36  
box

100 ml

REF. 00609



24  
u.m.vta

24  
box

150 ml

REF. 00604



» Mit Griff  
» Con manico

16  
u.m.vta

16  
box

250 ml

REF. 00608

## Mischbecher mit Skala aus Kunststoff Shaker graduato in plastica

24  
u.m.vta

24  
box

160 ml

REF. 01846



18  
u.m.vta

18  
box

210 ml

REF. 01144



16  
u.m.vta

16  
box

350 ml

REF. 00978



## Messflasche / Applikator Applicatore

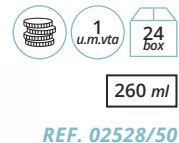
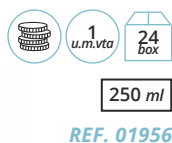
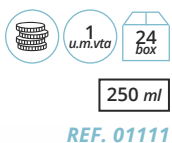
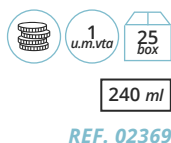
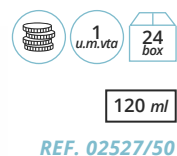

### Set mit 3 Trichtern in 3 Mini-Größen Set di 3 imbusti in 3 mini formati

» Für Parfümerie, Friseurhandwerk  
» Per profumeria, parrucchiere

REF. 00997

Ø: 3 cm

Ø: 4 cm

Ø: 5 cm



### Dosierlöffel Misurino



REF. 01164



### Aluminiumfolienrolle farGrande Rotolo di foglio di alluminio colorato

 8  
u.m.vta

 125 m  
Aprox

- » Bruttogewicht: 600 gr
- » Nettogewicht ohne Dorn: 537 gr
- » Dicke: 12 Mikrometer +/-

- » Peso lordo: 600 gr
- » Peso netto senza tubo: 537 gr
- » Spessore: 12 micron +/-

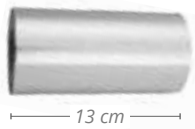

REF. 01113



REF. 01113/53



REF. 01113/59



REF. 01113/62



REF. 01113/60

- » Bruttogewicht: 475 gr
- » Nettogewicht ohne Dorn: 425 gr
- » Dicke: 15 Mikrometer +/-

- » Peso lordo: 475 gr
- » Peso netto senza tubo: 425 gr
- » Spessore: 15 micron +/-

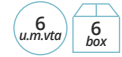
 6  
u.m.vta

 100 m  
Aprox

Mit einer sehr scharfen  
eingebauten Klinge  
Con lama per taglio molto  
affilata incorporata



REF. 02964



REF. 02964/53



REF. 02964/59



REF. 02964/62



REF. 02964/60

### Aluminium-Folienrolle Alufolienrolle Rotolo alluminio

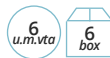
 6  
u.m.vta

- » Bruttogewicht: 600 gr
- » Nettogewicht ohne Dorn: 537 gr
- » Dicke: 10 Mikrometer +/-

- » Peso lordo: 600 gr
- » Peso netto senza tubo: 537 gr
- » Spessore: 10 micron +/-

 118 m  
Aprox

REF. 01139

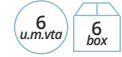

### Aluminium-Folienrolle Alufolienrolle Rotolo alluminio

 6  
u.m.vta

- Mit transparentem Streifen  
Con striscia trasparente

 60 m  
Aprox

REF. 02531

### PVC-Folienrolle Rotolo PVC con tubo

 6  
u.m.vta

 210 m  
Aprox

REF. 01198



## Geprägtes Aluminium Fogli di alluminio goffrato

- » 18 Mikrometer Silberaluminium, ausgezeichnete Qualität und Prägung
- » Mit Klebelasche und 200 Blatt
- » Dank seiner Prägung atmet das Haar mehr bei der Realisierung der Strähnen und Färbungen, für ein besseres Ergebnis der geleisteten Arbeit.

- » *Alluminio argentato brillante di alta qualità, 18 micron, goffrato*
- » *200 fogli con linguetta adesiva*
- » *Grazie alla goffratura, i capelli respirano di più quando si eseguono le meches e le tinture, favorendo un miglior risultato del lavoro svolto*



REF. 06079

- » Glanzsilberfarbenes Aluminium. Mit Klebelasche und 100 Blatt
- » Dank der Prägung des Aluminiums und seiner leichten visuellen Charakteristik erlaubt es, die geleistete Arbeit zu visualisieren, ohne das Papier öffnen und schließen zu müssen, was die Arbeit des Fachmanns erleichtert und beschleunigt.

- » *Alluminio argentato lucido. 100 fogli con linguetta adesiva*
- » *Grazie alla goffratura dell'alluminio, e alla sua caratteristica visual light, permette di visualizzare il lavoro in esecuzione senza la necessità di aprire e chiudere la carta, facilitando e velocizzando il lavoro del professionista*



REF. 06080

- » Hervorragende Qualität und geprägte, Aluminiumfolienrolle von etwa 18 Mikrometer und einem Bruttogewicht von 400 gr
- » Dank seiner Prägung atmet das Haar bei der Realisierung der Strähnen und Färbungen mehr, was ein besseres Ergebnis der durchgeführten Arbeit begünstigt
- » 9 Meter lang und 12 cm breit

- » *Rotolo di foglio di alluminio di ottima qualità e goffrato di circa 18 micron e peso lordo di 400 gr*
- » *Grazie alla goffratura, i capelli respirano di più quando si eseguono le meches e le tinture, favorendo un miglior risultato del lavoro*
- » *9 metri di lunghezza per 12 cm di larghezza svolto*



REF. 06081

- » Schachtel mit 300 Blatt
- » *Dispenser da 300 fogli*



REF. 06193



## Spender Dispenser



REF. 02426

## Schutzbeutel Protettori

- » Beutel 180 u.
- » Schutz für Brillen  
bügel

- » Sacchetto da 180 unità
- » Protettore per occhiali



REF. 03217

- » Beutel 50 Stk.
- » Schutzbeutel für die  
Stuhllehne

- » Sacchetto da 50 unità
- » Protezione per lo  
schienale della sedia

5,4 x 5,5 x 2,3 cm



REF. 03634

- » Schachtel 200 Stk. Handy-Schutz
- » Confezione da 200 unità Protettore cellulare



REF. 03633

- » Beutel 2 Stk. Ohrschutz
- » Sacchetto da 2 unità Protezione per le orecchie



REF. 01915



## Ohrschutz 50 Stk Protezione per le orecchie 50 unità

- » Abmessungen: 2\*4,5 cm
- » Gewicht: 0,40 gr
- » Material: Kunststoff

- » Dimensioni: 2\*4,5 cm
- » Peso: 0,40 gr
- » Materiale plastico



REF. 07008

## Beutel mit 100 Einweghandschuhen Confezione da 100 guanti monouso

NEW



REF. 07304



## Beutel mit 200 Plastikhandschuhen Confezione da 200 guanti di plastica



REF. 00963



**100 HANDSCHUHE PE zum einmaligen Gebrauch und für eine astreine Hygiene****100 Guanti pe monouso**

REF. 07257

- » Beidhändig
- » Einheitsgröße
- » Multifunktional

- » *Ambidestro consente a ciascun guanto di essere usato per qualsiasi mano*
- » *Taglia unica*
- » *Multiuoso*



NEW

**100 transparente Polyethylenhandschuhe****100 Guanti polietilene trasparenti**

REF. 07804

- » 100% reines Polyethylen HDPE 0,7+/2%g/pc
- » Hypoallergen, undurchlässig, Einheitsgröße
- » EPI Handelsklasse 1, angefertigt und gekennzeichnet CE
- » Kompatibel mit Lebensmittelgebrauch 2011/10/CE
- » 30 cm. hoch x 25 cm. Breit – Finger 15 cm breit Handgelenk

- » *Polietilene hdpe 100% 0,7 +/- 2% g / pz*
- » *Anallergici, impermeabile, taglia unica,*
- » *DPI di categoria 1, prodotti e marcati CE,*
- » *Compatibile con uso alimentare 2011/10 / CE*
- » *30 Cm altezza x 25 cm larghezza x 15 larghezza polso 15*



NEW

**Beutel 2 Stk. professionelle Handschuhe****Sacchetto 2 unità guanti professionali**

- » Material: Gummi
- » *Materiale: gomma*

6,5  
Talla / Size

REF.01672

7  
Talle / Size

REF.01673

7,5  
Talla / Size

REF.01674

8  
Talla / Size

REF.01675

**Box 100 schwarze Nitril-Handschuhe****Scatola da 100 guanti in nitrile nero**NITRIL / NITRILE  
AQL 1,5

- » *Ohne Pulver*  
SENZA polvere



S

REF. 06686

M

REF. 06687

L

REF. 06688



### Karton 50 synthetische Handschuhe

#### Confezione da 50 guanti sintetici



Ohne Pulver  
SENZA polvere

- » Verbindet die Flexibilität von Latex und die Elastizität des geruchslosen Vinyls.
- » Gefühl einer zweiten Haut, dank ihrer elastischen Eigenschaften, sehr ähnlich wie beim Latex, und bietet die hypoallergenen Eigenschaften des Vinyls.
- » Material: PVC-Derivat.
- » Nicht steril
- » Farbe schwarz
- » Innen- und Außenoberfläche glatt
- » Geeignet für Latex-Allergiker

- » *Combinano la flessibilità del lattice e l'elasticità del vinile inodore.*
- » *Sensazione di seconda pelle grazie alle sue proprietà elastiche molto simili al lattice e alle proprietà ipoallergeniche del vinile.*
- » *Materiale: derivato del PVC*
- » *Non sterili*
- » *Colore nero*
- » *Superfici interne ed esterne lisce.*
- » *Adatti agli allergici al lattice.*

NEW



M

REF. 07263

L

REF. 07264

### Schachtel mit 20 schwarzen Latexhandschuhen

#### Confezione da 20 guanti in latex

LATEX / LATEX  
AQL 1,5

Ohne Pulver  
SENZA polvere



S

REF. 02832

M

REF. 02833

L

REF. 02834

### Schachtel mit 100 weißen Latexhandschuhen mit wenig Puder

#### Confezione da 100 guanti in latex bianco con poco talco

LATEX / LATEX  
AQL 1,5

S/M

REF. 01671

S/M

REF. 01669

S/M

REF. 01670

### Schachtel mit 100 Vinyl-Handschuhen

#### Confezione da 100 guanti in vinile

VINYL / VINILE  
AQL 1,5

Ohne Pulver  
SENZA polvere



S

REF. 02586

M

REF. 02587

L

REF. 02588

**Eurostil-Gummi Nackenumhang**  
 Coprispalle in gomma Eurostil

 1  
u.m.vta 24  
box

REF.01350

**BOB-TUO Gummi Nackenumhang**  
 Coprispalle in gomma BOB-TUO

 1  
u.m.vta 12  
box

REF.01082

**Professioneller Silikon Nackenumhang**  
 Coprispalle professionale in silicone

 1  
u.m.vta 24  
box

REF. 03735

**Nackenumhang mit magnetischem Verschluss**  
 Coprispalle con chiusura magnetica

 1  
u.m.vta 12  
box

REF.02496

**Professioneller Nackenumhang**  
 verstärkt  
 Coprispalle professionale rinforzato

 1  
u.m.vta 20  
box

REF.00666/50

**Nackenumhang mit magnetischem Verschluss**  
 Coprispalle con chiusura magnetica

REF. 02518/50

 1  
u.m.vta 12  
box

REF. 02519/50



REF. 02519/54

**Silikon Nackenumhang mit magnetischem Verschluss EUROSTIL**  
**Coprispalle con chiusura magnetica Coprispalle EUROSTIL in silicone**



REF.07006



**Professioneller Friseurumhang**  
**Coprispalle professionale**



- » Werkstoff: Nylon
- » Klett-Verschluss
- » Materiale: nylon
- » Chiusura in velcro

REF.02595/50

REF.02595/58

REF.02595/70

REF.02595/59



Ø: 80 cm



- » Werkstoff: Nylon
- » Klett-Verschluss
- » Materiale: nylon
- » Chiusura in velcro

REF.02598/68

REF.02598/64

REF.02598/75

Ø: 80 cm



115 cm

84 cm



### Beutel 50 einweschürzen Confezione 50 mantelle monouso

- » Material: PE
- » Dicke: ca. 18 Mikrometer
- » Gewicht pro Schürze 10 g
- » Schürze für nur einen Gebrauch
- » Ideal zum Schutz der Kleidung
- » Einmaliger Gebrauch für eine untadelige Hygiene

- » Materiale: PE
- » Spessore 18 micron circa
- » peso ogni grembiule 10g
- » Grembiule monouso ideale per proteggere i vestiti.
- » Monouso per un'igiene impeccabile



REF. 07266

NEW

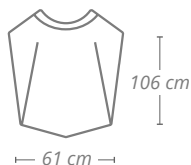

### Beutel mit 30 umhängen schwarz Confezione 30 mantelle monouso

- » Material: Polyethylen niedriger Dichte LDPE
- » Dicke des Kunststoffs 20 Mikrometer
- » Verschluss durch Schlaufe
- » Gewicht 340 g

- » Materiale: Polietilene LDPE a bassa densità
- » Spessore plastica 20 micron
- » Chiusura con laccio
- » Peso 340 g



REF. 01078

NEW



### Beutel 30 Capes schwarz confezione da 30 mantelline nere

- » Einmaligen Gebrauch
- » Monouso



REF. 07243

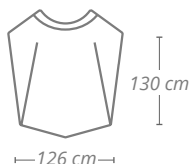

NEW



### Packung 50 Einweg Umhänge Confezione da 50 mantelline monouso

- » Material P.E
- » Schleifenverschluss
- » Dicke: ca. 12,5 Mikrometer

- » Materiale P.E
- » Chiusura con laccio
- » Spessore 12,5 micron circa



REF. 07806/50

REF. 07806/58

REF. 07806/59

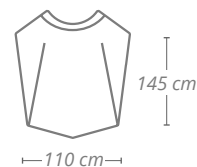

**CLASSIC-Beutel mit 30 Umhängen**  
Confezione da 30 mantelline CLASSIC

- » Material: Kunststoff
- » Schleifenverschluss
- » Dicke: ca. 14 Mikrometer

» Materiale: plastica

- » Chiusura con laccio
- » Spessore 14 micron circa

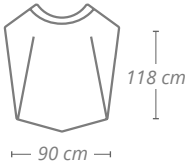

REF.02791/58



REF.02791/50



REF.02791/54



REF.02791/59



REF.02791/64



REF.02791/68



REF.02791/70



REF.02791/53

### Packung 50 Umhänge SIMPLE - Confezione da 50 mantelline SIMPLE



REF. 01207

- » Material: Kunststoff
- » Schleifenverschluss
- » Blau

» Materiale: plastica

- » Chiusura con laccio
- » Blu

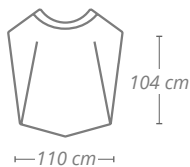

### Packung 30 Umhänge TASSEL Confezione da 30 mantelline TASSEL

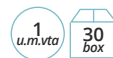

REF. 06427

- » Material: Kunststoff
- » Schleifenverschluss
- » Weiß

» Materiale: plastica

- » Chiusura con laccio
- » Bianco

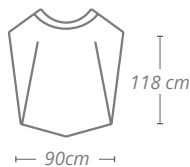

### Packung 50 Einweg Umhänge Confezione da 50 mantelline monouso



REF. 02456/58

REF. 02456/59

- » Material P.E
- » Schleifenverschluss
- » Dicke: ca. 12,5 Mikrometer

- » Materiale P.E
- » Chiusura con laccio
- » Spessore 12,5 micron circa

REF. 02456/60

REF. 02456/64

REF. 02456/68

REF. 02456/70

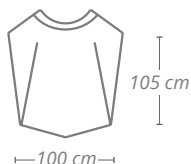

### Beutel mit 30 Umhängen in Weiß Confezione da 30 mantelline WHITE



REF. 06113/58

- » Material: Polyethylen
- » Schleifenverschluss
- » Dicke: ca. 11 Mikrometer  
Mit Aufhänger

- » Materiale: polietilene
- » Chiusura con laccio
- » Spessore 11 micron circa
- » Per appendere



**Rolle 50 Umhänge zum einmaligen Gebrauch**  
**Rotolo da 50 mantelline monouso**

12  
u.m.vta

12  
box

- » Material P.E
- » Schleifenverschluss
- » Dicke: ca. 12,5 Mikrometer

REF. 02792/58

REF.02792/50

- » Materiale P.E
- » Chiusura con laccio
- » Spessore 12,5 micron circa

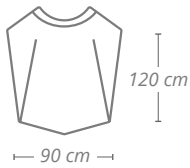

REF. 02792/59

**Cape Polyester schwarz, mit Ärmeln**  
**Mantellina in poliestere nero con maniche**

1  
u.m.vta

12  
box

- » Material:100% Polyester
- » Hakenverschluss

REF. 07122

- » Materiale: 100% poliestere
- » Chiusura a gancio



### MYSTERY Umhang Mantellina MISTERY

1  
u.m.vta

6  
box

- » Material: 76% Polyester, 24% P.U.
- » Klett-Verschluss
- » Wasserabweisend

REF. 02505/61

REF. 02505/69

- » Material: Kunststoff
- » Klett-Verschluss
- » Wasserabweisend

REF. 02506/50

- » Materiale: 76% poliester, 24% PU
- » Chiusura in velcro
- » Idrorepellente

- » Materiale: plastica
- » Chiusura in velcro
- » Idrorepellente

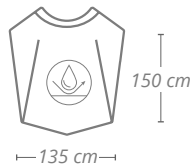
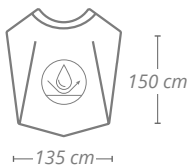

### FACES 2019 Umhang Mantellina FACES 2019

1  
u.m.vta

12  
box

- » Material: Polyester
- » Klett-Verschluss

REF. 02501/50

REF. 02501/73

- » Materiale: poliester
- » Chiusura in velcro

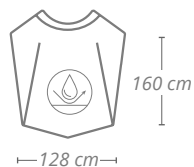



**LOOK Umhang**  
**Mantellina LOOK**1  
u.m.vta12  
box

- » Material: 100% Polyester
- » Bügelverschluss
- » Wasserabweisend
- » Antistatisch

- » Materiale: 100% poliestere
- » Chiusura con gancetti
- » Idrorepellente
- » Privo di elettricità statica

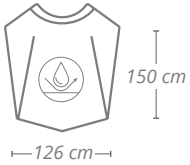

REF. 02504/75

REF. 02504/50

REF. 02504/68

**NIGHT Umhang**  
**Mantellina NIGHT**1  
u.m.vta12  
box

- » Material: Nylon
- » Knopf-Verschluss

- » Materiale: nylon
- » Chiusura a bottone

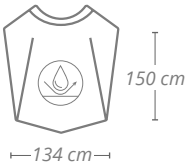

REF. 02503/50

REF. 02503/58

REF.02503/75



REF. 02503/72

REF. 02503/68

REF. 02503/62

REF. 02503/60



### SCISSORS-Umhang Mantellina SCISSORS

1  
u.m.vta

12  
box

- » Material: 100% PVC
- » Klett-Verschluss
- » Wasserabweisend

- » Materiale: 100% PVC
- » Chiusura in velcro
- » Idrorepellente

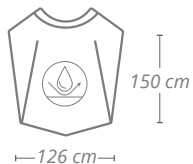

REF. 01842/68



REF. 01842/50

REF. 01842/59

REF. 01842/73



### MODELL Umhang Mantellina MODEL

1  
u.m.vta

12  
box

- » Material: 100% Polyester
- » Klett-Verschluss
- » Wasserabweisend

- » Materiale: 100% poliester
- » Chiusura in velcro
- » Idrorepellente

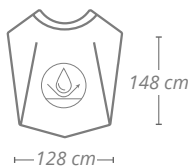

REF. 04303/50

REF. 04303/59

REF. 04303/72



### BOB-Umhang Mantellina BOB

1  
u.m.vta

12  
box

- » Material: Polyester
- » Klettverschluss
- » Wasserabweisend

REF. 02632/59

REF. 02632/72

- » Materiale: poliester
- » Chiusura con gancetti
- » Idrorepellente

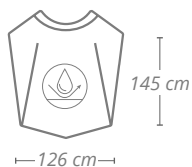

### FACES 2000 Umhang Mantellina FACES 2000

1  
u.m.vta

12  
box

- » Material: Nylon
- » Klett-Verschluss
- » Wasserabweisend

REF. 01961/50

REF. 01961/59

- » Materiale: nylon
- » Chiusura in velcro
- » Idrorepellente

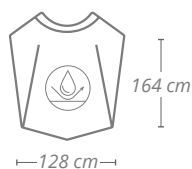

**EUROSTIL Umhang**  
**Mantellina EUROSTIL**1  
u.m.vta 12  
box

REF. 04257/50

- » Material: Nylon
- » Knopf-Verschluss

- » Wasserabweisend

- » Materiale: nylon
- » Chiusura a bottone
- » Idrorepellente

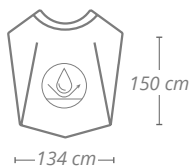
**BEAUTY Umhang**  
**Mantellina BEAUTY**1  
u.m.vta 12  
box

REF. 04311

- » Material: 100% Polyester
- » Klett-Verschluss
- » Wasserabweisend

- » Materiale: 100% poliestere
- » Chiusura in velcro
- » Idrorepellente

**PLACTON Umhang für Färbearbeiten**  
**Mantellina PLACTON**1  
u.m.vta 50  
box

- » Werkstoff: PVC
- » Klett-Verschluss

- » Materiale: PVC
- » Chiusura in velcro

REF. 01988/73

REF. 01988/50

REF. 01988/59

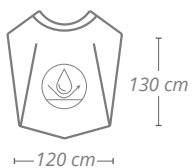

### ANIMAL PRINT Umhang

#### Mantellina ANIMAL PRINT

1  
u.m.vta

12  
box

- » Werkstoff: Nylon
- » Klett-Verschluss

- » Materiale: nylon
- » Chiusura in velcro

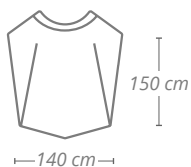

REF. 02502/58



REF. 02502/61

- » Werkstoff: Nylon
- » Klett-Verschluss

- » Materiale: nylon
- » Chiusura in velcro

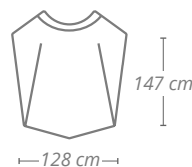

REF. 03522



REF. 03523



### ZEBRA Umhang

#### Mantellina ZEBRA

1  
u.m.vta

12  
box

- » Werkstoff: Nylon
- » Klett-Verschluss

- » Materiale: nylon
- » Chiusura in velcro

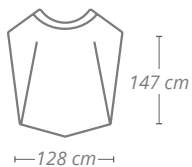

REF. 03524



### DAY Umhang Mantellina DAY

- » Material: 65% Polyester
- » 35% Baumwolle
- » Klettverschluss

- » Materiale: 65% poliestere 35% cotone
- » Chiusura in velcro

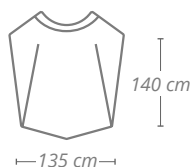

REF. 01077/58

REF. 01077/50



### ELEGANT Umhang Mantellina ELEGANT

- » Material: 100% Polyester
- » Klett-Verschluss

- » Materiale: 100% poliestere
- » Chiusura in velcro

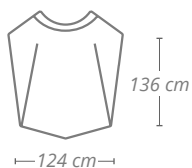

REF. 01175/60

REF. 01175/50



REF. 01175/58

REF. 01175/59

REF. 01175/72



### BROSS-Umhang Mantellina BROSS

» Material: Kunststoff  
» Klett-Verschluss

» Materiale: plastica  
» Chiusura in velcro

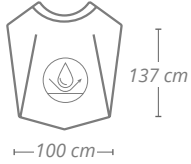

REF. 01228

» Material: Kunststoff  
» Klett-Verschluss

» Materiale: plastica  
» Chiusura in velcro

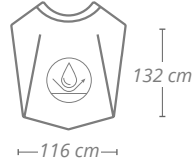

REF. 01774



### LIGHTS Umhang Mantellina LIGHTS

» Material: Nylon  
» Knopf-Verschluss

» Materiale: nylon  
» Chiusura a bottone

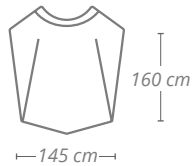

REF. 04877/54

REF. 04877/63

REF. 04877/68



**STYLE Umhang**  
**Mantellina STYLE**1  
u.m.vta50  
box

- » Material: Nylon
- » Knopf-Verschluss

- » Materiale: nylon
- » Chiusura a bottone

REF. 04876/68

REF. 04876/50

REF. 04876/58

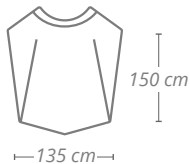
**FUNNY Umhang**  
**Mantellina FUNNY**1  
u.m.vta50  
box

- » Material: Polyurethan und Polyester
- » Knopf-Verschluss
- » Wasserabweisend

- » Materiale: poliuretano e poliestere
- » Chiusura a bottone
- » Idrorepellente

REF. 04879/50

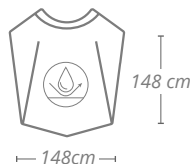
**GirovitaLINE Umhang**  
**Mantellina GirovitaLINE**1  
u.m.vta12  
box

- » Material: 65% Polyester, 35% Baumwolle
- » Klett-Verschluss
- » Schneiden und Färben

- » Materiale: 65% poliestere, 35% cotone
- » Chiusura in velcro
- » Taglio e tintura

REF. 01076/50

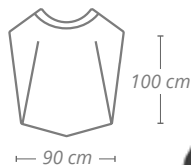



### Schwarzer Mantel Camice nero



REF. 04301

- » Material: 100% Polyester
- » Knopf-Verschluss

- » Materiale: 100% poliestere
- » Chiusura a bottone



Schulter: 47 cm  
Ärmel: 25 cm  
Büste: 117 cm  
Länge: 72 cm

Spalle: 47 cm  
Manica: 25 cm  
Giro del busto:  
117 cm  
Lunghezza: 72 cm

### Kimono Kimono



REF. 04300

- » Material: 100% Polyester
- » Knopf-Verschluss

- » Materiale: 100% poliestere
- » Chiusura a bottone



Schulter: 70 cm  
Büste: 122 cm  
Länge: 106 cm

Spalle: 70 cm  
Giro del busto:  
122 cm  
Lunghezza:  
106 cm

### Transparente Schürze Grembiule trasparente



REF. 01929

- » Material: Durchsichtiges PVC
- » Schleifenverschluss
- » Schwarzer Rand
- » Wasserabweisend

- » Materiale: PVC trasparente
- » Chiusura con laccio
- » Bordo nero
- » Idrorepellente



### LONG Schürze Grembiule LONG



REF. 04880/50

- » Material: 100% Nylon
- » Schleifenverschluss
- » Wasserabweisend
- » Schwarz

- » Materiale: 100% nylon
- » Chiusura con laccio
- » Idrorepellente
- » Nero

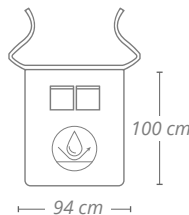

### Schwarze Schürze Grembiule nero

- » Material: 100% Polyester
- » Schleifenverschluss
- » Wasserabweisend

- » Materiale: 100% poliestere
- » Chiusura con laccio
- » Idrorepellente

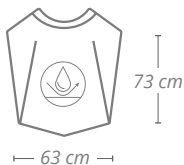

REF. 04305

### Schürze mit Tasche Grembiule con tasca

- » Material: 100% Polyester
- » Schleifenverschluss
- » Wasserabweisend

- » Materiale: 100% poliestere
- » Chiusura con laccio
- » Idrorepellente

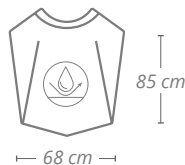

REF. 04302

### Arbeitsschürze Grembiule

- » Material: 24% Polyurethan, 76% Polyester
- » Klett-Verschluss
- » Wasserabweisend

- » Materiale: 24% poliuretano, 76% poliestere
- » Chiusura in velcro
- » Idrorepellente



REF. 02510/50

### Kinder-Umhang Katzen

#### Mantellina per bambini, gatti

1  
u.m.v.ta

12  
box

- » Material: 100% Polyester
- » Klett-Verschluss
- » Wasserabweisend

- » Materiale: 100% poliestere
- » Chiusura in velcro
- » Idrorepellente

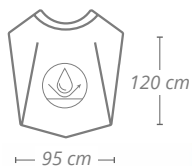

REF. 04313/68



REF. 04313/64



### Kinder-Umhang Enten

#### Mantellina per bambini, papere

1  
u.m.v.ta

12  
box

- » Material: 100% Polyester
- » Klett-Verschluss

- » Materiale: 100% poliestere
- » Chiusura in velcro

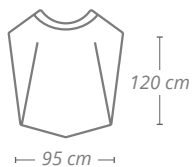

REF.02509/70



## Kinder-Umhang Hunde Mantellina per bambini, cani

- » Material: 100% Polyester
- » Klett-Verschluss

- » Materiale: 100% poliestere
- » Chiusura in velcro

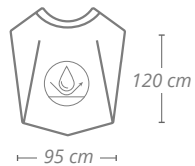

REF.02508/75



REF.02508/70



REF.02508/61



**Lustige Designs in verschiedenen Drucken und Farben**  
Disegni molto divertenti in diversi modelli e colori

## **Professionelle Berufsbekleidung** **Abbigliamento professionale**

\* Nicht verfügbar für Portugal  
\* Non disponibile per il Portogallo

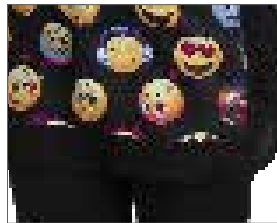

**[www.eurostil.com](http://www.eurostil.com)**



**Herz-Kasack**  
**Camice con cuori**1  
u.m.vta  
40  
box**MOD. 51605128**

Mini-Kasack mit Brustklammer und Mao-Kragen. Enthält 1 Vordertasche, 1 bedruckte Tasche und 1 unbedruckte Tasche. Geknüpft mit farGrandeen Knöpfen, tailliertes Kleidungsstück mit Clips und seitlichen Öffnungen.  
100% Polyester

*Camice con maniche ad aletta, clip sul petto e colletto alla coreana. 1 tasca frontale, 1 tasca color fantasia e un'altra in tinta unita. Chiusura con bottoni colorati, capo aderente con pinces e aperture laterali.*  
100% poliester

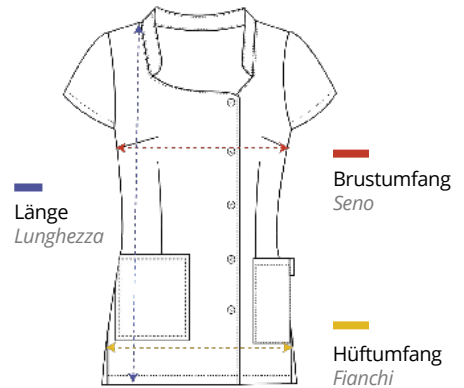

**S**  
98 - 102 cm  
102 - 106 cm  
72 - 74 cm

REF.06297/50/1

**M**  
106 - 110 cm  
108 - 112 cm  
73 - 75 cm

REF.06297/50/2

**L**  
114 - 118 cm  
116 - 120 cm  
75 - 77 cm

REF.06297/50/3

**XL**  
120 - 124 cm  
124 - 128 cm  
77 - 79 cm

REF.06297/50/4

**XXL**  
126 - 130 cm  
136 - 140 cm  
78 - 80 cm

REF.06297/50/5

**MOD. 51605128**

Mini-Kasack mit Brustklammer und Mao-Kragen. Enthält 1 Vordertasche, 1 bedruckte Tasche und 1 unbedruckte Tasche. Geknüpft mit farGrandeen Knöpfen, tailliertes Kleidungsstück mit Clips und seitlichen Öffnungen.  
100% Polyester

*Camice con maniche ad aletta, clip sul petto e colletto alla coreana. 1 tasca frontale, 1 tasca color fantasia e un'altra in tinta unita. Chiusura con bottoni colorati, capo aderente con pinces e aperture laterali.*  
100% poliester

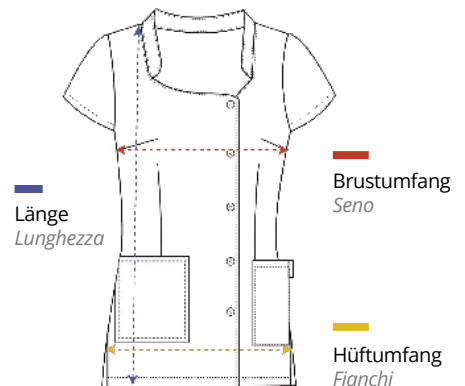

**S**  
98 - 102 cm  
102 - 106 cm  
72 - 74 cm

REF.06297/58/1

**M**  
106 - 110 cm  
108 - 112 cm  
73 - 75 cm

REF.06297/58/2

**L**  
114 - 118 cm  
116 - 120 cm  
75 - 77 cm

REF.06297/58/3

**XL**  
120 - 124 cm  
124 - 128 cm  
77 - 79 cm

REF.06297/58/4

**XXL**  
126 - 130 cm  
136 - 140 cm  
78 - 80 cm

REF.06297/58/5

**Frauen Kasack farGrande**  
**Camice colorato**

1 u.m.vta 40 box

MOD. 51505003

Brust- und Rücken Kasack mit quadratischem Dekolleté. Diagonaler Druck mit YKK-Reißverschluss und einer Tasche. Passendes Kleidungsstück mit Falten und Seitenschlitzen. 100% Polyester

*Camice con pinces sul petto e sulla schiena e scollatura quadrata. Fantasia in diagonale con zip YKK, giromanica e una tasca. Capo aderente con pinces e aperture laterali. 100% poliester*



Länge  
Lunghezza

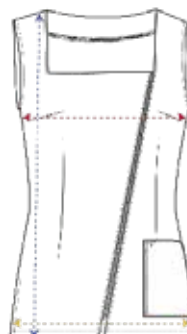

Brustumfang  
Seno

Hüftumfang  
Fianchi

S

88-92 cm  
100-104 cm  
69-71 cm

REF.06296/50/1

M

94-98 cm  
100-108cm  
71-73 cm

REF.06296/50/2

L

102-106 cm  
110-114 cm  
73-75 cm

REF.06296/50/3

XL

108-112 cm  
120-124 cm  
74-76 cm

REF.06296/50/4

XXL

118-122 cm  
130-134 cm  
75-77 cm

REF.06296/50/5

**Kasack Lippenstift mit Reißverschluss**  
**Camice fantasia rossetto con zip**

1 u.m.vta 40 box

MOD. 51308060

Kasack mit Brustverschluss, Rücken und Dekolleté quadratischem Ausschnitt. 1 bedruckte Vorderseite, seitlicher YKK-Reißverschluss, und eine Tasche, tailliertes Kleidungsstück mit Abnähern und Seitenschlitzen.

*Camice con pinces sul petto e sulla schiena e scollatura quadrata. 1 stampa fantasia frontale, cerniera YKK, giromanica e tasca a filetto, capo aderente con pinces e aperture laterali.*



Länge  
Lunghezza

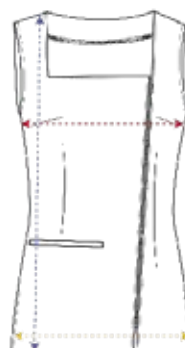

Brustumfang  
Seno

Hüftumfang  
Fianchi

S

88-92 cm  
100-104 cm  
69-71 cm

REF.06299/50/1

M

94-98 cm  
100-108cm  
71-73 cm

REF.06299/50/2

L

102-106 cm  
110-114 cm  
73-75 cm

REF.06299/50/3

XL

108-112 cm  
120-124 cm  
74-76 cm

REF.06299/50/4

XXL

118-122 cm  
130-134 cm  
75-77 cm

REF.06299/50/5

**Kasack farGrandee Kreise**  
**Camice a pois colorati**1 u.m.vta  
40 box

MOD. 51505005

Einfache ärmelloser Kittel mit bedrucktem Streifen. YKK-Reißverschluss an der Seite. Zusammensetzung 100% Polyester. Zwei Taschen, eine auf der Taille und eine auf der Brust. Empfohlen für Geschäfte und Schönheitssalons.

Camice colorato basic con fascia stampata. Chiusura con zip YKK sul lato. Materiale: 100% poliestere Due tasche, una in vita e una sul petto. Consigliato per negozi e centri estetici.

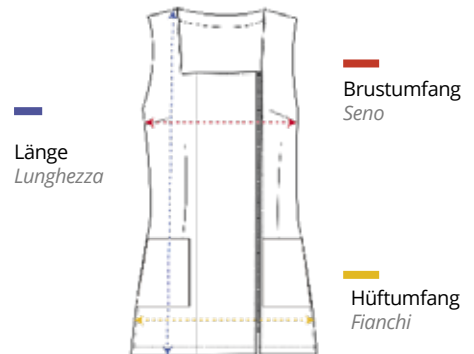

S

88-92 cm  
100-104 cm  
69-71 cm

REF. 06304/50/1

M

94-98 cm  
100-108cm  
71-73 cm

REF. 06304/50/2

L

102-106 cm  
110-114 cm  
73-75 cm

REF. 06304/50/3

XL

108-112 cm  
120-124 cm  
74-76 cm

REF. 06304/50/4

**Kasack schwarz**  
**Camice nero**1 u.m.vta  
40 box

MOD. 51605126

Einfache ärmelloser Kittel mit bedrucktem Streifen. YKK-Reißverschluss an der Seite. Zusammensetzung 100% Polyester. Zwei Taschen, eine auf der Taille und eine auf der Brust. Empfohlen für Geschäfte und Schönheitssalons.

Camice colorato basic con fascia stampata. Chiusura con zip YKK sul lato. Materiale: 100% poliestere Due tasche, una in vita e una sul petto. Consigliato per negozi e centri estetici.

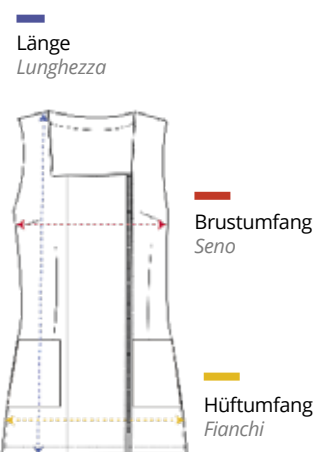

S

88-92 cm  
100-104 cm  
69-71 cm

REF. 06556/50/1

M

94-98 cm  
100-108cm  
71-73 cm

REF. 06556/50/2

L

102-106 cm  
110-114 cm  
73-75 cm

REF. 06556 /50/3

XL

108-112 cm  
120-124 cm  
74-76 cm

REF. 06556 /50/4

XXL

118-122 cm  
130-134 cm  
75-77 cm

REF. 06556/50/5



**Kasack Kurzärmel aus Polyester mit Reißverschluss**  
**Camice in poliestere a manica corta con zip**

1 u.m.vta  
40 box

MOD. 51308455N

Die Maße sind annähernd und gehören zum fertigen Kleidungsstück der Gesamtkontur. Sie müssen zwischen 4 und 6 cm je nach Größe der Person für den losen Sitz hinzufügen.

*Le misure sono approssimative e riguardano il perimetro complessivo del capo. Alla misura della persona bisogna si devono invece aggiungere tra i 4 e i 6 cm per un uso confortevole.*

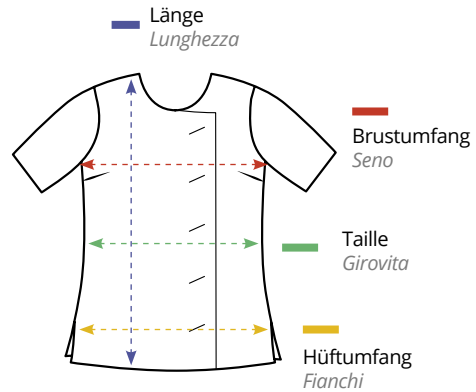

XS	S	M	L	XL	2XL
86 cm	92 cm	98 cm	106 cm	114 cm	122 cm
92 cm	98 cm	104 cm	111 cm	119 cm	127 cm
71 cm	72 cm	73 cm	74 cm	76 cm	77 cm
82 cm	88 cm	93 cm	101 cm	109 cm	116 cm
REF.07146/1	REF.07146/2	REF.07146/3	REF.07146/4	REF.07146/5	REF.07146/6

**Kasack Ärmellos mit Gesicht**  
**Camice senza maniche fantasia viso**

1 u.m.vta  
40 box

MOD. 51805322

Die Maße sind annähernd und gehören zum fertigen Kleidungsstück der Gesamtkontur. Sie müssen zwischen 4 und 6 cm zur Größe je Person für den losen Sitz hinzufügen.

*Le misure sono approssimative e riguardano il perimetro complessivo del capo. Alla misura della persona si devono invece aggiungere tra i 4 e i 6 cm per un uso confortevole.*



XS	S	M	L	XL	2XL
90 cm	96 cm	102 cm	110 cm	118 cm	126 cm
98 cm	104 cm	110 cm	117 cm	125 cm	133 cm
71 cm	72 cm	73 cm	74 cm	76 cm	77 cm
83 cm	89 cm	95 cm	102 cm	110 cm	118 cm
REF.07145/1	REF.07145/2	REF.07145/3	REF.07145/4	REF.07145/5	REF.07145/6

## Frauen Kittelschürze Stola / Herzen Camice fantasia cuori / silhouette

Enganliegende Kittel mit rundem Halsausschnitt und Armausschnitten in lebendigen bunten Farben. Einfaches Vorderteil mit zentraler bedruckter Teilungstasche, abgerundetem Saum und Taillen Anpassung mit Bändern, die über den Rücken laufen und in der Taille geknotet werden. 100% Polyester

*Camice aderente dai colori accesi e giromanica semplice. Parte frontale superiore in tinta unita con tasca divisoria con stampa centrale, orli stondati e regolazione del girovita con fasce che passano dalla schiena e si allacciano in vita. 100% poliestere*



MOD. 21502006  
REF.06305/50

MOD. 21602109  
REF.06306/50

MOD. 21304421  
REF.06307/50

MOD. 21502001  
REF.06308/50

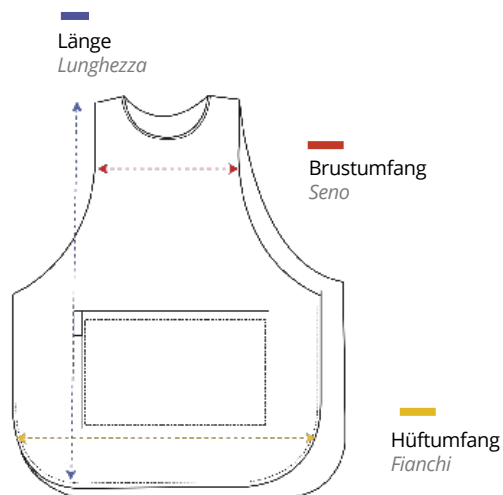

35 cm  
50 cm  
77 cm

**Schürzenkittel bedruckt**  
**Grembiuli con stampe**

1 u.m.vta  
40 box

MOD.21602130

Schürzenkittel, Einheitsgröße für alle. Schürzenkittel Größe A.  
Grembiule, taglia unica, regolabile secondo le esigenze. Grembiule taglia A.



MOD. 21902326

Aufdruck Gesicht  
Stampa con viso

REF.07140



MOD. 21802219

Herzen Vielfalt  
Multi-cuori

REF.07144



MOD. 21902325

Comic  
Comic

REF.07141

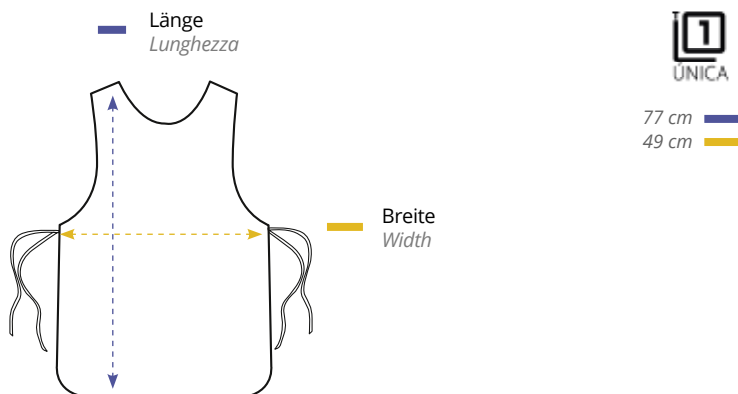

**Schürzenkittel bedruckt**  
**Grembiuli con stampe**

MOD.21602130

Schürzenkittel, Einheitsgröße für alle. Schürzenkittel Größe A.  
Grembiule, taglia unica, regolabile secondo le esigenze. Grembiule taglia A.

MOD. 21802218

Strähnen  
Meches

REF.07143



MOD. 21802233

Gefärbtes Haar  
Capelli colorati

REF.07142



MOD. 21802217

Nagellack  
Smalto per unghie

REF.07148

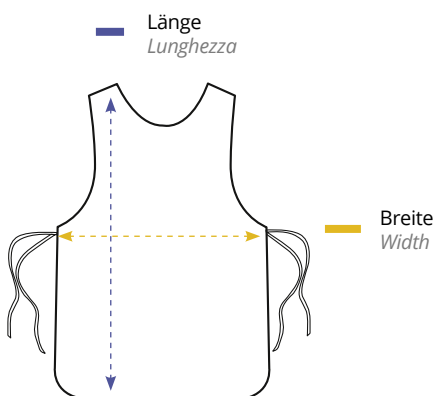
77 cm  
49 cm

**Schürzenkittel Stretch aus 100% Polyester**  
**Grembiule elasticizzato 100% poliestere**



MOD. 21602124

Schürzenkittel Stretch aus 100 % Polyester mit Rückenschlaufen und großen, bequemen Vordertaschen. Rosa pinkfarbener Rand.

Grembiule 100% poliestere elasticizzato, regolabile con fiocco e dotata di ampie e comode tasche frontali.



Länge  
Lunghezza

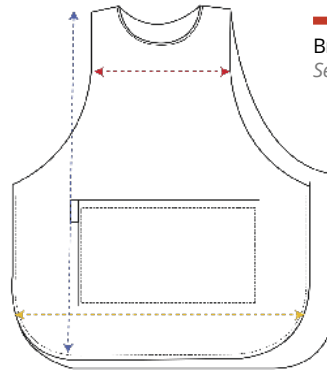

Brustumfang  
Seno

Hüftumfang  
Fianchi



35/36 cm  
50/51 cm  
77/78 cm

REF.06554/58



MOD. 21602124

100% Polyester  
100% poliestere



Länge  
Lunghezza

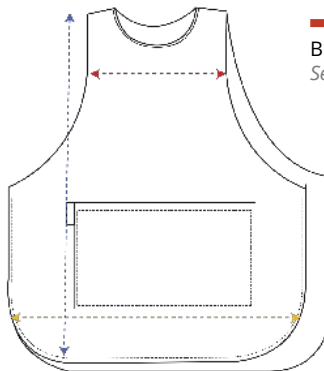

Brustumfang  
Seno

Hüftumfang  
Fianchi



35/36 cm  
50/51 cm  
77/78 cm

REF.06554/50

**Transparente Schürze/schwarz**  
**Grembiule trasparente/nero**1 u.m.vta  
40 box

MOD. 31306075

Schürzenkittel Stretch aus 100 % Polyester mit Rückenschlaufen und großen.

Grembiule 100% poliestere elasticizzato, regolabile sul dietro con fiocco e dotata di ampie tasche

67/68 cm  
79/180 cm

REF.06555

Hüfte  
FianchiLänge  
Lunghezza**Schürzenkittel mit Mao-Kragen**  
**Camice con colletto coreano**1 u.m.vta  
40 box

MOD.21602130

Schürzenkittel mit Mao-Kragen mit Metall-Druckknöpfen, Mini-Ärmeln und Front mit Seitentaschen. Er hat Bänder, die über den Rücken verlaufen und in der Taille gebunden werden.

Camice con colletto alla coreana con bottoni in metallo, maniche ad aletta, e bottoni e tasche frontali. È regolabile con fasce che attraversano la schiena e annodate in vita.

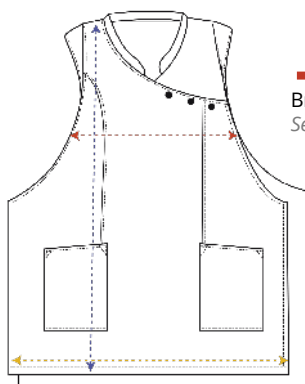
Länge  
LunghezzaBrustumfang  
SenoHüftumfang  
Fianchi100% Polyester  
100% poliestere

REF.06309/50

36/37 cm  
59/60 cm  
75/76 cm

**Stretch Kittelschürze aus 100% Polyester**  
**Grembiule elasticizzato 100% poliestere**

1 u.m.vta  
40 box

Stretch Kittel aus 100 % Polyester mit nach hinten passender Schleife und großen, bequemen Vordertaschen  
 Stola 100% poliestere elasticizzata regolata dietro con nastro e dotata di Grande e comode tasche frontali



MOD. 21304601

REF.06553/50

MOD. 21304601

REF.06553/58

MOD. 21304601

REF.06553/63

MOD. 21304601

REF.06553/68

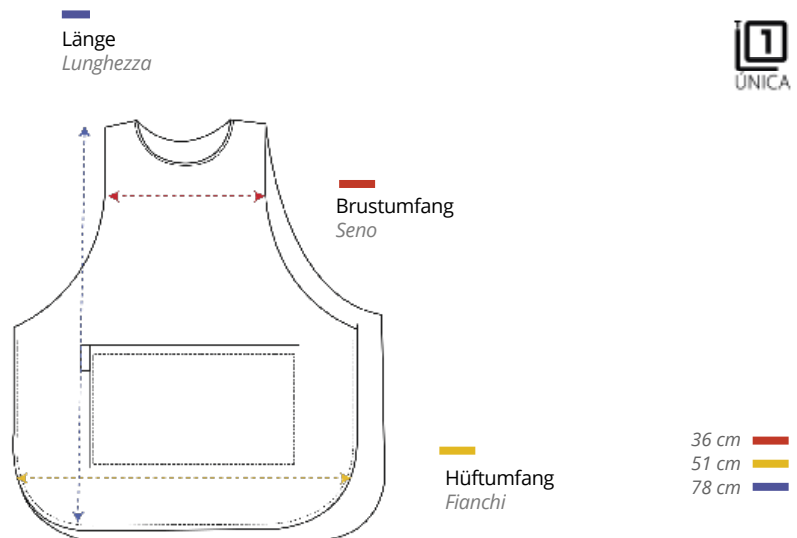

**Emoticons Schürzenkittel**  
**Grembiule emoticon**

1 u.m.vta 40 box

MOD. 21602143

Enger Kittelmit Rundhalsausschnitt. Einfaches Vorderteil mit bedruckter Trenntasche in der Mitte, abgerundetem Saum und Taillenanpassung mit Bändern, die über den Rücken laufen und in der Taille geknotet werden. 100% Polyester.

*Grembiule aderente con scollo tondo. Parte frontale superiore in tinta unita con tasca divisoria con stampa centrale, orli stondati e regolazione del girovita con fasce che passano dalla schiena e si allacciano in vita. 100% poliester.*

36 cm  
51 cm  
78 cm

REF.06303/50

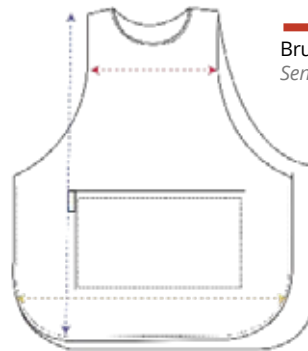
Länge  
LunghezzaBrustumfang  
SenoHüftumfang  
Fianchi**Antistatisches KIMONO**  
**KIMONO antistatico**

1 u.m.vta 40 box

MOD. 21300013

Gekreuzter Kimono mit Gürtel und 3/4-Arm mit Minitasche am Ärmel. Leicht zu bügeln. Verbleichschutz. 100% marokkanischer Polyester.

*Kimono con manica 3/4, cintura e mini tasca sulla manica. Facile da stirare. Non scolora. 100% poliester similpelle.*

123 cm  
123 cm  
106 cm

REF.06302/50

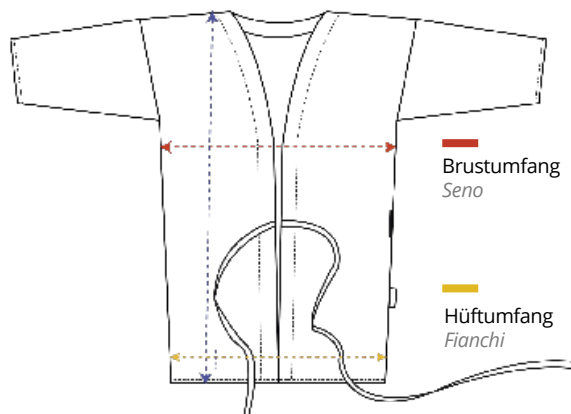
Länge  
LunghezzaBrustumfang  
SenoHüftumfang  
Fianchi



**Damen-Hosen**  
Pantaloni da donna

1 u.m.vta  
40 box

**MOD. 41300011N**

» Hose mit mittlerer Taille, hinten  
Elastikband mit 3 Schnüren  
» 100% Polyester

» Pantaloni a vita media, elastico  
posteriore con 3 lacci  
» 100% poliestere

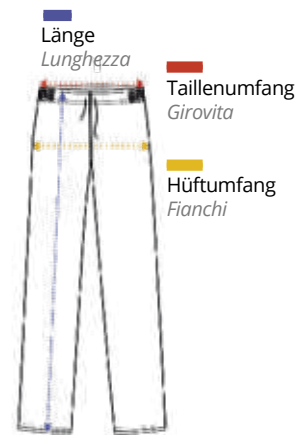

S

92-96 cm  
92-96 cm  
99-101 cm

REF.06312/50/1

M

98-102 cm  
96-100 cm  
101-103 cm

REF.06312/50/2

L

106-110 cm  
106-110 cm  
102-104 cm

REF.06312/50/3

XL

112-116 cm  
114-118 cm  
105-107 cm

REF.06312/50/4

**Damen-Hosen**  
Pantaloni da donna

1 u.m.vta  
40 box

**MOD. 41300011B**

» 67% Polyester  
» 33% Baumwolle

» 67% poliestere  
» 33% cotone



S

92-96 cm  
92-96 cm  
99-101 cm

REF.06312/58/1

M

98-102 cm  
96-100 cm  
101-103 cm

REF.06312/58/2

L

106-110 cm  
106-110 cm  
102-104 cm

REF.06312/58/3

XL

112-116 cm  
114-118 cm  
105-107 cm

REF.06312/58/4

## Damen-Hosen

### Pantaloni da donna

#### MOD. 41300901

Bi-elastische Hose, niedrige Taille, 2 Seitentaschen. Enganliegend.  
 » 95% Polyester  
 » 5% Bi-Elastic

*Pantaloni doppio elastico, vita bassa, 2 tasche laterali. Aderenti al corpo.*  
 » 95% poliestere  
 » 5% Bi-Elastic

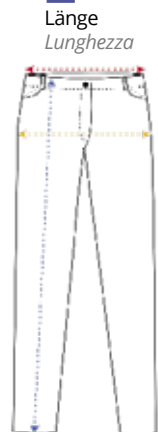

—  
 Tailenumfang  
 Girovita

—  
 Hüftumfang  
 Fianchi

36

74-78 cm  
 90-94 cm  
 100-102 cm

REF. 06311/50/1

38

78-82 cm  
 94-98 cm  
 100-102 cm

REF. 06311/50/2

40

82-86 cm  
 96-100 cm  
 101-103 cm

REF. 06311/50/3

42

88-92 cm  
 98-102 cm  
 103-105 cm

REF. 06311/50/4

44

92-96 cm  
 100-104 cm  
 105-107 cm

REF. 06311/50/5

## Unisex-Hosen

### Pantaloni unisex

#### MOD. 41300904

Hose aus 100% Polyester fein mit 3 Taschen. In der Taille mit einem Kordelzug verstellbar. Leicht zu bügeln. Verbleichschutz und antistatisch.

*Pantaloni 100% poliestere fine con 3 tasche. Vita regolabile con laccio. Facile da stirare. Antistatico e non scolora.*



—  
 Länge  
 Lunghezza

—  
 Tailenumfang  
 Girovita

—  
 Hüftumfang  
 Fianchi

S

92-96 cm  
 92-96 cm  
 99-101 cm

REF. 06356/1

M

98-102 cm  
 96-100 cm  
 101-103 cm

REF. 06356/2

L

106-110 cm  
 106-110 cm  
 102-104 cm

REF. 06356/3

XL

112-116 cm  
 114-118 cm  
 105-107 cm

REF. 06356/4

# Haarkosmetik

COSMETICI  
PER CAPELLI

*Shampoos, masken, färbemittel,  
Bleichmittel, oxidationsmittel...*

*Shampoo, balsamo, tinta per capelli,  
Decoloranti, creme ossidanti...*

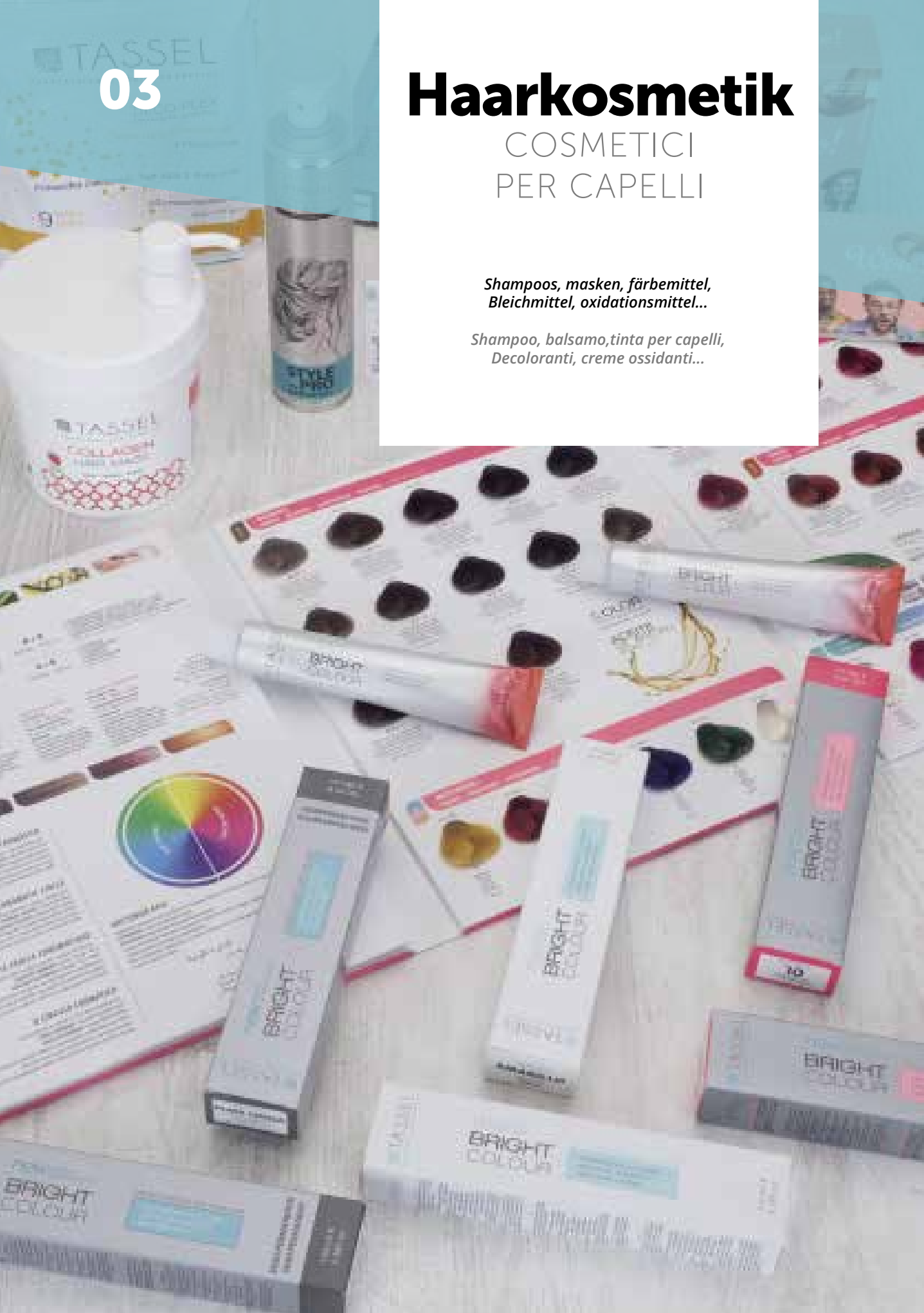

## Bright Colour Farbstoffe von Tassel

### Colore Bright Colour di Tassel



Oxidations-Cremefärbemittel, angereichert mit Arganöl, Keratin und pflanzlichen Wachsen, die die Farbe fixieren und gleichzeitig dem Haar Glanz und Schutz verleihen. Weich strukturierte Creme. Aufgrund ihrer Zusammensetzung behandelt es das Haar, pflegt es, schützt es und bildet eine Schutzbarriere, um die Haarstruktur nicht zu schädigen. Farbbeständigkeit und maximale Abdeckung. Große Auswahl an Farben, die die Marktbedürfnisse abdecken.

*Colore in crema arricchito con olio di argan, cheratina e cere vegetali che aiutano a fissare il colore fornendo lucentezza e protezione ai capelli. Crema dalla texture delicata. Grazie alla sua composizione, si prende cura dei capelli proteggendoli e formando una barriera protettiva per non danneggiare la struttura capillare. Colore duraturo e massima copertura. Ampia gamma di colori che soddisfano le esigenze del mercato.*



**100%ige Abdeckung und Haltbarkeit Verleiht  
Glanz und Schutz  
95 intensive Farben**

**Copertura e durata al 100%  
Dona lucentezza e protezione  
95 colori intensi**

- » Hergestellt aus Arganöl, Keratin und pflanzlichen Wachsen, die zur Fixierung der Farbe beitragen, dem Haar sowohl Glanz als auch Schutz verleihen
- » Sortierte Farben mindestens 3 Einheiten pro
- » Farbe von 36 Einheiten

- » *Composizione a base di olio di argan, cheratina e cere vegetali che aiutano a fissare il colore, donando lucentezza e protezione ai capelli*
- » *Colori assortiti. Minimo 3 unità per colore*
- » *Scatole complete: 36 unità*

**Keratin  
Pflanzenwaxse  
Arganöl**

**Cheratina Cere  
Vegetali  
Olio di Argan**

11.5

New

## nordic BRIGHT COLOUR

Ref. 0646E

**10N** ▼

RUBIO SUPER CLARO  
SUPER LIGHT BLONDE  
BLOND SUPER CLAIR  
LEHTINEN OIKARILUONNIN  
LOURO SUPER CLARO  
الشعر فاتح جداً

Ref. 0646D

**10.3N** ▼

RUBIO SUPER CLARO DORADO  
SUPER LIGHT GOLDEN BLONDE  
BLOND SUPER CLAIR DORÉ  
LOURO SUPER CLARO DOURADO  
СЫРЬ-СЫРЬЯМ ПЛЕТЕНЬКО-ЗОЛОТОСЫМ БЛОНД  
الشعر ذهبي فاتح جداً

Ref. 0646F

**10.31N** ▼

RUBIO SUPER CLARO DORADO CINZA  
SUPER LIGHT GOLDEN ASH BLONDE  
BLOND SUPER CLAIR DORÉ CENDRE  
LOURO SUPER CLARO DOURADO CINZA  
СЫРЬ-СЫРЬЯМ ПЛЕТЕНЬКО-ЗОЛОТОСЫМ СЕРА  
الشعر ذهبي فاتح جداً

Ref. 0646H

**10.32N** ▼

RUBIO SUPER CLARO BEIGE  
SUPER LIGHT BEIGE BLONDE  
BLOND SUPER CLAIR BEIGE  
LOURO SUPER CLARO BEGE  
СЫРЬ-СЫРЬЯМ БЕЖЕ ИЛИ БЛОНД  
الشعر بيج فاتح جداً

Ref. 0646G

**9.13N** ▼

RUBIO MUY CLARO CINZA  
VERY LIGHT GOLDEN ASH BLONDE  
BLOND TRÈS CLAIR CENDRE DORÉ  
LOURO MUITO CLARO CINZA DOURADO  
СЫРЬ-СЫРЬЯМ ЗОЛОТОСЫМ СЕРА  
الشعر ذهبي فاتح جداً

Ref. 0646I

**9.21N** ▼

RUBIO MUY CLARO BEIGE CINZA  
VERY LIGHT BEIGE ASH BLONDE  
BLOND TRÈS CLAIR BEIGE CENDRE  
LOURO MUITO CLARO BEGE CINZA  
СЫРЬ-СЫРЬЯМ БЕЖЕ ИЛИ СЕРА  
الشعر رمادي فاتح جداً

Ref. 0646J

**9.23N** ▼

RUBIO MUY CLARO BEIGE DORADO  
VERY LIGHT GOLDEN BEIGE BLONDE  
BLOND TRÈS CLAIR BEIGE DORÉ  
LOURO MUITO CLARO BEGE DOURADO  
СЫРЬ-СЫРЬЯМ ЗОЛОТОСЫМ БЕЖЕ ИЛИ СЕРА  
الشعر ذهبي فاتح جداً

Ref. 0646K

**8.21N** ▼

RUBIO CLARO BEIGE CINZA  
LIGHT BEIGE ASH BLONDE  
BLOND CLAIR BEIGE CENDRE  
LOURO CLARO BEGE CINZA  
СЫРЬЯМ ПЛЕТЕНЬКО-БЕЖЕ ИЛИ СЕРА  
الشعر رمادي فاتح جداً

Ref. 0646L

**8.23N** ▼

RUBIO CLARO BEIGE DORADO  
LIGHT GOLDEN BEIGE BLONDE  
BLOND CLAIR BEIGE DORÉ  
LOURO CLARO BEGE DOURADO  
СЫРЬЯМ ЗОЛОТОСЫМ БЕЖЕ ИЛИ СЕРА  
الشعر ذهبي فاتح جداً

11.3

## SUPER ACLARANTES

SUPER LIGHTENERS · SUPER ÉCLAIRCISANTS · СИЛЬНЫЕ ОСВЕТЛИТЕЛИ · SUPERACLARADORES · ألوان فاتحة مختلفة

Ref. 0394E

**11.21** ▼

RUBIO EXTRA CLARO PERLA CINZA  
PEARL ASH EXTRA LIGHT BLONDE  
BLOND EXTRA CLAIR PERLE CENDRE  
ПЕРЛЕНОВАЯ СПИЧКА ИЛИ С  
ПЕЛОВИЧНО-БЕЛЫХ ПЕРЛЫХ ОТТЕНКОВ  
LOURO EXTRA CLARO PEROLA CINZA  
الشعر فاتح جداً لؤلؤي رمادي

Ref. 0395

**11.00** ▼

RUBIO EXTRA CLARO NATURAL  
NATURAL EXTRA LIGHT BLONDE  
BLOND EXTRA CLAIR NATUREL  
ПЛАТЯНОВАЯ СПИЧКА ИЛИ С  
НАТУРАЛЬНЫМИ ОТТЕНКАМИ  
LOURO NATURAL EXTRA CLARO  
الشعر فاتح جداً طبيعي

Ref. 0495

**12** ▼

SUPERACLARANTE  
RUBIO NATURAL  
BLOND NATURAL SUPERLIGHTENING  
BLOND NATUEL SUPER ÉCLAIRCISANT  
СЫРЬЯМ ПЛЕТЕНЬКО ИЛИ СЕРА  
LOURO SUPER ACLARADOR NATURAL  
الشعر طبيعي بيج فاتح جداً

Ref. 0496

**12.1** ▼

SUPERACLARANTE RUBIO CINZA  
SUPERLIGHTENING ASH BLONDE  
BLOND CENDRE SUPER ÉCLAIRCISANT  
СЫРЬ-СЫРЬЯМ ПЛЕТЕНЬКО ИЛИ СЕРА  
LOURO SUPER ACLARADOR CINZA  
الشعر رمادي بيج فاتح جداً

Ref. 0497

**12.96** ▼

RUBIO SUPERACLARANTE CINZA VIOLETA  
SUPERLIGHTENING VIOLET ASH BLONDE  
BLOND VIOLET CENDRE SUPER  
ÉCLAIRCISANT  
СЫРЬ-СЫРЬЯМ ПЛЕТЕНЬКО ИЛИ СЕРА  
СЫРЬЯМ ПЛЕТЕНЬКО ИЛИ СЕРА  
LOURO SUPER ACLARADOR PLATINO VIOLETA  
الشعر رمادي بيج فاتح جداً

Ref. 0820

**PLATA** ▼

PLATA SUPERACLARANTE  
SUPER LIGHTENING SEVERE  
ARGENT SUPER ÉCLAIRCISANT  
СЫРЬЯМ ПЛЕТЕНЬКО ИЛИ СЕРА  
PLATA SUPER ACLARADOR  
الشعر فاتح جداً

11.4

## TONOS PASTEL · PASTEL TONES · TONS PASTEL · ПАСТЕЛЬНЫЕ ОТТЕНКИ · ألوان ناعمة

Ref. 0714D

**PT 0.8** ▼

ROSA PASTEL  
PINK PASTEL  
ROSE PASTEL  
РОЗОВЫЙ  
ناعم لؤلؤي

Ref. 0715D

**PT 0.7** ▼

LILA PASTEL  
LILAC PASTEL  
VIOLET PASTEL  
ЛИЛА  
ناعم لؤلؤي

Ref. 0716D

**PT 0.4** ▼

MELCOTON  
PEACH+ROSE  
PEACH  
РОЗОВО-ПЕЧЕНЬКОВЫЙ  
ناعم لؤلؤي

Ref. 0717D

**PT 0.1** ▼

GRIS METÁLICO  
METALIC GREY  
GRIS METÁLICO  
СЫРЬЯМ МЕТАЛЛИК  
ناعم لؤلؤي

## BASES NATURALES

NATURAL BASE COLOURS · BASES NATURELLES · НАТУРАЛЬНЫЕ БАЗОВЫЕ · BASES NATURAIS · اَسْسِن طَبِيعِيَّة

1+1.5

Ref. 03954



10 ▼

RUBIO SUPER CLARO  
SUPER LIGHT BLONDE  
BLOND SUPER CLAIR  
PLATYNORM BLEICHUNG  
LOURO SUPER CLARO  
اشقر فاتح فاتح

Ref. 03955



9 ▼

RUBIO MUY CLARO  
VERY LIGHT BLONDE  
BLOND TRÈS CLAIR  
SPHÈRE CÉSTIM BLEICHUNG  
LOURO MUITO CLARO  
اشقر فاتح جدا

Ref. 03956



8 ▼

RUBIO CLARO  
LIGHT BLONDE  
BLOND MOYEN  
SPHÈRE BLEICHUNG  
LOURO CLARO  
اشقر فاتح

Ref. 03957



7 ▼

RUBIO MEDIO  
MEDIUM BLONDE  
BLOND FONCE  
SPHÈRE BLEICHUNG  
LOURO MEDIO  
اشقر متوسط

Ref. 03958



6 ▼

RUBIO OSCURO  
DARK BLONDE  
BLOND FONCE  
TEMMER BLEICHUNG  
LOURO ESCURO  
اشقر داكن

Ref. 03959



5 ▼

CASTAÑO CLARO  
LIGHT CHESTNUT  
CHÂTAIGN CLAIR  
СЫСТАЙ КАСТАН  
CASTAÑO CLARO  
كستنائي فاتح

Ref. 03960



4 ▼

CASTAÑO MEDIO  
MEDIUM CHESTNUT  
CHÂTAIGN MOYEN  
СЫСТАЙ КАСТАН  
CASTAÑO MEDIO  
كستنائي متوسط

Ref. 03961



3 ▼

CASTAÑO OSCURO  
DARK CHESTNUT  
CHÂTAIGN FONCE  
ТЕМНЫЙ КАСТАН  
CASTAÑO OSCURO  
كستنائي داكن

Ref. 03962



2 ▼

MORE OR  
LESS  
BROWN  
КОРНА-МЕН  
MORE OR  
LESS  
أشقر

Ref. 03963



1 ▼

NEGRO  
BLACK  
NOIR  
ЧЕРНЫЙ  
PRETO  
أسود

## BASES FRIAS

COOL BASE COLOURS · BASES FROIDES · ХОЛОДНЫЕ БАЗОВЫЕ · BASES FRIAS · اَسْسِن بَارِدَة

1+1.5

Ref. 03964



9.01 ▼

RUBIO MUY CLARO FRO  
COOL VERY LIGHT BLONDE  
BLOND TRÈS CLAIR FROID  
SPHÈRE BLEICHUNG BLAUHAAR  
LOURO MUITO CLARO FRO  
اشقر فاتح جدا بارد

Ref. 03965



8.01 ▼

RUBIO CLARO FRO  
COOL LIGHT BLONDE  
BLOND CLAIR FROID  
SPHÈRE BLEICHUNG BLAUHAAR  
LOURO CLARO FRO  
اشقر فاتح بارد

Ref. 03966



7.01 ▼

RUBIO MEDIO FRO  
COOL MEDIUM BLONDE  
BLOND MOYEN FROID  
SPHÈRE BLEICHUNG BLAUHAAR  
LOURO CLARO FRO  
اشقر متوسط بارد

Ref. 03967



6.01 ▼

RUBIO OSCURO FRO  
COOL DARK BLONDE  
BLOND FONCE FROID  
SPHÈRE BLEICHUNG BLAUHAAR  
LOURO OSCURO FRO  
اشقر داكن بارد

## VIOLETES

VIOLETS · ФИОЛЕТОВЫЕ · VIOLETAS · اَلرَّانِ بِنَفْسِيَّة

1+1.5

Ref. 03985



7.88 ▼

FUSCIA ARDENTE  
FENY FUSCIA  
ROUGE ARDENT  
СЫСТАЙ РОЗОВУВАЯ  
ROUX ARDENTE  
أز حدالي حاد

Ref. 03987



4.20 ▼

CASTAÑO MEDIO VIOLETA  
MEDIUM VIOLET CHESTNUT  
CHÂTAIGN MOYEN VIOLET  
СЫСТАЙ КАСТАН С  
ФИОЛЕТОВЫМ ОТТЕНКОМ  
CASTAÑO MEDIO VIOLETA  
كستنائي متوسط بنفسي

Ref. 03989



1.20 ▼

NEGRO MORA  
VIOLET BLACK  
NOIR VIOLET  
ЧЕРНАЯ ФИОЛЕТОВАЯ  
PRETO VIOLETA  
أسود بنفسجي

1+1.5

## CAOBAS · DARK AUBURN · ACAJOU

МАХАГОНОВЫЕ · ACAJOU · ماهو غامبي

Ref. 03987



6.54 ▼

RUBIO OSCURO CAOBA COBRADO  
DARK AUBURN DARK BROWN  
BLOND FONCE ACAJOU CUNVE  
TEMMER BLEICHUNG C  
MEDIO MAHAGONOVYIM OTTENOKOM  
LOURO ESCURO ACAJOU ACORRIDADO  
اشقر داكن ماهو غامبي نجاسي

Ref. 03989



5.5 ▼

CASTAÑO CLARO CADEX  
LIGHT AUBURN  
CHÂTAIGN CLAIR ACAJOU  
СЫСТАЙ КАСТАН С  
МАХАГОНОВЫМ ОТТЕНКОМ  
CASTAÑO CLARO ACAJOU  
كستنائي فاتح ماهو غامبي

DORADOS  
GOLDEN · DONÉS · ЗОЛОТЫЕ · DOURADOS · ذهنية

Ref. 03972



8.34 ▼

RUBIO CLARO DOURADO COBRE  
GOLDEN COPPER LIGHT BLONDE  
BLOND CLAIR DORÉ CUIVRE  
СРЕДНЯЯ ЗОЛОТЫЙ С КОПРЬЮ  
ЗОЛОТЫЙ СРЕДНЯЯ КОПРЬ  
LOURO CLARO DOURADO ACOBREADO  
ألقر فاتح ذهني نحاسي

Ref. 03977



5.3 ▼

CASTAÑO CLARO DOURADO  
LIGHT GOLDEN CHESTNUT  
CHÂTAÎN CLAIR DORÉ  
СРЕДНЯЯ ЗОЛОТЫЙ С ЗОЛОТЫМ  
ОТТЕКОМ  
CASTAÑO CLARO DOURADO  
كستنائي فاتح ذهني

Ref. 03973



9.3 ▼

RUBIO MUY CLARO DOURADO  
VERY LIGHT GOLDEN BLONDE  
BLOND TRÈS CLAIR DORÉ  
СРЕДНЯЯ ЗОЛОТЫЙ С  
ЗОЛОТЫМ ОТТЕКОМ  
LOURO MUITO CLARO DOURADO  
ألقر فاتح جدا ذهني

Ref. 04003



5.35 ▼

CASTAÑO CLARO DOURADO CACA  
MEDIUM GOLDEN HAWKOGAMY CHESTNUT  
CHÂTAÎN CLAIR DORÉ ACAJOU  
СРЕДНЯЯ ЗОЛОТЫЙ С КОКОСОВЫМ  
КАЛЫНОВЫМ  
CASTAÑO CLARO DOURADO ACAJÚ  
كستنائي فاتح احمر الناج

Ref. 03974



8.3 ▼

RUBIO CLARO DOURADO  
GOLDEN LIGHT BLONDE  
BLOND CLAIR DORÉ  
СРЕДНЯЯ ЗОЛОТЫЙ С  
СРЕДНЯЯ ТОН ОТТЕКОМ  
LOURO CLARO DOURADO  
ألقر فاتح ذهني

Ref. 04009



7.31 ▼

RUBIO MEDIO DOURADO FRO  
COOL MEDIUM GOLDEN BLONDE  
BLOND MOYEN DORÉ FROID  
СРЕДНЯЯ ЗОЛОТЫЙ С ЗОЛОТЫМ  
ТЕПЛОМ  
LOURO MEDIO DOURADO FRO  
ألقر متوسط احمر بارد

Ref. 03975



7.3 ▼

RUBIO MEDIO DOURADO  
MEDIUM GOLDEN BLONDE  
BLOND MOYEN DORÉ  
СРЕДНЯЯ ЗОЛОТЫЙ С ЗОЛОТЫМ  
ОТТЕКОМ  
LOURO MEDIO DOURADO  
ألقر متوسط ذهني

Ref. 04130



8.31 ▼

RUBIO CLARO DOURADO CINZA  
LIGHT GOLDEN ASH BLONDE  
BLOND CLAIR DORÉ CENDRE  
СРЕДНЯЯ ЗОЛОТЫЙ С  
СРЕДНЯЯ ЗОЛОТЫЙ СРЕДНЯЯ  
LOURO CLARO DOURADO CINZA  
ألقر فاتح مذهب رمادي

Ref. 03976



6.3 ▼

RUBIO CLARO DOURADO  
DARK GOLDEN BLONDE  
BLOND CLAIR DORÉ  
СРЕДНЯЯ ЗОЛОТЫЙ С ЗОЛОТЫМ  
ОТТЕКОМ  
LOURO CLARO DOURADO  
ألقر فاتح ذهني

Ref. 04004



7.35 ▼

RUBIO MEDIO DOURADO CACA  
MEDIUM GOLDEN HAWKOGAMY BLONDE  
BLOND MOYEN DORÉ ACAJOU  
СРЕДНЯЯ ЗОЛОТЫЙ С ЗОЛОТЫМ  
ОТТЕКОМ  
LOURO MEDIO DOURADO ACAJÚ  
ألقر متوسط احمر الناج

CENIZAS  
ASH · CENDRES · ПЕПЕЛЬНЫЕ · CINZAS · رمادية

Ref. 03958



8.1 ▼

RUBIO CLARO CINZA  
LIGHT ASH BLONDE  
BLOND CLAIR CENDRE  
СРЕДНЯЯ ЗОЛОТЫЙ С  
СРЕДНЯЯ ОТТЕКОМ  
LOURO CLARO CINZA  
ألقر فاتح رمادي

Ref. 03959



7.1 ▼

RUBIO MEDIO CINZA  
MEDIUM ASH BLONDE  
BLOND MOYEN CENDRE  
СРЕДНЯЯ ЗОЛОТЫЙ С  
СРЕДНЯЯ ОТТЕКОМ  
LOURO MEDIO CINZA  
ألقر متوسط رمادي

Ref. 03970



6.1 ▼

RUBIO OSCURO CINZA  
DARK ASH BLONDE  
BLOND FONCÉ CENDRE  
СРЕДНЯЯ ЗОЛОТЫЙ С  
СРЕДНЯЯ ОТТЕКОМ  
LOURO OSCURO CINZA  
ألقر داكن رمادي

Ref. 03971



5.1 ▼

CASTAÑO CLARO CINZA  
LIGHT ASH CHESTNUT  
CHÂTAÎN CLAIR CENDRE  
СРЕДНЯЯ ЗОЛОТЫЙ С  
СРЕДНЯЯ ОТТЕКОМ  
CASTAÑO CLARO CINZA  
كستنائي فاتح رمادي

Ref. 04038



1.1 ▼

NEIRO AZULADO  
BLUE BLACK  
NOIR BLEUÉ  
NEIRO AZULADO  
أسود أزلي

Ref. 04033



10.1 ▼

RUBIO PLATINO CINZA  
ASH PLATINUM BLONDE  
BLOND PLATINE CENDRE  
СРЕДНЯЯ ЗОЛОТЫЙ С  
LOURO PLATINO CINZA  
ألقر بياض رمادي

Ref. 04039



PLATA ▼

PLATA INTENSO CINZA CINZA  
ASH INTENSE SILVER  
CENDRE ARGENT INTENSE  
СРЕДНЯЯ ЗОЛОТЫЙ С  
PLATA INTENSO CINZA  
ألقر مركز مائل لرمادي

BEIGE  
БЕЖЕВЫЕ · BEGE · بيج

Ref. 03978



9.32 ▼

RUBIO MUY CLARO BEGE  
VERY LIGHT BEIGE BLONDE  
BLOND TRÈS CLAIR BEIGE  
СРЕДНЯЯ ЗОЛОТЫЙ С  
СРЕДНЯЯ ОТТЕКОМ  
LOURO MUITO CLARO BEGE  
ألقر فاتح جدا بيج

Ref. 03979



8.32 ▼

RUBIO CLARO BEGE  
LIGHT BEIGE BLONDE  
BLOND CLAIR BEIGE  
СРЕДНЯЯ ЗОЛОТЫЙ С  
СРЕДНЯЯ ОТТЕКОМ  
LOURO CLARO BEGE  
ألقر فاتح بيج

Ref. 03980



7.32 ▼

RUBIO MEDIO BEGE  
MEDIUM BEIGE BLONDE  
BLOND MOYEN BEIGE  
СРЕДНЯЯ ЗОЛОТЫЙ С  
СРЕДНЯЯ ОТТЕКОМ  
LOURO MEDIO BEGE  
ألقر متوسط بيج

1+1.5

## MARRONES

BROWN · MARRONS · КОПЧЕНЫЕ · MARRONS · ألوان بنية كلاسيكية

Ref. 0488



8.77 ▼

FIBRO CLARO CHOCOLATE  
LIGHT CHOCOLATE BLONDE  
BLOND CLAIR CHOCOLAT  
BLOND CIEITO KOPCHENYI  
LOURO CLARO CHOCOLATE  
ألوان فاتح شوكولاتي

Ref. 0381



7.77 ▼

FIBRO MEDIO CHOCOLATE  
MEDIUM CHOCOLATE BLONDE  
BLOND MOYEN CHOCOLAT  
CIEIENYI KOPCHENYI  
BLOND MOYEN CHOCOLATE  
ALTO MEDIO CHOCOLATE  
ألوان متوسط شوكولاتي

Ref. 0480



6.77 ▼

FIBRO OSCURO MARRON MEDIO  
MEDIUM BROWN DARK BLONDE  
BLOND FONCE MARRON MOYEN  
TEMNAR SICHYI CIEIENYI  
KOPCHENYI  
FIBRO OSCURO CASTAÑO MEDIO  
ألوان وادم كاستاني متوسط

Ref. 0382



5.77 ▼

MARRON CHOCOLATE  
CHOCOLATE BROWN  
MARRON CHOCOLAT  
KOPCHENYI CIEIENYI KOPCHENYI  
MARRON CHOCOLATE  
بني شوكولاتي

Ref. 0487



4.77 ▼

CASTAÑO MEDIO CHOCOLATE  
MEDIUM CHOCOLATE CHESTNUT  
CHATEAU MOYEN CHOCOLAT  
CIEIENYI KOPCHENYI KOPCHENYI  
CASTAÑO MEDIO CHOCOLATE  
كاستاني متوسط شوكولاتي

Ref. 0481



8.7 ▼

FIBRO CLARO MARRON  
LIGHT BROWN BLONDE  
BLOND CLAIR MARRON  
BLOND CIEITO KOPCHENYI  
LOURO CLARO CASTAÑO  
ألوان بني فاتح

Ref. 0485



7.7 ▼

FIBRO MEDIO MARRON  
MEDIUM BROWN BLONDE  
BLOND MOYEN MARRON  
CIEIENYI KOPCHENYI  
LOURO MEDIO CASTAÑO  
ألوان بني متوسط

Ref. 0483



6.7 ▼

FIBRO OSCURO MARRON  
DARK BROWN BLONDE  
BLOND FONCE MARRON  
BLOND TEMNAR KOPCHENYI  
LOURO OSCURO CASTAÑO  
ألوان بني غامق

Ref. 0482



5.7 ▼

CASTAÑO CLARO MARRON  
LIGHT BROWN CHESTNUT  
CHATEAU CLAIR MARRON  
CIEITO BLOND  
CASTAÑO CLARO CASTAÑO  
كاستاني فاتح بني

Ref. 0486



7.71 ▼

FIBRO MEDIO MARRON FRO  
COOL MEDIUM BROWN BLONDE  
BLOND MOYEN MARRON FRO  
BLOND MOYEN KOPCHENYI  
LOURO MEDIO CASTAÑO FRO  
ألوان بني الفاتح

Ref. 0484



6.71 ▼

FIBRO OSCURO MARRON FRO  
COOL DARK BROWN BLONDE  
BLOND FONCE MARRON FRO  
TEMNAR SICHYI KOPCHENYI  
LOURO OSCURO CASTAÑO FRO  
ألوان بني الغامق

Ref. 0383



7.73 ▼

FIBRO MEDIO AVELLANA  
MEDIUM HAZELNUT BLONDE  
BLOND MOYEN NOISETTE  
CIEIENYI KOPCHENYI CIEIENYI  
OTTEHMERN  
LOURO MEDIO AVELA  
ألوان متوسط بندق

Ref. 0384



6.73 ▼

MARRON AVELLANA  
HAZELNUT BROWN  
MARRON NOISETTE  
KOPCHENYI CIEIENYI  
OTTEHMERN  
MARRON AVELA  
بني بندقCOLOR  
PROFESIONAL  
PROFESSIONAL COLOURACEITE  
DE ARGÁN  
ARGAN OIL

1+1.5

## MATIZADORES

TONERS · NUANCEURS · OTTEHMERN · مكثبات

Ref. 0648

AMARELO  
YELLOW  
JAUNE  
KOPCHENYI  
AMARELO  
الأصفر

Ref. 0642

ROJO  
RED  
ROUGE  
KOPCHENYI  
VERMELHO  
الأحمر

Ref. 0645

VIOLETA  
VIOLET  
VIOLET  
KOPCHENYI  
VIOLETA  
البنفسجي

Ref. 0643

AZUL  
BLUE  
BLEU  
COPCHA  
AZUL  
أزرق

Ref. 0646





VERDE  
GREEN  
VERT  
KOPCHENYI  
VERDE  
الأخضر

Ref. 0641

00 ▼  
BASE BLANCA BEZCLA  
WHITE MIXTURE BASE  
BASE MELANGE BLANCHE  
BEZAR BEZCLA  
BIANCA  
الأساس الأبيض



**ROJOS**  
RÉDS · ROUGES · КРАСНЫЕ · VERMELHOS · أحمر





<p>Ref. 0334</p>  <p><b>5.6</b> ▼ CASTAÑO CLARO ROJO LIGHT RED CHESTNUT CHÂTAIN CLAIR ROUGE CASTAÑO CLARO ROJO CASTAÑO CLARO VERMELHO كشاكشاشي فاتح أحمر</p>	<p>Ref. 0341</p>  <p><b>6.6</b> ▼ RUBIO OSCURO ROJO DARK RED BLONDE BLOND FONCÉ ROUGE TEMNY KOPANÝ RYŠAVÝ LOURO ESCURO VERMELHO أشقر داكن أحمر</p>	<p>Ref. 0380</p>  <p><b>6.64</b> ▼ RUBIO OSCURO ROJO COBRE DARK COPPER RED BLONDE BLOND FONCÉ ROUGE CUIVRE TEMNY KOPANÝ RYŠAVÝ S TĚMNO KOPANÝM OTTĚMOM LOURO ESCURO VERMELHO ACORADO أشقر داكن أحمر نحاسي</p>	<p>Ref. 0386</p>  <p><b>7.63</b> ▼ RUBIA CHERRY RED CERISE NYŠTERBY VERMELHO CEREA قرزى</p>	<p>Ref. 06470</p>  <p><b>7.62</b> ▼ RUBIO MEDIO ROJO CEREZA MEDIUM CHERRY BLONDE BLOND MOYEN CERISE LOURO MEDIO CEREJA CEREA أشقر متوسط قرزى</p>
---	---	--	---	---

Ref. 0660



**8.66** ▼  
RUBIO CLARO ROJO FUEGO  
LIGHT FIERY BLONDE  
BLOND CLAIR FEU  
CEREBAR DEZHGO-KOPANÝ RYŠAVÝ  
LOURO VERMELHO CLARO FOGO  
أشقر ناري فاتح

**COBRES**  
COPPERS · CUIVRES · МЕДНЫЕ · ACORADOS · نحاسية

<p>Ref. 0709</p>  <p><b>8.44</b> ▼ RUBIO CLARO COBRE INTENSO INTENSE COPPER LIGHT BLONDE BLOND CLAIR CUIVRE INTENSE INTENSIVNO MEDNIY CRYTBAR SOKLA LOURO CLARO ACORADO INTENSO أشقر صاف نحاسي داكن</p>	<p>Ref. 0109</p>  <p><b>7.44</b> ▼ RUBIO MEDIO COBRE INTENSO INTENSE MEDIUM COPPER BLONDE BLOND MOYEN CUIVRE INTENSE DREZHNY RYŠAVÝ S C. RYŠAVÝM OTTĚMOM LOURO MEDIO ACORADO INTENSO أشقر متوسط نحاسي قوي</p>	<p>Ref. 0398</p>  <p><b>7.43</b> ▼ RUBIO MEDIO COBRE DORADO MEDIUM GOLDEN COPPER BLONDE BLOND MOYEN CUIVRE DORÉ CEREBAR DEZHGO S ZOROTACHO MEDNIY OTTĚMOM LOURO MEDIO ACORADO DOURADO أشقر متوسط نحاسي ذهبي</p>	<p>Ref. 0391</p>  <p><b>7.4</b> ▼ RUBIO MEDIO COBRE MEDIUM COPPER BLONDE BLOND MOYEN CUIVRE CEREBAR DEZHGO S MEDNIY OTTĚMOM LOURO MEDIO ACORADO أشقر متوسط نحاسي</p>
--	--	---	---



**CERAS VEGETALES**  
VEGETABLE WAXES



<p>Ref. 0392</p>  <p><b>6.44</b> ▼ RUBIO OSCURO COBRE INTENSO DARK INTENSE COPPER BLONDE BLOND FONCÉ CUIVRE INTENSE TEMNY KOPANÝ S RYŠAVÝM OTTĚMOM LOURO ESCURO ACORADO INTENSO أشقر داكن نحاسي قوي</p>	<p>Ref. 0393</p>  <p><b>6.4</b> ▼ RUBIO OSCURO COBRE I DARK COPPER BLONDE BLOND FONCÉ CUIVRE TEMNY KOPANÝ S MEDNIY OTTĚMOM LOURO ESCURO ACORADO أشقر داكن نحاسي</p>
---	--

**FANTASÍA**  
FANTASY · FANTAISIE · ФАНТАЗИЯ · FANTASIA · فانتازيا

· APLICACIÓN DIRECTA SIN EMULSION · DIRECT APPLICATION WITHOUT EMULSION  
· APLICAZIONE DIRETTA SEN EMULSION · APLICAZIONE DIRETTA SEN EMULSION  
· APLICAZIONE DIRETTA SEN EMULSION · APLICAZIONE DIRETTA SEN EMULSION

<p>Ref. 0402</p>  <p><b>B.0</b> ▼ BLANCO WHITE BLANC BIANCO BIANCO أبيض</p>	<p>Ref. 0403</p>  <p><b>B.8</b> ▼ ROSA PINK ROSE POSKA ROSA وردي</p>	<p>Ref. 0404</p>  <p><b>B.5</b> ▼ CICLAMEN CYCLAMEN CYCLAMEN CICLAMEN CICLAMEN باجور قزويني</p>	<p>Ref. 0405</p>  <p><b>B.7</b> ▼ GRAP GRAPE BAGN BIRHOFAE UVA عنب</p>	<p>Ref. 0406</p>  <p><b>B.6</b> ▼ AZUL BLUE BLEU CAHALO AZUL أزرق</p>	<p>Ref. 0407</p>  <p><b>B.3</b> ▼ AMARILLO YELLOW JAUNE GELTR AMARILLO أصفر</p>
--	---	--	---	---	--

**Farbkarte mit Strähnen**  
*Catalogo colori, tinte per capelli, a ciocche*1  
u.m.vta20  
box

REF.04581/4

**Farbkarte mit gedruckten Farben**  
*Catalogo colori, delle tinte per capelli*1  
u.m.vta25  
box

REF.EM49325



### Oxidationscreme 20 vol. Crema ossidante 20 vol.

Schnelle und bequeme Trockenreinigung  
*Lavaggio a secco veloce e comodo*

NEW



75 ml

20 vol

REF. 07160



### Oxidierende Creme Crema ossidante



Dank ihrer cremigen Textur und ihrer Bestandteile aus Pflanzenextrakten und natürlichen Ölen lässt es sich leichter emulgieren und auf dem Haar verteilen, wobei es die Haarfaser viel besser schützt und das Haar weich und gepflegt bleibt.

*Grazie alla sua cremosità e ai suoi componenti a base di estratti vegetali e oli naturali, è più facile da miscelare e applicare sui capelli, nel pieno rispetto del cuoio capelluto e delle fibre del capello, lasciando i capelli morbidi e trattati.*

» Apfel-Parfüm  
» Profumo di mela

150 ml

10 vol

REF. 04336

20 vol

REF. 04209

30 vol

REF. 04210

40 vol

REF. 04211



» Apfel-Parfüm  
» Profumo di mela



1L



10 vol

REF. 04337

20 vol

REF. 04067

30 vol

REF. 04068

40 vol

REF. 04069

## Oxidierende Creme Crema ossidante

» Apfel-Parfüm  
» Profumo di mela

1  
u.m.vta

2  
box

5L

10 vol

REF.04438

20 vol

REF.04439

30 vol

REF.04440

40 vol

REF.04441



## Oxidationsmittel Creme Antigelbstich Crema ossidante BLUE

1  
u.m.vta

6  
box

1L

Die innovative Formel von OXY BRIGHT BLUE mit ihrer leichten und fließenden Textur eignet sich besonders für blonde Flecken (ab Höhe 8) und Verfärbungen. Es eliminiert den Gelb- und Orange-Effekt und erhält gleichzeitig die natürliche Farbe ohne unerwünschte Reflexionen.

*L'innovativa formula di OXY BRIGHT BLUE leggera e fluida, è particolarmente indicata per tinte bionde (a partire da altezza 8) e decolorazioni. Elimina l'effetto giallo e arancio mantenendo il colore naturale senza riflessi indesiderati.*



10 vol

REF. 07153

20 vol

REF. 06632

30 vol

REF. 06633

40 vol

REF. 06634

**Färbekasten mit 6 Fantasiefarben**  
**Confezioni di Tinta per capelli da 6 colori fantasia**1  
u.m.vta 1  
box

Färbekasten mit 6 Fantasiefarben. Direkt auf das Haar auftragen. Entdecken Sie alle Kombinationen, die Sie machen können, indem Sie einfach eine unserer Farben mit Weiß mischen und so eine breite Palette von Pastelltönen erhalten. Sie können sie auch miteinander kombinieren. Um einen Hauch von Fantasie hinzuzufügen, können Sie sie auch mit Bright Colour mischen.

*Confezione da 6 colori fantasia. Si applicano direttamente sui capelli. Scopri tutte le combinazioni che puoi realizzare semplicemente mescolando uno qualsiasi dei nostri colori con il bianco, ottenendo così una vasta gamma di tonalità pastello. Inoltre, puoi combinarli tra loro. Per aggiungere un tocco di fantasia, puoi anche mescolarli con le tinture Bright Color.*

- » Weich und feuchtigkeitsspendend.
- » Delicato e idratante.

100 gr

REF.04611



**Kein Oxidationsmittel erforderlich**  
**Non ha bisogno di ossidante**

1  
u.m.vta 6  
boxB-0 ○  
REF. 04442B-3 ●  
REF. 04447B-5 ●  
REF. 04444B-6 ●  
REF. 04446B-7 ●  
REF. 04445B-8 ●  
REF. 04443

\*Nur zum Mischen und verdünnen geeignet · \* Adatto solo per miscele e soluzioni

## Farbstoffschutzöl

### Olio protettivo per tintura



$\alpha$ -Bisabolol vermindert das Risiko einer Hautsensibilisierung und Reizbarkeit und schützt zusammen mit den Vitaminen E, C und Sojalecithin die Haut vor Oxidation. Es bildet eine Schutzbarriere, damit der Farbstoff die Haut nicht befleckt.

*L' $\alpha$ -bisabololo riduce il rischio di sensibilizzazione e irritabilità della pelle e insieme alle vitamine E, C e alla lecitina di soia protegge la pelle dall'ossidazione. Crea una barriera protettiva in modo che il colorante non macchi la pelle.*

120  
u.m.vta

120  
box

3 ml

REF.03929

100  
u.m.vta

1  
u.m.vta

6  
box

150 ml

REF.06282



## Pack farbschutz

### Kit colore

- » Päckchen mit Fleckenschutzöl
- » + Einweg-Schutzhülle
- » + Handschuhe

- » Bustina d'olio protettivo
- » + mantellina monouso
- » + guanti

100  
u.m.vta

100  
box

3 ml

REF.03998



+



+



## WILD BRIGHT Bleichpulver

### Polvere Decolorante WILD BRIGHT



Grossartiger Farbzug und gleichzeitig sanft zu dem Haar. In zwei praktischen Formaten, klein und groß, wählen Sie das Format, das Ihren Bedürfnissen am besten entspricht.

Grande capacità di rimozione del colore pur essendo delicato sui capelli. In due pratici formati, piccolo e grande, scegli quello più adatto alle tue esigenze.



50

u.m.vta



50

box

25 gr

REF. 04289

» Wieder verschließbar  
» Con chiusura salva-prodotto



1

u.m.vta



12

box

500 gr

REF.03922



## WILD WHITE Bleichpulver

### Polvere Decolorante WILD WHITE

#### Arganöl und Keratin

Wild White hat die gleiche Aufhellungskraft wie Wild Bright Bleichmittel, der einzige Unterschied besteht darin, dass es KEIN Ammoniak enthält und die Haarfasern dank Arganöl und Keratin schützt. Es kann auch bei Körper- und Gesichtsverfärbungen mit 10 Vol. Oxidationsmittel verwendet werden.

#### Olio di argan e cheratina

Wild White ha lo stesso potere schiarente del decolorante Wild Bright, l'unica differenza è che NON contiene ammoniaca e protegge la fibra capillare grazie all'olio di argan e alla cheratina. Può essere utilizzato anche per decolorazioni del corpo e del viso utilizzando 10 vol di ossidante.

## Ammoniakfrei

### Senza ammoniaca



50

u.m.vta



50

box

25 gr

REF.03611

» Wieder verschließbar  
» Con chiusura salva-prodotto



1

u.m.vta



12

box

500 gr

REF.03921



## Beutel 500g. Entfärbung deco-plex Confezione da 500g. Decolorazione deco-plex

Mehr Schutz bei Ihren Entfärbungen mit dem neuen DECO-PLEX, mit Rotalgen und Aminosäuren, die die Struktur des Haars pflegen. Kann bis zu 8-9 Töne ausspülen.

*Più protezione durante le tue decolorazioni con il nuovo DECO-PLEX, con Alghe Rosse e Aminoacidi che si prendono cura della struttura del capello. Può schiarire fino a 8-9 livelli.*

**NEW**



25 gr

REF. 07428

» Wieder verschließbar  
» Con chiusura salva-prodotto

**NEW**



500 gr

REF.07201



## Decocrema Tassel 500 gr Decocream Tassel 500 gr



Haarbleichcreme mit hoher aufhellender Wirkung. Seine innovative cremige Textur sorgt für eine bessere Pflege von Haut und Haar. Angereichert mit einem speziellen Polymer, das das Haar schützt und seinen Bruch minimiert. Es enthält Jojobaöl, das zur Verbesserung der Pflegeeigenschaften beiträgt, Glanz und Geschmeidigkeit verleiht, maximale Pflege und besseren Schutz des Haares bietet.

*Crema decolorante per capelli ad alto potere schiarante. La sua innovativa texture in crema si prende più cura della pelle e dei capelli. Arricchita con uno speciale polimero che protegge i capelli minimizzandone la rottura. Contiene olio di jojoba che aiuta a migliorare le proprietà del balsamo, donando lucentezza e morbidezza, offrendo la massima cura e una migliore protezione dei capelli.*

» Mit Jojobaöl  
» Con olio di jojoba

500 gr

REF.06561





# IONI · K TREATMENT



**Schritt für  
Schritt mit  
IONI-K**  
*Step by step  
with IONI-K*

Die Haare werden in 4 einfachen Schritten repariert. Ionen- und Keratinbehandlung, das geschädigte Haar in der Tiefe repariert und es viel glänzender und glatter aussehen lässt. Verhindert Frizz.

*Capelli riparati in 4 semplici passi. Trattamento agli ioni e cheratina che ripara in profondità i capelli danneggiati, lasciando un aspetto molto più lucido e levigato. Evita l'effetto crespo.*

## 1

**Shampoo  
zum Vorglätten**  
*Shampoo pre-lisciante*



500 ml

REF.04949

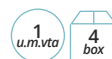

REF.04997

## FORMOL FREI - Keratin-Behandlung

Trattamento alla cheratina FORMOL FREE



Mit einem innovativen Ionensystem zusammengestellt, gibt es dem Haar Kraft und Vitalität zurück, erleichtert das Glätten und beugt Kräuseln vor. Ihr Haar wird gesünder, weicher und glänzender aussehen.

*Formula con innovativo sistema di ioni che ripristina e dona forza e vitalità ai capelli, facilitando l'effetto liscio, e prevenendo l'effetto crespo. I capelli appariranno più sani, morbidi e luminosi.*



2

### Glättung und Anti-Frizz-Behandlung

Trattamento  
capelli lisci e anti effetto  
crespo



500 ml

REF.04951

3

### Shampoo nach der Glättung

Shampoo  
post-lisciante



500 ml

REF.04950

4

### Versiegelnde Haarkur

Balsamo sigillante per  
capelli



400 ml

REF.04982

## Dry shampoo - trockenshampoo in pulverform

### Shampoo secco - shampoo secco in polvere



300 ml

REF.07130



Dry Shampoo ist ein Shampoo in Pulverform, das als Spray aufgetragen wird (BENÖTIGT KEIN WASSER). Es sorgt für ein ausgeprägteres Volumen und trägt dazu bei, dass das Haar länger sauber bleibt. Ideal für fettiges Haar, absorbiert den Überschuss an Talg und schattiert den Haarschaft, wodurch es für ein saubereres und gesünderes Aussehen sorgt. Wird auch für frisch gewaschenes Haar empfohlen, um es zu wellen, ihm Volumen zu geben und das Kämmen zu erleichtern. Für jeden Haartyp.

*Dry Shampoo è uno shampoo in polvere che si applica in spray (NON SERVE SCIAQUARE). Dona un volume più pronunciato. Aiuta i capelli a rimanere puliti più a lungo. Ideale per capelli grassi, assorbe il sebo in eccesso, opacizza la base del capello e dona un aspetto più pulito e sano. È consigliato anche per capelli appena lavati, per apportare texture, aggiungere volume e facilitare lo styling. Per tutti i tipi di capelli.*

## Hyaluronshampoo TASSEL

### Hyaluronic shampoo TASSEL



#### Vorteile

- » Schonende Reinigung
- » Tiefen Hydratation
- » Restrukturiert das Haar

#### Eigenschaften

Angereichert mit Hyaluronsäure. Anti-Aging-Effekt. Sanfte Reinigung und Tiefenbefeuchtung des Haares. Restrukturiert geschädigtes und brüchiges Haar und gibt ihm seine Elastizität zurück. Versorgt das Haar mit Feuchtigkeit und macht es geschmeidig.

#### Benefici

- » Gentle cleaning
- » Pulizia delicata
- » Idratazione profonda
- » Ristruttura i capelli

#### Che cos'è?

Arricchito con acido ialuronico. Effetto anti-età. Pulizia delicata e idratazione profonda dei capelli. Ristruttura i capelli danneggiati e fragili, restituendo loro elasticità. Idrata e ammorbidisce i capelli.



NEW

1 L

REF.07379



## Hyaluronsäure-maske TASSEL

### Hyaluronic mask TASSEL



#### Vorteile

- » Hydratation
- » Glättet
- » Repariert
- » Verhindert Haarbruch

#### Eigenschaften

Angereichert mit Hyaluronsäure. Anti-Aging-Effekt. Versorgt das Haar mit Feuchtigkeit und macht es geschmeidig. Spendet intensive Feuchtigkeit dank der Hyaluronsäure. Repariert und verhindert Bruch und Spliss. Macht das Haar weicher und flexibler.

#### Benefici

- » Idrata
- » Ammorbidisce
- » Ripara
- » reviene la rottura dei capelli

#### Che cos'è?

Arricchito con acido ialuronico. Effetto anti-età. Idrata e ammorbidisce i capelli. Fornisce un'idratazione intensa grazie all'acido ialuronico. Ripara e previene rotture e doppie punte. Ammorbidisce e rende i capelli più flessibili.

NEW

1 L

REF.07380



## Hyaluronic SPLASH

### Hyaluronic SPLASH

Angereichert mit Hyaluronsäure, die dank ihrer Eigenschaften das Haar verbessert und ihm ein Gefühl von tiefer Feuchtigkeit, Füllung und Elastizität verleiht. Frizz vermeidet, ihm Glanz und seidige Textur verleiht. Sie vereinen Arganöl, Seidenproteine und Keratin und bilden ein ausgezeichnetes Anti-Age-Haar.

*Arricchito con Acido ialuronico che, grazie alle sue proprietà, migliora i capelli donandogli una sensazione di profonda idratazione, riempimento ed elasticità, evitando l'effetto crespo, donandogli lucentezza e consistenza setosa. Unendo le proprietà dell'Olio di Argan, delle Proteine della Seta e della Cheratina, formano un ottimo Anti Age per Capelli.*

NEW

1 L

REF.07438



**Shampoo gegen Haarausfall****Shampoo per la prevenzione della caduta dei capelli**

- » Shampoo, das speziell zur Bekämpfung von Haarausfall erstellt wurde, da es Proteine und Bionährstoffe pflanzlichen Ursprungs kombiniert, die als Abschwellungs- und Revitalisierungsmittel wirken und so Reizungen vermeiden
- » Reinigt tief, entfernt die sich auf der Kopfhaut bildenden Öle und lässt das neue Haar sich ungehindert entwickeln
- » Das Haar ist weich, glänzend und seidig

» *Shampoo specificamente formulato per combattere la caduta dei capelli, in quanto combina proteine e bionutrienti di origine vegetale che agiscono come decongestionanti e rivitalizzanti, evitando così le irritazioni.*

- » *Deterge in profondità, eliminando i grassi che si formano sul cuoio capelluto, permettendo ai nuovi capelli di crescere senza impedimenti*
- » *Lascia i capelli morbidi, lucenti e setosi*

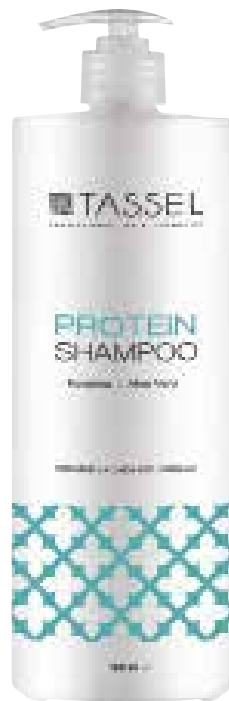

1 u.m.vta 12 box

1 L

REF.03566

1 u.m.vta 6 box

400 ml

REF.03553

**Ampullen gegen Haarausfall****Fiale**

Die besten Nährstoffe für die Kopfhaut sind Proteine pflanzlichen Ursprungs. Sie verbessern die Aufnahme dieser und begünstigen die Sauerstoffanreicherung des Haarfollikels, wodurch der Haarausfall verringert wird. Die pflanzlichen Nährstoffe wirken zudem abschwellend und revitalisierend und vermeiden so Reizungen. Keratin erneuert und stärkt das Haar und verleiht ihm Volumen und Glanz.

*I migliori nutrienti per il cuoio capelluto sono le proteine vegetali. Queste fiale ne aumentano l'assorbimento e favoriscono l'ossigenazione del follicolo pilifero, riducendo così la caduta dei capelli. I nutrienti vegetali agiscono anche come decongestionanti e rivitalizzanti, evitando così le irritazioni. La cheratina ripara e rinforza i capelli, donandogli volume e lucentezza.*

**PACKUNG zur Prävention von Haarausfall**

- » 12 Ampullen (10 ml) zur Prävention von Haarausfall
- » + Präventionsshampoo 400 ml

**PACCHETTO anticaduta**

- » 12 fiale (10 ml) anticaduta
- » + shampoo prevenzione 400 ml

1 u.m.vta 6 box

10 ml

REF.03550

- » 12 Ampullen (10 ml) zur Prävention von Haarausfall

- » 12 fiale (10 ml) anticaduta

1 u.m.vta 50 box

10 ml

REF.03551



### HERBAL Conditioner Creme Balsamo HERBAL

1 u.m.vta  
12 box

Conditioner aus Pflanzenextrakten, die die Haarfaser erneuern, stärken und das Schuppen der Haarfaser verhindern. Diese Extrakte verleihen dem Haar Weichheit, Glanz und Leuchtkraft, was die Frisur begünstigt.

*Balsamo con estratti vegetali che riparano, rinforzano e prevengono la desquamazione della fibra capillare. Questi estratti donano ai capelli morbidezza, lucentezza e luminosità, favorendo l'acconciatura.*



1 L

REF.03555

### NEUTRALES Shampoo Shampoo NEUTRO

1 u.m.vta  
12 box

Shampoo für alle Haartypen und besonders geeignet für die tägliche oder häufige Anwendung. Es wäscht das Haar auf sanfte Weise und erhält den PH-Wert. Schützt die Kopfhaut und verleiht dem Haar Ausgeglichenheit und Gesundheit.

*Shampoo per tutti i tipi di capelli e particolarmente indicato per un uso quotidiano o frequente. Lava i capelli in modo delicato e mantenendo il giusto PH. Protegge il cuoio capelluto, donando equilibrio e salute ai capelli.*



1 L

REF.03556

» Häufige  
Anwendung  
» Uso frequente

### FARBSCHUTZ Shampoo Shampoo PROTECT COLOR

Spezifisches Shampoo für gefärbtes oder coloriertes Haar. Belebt und bewahrt die Haarfarbe länger und sorgt für ein weiches, glänzendes und leuchtendes Aussehen. PH-Wert sauer

*Shampoo specifico per capelli tinti o colorati. Ravviva e mantiene il colore dei capelli più a lungo, fornendo un aspetto morbido, lucido e luminoso. PH acido.*

1 u.m.vta  
500 box

10 ml

REF.06806



1 u.m.vta  
12 box

1 L

REF.04620

1 u.m.vta  
600 box

10 ml

REF.06659



1 u.m.vta  
12 box

500 ml

REF.06563



NEW  
1 u.m.vta  
12 box

500 ml

REF.07429



### Anti Gelbstich Shampoo für blondes oder weißes Haar BLUE Shampoo per capelli biondi o bianchi

Spezielles antigelbstich Shampoo, um gelbe oder orangefarbene Glanzstellen im blonden Haar zu beseitigen und ein metallischeres und natürlicheres Blond zu erreichen. Gleichzeitig ist es ideal für die Behandlung von weißem und grauem Haar, es hilft, gelbliche Töne zu reduzieren und damit die weiße Farbe des Haares zu verstärken und seine natürliche Weichheit und seinen Glanz wiederzuerlangen.

*Shampoo specifico per eliminare i riflessi giallastri o arancioni dai capelli biondi, ottenendo un biondo più metallico e naturale. Allo stesso tempo, è ideale per il trattamento dei capelli bianchi e grigi, aiuta a ridurre i toni giallastri, esaltando così il colore bianco dei capelli, recuperando la loro naturale morbidezza e lucentezza.*

**NUTRITIVES Shampoo****Shampoo NUTRITIVO**

Shampoo mit Proteinen und Bionährstoffen, die leicht absorbiert und schnell in die Haarstruktur eingearbeitet werden. Enthält Keratin, das die Haarkutikula nährt, repariert und regeneriert und die Neigung zur Bildung von Spliss reduziert und sie vor äußeren Aggressionen schützt. Das Ergebnis ist kräftigeres Haar mit mehr Volumen und mehr Glanz.

*Shampoo con proteine e bionutrienti facilmente assorbibili e rapidamente assimilabili dalla struttura del capello. Contiene cheratina che nutre, ripara e rigenera la cuticola del capello e riduce la tendenza alla formazione delle doppie punte, proteggendolo dalle aggressioni esterne. Il risultato sono capelli più forti, con più volume e più lucentezza.*



1 u.m.vta 500 box

10 ml

REF.06804



1 u.m.vta 12 box

1 L

REF.03552

**ARGAN Restrukturierungslinie****Linea ristrutturante ARGAN**

TASSEL kreiert die New Argan Line, die für die gründliche Behandlung der Haare konzipiert wurde. Restrukturiert die Haarfasern und verleiht ihnen ein glänzendes und regeneriertes Aussehen.

*TASSEL crea la Nuova Linea Argan, pensata per il trattamento in profondità del capello. Ristruttura la fibra capillare donando un aspetto lucido e rigenerato ai capelli.*

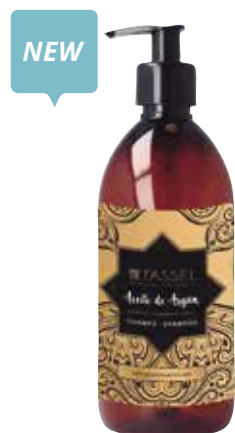

NEW

1 u.m.vta 12 box

500 ml

REF.07165



NEW

1 u.m.vta 12 box

250 ml

REF.07167



NEW

1 u.m.vta 12 box

50 ml

REF.07166

**Shampoo**  
**Shampoo**

SHAMPOO Hilft bei der Regeneration von Haaren und Kopfhaut und wirkt sich positiv auf das Haarwachstum aus. Befeuchtet und mildert Frizz. Verleiht dem Haar mehr Körper und Glanz. Sprödigkeit und Bruch bekämpfen.

*Aiuta nella rigenerazione dei capelli e del cuoio capelluto con un effetto positivo sulla crescita dei capelli. Idrata e ammorbidisce l'effetto crespo. Dona ai capelli più corpo e lucentezza. Combate fragilità e rotture.*

**Balsam**  
**Balsamo**

Intensive Ernährung von den Wurzeln bis zu den Enden, auch über die Kopfhaut. Tief konditionierend und feuchtigkeitsspendend. Reparatur und Wiederherstellung der Haarfasern. Ideal für trockenes und strapaziertes Haar.

*Nutrizione intensa dalle radici alle punte, anche attraverso il cuoio capelluto. Effetto balsamo profondo e idratazione. Riparazione della fibra capillare. Ideale per capelli secchi e danneggiati.*

**Serum**  
**Siero**

Repariert und pflegt Haare. Beseitigen Sie Frizz sofort. Stärkendes Serum, repariert von innen nach außen geschädigtes und gebrochenes Haar.

*Ripara e ammorbidisce i capelli. Elimina l'effetto crespo all'istante. Siero rinforzante, agisce dall'interno verso l'esterno per riparare i capelli danneggiati e spezzati.*

### Stärkendes Shampoo mit Biotin und Keratin Shampoo fortificante con biotina e cheratina

Speziell formuliertes Shampoo und Maske mit Biotin (Vitamin h) und Keratin beugt der Talgsekretion und dem Haarausfall vor, reaktiviert das Haarwachstum und verleiht ihm Stärke und Dicke. Keratin nährt, repariert und regeneriert die Haarschuppenschicht und reduziert die Neigung zur Bildung von Spliss. Das Ergebnis ist kräftigeres Haar mit mehr Volumen und mehr Glanz. PH 5,5.

*Shampoo e maschera appositamente formulati con biotina (vitamina h) e cheratina. La biotina previene la secrezione sebacea e la caduta dei capelli, riattivando la crescita, e apportando forza e spessore. La cheratina nutre, ripara e rigenera la cuticola del capello e riduce la tendenza alla formazione delle doppie punte. Il risultato sono capelli più forti, con più volume e più lucentezza. PH 5.5.*



1 u.m.vta  
12 box

1 L

REF.03663

### Haarstärkende Kur Maschera fortificante

Mit Biotin und Keratin  
Maschera fortificante  
Con biotina e cheratina

1 u.m.vta  
6 box

500 ml

REF.03674



1 u.m.vta  
500 box

10 ml

REF.06805

### CHLOROPHILE Shampoo Shampoo alla CLOROFILLA

1 u.m.vta  
2 box

5 L

REF.04324



Erstellt, um alle Haartypen sanft, häufig und gründlich zu waschen. Verleiht dem Haar mehr Glanz, ein gesünderes Aussehen und einen angenehmen Minzduft.

*Formulato per lavare delicatamente, frequentemente e accuratamente tutti i tipi di capelli. Dona ai capelli più lucentezza, un aspetto più sano e un gradevole profumo di menta.*

### NEUTRALES Shampoo Shampoo NEUTRO

1 u.m.vta  
2 box

5 L

REF.04325



Shampoo für alle Haartypen, besonders geeignet für die tägliche oder häufige Anwendung. Es wäscht das Haar auf sanfte Weise, wobei der Ph-Wert der Haarkutikula erhalten bleibt. Schützt die Kopfhaut und verleiht ihr Gleichgewicht und Gesundheit.

*Shampoo per tutti i tipi di capelli e particolarmente indicato per un uso quotidiano o frequente. Lava i capelli in modo delicato, mantenendo il PH della cute e dei capelli. Protegge il cuoio capelluto donandogli equilibrio e salute.*

### Weichmachende Creme Nutriente

1 u.m.vta  
2 box

5 L

REF.04326



Conditioner mit Pflanzenextrakten, der die Haarfaser repariert, stärkt und das Schuppen der Haarfaser verhindert. Diese Extrakte verleihen dem Haar Weichheit, Glanz und Leuchtkraft und erleichtern das Styling.

*Balsamo con estratti vegetali che riparano, rinforzano e prevengono la desquamazione della fibra capillare. Questi estratti donano ai capelli morbidezza, lucentezza e luminosità, favorendo l'acconciatura..*

### Weichmachende Creme HERBAL CREAM Nutriente HERBAL CREAM

Kraftvoll aufweichend und entwirrend. Es stellt das natürliche Gleichgewicht des Haares wieder her und gibt ihm sein gesundes und natürliches Aussehen zurück. Enthält pflegende Inhaltsstoffe und einen Kräuterduft. Ohne Parabene und Silikone.

*Ha un grande potere ammorbidente e districante. Ripristina il naturale equilibrio dei capelli, ripristinando il loro aspetto sano e naturale. Contiene ingredienti ammorbidenti e un profumo di erbe. Senza parabeni o siliconi.*

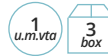

5 L

REF.06682

### Auffrischende Haarkur Maschera riparatrice per capelli

Angereichert mit Arganöl, Keratin und Kollagen restrukturiert und pflegt es trockenes und dehydriertes Haar und verleiht ihm Glanz und Geschmeidigkeit. Repariert Schäden, die durch thermische Einfluss verursacht wurden, und schützt vor Bruch.

*Arricchita con olio di argan, cheratina e collagene che ristrutturano e nutrono i capelli secchi e disidratati, donando lucentezza e morbidezza. Ripara i danni causati dalle aggressioni termiche e li protegge dalle rotture.*



400 ml

REF.06313

### INTENSE BRIGHT COLOR Shampoo Shampoo INTENSE BRIGHT COLOUR

INTENSE BRIGHT COLOUR SHAMPOO ist die Ergänzung der technischen Produktlinie von TASSEL, angereichert mit Arganöl und Keratin. Es ist speziell für trockenes, gefärbtes, gebleichtes Haar und mit feuchtigkeitsspendenden, restrukturierenden und reparierenden Eigenschaften der Haarfaser geeignet. Die ideale Ergänzung zu unserer neuen KUR BRIGHT MASK, die mit Arganöl und Keratin angereichert und so formuliert ist, dass sie als Reparer von geschädigtem Haar wirkt.

*Lo Shampo INTENSE BRIGHT COLOR della linea di prodotti professionali TASSEL, arricchito con olio di argan e cheratina. Particolarmente indicato per capelli secchi, colorati, decolorati, grazie alle sue proprietà idratanti, ristrutturanti e riparatrici della fibra capillare. Il complemento ideale per la nostra NUOVA MASCHERA CAPILAR BRIGHT MASK arricchita con olio di argan e cheratina e formulata per agire come riparatore per i capelli danneggiati.*



5 L

REF.06336

### Shampoospender Dosatore

» Gibt mit jedem Druck 30 ml Shampoo ab  
» Für 5-Liter-Behälter

» Dosa 30 ml di shampo ad ogni pressione  
» Per le taniche da 5 litri



REF.07093



**AROMA SENSATION Shampoos**  
**Shampoo "AROMA SENSATION"**1 u.m.vta  
6 box

Um den Marktbedürfnissen gerecht zu werden, lanciert, erweitert und erneuert TASSEL, mit seinem ständigen Innovationscharakter, seine Linie von Shampoos. NEUTRAL-SHAMPOO mit einem angenehmen Geruch von MELONE, ERDBEERE und KOKOSNUS. Alle sind so formuliert, dass eine tiefe Haar- und Kopfhautwäsche erreicht wird. Seine hohe Konzentration an aktiven Stoffen ermöglicht ein perfektes Waschen. Es verleiht dem Haar mehr Glanz und ein gesünderes Aussehen. Für den täglichen Gebrauch. Ph 5,5.

Per soddisfare le esigenze del mercato, TASSEL, grazie alla sua volontà di costante innovazione, lancia, amplia e rinnova la sua linea di shampoo sfusi. SHAMPOO NEUTRO dal gradevole profumo di MELONE, FRAGOLA e COCCO. Tutti formulati per ottenere un lavaggio profondo dei capelli e del cuoio capelluto. La loro alta concentrazione di principi attivi permette un lavaggio perfetto. Dona ai capelli più lucentezza e un aspetto più sano. Per uso quotidiano. Ph 5,5.

**Melone**  
**Melone****Erdbeere**  
**Fragola****Kokosnuss**  
**Cocco****Haarkur mit Kollagen 1l**  
**Maschera per capelli al collagene 1l**1 u.m.vta  
5 box

## Box mit 12 Behandlungen "wow effect" Confezione con 12 trattamenti "wow effect"



Mit Keratin, Arganöl und Haarseider

Behandlung angereichert mit:

- » **Keratin**, das die Seidigkeit des Haars erhöht, was für eine tiefe Hydratation sorgt, den Glanz intensiviert und hilft, die offenen Spitzen zu schließen. Bewahrt die Farbe und verbessert die Haargesundheit.
- » **Mit Seidenproteinen**: hydratisiert in der Tiefe, revitalisiert gefärbtes Haar und sorgt für Glanz.
- » **Arganöl**, repariert und restrukturiert Haar, das durch äußere Einflüsse beschädigt wurde, macht geschmeidiger, kräftigt und hydratisiert.

Con Cheratina, Olio di Argan e Seta

Trattamento arricchito con:

- » **Cheratina**, che aumenta la setosità dei capelli e produce un'idratazione profonda, intensifica la lucentezza e aiuta a sigillare le doppie punte. Mantiene il colore e migliora la salute dei capelli.
- » **Proteine della seta**, che idratano in profondità, rivitalizzano i capelli colorati e donano lucentezza.
- » **Olio di Argan**, ripara, ristruttura i capelli danneggiati dalle aggressioni esterne, ammorbidisce, nutre e idrata.



NEW

REF.07244



### Reparatur-Explosion für das Haar in 5 Minuten Esplosione riparatrice per capelli in 5 min

Umschlag 1 **Flash-Effekt** + Umschlag 2 **Impact-Effekt**. Mischen Sie die beiden Umschläge und sorgen Sie für eine **REPARATUR-EXPLOSION**. Stellt die Gesundheit Ihres Haars mit nur einer Anwendung wieder her.

**GEBRAUCHSANWEISUNG:** Den Inhalt beider Umschläge in ein Metallgefäß mischen, bis eine homogene Emulsion entsteht. Durch Massieren des Haars von der Wurzel zu den Spitzen auftragen. 5 bis 10 Minuten einwirken lassen, je nach Zustand des Haars, und mit Wasser ausspülen.

Bustina 1 **Effetto flash** + Bustina 2 **Effetto impatto**. Mescolare le 2 bustine per generare una **ESPLOSIONE RIPARATRICE**. Recupera la salute dei tuoi capelli in un'unica applicazione.

**COME USARE:** Mescolare il contenuto di entrambe le bustine in una ciotola non metallica fino ad ottenere un'emulsione omogenea. Applicare massaggiando i capelli dalla radice alla punta. Lasciare agire da 5 a 10 minuti a seconda delle condizioni dei capelli e risciacquare con acqua.

**Keratin-Nährhaarkur**  
**Maschera nutritiva alla cheratina**

Erstellt mit Keratin, das das Haar nährt, pflegt und seine Elastizität erhöht, indem es von der Wurzel bis zu den Spitzen repariert, es vor äußeren Angriffen schützt und die Neigung zur Bildung von Spliss reduziert.

Formula a base di cheratina, che nutre, ammorbidisce e aumenta l'elasticità dei capelli, riparandoli dalle radici alle punte, proteggendoli dalle aggressioni esterne e riducendo la tendenza a formare doppie punte.



100 ml

REF.03435



500 ml

REF.06948



Neue  
Formel  
Nuova  
formula

**Strandset mit Keratin**  
**Kit da spiaggia alla cheratina**

Strandset bestehend aus Sonnenschutzcreme für das Haar, nährender Kur, Holzgriffbürste mit Balg, Plastikamm mit breiten Zinken, Haarklammer, Pinzette zum Zupfen der Augenbrauen und Doppelspiegel mit kleinem Kamm.

Kit da spiaggia composto da crema solare capillare, maschera nutriente, spazzola a soffietto in legno, pettine in plastica a setole larghe, pinza per raccogliere i capelli, pinzetta per depilare le sopracciglia e doppio specchio con pettine.



REF.03519

**BI-PHASIC Tassel**  
**BI-PHASIC Tassel****Vorteile**

- » Hydratation
- » Flexibilität
- » Geschmeidigkeit
- » Verleiht Volumen und Haarkur

**Eigenschaften**

Angereichert mit Leinsamenöl, welches das Haar mit Feuchtigkeit, Flexibilität und Geschmeidigkeit versorgt, sowie Weizenproteinen, die eine ähnliche Wirkung wie Keratin haben. Es macht das Haar elastischer, gibt mehr Volumen und wirkt wie ein natürlicher Conditioner. Speziell für trockenes und geschädigtes Haar.

**Benefici**

- » Idratazione
- » Flessibilità
- » Morbidezza
- » Dona volume e morbidezza

**Che cos'è?**

Balsamo arricchito con lino che fornisce idratazione, flessibilità e morbidezza ai capelli e proteine del grano che hanno effetti simili alla cheratina. Rende i capelli più elastici, con più volume e agisce come un balsamo naturale. Specifico per capelli secchi e danneggiati.



500 ml

REF.07369

NEW



## Hitzeschutz Protettore termico

Anti-Frizz  
Effetto anti-crespo



250 ml

REF.03343



## Locken-Aktivator Attivatore ricci



250 ml

REF.03344



## Flüssiges Keratin Cheratina liquida



250 ml

REF.03554



Spezifische Formel für den Schutz und die Pflege der Haare gegen äußere Einflüsse, die durch Trocknungsgeräte, die heiße Luft erzeugen, wie Haartrockner, Glätteisen und Lockenstäbe, entstehen. Seine Pflegespülung verhindert Kräuseln und macht das Haar handlicher und glänzender, wodurch die statische Aufladung vermieden wird.

*Formula specifica per la protezione e la cura del capello dalle aggressioni prodotte dai dispositivi di asciugatura che generano aria calda, come asciugacapelli, piastre e arricciacapelli. Previene l'effetto crespo, lasciando i capelli più pettinabili e lucenti, evitando così l'effetto antistatico.*

Seine innovative Formel erzeugt einen Film, der die Locken stärkt und belebt, ihnen mehr Definition und Elastizität verleiht und ihnen Feuchtigkeit spendet, ohne sie zu beschweren. Seine konditionierende Wirkung verleiht dem Haar Volumen und Dicke und macht es seidig, glänzend und definiert.

*La sua formula innovativa crea un patina che rinforza e rivitalizza i ricci, donando loro più definizione, più elasticità e idratandoli senza appesantirli. Il suo effetto balsamo apporta volume e spessore, lasciando i capelli setosi, lucenti e vaporosi.*

Flüssiges Keratin nährt, repariert und regeneriert sofort die Haarschuppenschicht. Es enthält Kollagen und Seidenproteine, die eine konditionierende Wirkung verleihen, wodurch gesünderes und kräftigeres Haar erzielt und Volumen, Weichheit und Glanz verbessert werden.

*La cheratina liquida nutre, ripara e rigenera istantaneamente la cute del capello. Contiene collagene e proteine della seta, che apportano un effetto balsamo, ottenendo capelli più sani e forti e migliorando volume, morbidezza e lucentezza.*

## Lovely Curls Tassel Lovely Curls Tassel



### Vorteile

- » Lockendefiniton
- » Maximale Hydratation,
- » Volumen
- » Natürliche Lockerheit für Ihr Haar

### Eigenschaften

Pflegende Creme, die die Locken definiert. Es enthält Panthenol und Weizenproteine. Beseitigt Frizz und bietet definiert die Locken. Maximale Hydratation, Volumen und Lockerheit für Ihr Haar.

### Benefici

- » Definisce i ricci
- » Massima idratazione
- » Volume
- » Movimento naturale dei capelli

### Che cos'è?

Crema balsamo per definire i ricci. Contiene pantenolo e proteine del grano. Elimina l'effetto crespo e definisce i ricci. Massima idratazione, volume e movimento ai tuoi capelli.

NEW

250 ml

REF.07381



**Haar-Serum****Siero All for Hair**

Haarschutzserum, mit Keratin, UV-Filter, Arganöl und Seidenproteinen Kein Spülen.

Siero protettivo per capelli, con cheratina, filtro UV, olio di argan e proteine della seta. Senza risciacquare.

**10 Ergebnis nach einer Anwendung:**

1. Repariert geschädigtes Haar
2. Glanz
3. Hitzeschutz
4. Aufweichend und Entwirrend
5. UV-Schutz
6. Frizz vermeiden
7. Verhindert gespaltene Spitzen
8. Bietet Volumen
9. Erleichtert das Kämmen
10. Erleichtert das Kämmen
11. Feuchtigkeits Tiefenspender

**10 vantaggi in una sola applicazione:**

1. Ripara i capelli danneggiati
2. Dona lucentezza
3. Protettore termico
4. Ammorbidisce e districa
5. Protezione UV
6. Previene l'effetto crespo
7. Previene le doppie punte
8. Dona volume
9. Facilita lo styling
10. Facilita lo styling
11. Idrata in profondità

120  
u.m.vta

120  
box

3 ml

REF.03930

120  
u.m.vta

1  
u.m.vta

12  
box

250 ml

REF.03830

**Volumisierendes Pulver****Volumizzanti**

Ultraleichtes Mattierungspulver zur Erstellung von Texturen. Glatter und matter Effekt. Hält die Frisur und verleiht auch feinem Haar Volumen. Je mehr Sie von dem Produkt anwenden, desto mehr Kontrolle erhalten Sie und desto mehr unglaublichen Halt erhalten Sie. Für einen intensiveren Matteffekt auf das feuchte Haar auftragen, formen und trocknen lassen. Sie können das Produkt auch auf trockenes Haar auftragen, um die Kräuselung zusätzlich zu kontrollieren und die Weichheit zu erhöhen. Angereichert mit Keratin, das die Widerstandsfähigkeit des Haarkeratins fördert.

Opacizzante ultraleggera per dare volume. Morbido e con effetto opaco. Mantiene l'acconciatura e dona volume anche ai capelli fini. Applicando più prodotto, si ottiene un maggior controllo e una incredibile tenuta. Per un effetto opaco più intenso applicare sui capelli umidi modellandoli e lasciandoli asciugare. È inoltre possibile applicare il prodotto sui capelli asciutti per ottenere un ulteriore controllo dell'effetto crespo e una maggiore morbidezza. Arricchito con cheratina che favorisce la resistenza della cheratina capillare.



120  
u.m.vta

1  
u.m.vta

15  
box

10 gr

REF. 06316



120  
u.m.vta

1  
u.m.vta

20  
box

20 gr

REF. 06175

## Wurzeln retuschieren Ritocca le radici



Temporäre Sprühfarbe.

Sofortige Farbe. Bedeckt sofort Wurzeln und graues Haar und fügt sich perfekt in Ihre Farbe ein. Schnelles und sichtbares Trocknen aller Haare. Es geht mit 1 oder 2 Wäschen.

- » Deckt Wurzeln und graues Haar ab
- » Temporäre Färbung
- » Schnell trocken

WIE BENUTZT MAN

VORBEREITUNG: Legen Sie ein Handtuch über die Schultern.

- » Gut schütteln und den Behälter aufrecht halten. Sprühen Sie ca. 15 cm von trockenem Haar. Nicht zu stark verdampfen, eine kleine Menge ist ausreichend. 1 Minute trocknen lassen und kämmen. Sprühen Sie ein zweites Mal für eine intensivere Farbe.
- » Verwenden Sie nach dem Sprühen der Wurzeln einen Kamm, um das Produkt von Ihren Wurzeln etwa 4 oder 5 Zentimeter entlang der Länge zu verteilen, damit Sie ein natürlicheres Ergebnis erzielen.

Colorazione spray temporanea.

Colore istantaneo. Copre istantaneamente radici ed i capelli grigi, fondendosi perfettamente con il tuo colore. Si asciuga molto velocemente, visibile su tutti i capelli. Si pulisce, con 1 o 2 lavaggi.

- » Copre radici e capelli grigi
- » Colorazione temporanea
- » Asciugatura rapida

NEW



COME USARE

PREPARAZIONE: Mettere un asciugamano sulle spalle.

- » Agitare bene lo spray e mantenerlo in posizione verticale, a circa 15 cm dai capelli asciutti. Non vaporizzare eccessivamente, una piccola quantità è sufficiente. Lasciate asciugare per 1 minuto e pettinare. Spruzzare una seconda volta per un colore più intenso.
- » Dopo aver colorato le radici, distribuire il prodotto dalle radici con un pettine di circa 4 o 5 centimetri su tutta la lunghezza del capello, in modo da ottenere un risultato più naturale.



REF.07277/50

Schwarz  
Nero



REF.07277/67

Dunkelbraun  
Castano  
scuro



REF.07277/65

Hellbraun  
Castano chiaro



REF.07277/66

Dunkelblond  
Biondo scuro



REF.07277/76

Hellblond  
Biondo chiaro



REF.07277/60

Rot  
Rosso



## Haarfasern Fibre capillari



22 gr

- » Mit Dosiermöglichkeit
- » Für Männer und Frauen. Ideal bei Haardichteverlust. Tarnung von Bereichen mit wenig Haar schnell und natürlich
- » Haftet am Haar und verleiht ihm mehr Volumen und Dicke
- » Einfaches Auftragen durch Schütteln des Glases über die Applikationsfläche
- » Erhältlich in 6 Farben: schwarz, dunkelbraun, mittelbraun, hellbraun, dunkelblond und hellgrau passend zur natürlichen Haarfarbe

- » Con dosatore
- » Per uomini e donne. Ideale contro la perdita di densità. Nasconde le aree CON pochi capelli in modo rapido e naturale
- » Aderisce ai capelli donando loro maggior volume e spessore
- » Si applica facilmente agitando il barattolo sull'area di applicazione
- » Disponibile in 6 colori: nero, castano scuro, castano medio, castano chiaro, biondo scuro e grigio chiaro che si adattano al tono del colore naturale dei capelli



Schwarz · Nero

REF.06436/50

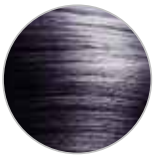

Hellgrau · Grigio chiaro

REF.06436/72

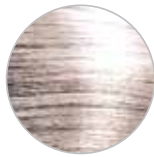

Dunkelblond · Biondo scuro

REF.06436/66



Dunkelbraun · Castano scuro

REF.06436/67



Mittelbraun · Castone medio

REF.06436/76

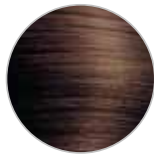

Hellbraun · Castone medio

REF.06436/65

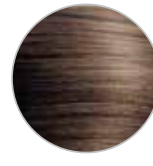

## Fixier-Zerstäuber Atomizzatore per fibra capillare



REF.07208

NEW

- » Benutzerfreundlich
- » Ermöglicht eine gleichmäßigere Verteilung der Haarfasern an bestimmten Stellen.
- » Ermöglicht, dass die Fasern viel leichter an Ihrem natürlichen Haar anhaften. Es wird eine geringere Menge des Produkts benötigt, um den gewünschten Look zu erzielen.
- » Leicht zu lagern

### VERWENDUNG:

Geben Sie die Haarfasern in die Glasflasche und bringen Sie den Zerstäuber an, um sie zu pulverisieren. Drücken Sie hierfür die Pumpe nach oben und nach unten.

- » Facile da usare
- » Consente una distribuzione più uniforme delle fibre capillari in zone specifiche.
- » Permette alle fibre di aderire ai tuoi capelli naturali molto più facilmente. È necessario meno prodotto per ottenere l'aspetto desiderato.
- » Facile da riporre

### COME USARE:

Versare le fibre dei capelli nella bottiglia di vetro e sistemare l'atomizzatore per nebulizzarle. Premere la pompetta a tale scopo.



## Haarfaser-Lack

### Lacca per fibra capillare



Für maximale Fixierung und Unterstützung der Fasern

*Per una massima fissazione e tenuta delle fibre*

100 ml

REF.06649



## Verkaufsträger haarfasern (als geschenk)

### Espositore per fibre capillari (regalo)



» Umfasst 6 Farbtöne für haarfasern + fixierlack

» Ref. 06436/50 Schwarz 22 g - Ref. 06436/72 Hellgrau 22 g - Ref. 06436/66 Dunkelblond 22 g - Ref. 06436/67 Dunkelbraun 22 g - Ref. 06436/76 - Mittelbraun 22 g - Ref. 06436/65 Hellbraun 22 g

» Ref. 06649 Fixierlack haarfasern 100 ml.

» Include 6 tonalità di fibra capillare + lacca fissante

» Rif. 06436/50 Nero 22g. - Rif. 06436/72 Grigio chiaro 22g. - Rif. 06436/66 Biondo scuro 22g. - Rif. 06436/67 Castano scuro 22g. - Rif. 06436/76 Castano medio 22g. - Rif. 06436/65 Castano chiaro 22g. - Rif. 06649 Lacca fissante fibre capillari 100 ml.



NEW

REF.07801



**Tassel Kosmetik-Lacke, ideal für Steckfrisuren**  
**Lacche Tassel Cosmetics, ideali per acconciature**



» Normal  
 » Normale



300 ml

REF.06268

750 ml

REF.06265

» Stark  
 » Forte



300 ml

REF.06269

750 ml

REF.06266

Industrias Oriol 1942, S.L. bringt die neue Veredelungslinie "TASSEL HAARLACKE" auf den Markt, die mit Arganöl angereichert ist, das reich an ungesättigten Fettsäuren, Vitamin E sowie an Beta-Carotinoiden ist und eine hohe Hydratationskapazität besitzt, die das Haar erhält und ihm einen natürlichen Glanz und Schönheit verleiht.

Seine aktualisierte Zusammensetzung, die sehr substanziiell für das Haar ist, ermöglicht ein rationelleres Haarformen und bildet einen flexibleren und elastischeren Film, der in der Lage ist, das Haar vor äußeren Einflüssen wie Wind oder Feuchtigkeit zu schützen. Dank seiner Arganölkomponekte kann jede Art von Frisur mit dem gewünschten Glanz, Volumen und Geschmeidigkeit erhalten werden.

Seine LONG LASTING Wirkung macht es ideal zum Glätten, für Locken, für Volumen, zum Hochstecken, und um unendlich viele Frisuren zu kreieren und den ganzen Tag auf natürliche Weise und ohne die Frisur zu belasten, zu Sie zu pflegen. Seine Zusammensetzung erlaubt ein leichtes Entfernen mit einem leichten Pinsel. Hinterlässt keine Rückstände.

*Industrias Oriol 1942, S.L. lancia la nuova linea "LACCHE PER CAPELLI TASSEL", arricchite con olio di argan, un principio attivo ricco di acidi grassi insaturi, vitamina E, oltre a beta carotenoidi, che forniscono un'elevata capacità di idratazione e si prendono cura dei capelli donando loro una naturale lucentezza e bellezza.*

*La loro formula innovativa, molto nutritiva per i capelli, consente acconciature più strutturate formando una pellicola più flessibile ed elastica in grado di proteggere i capelli dagli agenti esterni come vento o umidità, e permettendo di mantenere qualsiasi tipo di acconciatura con la lucentezza, il volume e la setosità desiderati grazie al suo componente di olio di argan.*

*Il loro effetto LUNGA DURATA le rende ideale per lisciare, arricciare, volumizzare, acconciare, creare innumerevoli acconciature e mantenerle per tutta la giornata in modo naturale e senza appesantire l'acconciatura. La loro composizione permette una facile rimozione con una leggera. Non lascia residui.*

**Tassel Kosmetiklacke, ideal für Steckfrisuren**  
**Lacche Tassel Cosmetics, ideali per acconciature**



- » Extra stark
- » Extra forte



300 ml

REF.06270

750 ml

REF.06267



- » ECO
- » ECO

300 ml

REF.06271

LACA ECO TASSEL gibt dem Haar eine ausgezeichnete Fixierung, die ihm einen natürlichen Glanz verleiht und es gleichzeitig vor äußeren Einflüssen wie Wind, Feuchtigkeit usw. schützt. Mit den gleichen Eigenschaften wie die bisherigen Lacke, aber ohne umweltverschmutzende oder schädliche Gase für die Umwelt.

*LACA ECO TASSEL dona ai capelli un'ottima tenuta e una lucentezza naturale proteggendoli dagli agenti esterni come vento, umidità, ecc. Con le stesse caratteristiche delle precedenti lacche, ma senza gas inquinanti o nocivi per l'ambiente.*



# Spangen und klammern

MOLETTE  
E FERMAGLI

*Haarnadeln, Haarspangen,  
Haarklammern, Haardiademe,  
Haarklemmen, Haargummis...*

*Mollette, fermagli, forcine,  
cerchietti, pinze, elastici...*



## Geschichte des Clips und seines Hintergrunds

### Storia delle clip e dei suoi predecessori

Der Ursprung der Nadeln zum Feststecken des Haars geht auf das Assyrische Reich und das alte Ägypten zurück, 25 Jahrhunderte v.Chr. Die gefundenen Überreste zeigen, dass es Nadeln aus Holz, Elfenbein, Bronze und anderen Metallen gab, und dass einige mit wertvollen Steinen dekoriert waren, was sie zu Luxusgegenständen machte.

Im alten China wurde der Übergang der jungen Leute in das Erwachsenenleben mit einer Zeremonie inszeniert, bei der ihnen eine Nadel für das Haar übergeben wurde.

Die Clip-Haarnadel, so wie wir sie heute kennen, wurde nach dem Ersten Weltkrieg von Luis Marcus erfunden, einem Kosmetikfabrikanten aus San Francisco. Die Verwendung des Clips war weit verbreitet, als die Frisur namens "Bob" in Mode kam, ein gerader Haarschnitt bis in Höhe des Kinns (daher ihr englischer Name "Bobby pin").



*L'origine degli aghi per tenere i capelli risale all'impero assiro e all'antico Egitto, 25 secoli prima di Cristo. I resti trovati mostrano che esistevano aghi di legno, avorio, bronzo e altri metalli e che alcuni erano decorati con pietre preziose, diventando così oggetti di lusso.*

*Nell'antica Cina, il passaggio delle giovani donne all'età adulta era rappresentato da una cerimonia in cui veniva loro consegnato un ago per capelli.*

*La forcina a clip come è conosciuta oggi è stata inventata da Luis Marcus, un produttore di cosmetici di San Francisco, dopo la prima guerra mondiale. L'uso della clip si diffuse quando divenne di moda l'acconciatura conosciuta come "bob" o "caschetto", un taglio di capelli dritto fino al mento (da cui il nome in inglese "Bobby pin").*



### Ziel und Form

#### Obiettivo e forma

Der Clip ist ein kleines Teil aus gebogenem Stahl, das zur Aufnahme des Haars und zur Fixierung der Frisur verwendet wird.

*La forcina è un piccolo pezzo di acciaio piegato utilizzato per raccogliere i capelli e tenere in posizione l'acconciatura.*



Die Öffnung ist der offene Teil des Clips, durch den das Haar passen muss.

*La bocca È la parte aperta della forcina, dove i capelli devono entrare.*

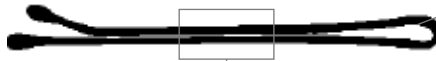

Die beiden Zinken des Clips drücken und stützen die Haarsträhne und befestigen den Clip.

*Le due asticelle della clip sono quelle che tengono premuta la ciocca e tengono la forcina in posizione.*

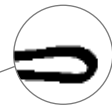

Das Auge des Clips hat zwei Funktionen:

Eine möglichst große Anzahl an Haaren aufzunehmen, und den Druck der Zinken zu erleichtern.  
*L'occhio della forcina ha due funzioni: Afferrare la massima quantità di capelli possibile e facilitare la pressione delle asticelle.*

### Herstellungsprozess

#### Processo di fabbricazione

Die Clips, die wir herstellen und vertreiben, sind aus Stahldraht mit einem hohen Gehalt an Carbon. Diese Legierung macht sie härter, flexibler und widerstandsfähiger, und ermöglicht ihre Verwendung für zahlreiche Zwecke, ohne die Kraft des Drucks der Zinken zu verlieren.

Der Herstellungsprozess unserer Clips verläuft in verschiedenen Schritten:

- 1.- Ziehen des Drahts
- 2.- Walzen
- 3.- Biegen des Clips
- 4.- Kugel und Anstrich
- 5.- An- oder Einpassung

*Le forcine che produciamo e distribuiamo sono realizzate in filo di acciaio, ad alto contenuto di carbonio. Questa lega le rende più dure, flessibili e resistenti, permettendone l'utilizzo in più occasioni senza perdere la forza di pressione delle asticelle.*

*Il processo di produzione delle nostre forcine segue diversi passaggi:*

- 1.- Trafilatura
- 2.- Laminatura
- 3.- Piegatura
- 4.- Gomma e verniciatura
- 5.- Confezionamento

**DOPPELWELLEN Haarnadel**  
**Mollete a DOPPIA ONDA**

- » Kurze **DOPPELWELLEN**-Haarnadel für besseren Haarbefestigung und langanhaltende Steckfrisuren
- » *Molletta ondulata per una migliore tenuta dei capelli e per acconciature di lunga durata*

- » Karton 24 Haarnadeln
- » *Confezione 24*



REF. 04934    REF. 04934/50

- » Schachtel 300 Haarnadeln
- » *Confezione 300*

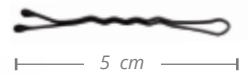

REF. 04935    REF. 04935/50

**Matte Anti-Rutsch-Haarnadeln**  
**Mollette satin antiscivolo**

- » Karton 24 Haarnadeln
- » Mit Kugel
- » *Confezione 24*



REF. 04484/50    REF. 04484/58    REF. 04484/69    REF. 04484/72

- » Schachtel 300 Haarnadeln
- » Mit Kugel
- » *Confezione 300*



REF. 04522/50    REF. 04522/69

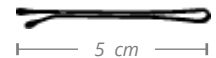
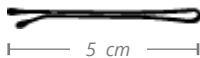

## Haarnadel · Mollette

**MATTEHAARNADEL gewellt**  
**Mollette SATIN ondulate**1  
u.m.vta  
288  
box1  
u.m.vta  
16  
box

- » Karton 12 Haarnadeln
- » Mit Kugel

REF. 07133 REF. 07133/50

» Confezione 12

- » Schachtel 200 Haarnadeln
- » Mit Kugel

REF. 07134 REF. 07134/50

» Confezione 200

NEW



NEW

**Haarnadel gewellt**  
**Mollette ondulate**12  
u.m.vta  
120  
box1  
u.m.vta  
16  
box

- » Karton 24 Haarnadeln
- » Mit Kugel

REF. 01609 REF. 01609/50

» Confezione 24

- » Kasten 300 Haarnadeln
- » Mit Kugel

REF. 01610 REF. 01610/50

» Confezione 300

**Haarnadel gewellt**  
**Mollette ondulate**12  
u.m.vta  
96  
box1  
u.m.vta  
16  
box

- » Karton 24 Haarnadeln
- » Mit Kugel

REF. 01611 REF. 01611/50

» Confezione 24

- » Schachtel 150 Haarnadeln
- » Mit Kugel

REF. 01612 REF. 01612/50

» Confezione 150

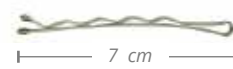

### Haarnadel Box Confezioni di mollette



- » 700 Mini-Haarnadeln
- » Ohne Kugel

REF. 04088    REF. 04088/50

- » 700 mini-mollette

- » 300 Haarnadeln
- » Ohne Kugel

REF. 01604    REF. 01604/50

- » 300 mollet

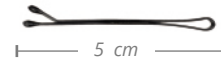

- » 200 Haarnadeln
- » Mit Kugel

REF. 01606    REF. 01606/50

- » 200 mollete

- » 150 Haarnadeln
- » Mit Kugel

REF. 01608    REF. 01608/50

- » 150 mollete

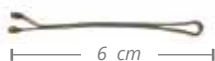

### Spangen auf Karton Confezione clip



- » 24 kleine schwarze Spangen
- » 24 clip nere

REF. 03482

- » 24 LeuchtfarbenSpangen
- » 24 clip fluorescenti

REF. 03481



- » 12 kleine schwarze Spangen
- » 12 clip nere

REF. 03480

- » 12 kleine Leuchtfarben Spangen
- » 12 clip fluorescenti

REF. 03479



**JO-JO-Haarnadeln auf Karton**  
Confezione mollette yo-yo

- » 24 Haarnadeln
- » Mit Kugel
- » 24 mollette



Ondina

30  
u.m.vta30  
box

REF. 01602

REF. 01602/50

**ONDINA Haarnadeln auf Karton**  
Confezione mollette ONDINA

- » 12 Haarnadeln
- » Mit Kugel
- » 12 mollette

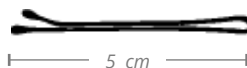
60  
u.m.vta60  
box

REF. 01603

REF. 01603/50

**Ondina Haarnadeln auf Karton**  
Confezione mollette Ondina

- » 12 Haarnadeln
- » 12 mollette

REF. 01601

- » 24 Mini-Haarnadeln
- » 24 mini-mollette

REF. 02879

- » 12 Haarnadeln
- » 12 mollette

REF. 01607



REF. 01601/50

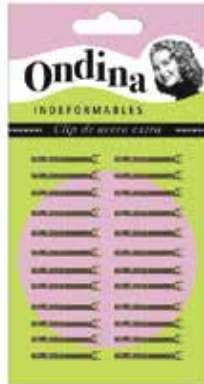

REF. 02879/50

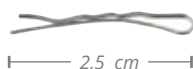

REF. 01607/50

**EUROSTIL- Haarnadeln auf Karton**  
Confezione mollette EUROSTIL

- » 12 Haarnadeln
- » Mit Kugel
- » 12 mollette

60  
u.m.vta60  
box

REF. 01605

REF. 01605/50



**Schachtel mit Haarnadeln**  
**Confezioni di forcine**1  
u.m.vta  
40  
box» 72 Dutzend Haarnadeln mit Kugel  
» 75 Dozzine di mollette

REF. 01856

REF. 01856/50

» Mit Kugel, 200 gr  
» 200 gr

REF. 01863

REF. 01863/50



| 4,8 cm |



| 5 cm |

» 72 Dutzend Haarnadeln  
» 72 dozzine di mollette

REF. 01855

REF. 01855/50

» Mit Kugel, 200 gr  
» 200 gr

REF. 01862

REF. 01862/50



| 5,9 cm |



| 6 cm |

**Schachtel mit 200 g Haarklammern**  
**Confezione da 200 gr di forcine**1  
u.m.vta  
70  
box» 600 Haarklammern  
» 600 forcine

REF. 01857

REF. 01857/50

» 150 Haarklammern  
» 150 forcine

REF. 01858

REF. 01858/50



| 4,9 cm |



| 5 cm |

» 340 Haarklammern  
» 340 forcine

REF. 01861

REF. 01861/50

» 150 Haarklammern  
» 150 forcine

REF. 01860

REF. 01860/50



| 5 cm |



| 6 cm |

» 160 Haarklammern  
» 160 forcine

REF. 01859

REF. 01859/50



| 7 cm |

» 95 - 100 Haarklammern  
» 95 - 100 forcine

REF. 04327

REF. 04327/50

» 95 - 100 Haarklammern  
» 95 - 100 forcine

REF. 04323

REF. 04323/50

1  
u.m.vta  
150  
box

| 7,5 cm |



| 8,5 cm |



### Packung Haarklammern Confezione di forcine

- » 20 Haarklammern, nicht sichtbar
- » 20 forcine invisibili

20  
u.m.vta

20  
box

REF. 07131

REF. 07131/50

### Schachtel Haarklammern Confezioni di forcine

- » 400 Haarklammern, nicht sichtbar
- » 400 forcine invisibili

1  
u.m.vta

16  
box

REF. 07132

REF. 07132/50

NEW

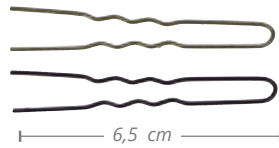

NEW

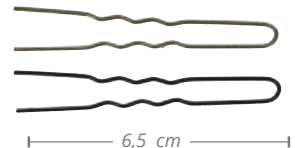

30  
u.m.vta

30  
box

- » 20 kleine, gewellte Haarklammern, nicht sichtbar

- » 20 forcine ondulate piccole invisibili

REF. 04089

REF. 04089/50

- » 500 kleine gewellte Haarklammern, nicht sichtbar

- » 500 forcine ondulate piccole invisibili

REF. 04087

REF. 04087/50

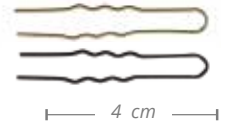
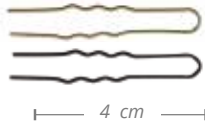

- » 20 Haarklammern, nicht sichtbar
- » 20 forcine invisibili

REF. 00030

REF. 00030/50

- » 400 Haarklammern, nicht sichtbar
- » 400 forcine invisibili

REF. 01616

REF. 01616/50

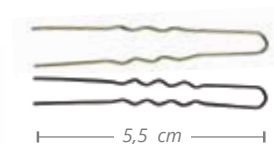
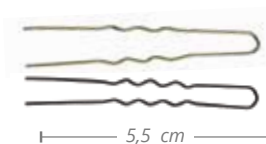

### Packung Haarklammern Confezione di forcine

- » 20 Haarklammern, nicht sichtbar
- » 20 forcine invisibili

12 u.m.vta  
20 box

REF. 00701 REF. 00701/50



### Schachtel Haarklammern Confezioni di forcine

- » 400 Haarklammern, nicht sichtbar
- » 400 forcine invisibili

1 u.m.vta  
16 box

REF. 01617 REF. 01617/50



12 u.m.vta  
12 box

- » 20 glatte Haarklammern für Dutt

- » 20 forcine semplici

REF. 04532 REF. 04532/50



- » 150 glatte Haarklammern für Dutt

- » 150 forcine semplici

REF. 04539 REF. 04539/50



12 u.m.vta  
12 box

- » 20 gewellte Haarklammern, nicht sichtbar

- » 20 forcine ondulate invisibili

REF. 04533 REF. 04533/50

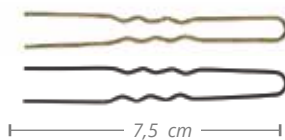

- » 150 gewellte Haarklammern, nicht sichtbar

- » 150 forcine ondulate invisibili

REF. 04540 REF. 04540/50

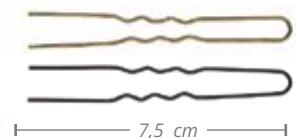

1 u.m.vta  
16 box

### Packung Haarklammern Confezione di forcine

» 10 gebogene  
Haarklammern für Dutt

» 10 forcine ricurve



REF. 04534

REF. 04534/50



### Schachtel Haarklammern Confezioni di forcine

» 150 gebogene  
Haarklammern

» 150 forcine ricurve



REF. 04541

REF. 04541/50



12  
u.m.vta 240  
box

» 10 gebogene  
Haarklammern, nicht  
sichtbar

» 10 forcine ricurve  
invisibili



REF. 04535

REF. 04535/50



» 150 gebogene  
Haarklammern, nicht  
sichtbar

» 150 forcine ricurve  
invisibili



REF. 04542

REF. 04542/50



12  
u.m.vta 240  
box

» 20 gewellte Haarklammern,  
nicht sichtbar

» 20 forcine ondulate invisibili



REF. 04531

REF. 04531/50

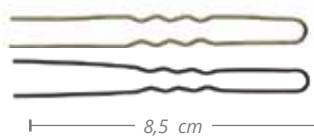

» Schachtel 150 gewellte  
Haarklammer, nicht  
sichtbar

» Confezione 150 forcine  
ondulate invisibili



REF. 04538

REF. 04538/50

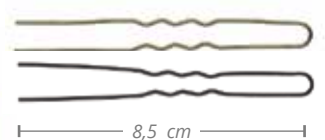

### Packung Haarklammern Confezione di forcine

- » 20 glatte Haarklammern für Dutt
- » 20 forcine semplici



12  
u.m.vta

240  
box

REF. 04530 REF. 04530/50



### Schachtel Haarklammern Confezioni di forcine

- » 150 glatte gebogene Haarklammern
- » 150 forcine semplici

1  
u.m.vta

16  
box

REF. 04537 REF. 04537/50



12  
u.m.vta

240  
box

- » 6 gebogene Haarklammern
- » 6 forcine ricurve

REF. 04529 REF. 04529/50



- » 75 gebogene Haarklammern
- » 75 forcine ricurve

REF. 04536 REF. 04536/50

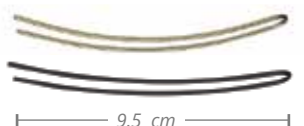

### Haarklammer mit Perle Forcine con perla

12  
u.m.Vta

240  
box

- » 6 große Zier-Haarklammern mit weißer Perle
- » 6 forcine con perla bianca grande

REF. 03209 REF. 03209/50

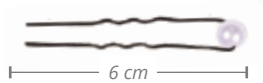

- » 12 Zier-Haarklammern mit kleiner weißer Perle
- » 12 forcine con perla bianca piccola

REF. 03212 REF. 03212/50

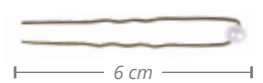

12  
u.m.Vta

120  
box

- » 6 Zier-Haarklammern mit großer silberner Perle
- » 6 forcine con perla argento grande

REF. 03210 REF. 03210/50

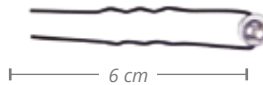

- » Packung mit 12 Zier-Haarklammern mit kleiner silberner Perle
- » Confezione da 12 forcine con perla argento piccola

REF. 03213 REF. 03213/50



- » 6 Zier-Haarklammern mit großer goldener Perle
- » 6 forcine con perla dorata grande

REF. 03211 REF. 03211/50

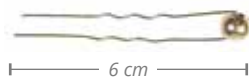

- » 12 Zier-Haarklammern mit kleiner goldener Perle
- » 12 forcine con perla dorata piccola

REF. 03214/50



**Magnetisches Armband**  
**Braccialetto magnetico**

Dank unseres Magnetarmbandes haben Sie alle Haarnadeln und Haarklammern immer griffbereit, um bequemer arbeiten zu können.

*Per lavorare con più comfort, avere tutte le mollette e le forcine a portata di mano grazie al nostro braccialetto magnetico.*



REF. 03631

Magnetisches Armband  
Braccialetto magnetico

**Schachtel mit Metall Klemmen**  
**Confezioni becchi in metallo**

- » 120 kleine Klemmen
- » Breiter Kopf
- » Ref. 92

REF. 01657

- 120 kleine Klemmen
- Schmäler Kopf
- Ref. 91

REF. 01656

- » 120 becchi piccoli
- » Testa larga
- » Rif. 92

- » 120 becchi piccoli
- » Testa stretta
- » Rif. 91



- » 120 zweischenklige Klemme
- » Ref. 94

REF. 01658

- » 120 mittlere Klemmen
- » Ref. 90

REF. 01655

- » 120 becchi a doppia levetta
- » Rif. 94

- » 120 becchi medi
- » Rif. 90



- » 120 große Klemmen
- » Ref. 95

REF. 01659

- » 60 gebogene Klemmen
- » Ref. 93

REF. 01830

- » 120 becchi grandi
- » Rif. 95

- » 60 becchi ricurvi
- » Rif. 93

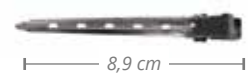

**12 Metallklemmen S**  
*Dodic becchi in metallo S*12  
u.m.vta 96  
boxS  
REF. 00057

4,5 cm

M  
REF. 00058

5 cm

L  
REF. 00059

6,2 cm

**12 Edelstahl-klemmen**  
*Dodici becchi in acciaio inossidabile*» P-20  
» P-2012  
u.m.vta 96  
box

S

REF. 01641



5,3 cm

» P-30  
» P-3012  
u.m.vta 96  
box

M

REF. 01642



6,7 cm

» P-50-Kurve  
» Curvo P-501  
u.m.vta 100  
box

L

REF. 01647

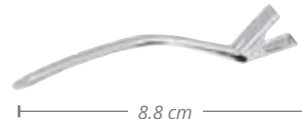

8,8 cm

**Karton Klemmen**  
*Confezione di becchi*» 6 Metall-Trennklemmen  
» Verchromt12  
u.m.vta 36  
box

REF. 00804

» 6 becchi separatori in  
metallo  
» Cromati

11,7 cm

» 6 gebogene  
Klemmen

» 6 becchi ricurvi

12  
u.m.vta 36  
box

REF. 00093



11,7 cm

» 6 Metall-Trennklemmen  
» Farbige» 6 becchi separatori in  
metallo  
» Colori12  
u.m.vta 36  
box

REF. 00803



11,7 cm



## Karton 10 Metallklemmen

### Confezione 10 Becchi in metallo

12  
u.m.vta

96  
box

- » Doppelte Schenkel Klemmen  
» Becchi in metallo doppio

S

REF. 00094



4,5 cm

M

REF. 00090



5,5 cm

L

REF. 00095



6,5 cm

## Karton-Metallklemmen

### Confezione becchi in metallo

- » 10 kleine Metallklemmen  
» Schmäler Kopf

12  
u.m.vta

96  
box

- » 10 becchi piccoli in metallo  
» Testa stretta

S

REF. 00091



4,5 cm

- » 10 kleine Metallklemmen  
» Breiter Kopf

12  
u.m.vta

96  
box

- » 10 becchi piccoli in metallo  
» Testa larga

S

REF. 00092



4,5 cm

- » 12 gebogene Aluminium-Klemmen

12  
u.m.vta

96  
box

- » Dodici becchi ricurvi in alluminio

REF. 00054

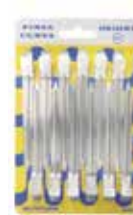

8,8 cm

- » 6 gebogene Kunststoffklammern

1  
u.m.vta

100  
box

- » Farbig  
» 6 becchi ricurvi in plastica  
» Colori

REF. 00055



8,3 cm

- » 6 professionelle Kunststoffklemmen

50  
u.m.vta

50  
box

- » 6 becchi professionali in plastica

REF. 00075



12 cm

- » 6 Kunststoffklemmen Herzform

12  
u.m.vta

48  
box

- » 6 becchi in plastica a forma di cuore

REF. 00086



9,8 cm

**Schachtel mit 60 kleinen Plastikklammen**  
Confezione da 60 fermagli in plastica piccoli

6 cm



REF. 00046

**Schachtel mit 60 mittleren Kunststoffklammen**  
Confezione da 60 fermagli in plastica medi

6,22 cm



REF. 00056

**Schachtel mit 60 großen Plastikklammen**  
Confezione da 60 fermagli in plastica grandi

6,53 cm



REF. 00066

**Set Frisur Kunststoffklammen**  
Set per acconciature

6 cm



REF. 00687

**Hilfs-Klemmen**  
**Pinza assistente**

REF. 04369

Hält das Haar leicht, ohne es zu verheddern und ohne die Frisur zu beschädigen. Schlichtes und doch elegantes Design.

Ein Teil der Klemme hält einen Strang und der andere Teil mit Borsten hält einen anderen Strang. Es ist, als hätte man eine Salonassistentin zu Hause. Um eine Strähne zu färben oder herzustellen, folgen Sie den nachstehenden Anweisungen:

1. einen Mittelscheitel im Haar machen und dann die Farbe auftragen

Trennen Sie die erste Haarsträhne ab, halten Sie es mit der Hilfsklemme fest und tragen Sie dann die Farbe auf diese Strähne auf.

3. das nächste Büschel herausziehen, auf die Klemme legen und mit den Zinken festhalten

4. Wiederholen Sie die Operation, bis die Behandlung abgeschlossen ist

*Tiene i capelli facilmente senza aggrovigliarli e senza rovinare l'acconciatura. Design semplice ed elegante.*

*È come avere un professionista di un salone di bellezza un'altra ciocca. Per tingere o fare delle meches, segui le istruzioni:*

1. Fai una riga centrale tra i capelli e poi applica il colore

2. Separa la prima ciocca di capelli, fissala utilizzando la pinza ausiliaria e quindi applica il colore a questa ciocca

3. Separa la ciocca successiva, posizionala sulla pinza e tienila saldamente usando le punte

4. Ripeti l'operazione fino al completamento dell'applicazione del trattamento



11 cm

» Blisterpackung mit 2 speziellen Trennklemmen  
» Blister 2 mollette speciali di separazione

**Box Anti-Rutsch Klemmen**  
**Confezione becchi antiscivolo**

» 4 Anti-Rutsch-Klemmen  
» Mit Gummi

» 4 fermagli antiscivolo  
» Con elastico



REF. 04368



11 cm

» 6 Anti-Rutsch-Klemmen  
» Mit Gummi

» 6 Becchi antiscivolo  
» Con elastico



REF. 04376



11 cm

**Schachtel mit 6 rostfreien Klemmen**  
**Confezione pinze antiossidanti**

» Mit Zähnen  
» Dentati



REF. 03259



10 cm

**Beutel mit 6 Metall-Kunststoff-Klemmen**  
**Confezione da 6 becchi in metallo-plastica**

- » Farbsortiment
- » Assortimento di colori



S

REF. 02525/99

**Beutel mit 4 Klemmen DRAGON**  
**Buste da 4 pinze DRAGON**

REF. 04374



REF. 03059



REF. 04375

**Beutel mit 6 schwarzen Plastikklammern**  
**Busta da 6 becchi neri in metallo**

- » Mit Gummi
- » Con gomma



REF. 02526

**Schachtel mit 6 Anti-Rutsch-Klemmen**  
**Confezione da 6 becchi antiscivolo**

- » Mit Gummi
- » Con elastico



REF. 04741

**Karton 4 Klemmen mit schwarzem Gummi**  
**Confezione 4 fermagli con gomma nera**

- » Schwarze Klemmen mit einem Gummiband, um keine Abdrücke auf den Haaren zu hinterlassen. Sehr nützlich für die Haarentfernung in Make-up-Sitzungen, da sie keine Spuren hinterlassen.

- » Fermagli neri con gomma per non lasciare segni sui capelli. Molto utili per separare i capelli nelle sedute di trucco poiché non lasciano segni.

REF. 06388



6 cm

REF. 06389



8,2 cm

**Beutel mit 12 Klemmen**  
**Busta da 12 pinzette**1 u.m.vta  
20 boxS ●  
REF. 04421S ●  
REF. 04422L ●  
REF. 04423L ●  
REF. 04424**Beutel mit 6 Heftklemmen mit großem Klemmbereich aus Kunststoff**  
**Busta da 6 pinzette con ampio separatore in plastica**12 u.m.vta  
48 box● ● ● ● ● ●  
REF. 00081● ● ● ● ● ● ● ● ● ● ● ●  
REF. 00081/76●  
REF. 00081/50**Beutel mit 6 großen Heftklemmen, Farbsortiment**  
**Busta da 6 pinzette in plastica grandi, colori assortiti**30 u.m.vta  
30 box● ● ● ● ● ●  
REF. 00078●  
REF. 00078/51●  
REF. 00078/53**Klemmen herz, super-mini**  
**Mini-pinzette a cuore**12 u.m.vta  
600 box● ● ● ● ● ●  
REF. 00143●  
REF. 00143/50●  
REF. 00143/51**Beutel mit 6 Trennklemmen**  
**Busta da 6 pinzette di separazione**1 u.m.vta  
20 box●  
REF. 04738

### Supergroße Klammer Herz

Pinzetta con cuori super grande

6  
u.m.vta

72  
box



10,8 cm

XL ●

REF. 00073/51



10,8 cm

XL ●

REF. 00073/50

### Große Klammer Herz

Pinzetta con cuori grande

6  
u.m.vta

120  
box



8,5 cm

L ●

REF. 00071/51



8,5 cm

L ●

REF. 00071/50

### Klammer Herz klein

Pinzetta con cuori piccola

12  
u.m.vta

120  
box



5,9 cm

S ●

REF. 00100/50



5,9 cm

S ●

REF. 00100

» Marmorierte Farben  
» Colori marmorizzati



5,9 cm

S

REF. 00100/52

### Klammer Herz, mini

Mini-pinzetta con cuori

12  
u.m.vta

600  
box



3,4 cm

XS ●

REF. 00072



3,4 cm

XS ●

REF. 00072/52

**Beutel mit 6 Aluminiumklammern**  
*Busta da 6 pinzette in alluminio*

12  
u.m.vta

96  
box



8,9 cm

L

REF. 00070



7,6 cm

S

REF. 00080

**Beutel 12 Kunststoffklammern, groß**  
*Busta da 12 pinzette in plastica, grandi*

12  
u.m.vta

36  
box



8 cm

L

REF. 00084

**Beutel mit 6 Klammern, klein, Plastik**  
*Busta da 6 pinzette in plastica, piccole*

12  
u.m.vta

48  
box



5,6 cm

S

REF. 00082



8 cm

L

REF. 00084/50



5,6 cm

S

REF. 00082/76

**Beutel mit 6 Klammern, große Kunststoff farbig**  
*Busta da 6 pinzette in plastica, grandi a colori assortiti*

12  
u.m.vta

36  
box



8,2 cm

REF. 00083

**Stirnband aus Polyamid, farblich sortiert**  
*Cerchietto in poliammide, colori assortiti*

12  
u.m.vta

12  
box

S

REF. 01914

M

REF. 01086

L

REF. 01087

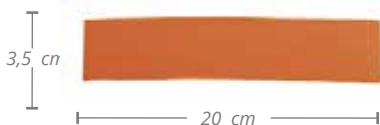

**Karton 12 Haargummis mit Haken**  
Confezione 12 elastici con gancio

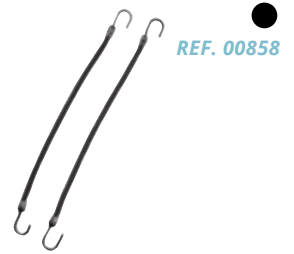

 1 u.m.vta  
40 box
**Karton 24 Haargummis, Schwanz**  
Confezione 24 elastici, per coda

 1 u.m.vta  
60 box
**Karton 24 große Haargummis**  
Confezione 24 elastici grandi



 1 u.m.vta  
60 box

 » Polyamid  
» Poliammide

  
REF. 00812
**Karton 24 kleine Haargummis**  
Confezione 24 elastici piccoli



 1 u.m.vta  
100 box

 » Polyamid  
» Poliammide
**Beutel 12 Mini-Haargummis**  
Busta da 12 mini elastici

 12 u.m.vta  
96 box
**Beutel 10 Haargummis gerippt**  
Busta da 10 elastici

 12 u.m.vta  
96 box



**Pack 2 Spiral Haargummi**  
Confezione da 2 elastici a spirale12  
u.m.Vta12  
box

REF. 04840/50



REF. 04840/69



REF. 04840/56



Ø55



REF. 04807/50



REF. 04807/69



REF. 04807/56



Ø45



REF. 04806/50



REF. 04806/69



REF. 04806/56



Ø35



**Karton 24 farbige geflochtene Haargummis**  
Confezione da 24 elastici intrecciati colorati1  
u.m.vta 16  
box

REF. 02261

**Karton 24 schwarze geflochtene Haargummis**  
Confezione da 24 elastici intrecciati neri1  
u.m.vta 16  
box

REF. 02261/50

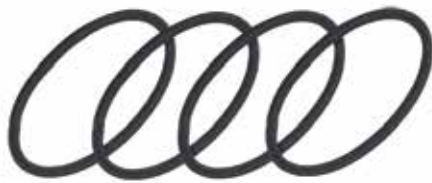
**Karton 48 schwarze gefütterte Haargummis**  
Confezione da 48 elastici chiusi neri1  
u.m.vta 24  
box

Ø5 cm

REF. 03486

**Beutel 5 Silikon Haargummis**  
Busta da 5 elastici in silicone1  
u.m.vta 100  
box

REF. 03467/50

REF. 03467/69

REF. 03467/99

**Beutel mit 50 TPU-Gummiringen für Frisuren**  
**Busta da 50 elastici per acconciature in TPU**

- » Nicht abrasiv
- » Sehr widerstandsfähig
- » Nicht-toxisch
- » Ideal zum Flechten und Stecken

REF. 06808

REF. 06809

REF. 06810

REF. 06811

- » Non abrasivi
- » Molto resistenti
- » Non tossici
- » Ideali per trecce e chignon

**Beutel mit 2000 elastischem Gummiringen**  
**Busta da 2000 elastici**

- » 100 gr. Ca.
- » 100 gr. ca.

REF. 03397

**Anti-Laus Haargummi**  
**Elastico anti pidocchi**

- » Versetzt mit Pilgrim, einer Komponente, die wirksam und dauerhaft Läuse und andere Insekten abwehrt
- » Nachweislich 99% wirksam gegen Läuse
- » Anti-allergisch und geruchlos
- » Weicher Stoff
- » Wir gewährleisten 100 Wäschen, ohne ihre Wirksamkeit zu verlieren



REF. 04717



REF. 04718

- » Formulato con permetrina, un componente efficace e di lunga durata per respingere i pidocchi e altri insetti
- » Comprovata efficacia contro i pidocchi al 99%
- » Antiallergico e inodore
- » Tessuto morbido
- » Garantiamo 100 lavaggi senza perdere l'efficacia



REF. 04719



REF. 04928

## Dekorierter Turban

### Turbante decorato

1  
u.m.vta

10  
box

Eleganz, Glamour und Komfort vereinen sich in unserer Linie nahtlos bestickter Turbane, die vollständig in Spanien entworfen und hergestellt werden. Verschiedene Farben, um sie bei jeder Gelegenheit zu tragen. Eine ideale Ergänzung für die modernste Frau. 6 Modelle verfügbar. 100% Polyester.

*Eleganza, glamour e comfort si uniscono nella nostra linea di turbanti ricamati senza cuciture, progettati e prodotti interamente in Spagna. Colori vari per indossarli in ogni occasione. Un complemento ideale per la donna moderna. 6 modelli disponibili. 100% poliestere.*

» Schwarz  
» Nero

REF. 06055/50



» Blau  
» Blu

REF. 06055/59



» Grün  
» Verde

REF. 06055/62



» Beige  
» Beige

REF. 06055/65



» Rosa  
» Rosa

REF. 06055/70



» Grau  
» Grigio

REF. 06055/72



» Granat  
» Granata

REF. 06055/73



1  
u.m.vta

100  
box

## Beutel 6 bunt dekorierter Turbane

### Busta di 6 turbanti decorati colorati

REF. 06055/99



EUROsil



# Turbantes decorados

www.eurosil.com

**Haarnadeln mit Perlen 2 Stk.**  
Fermagli con perle 2 unità

REF. 06937



REF. 06930



REF. 06932



REF. 06933



REF. 06934



REF. 06935



REF. 06936



REF. 06938

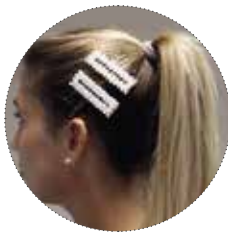

**Rechteckige Perlenklemme 2 Stck.**  
Fermagli rettangolari con perle 2 unità

REF. 06939

**Haarnadel mit weissen facettierten Glaskugeln 2 Stk.**  
Fermagli con sfere di cristallo bianco sfaccettato 2 unità.

REF. 06931

**Haarnadeln Goldfarben mit Strasssteinen 2 Stck.**  
Fermagli con strass 2 unità

REF. 06928



REF. 06929

**Stirnband mit großen Perlen 2 Stk.**  
Cerchietto con perle grandi 2 unità

REF. 06940

**Haarspange mit Perlen 2 Stk.**  
Fermaglio con perle 2 unità

REF. 06941



05

# Papier

CARTA

*Handtücher, Ringlets,  
Halspapier...*

*Salivette, carta permanente,  
carta da collo...*



### Packung mit 75 Handtüchern CELLULOSE Confezione da 75 salviette CELLULOSA

- » Speziell Maniküre
- » Speciale per manicure

50 gr/m<sup>2</sup>

REF. 04204

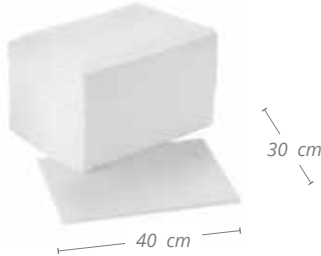

### Packung mit 90 Handtüchern CELLULOSE Confezione da 90 salviette CELLULOSA

55 gr/m<sup>2</sup>

REF. 04076



### Packung mit 25 SPUNLACE Handtüchern Confezione da 25 salviette SPUNLACE

- » Gefaltet auf 20 x 20 cm
- » 50% Polyester / 50% Viskose

- » Piegata 20 x 20 cm
- » 50% poliestere / 50% viscosa

50 gr/m<sup>2</sup>

40 x 90 cm

REF. 04916

50 gr/m<sup>2</sup>

40 x 80 cm

REF. 03221



### Packung mit 100 Handtüchern SPUNLACE Confezione da 100 salviette SPUNLACE

- » Superabsorbierend
- » Ultra assorbenti



REF. 03283

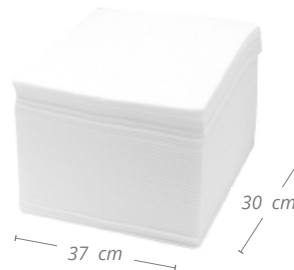

### Beutel 100 Handtücher SPUNLACE Confezione da 100 salviette SPUNLACE

- » Zusammensetzung: 50% Viskose / 50% Polyester
- » Von hoher Widerstandskraft und Absorptionsfähigkeit, vielseitig, praktisch und Einweg.
- » Komplet latexfrei, extra weich im Griff
- » Superabsorbierend
- » Composizione 50% viscosa / 50% Poliestere
- » Altamente resistente e assorbente, versatile, pratico e usa e getta.
- » Completamente privo di lattice, extra morbido al tatto
- » Ultra assorbenti

50 gr/m<sup>2</sup>

REF. 07301



NEW

### Beutel 35 Handtücher SPUNLACE Confezione da 35 salviette SPUNLACE

- » Superabsorbierend
- » Gefaltete Handtücher

- » Ultra assorbenti
- » Salviette piegate

50 gr/m<sup>2</sup>

REF. 04509

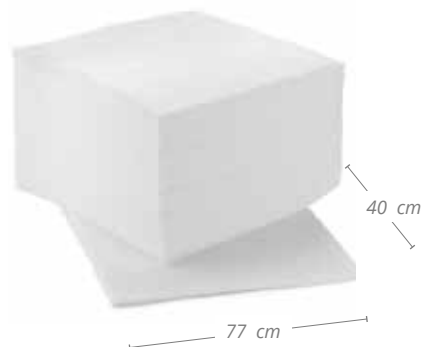



**Supergroßes Dauerwellen Papier**  
**Carta permanente ultra grande**

REF.01230

- » Spender-Box 1000 Blatt
- » Superstark. Absorbierend und porös

» Dispenser box, 1000 fogli  
» Extra forte, assorbente e poroso

**Dauerwellen Papier**  
**Carta permanente**

REF.01136

- » Spenderbox 500 Blatt
- » Dispenser 500 fogli

**Perforiertes Dauerwellenpapier**  
**Carta permanente perforata**

REF.04430

- » Schachtel 1000 Blatt Papier
- » Confezione da 1000 fogli

**Dauerwellen Papier**  
**Carta permanente**

REF.00667

- » Schachtel 1000 Blatt
- » Confezione da 1000 fogli

**POLLIE-Spender**  
**Dispenser POLLIE**

REF. 00802

- » Spender 20 Einheiten x 200 Blatt POLLIE-Ringlet-Papier

» Dispenser 20 confezioni x 200 fogli di carta POLLIE ringlet

**RINGLETS-Spender**  
**Dispenser RINGLET**

REF. 00656

- » Spender 20 Einheiten x 200 Blatt Ringletpapier

» Dispenser 20 libretti x 200 fogli di carta ringlet



### Armband Ringlet Papier Polsino per carta ringlet



REF.00657/50



REF.00657

### Rolle Kreppansatzpapier für den Hals 100 Stück Rotolo di carta da collo adesiva, 100 servizi



REF. 00681

- » Blauer Klebstoff für einfaches Kleben und Platzieren
- » Hochwertige Qualität
- » Schnelle und perfekte Passform
- » Hygienischer Einmalgebrauch
- » Einwegpapier
- » Elastisch und anpassbar an jeden Hals
- » Entwickelt für professionelle Friseure und Barbieri
- » Verhindert Juckreiz und Brennen am Hals

- » *Adesivo blu per facile fissaggio e posizionamento*
- » *Qualità premium*
- » *Fissaggio perfetto e veloce*
- » *Monouso e igienico*
- » *Carta usa e getta*
- » *Elastico regolabile a ogni collo*
- » *Progettato per parrucchieri e barbieri professionisti*
- » *Evita il prurito e il bruciore al collo*



### Papierrollenhalter Portarotolo per carta da collo

- » Halter für Kreppansatzpapier  
00681, 04651, 06596, 06927
- » Portarotolo per carta da collo  
00681, 04651, 06596, 06927



REF. 00800

- » Material: abs schwarz
- » Kann an der wand aufgehängt werden
- » Materiale: abs nero
- » Può essere appeso alla parete



REF. 06803



06

# Ausbildung

FORMAZIONE

*Traingsköpfe, Stative,  
Tischhalterung...*

*Teste studio, treppiedi, supporti da  
tavolo con morsetto ...*



### Schaufensterpuppen-Kopf, 100% NATURHAAR

#### Teste studio CAPELLI 100% NATURALI

Mit Halterung  
Con supporto incluso



- » 42 Implantate pro cm<sup>2</sup>
- » 6-7 Haare pro Implantat
- » ca. 260 Haare pro cm<sup>2</sup>
- » Zum Schneiden, Bleichen, Färben, Dauerwellen, Styling, Steckfrisuren, Trocknen und Glätten
- » Maximale Temperatur 180°C
- » Klassisches 90°-Implantat

- » 42 impianti per cm<sup>2</sup>
- » 6-7 capelli per impianto
- » 260 capelli circa per cm<sup>2</sup>
- » Per tagliare, decolorare, tingere, permanente, acconciature, asciugatura e piastra
- » Temperatura massima 180°C
- » Impianto classico 90°

### Kastanie · Castano



REF. 01455



REF. 00624



REF. 00603



REF. 01142

### Sehr hellblond · Biondo molto chiaro

- » Nicht bleichen
- » Non decolorare



REF. 04251

- » Ohne Wimpern
- » Bleichen
- » Senza ciglia
- » Non decolorare



REF. 04586

**Schaufensterpuppen-Kopf, 100% NATURHAAR**  
**Testa studio, 100% CAPELLI NATURALI**

 Halterung nicht inbegriffen  
 Supporto non incluso

- » 42 Implantate pro cm<sup>2</sup>
- » 6-7 Haare pro Implantat
- » ca. 260 Haare pro cm<sup>2</sup>
- » Zum Schneiden, Bleichen, Färben, Dauerwellen, Styling, Steckfrisuren, Trocknen und Glätten
- » Maximale Temperatur 180°C
- » Klassisches 90°-Implantat

- » 42 impianti per cm<sup>2</sup>
- » 7-8 capelli per impianto
- » 320 capelli circa per cm<sup>2</sup>
- » Per tagliare, decolorare, tingere, acconciare, asciugatura e piastra
- » Temperatura massima 180°C

**Hellbraun · Castano chiaro**

» Klassisches Implantat

 » *Impianto classico*

35 - 40 cm

Ø 50

**Leia**
**REF. 06642**

» Natürliche Implantate

 » *Impianto naturale*

35 - 40 cm

Ø 50

**Amber**
**REF. 06643**

» Natürliche Implantate

 » *Impianto naturale*

45 - 50 cm

Ø 50

**Jenny**
**REF. 06644**

» Natürliche Implantate

 » *Impianto naturale*

55 - 60 cm

Ø 50

**Daisy**
**REF. 06645**

» Natürliche Implantate 45°

 » *45° impianto naturale*

20 - 30 cm

Ø 54

**Lucy**
**REF. 06149**

» Klassisches Implantat 90°

 » *90° Impianto classico*

20 - 30 cm

Ø 54

**Lucy**
**REF. 04910**

**Kastanienbrauner Schaufensterpuppen-Kopf,****100% NATURHAAR****Testa studio castano, CAPELLI 100% NATURALI**Halterung nicht inbegriffen  
Supporto non incluso

- » Natürliches Implantat 45°.
- » Mit Wimpern
- » 42 Implantate pro cm<sup>2</sup>
- » 6-7 Haare pro Implantat
- » ca. 260 Haare . pro cm<sup>2</sup>
- » Zum Schneiden, Bleichen, Färben, Dauerwellen, Styling, Steckfrisuren, Trocknen und Glätten
- » Maximale Temperatur 180°C

- » Impianto naturale 45°
- » Con ciglia
- » 42 impianti per cm<sup>2</sup>
- » 6-7 capelli per impianto
- » 260 capelli circa per cm<sup>2</sup>
- » Per tagliare, decolorare, tingere, permanente, acconciature, asciugatura e piastra
- » Temperatura massima 180°C

**Kastanienbraun Dunkel · Castano scuro****Emily**

REF. 04905



35 - 40 cm

Ø 54



45 - 50 cm

Ø 54

**Lisa**

REF. 04906



55 - 60 cm

Ø 54

**Rose**

REF. 04907

**Schaufensterpuppen-Kopf, 100% NATURHAAR**  
**Testa studio, CAPELLI 100% NATURALI**

 Halterung nicht inbegriffen  
 Supporto non incluso

- » Mit Wimpern
- » Natürliche Implantate 45°
- » 42 Implantate pro cm<sup>2</sup>
- » 6-7 Haare pro Implantat
- » ca 260 Haare . pro cm<sup>2</sup>
- » Zum Schneiden, Bleichen, Färben, Dauerwellen, Styling, Steckfrisuren, Trocknen und Glätten
- » Maximale Temperatur 180°C

- » Con ciglia
- » Impianto naturale 45°
- » 42 impianti per cm<sup>2</sup>
- » 6-7 capelli per impianto
- » 260 capelli circa per cm<sup>2</sup>
- » Per tagliare, decolorare, tingere, permanente, acconciature, asciugatura e piastra
- » Temperatura massima 180°C

**Schwarz · Nero**

- » Remy Haar
- » Capelli remy



40 - 45 cm

Ø 54

**Chloe**

REF. 04904

**Sehr hellblond · Biondo molto chiaro**

- » Nicht bleichen
- » Natürliche Implantate 45°
- » Non decolorare
- » Impianto naturale 45°



45 - 50 cm

Ø 54

**Sophie**

REF. 04903

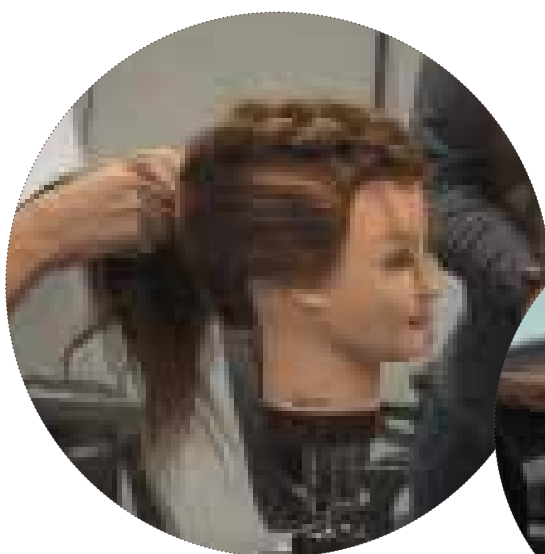

### Männliche Schaufensterpuppe, 100% Naturhaar Testa studio uomo, CAPELLI 100% NATURALI

Mit Halterung  
Con supporto incluso



- » 42 Implantate pro cm<sup>2</sup>
- » 7-8 Haare pro Implantat
- » ca. 320 Haare pro cm<sup>2</sup>
- » Zum Schneiden, Bleichen, Färben, Stylen, Trocknen und Glätten
- » Maximale Temperatur 180°C

- » 42 impianti per cm<sup>2</sup>
- » 7-8 capelli per impianto
- » 320 capelli circa per cm<sup>2</sup>
- » Per tagliare, decolorare, tingere, acconciare, asciugatura e piastra
- » Temperatura massima 180°C

#### Kastanienbraun · Castano

- » Natürliche Implantate 45°

» Impianto naturale 45°



15 - 18 cm

Ø 58

REF. 02495

#### Kastanienbraun mit Bart · Castano con barba

- » Natürliche Implantate 45°
- » Auch zum Bartschneiden

» Impianto naturale 45°  
» Anche per taglio della barba



15 - 18 cm

Ø 58

REF. 02169

Halterung nicht inbegriffen  
Supporto non incluso

#### Kastanienbraun hell JOE · Castano chiaro JOE

- » Natürliche Implantate 45°

» Impianto naturale 45°



15 - 18 cm

Ø 54

REF. 06147

- » Klassisches Implantat 90°

» Impianto classico 90°



15 - 18 cm

Ø 54

REF. 04909

#### Kastanienbraun hell mit Bart DANIEL · Castano chiaro con barba DANIEL

- » Natürliche Implantate 45°

» Impianto naturale 45°



15 - 18 cm

Ø 54

REF. 06148

- » Klassisches Implantat 90°

» Impianto classico 90°



15 - 18 cm

Ø 54

REF. 04908



**Schaufensterpuppen-Kopf, 100% SYNTHETISCHES HAAR**  
**Testa studio, CAPELLI 100% SINTETICI**

Halterung nicht inbegriffen  
 Supporto non incluso



- » Natürliches Implantat 45°.
- » 42 Implantate pro cm<sup>2</sup>
- » 5-6 Haare pro Implantat
- » ca. 210 Haare pro cm<sup>2</sup>
- » Zum Schneiden, Kämmen, Steckfrisuren, Trocknen und Glätten
- » Maximale Temperatur 180°C Bleichen, Färben oder Dauerwelle nicht möglich

- » *Impianto naturale 45°*
- » *42 impianti per cm<sup>2</sup>*
- » *5-6 capelli per impianto*
- » *210 capelli circa per cm<sup>2</sup>*
- » *Per tagliare, acconciare, asciugatura e piastra*
- » *Temperatura massima 180°C*
- » *Non adatto a decolorare, tinta o permanente*

**Blond · Biondo**



35 - 40 cm

REF. 04954

Ø 54



45 - 50 cm

REF. 04955

Ø 54



55 - 60 cm

REF. 04956

Ø 54

**Schaufensterpuppen-Kopf, 100% PRO-H SYNTHETISCHES HAAR**  
**Testa studio, CAPELLI SINTETICI 100% PRO-H**

Mit Halterung  
 Con supporto incluso



- » Zum Schneiden, Färben, Steckfrisuren, Trocknen und Glätten
- » Maximale Temperatur 140°C
- » Nicht färben
- » 42 Implantate pro cm<sup>2</sup>
- » 6-7 Haare pro Implantat
- » ca. 260 Haare pro cm<sup>2</sup>
- » Klassisches Implantat 90°
- » Geeignet zum Färben und dauerhaft

- » Per tagliare, tingere, acconciare, asciugatura e piastra
- » Temperatura massima 140°C
- » Non decolorare
- » 42 impianti per cm<sup>2</sup>
- » 6-7 capelli per impianto
- » 260 peli circa per cm<sup>2</sup>
- » Impianto classico 90°C
- » Adatto per tinture e permanenti

**Hellblond · Biondo chiaro**



Ø 50

REF. 02543

10 - 40 cm



Ø 50

REF. 02545

55 - 60 cm



FARBSTOFFE UND DAUERWELLE  
 TINTA E PERMANENTE



MAX 140°



Ø 50

REF. 02544

45 - 50 cm

# BERGMANN

HAIR AND MORE...

## Schaufensterpuppen-Kopf, 100% NATURHAAR Testa studio, CAPELLI 100% NATURALI

Halterung nicht inbegriffen  
Supporto non incluso



### Hellblond · Biondo chiaro

- » Natürliches Implantat
- » Für Schneiden, Styling, Dauerwelle und Färben

- » *Impianto naturale*
- » *Per tagliare, acconciare, permanente e colore*



Ø 53

30 - 35 cm  
aprox.

### Junior

REF. 06342

### Blond · Biondo

- » Natürliches Implantat
- » Zum Schneiden und Färben

- » *Impianto naturale*
- » *Per tagliare e tingere*



30 - 35 cm  
aprox.

### Teeny

REF. 06344

### Kastanie · Castano

- » Natürliches Implantat
- » Zum Schneiden und Färben

- » *Impianto naturale*
- » *Per tagliare e tingere*



30 - 35 cm  
aprox.

### Teeny

REF. 06345

### Boy

REF. 06341



20 cm  
aprox.

Ø 56

### Halterung für Trainingsköpfe Supporti per teste studio

» Kunststoff  
» Plastica



1 u.m.vta  
25 box

REF. 00983

» Kunststoff  
» Plastica



1 u.m.vta  
25 box

REF. 01461

» Kunststoff  
» Plastica



1 u.m.vta  
10 box

REF. 06276

» Kunststoff  
» Plastica



1 u.m.vta  
10 box

REF. 06162

» Aluminium  
» Alluminio



1 u.m.vta  
12 box

REF. 03625

### Stativ Halterung für Trainingsköpfe Supporti a treppiede per teste studio

» Aluminium  
» Alluminio

1 u.m.vta  
10 box

REF. 03738

» Aluminium  
» Alluminio

1 u.m.vta  
6 box

REF. 03624

» Aluminium  
» Alluminio

1 u.m.vta  
6 box

REF. 01841



166 - 81 cm



133 - 65 cm



126 - 78 cm

07

# Möbel

COMPLEMENTI D'ARREDO

*Bedienplatz, Friseurtühle,  
Kopfwaschanlagen, Regale, Arbeitswagen...*

*Poltrone, lavaggio, mensole, carrelli...*



### Empfangstheke aus Holz und Metall mit Spiegeleffekt Bancone reception in legno e metallo a effetto specchio

Mit Innenfächern aus Holz zur Aufbewahrung und Ablage  
Con scomparti interni in legno



REF.03935



### Empfang EARTH Eiche Reception EARTH rovere

- » Graphit-Laminat
- » Mit verstellbaren Einlegeböden und 1 Schublade

- » Laminato in grafite
- » Con ripiani regolabili e 1 cassetto

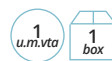

REF.04518/50

REF.04518/65



REF.04518/58

REF.04518/72

**Bedienplatz Doppelt mit Spiegel**  
**Specchio doppio**

- » Mit Schrank, Tisch und Fußstütze
- » Con armadio, mensola e poggiatesta



REF.03949

**Sofa mit 3 Sitzplätzen**  
**Divano attesa 3 posti**

- » In Kunstleder
- » In similpelle



REF.03950

**Bedienplatz MERCURY**  
**Mobile con specchio a parete MERCURY**

Graphit · Grafite ●  
REF.04517/50

Weiß · Bianca ○  
REF.04517/58

Eiche · Rovere ●  
REF.04517/65

Grau · Grigio ●  
REF.04517/72



- » Graphit-Laminat
- » Mit Ablage, mit Föhn-Halterung und eingebauter verchromter Fußstütze

- » Laminato in grafite
- » Con mensola, porta-asciugacapelli e poggiatesta integrato cromato

**Rechteckiger Spiegel LIGHT**  
**Specchio rettangolare LIGHT**

REF.06099



- Rechteckiger Unisex-Spiegel, elegant und raffiniert. Enthält eine große Spiegelfläche. Enthält ein Regal zur Ablage der gewünschten Objekte sowie eine bequeme Fußstütze.

- Specchio rettangolare, elegante e sofisticato. Include un ripiano per appoggiare oggetti, oltre a un comodo poggiatesta..



## Stühle für Kinder Poltrone per bambini

Hochwertige Kinderstühle, aus Metall und im Vintage-Stil das Kindern die Erfahrung des Friseurbesuchs angenehm machen soll. Tretautos, die funktionieren, wenn sie aus der Halterung entfernt werden. Dekorative Lichter und Sicherheitsgurt. Wenn Sie das Lenkrad drehen, bewegen sich auch die Vorderräder. Keine Hupe vorhanden.

Poltrone per bambini di alta qualità, realizzate in metallo e con uno stile vintage per rendere piacevole l'esperienza di andare dal parrucchiere ai bambini. Auto a pedali che funzionano se rimosse dal piedistallo. Luci decorative e cintura di sicurezza. Inoltre, se si gira il volante, le ruote anteriori si muovono. Senza clacson.



24 kg

REF.04728



26,8 kg

REF.04727





### Spezialstuhl für Kinder Poltrona speciale per bambini



REF.02733



54-79 cm

### Kissen speziell für Kinder Cuscini speciali per bambini



Spezielle Kissen, die für jeden Friseurstuhl geeignet sind. Sie ermöglichen dem Fachmann ein bequemerer Arbeiten, da sie das Kind auf die ideale Höhe bringen.

*Cuscini speciali adatti a qualsiasi poltrona da parrucchiere. Consentono un lavoro più confortevole per il professionista, poiché sollevano il bambino all'altezza ideale.*



REF.04506/50



REF.04506/58



REF.04506/59



REF.04506/60

### Kissen speziell für Kinder Cuscini speciali per bambini



REF.07329/50



NEW

### Kissen speziell für Kinder Cuscini speciali per bambini



REF.03939

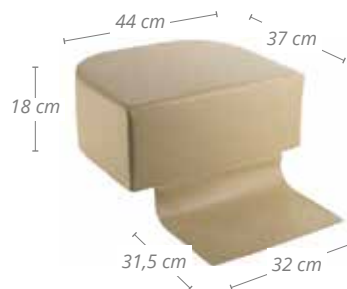

REF.04506/69

### STREET Hocker Sgabello STREET

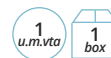

Der Hocker STREET klassisch enthält eine Hydraulikpumpe, mit der die Höhe auf die gewünschte Höhe des Profis eingestellt werden kann, was ihm die Arbeit erleichtert.

*Lo sgabello STREET classico con pompa a gas che permetterà al professionista di regolare l'altezza facilitando il suo lavoro.*



REF.06103/50



REF.06103/58

45-59 cm

45 cm

Vergleich 04419 - 06103  
Comparativa 04419 - 06103



### Hocker mit Metallgestell Sgabello con base in metallo



50-66 cm



REF.04419/50

50-66 cm



REF.04419/58

### SWEET SIT Hocker Sgabello SWEET SIT



61-71 cm



REF.01328

### RODEO Hocker Sgabello RODEO



58-77 cm



REF.01964

### URBAN Hocker

#### Sgabello URBAN



Ergonomischer Hocker URBAN mit Hydraulikpumpe, um die Höhe bei jeder Arbeit auf die gewünschte Höhe zu regulieren. Seine Form passt sich dem Körper an und begünstigt dadurch eine bessere Körperhaltung und vermeidet Rückenschmerzen nach vielen Arbeitsstunden.

*Sgabello URBAN ergonomico con pompa a gas, per regolare l'altezza a quella desiderata per ogni lavoro. La sua forma si adatta al corpo e di conseguenza favorisce una migliore postura e previene il mal di schiena dopo molte ore di lavoro.*



REF.06102/50



REF.06102/58

Vergleich 04382 - 06102  
Comparativa 04382 - 06102



### RODEO Hocker Metallfuß

#### Sgabello RODEO con base in metallo



REF.04382/50



REF.04382/58

### Fußstütze

#### Poggiapiedi



REF.04384

REF.04385

REF.02838



Gerade Metall-Fußstütze  
Poggiapiedi dritto in metallo



Gebogene Metall-Fußstütze  
Poggiapiedi curvo in metallo



### Stuhl mit Rückenlehne und Regulierung

#### Poltrona regolabile con schienale



REF.02730/50

REF.02730/58

REF.02730/54

### Verstellbarer Stuhl

#### Poltrona regolabile



REF.02732

REF.02732/58

### Stuhl mit Rückenlehne und Regulierung

#### Poltrona regolabile con schienale

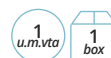

REF.03937/50

REF.03937/58

### FASHION Stuhl mit Rückenlehne

#### Poltrona con schienale FASHION



FASHION Stuhl mit Rückenlehne für mehr Komfort und Rückenunterstützung. Die Räder sind so konstruiert, dass sich die Haare nicht darin verfangen können. Sie sind leicht zu reinigen.

Poltrona FASHION con schienale per un maggiore comfort e sostegno per la schiena. Le ruote sono progettate per evitare che i capelli vi rimangano impigliati, facili da pulire.



REF.06101/58

### Kopfwaschanlage GLAMOUR Poltrona lavatesta GLAMOUR

1 u.m.vta  
1 box

Neuen Friseurstuhls GLAMOUR. Geradliniges und modernes Design, aber mit maximalem Komfort. Höhenverstellbar Dank seiner Hydraulikpumpe.

REF.07191

*Nuova poltrona lavatesta per parrucchieri/barbieri GLAMOUR. Design lineare e moderno, con la massima comodità. Vasca basculante in ceramica, ergonomica.*

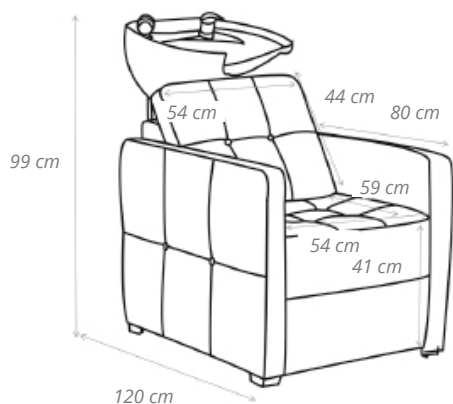

NEW

### Kopfwaschanlage KURVA Poltrona lavatesta KURVA

1 u.m.vta  
1 box

Neuen Friseurstuhls KURVA. Geradliniges und modernes Design, aber mit maximalem Komfort. Ausgestattet mit einem ergonomischen und neigbarem Keramikbecken.

REF.07193

*Nuova poltrona lavatesta per parrucchieri/barbieri KURVA. Design lineare e moderno, con la massima comodità. Vasca basculante in ceramica, ergonomica.*

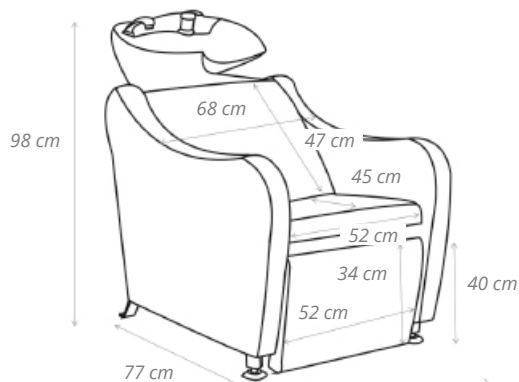

NEW

### Kopfwaschanlage OVAL Poltrona lavatesta OVAL

1 u.m.vta  
1 box

Neuen Friseurstuhls OVAL. Geradliniges und modernes Design, aber mit maximalem Komfort. Ausgestattet mit einem ergonomischen und neigbarem Keramikbecken.

REF.07195

*Nuova poltrona lavatesta per parrucchieri/barbieri OVAL. Design lineare e moderno, con la massima comodità. Vasca basculante in ceramica, ergonomica.*

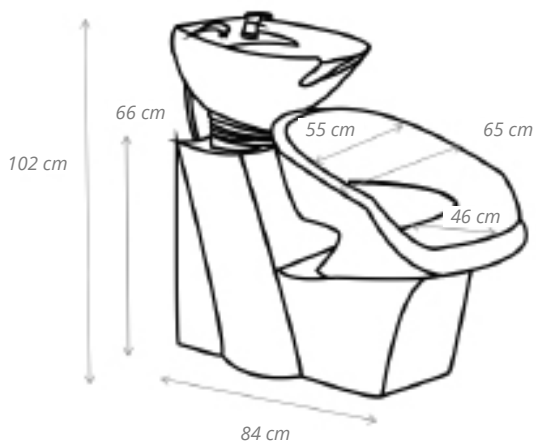

NEW

### Kopfwaschanlage KVADRAT Poltrona lavatesta KVADRAT

1 u.m.vta  
1 box

Neuen Friseurstuhls KVADRAT. Geradliniges und modernes Design, aber mit maximalem Komfort. Höhenverstellbar Dank seiner Hydraulikpumpe.

REF.07197

*Nuova poltrona lavatesta per parrucchieri/barbieri KVADRAT. Design lineare e moderno, con la massima comodità. Vasca basculante in ceramica, ergonomica.*

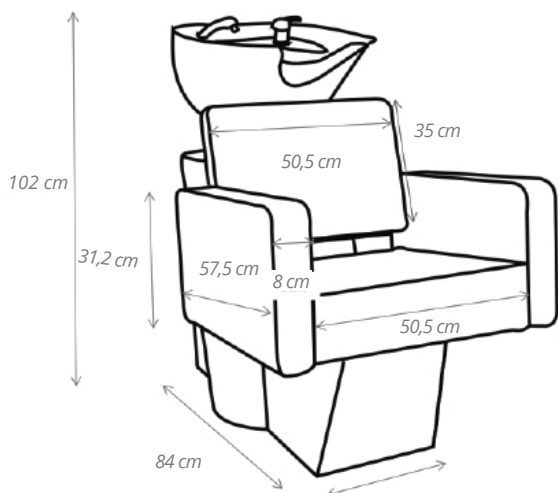

NEW

**Kopfwaschanlage PIN UP**  
**Poltrona lavatesta PIN UP**

Aufgrund der Schaumstoffpolsterung können die Maße eine kleine Abweichung von etwa 1 cm aufweisen.

REF.06476/70

*A causa della schiuma nell'imbottitura, le misure possono subire una leggera variazione di circa 1 cm.*

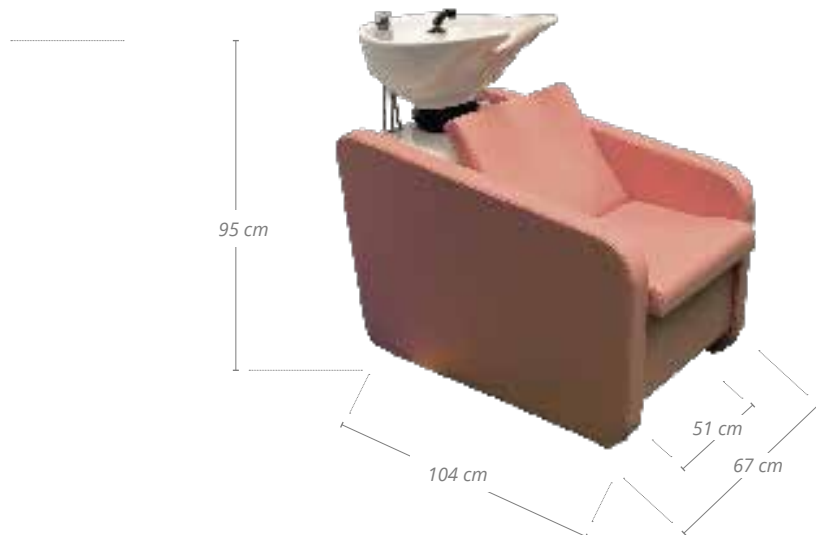
**Kopfwaschanlage STIL**  
**Poltrona lavatesta STIL**

- » Armlehnen und Bedienelemente aus Chrom
- » Keramikfliese und Glasfasersockel
- » Schiebesitz
- » Basislänge 76 cm
- » Sitzbreite 48 cm
- » Höhe der Rückenlehne 41 cm
- » Keramikbecken 57 x 50 x 20 cm
- » Gesamthöhe 95 cm

- » Braccioni e rubinetto cromati
- » Lavello in ceramica e base in fibra di vetro
- » Sedile scorrevole
- » Lunghezza base 76 cm
- » Larghezza sedile 48 cm
- » Altezza schienale 41 cm
- » Lavabo in ceramica 57 x 50 x 20 cm
- » Altezza totale 95 cm



REF. 02841



REF. 02841/54



REF. 02841/58

### Kopfwaschanlage NEPTUNO Poltrona lavatesta NETTUNO

1 u.m.vta 1 box

- » Stahl- und Holzkonstruktion
- » Weißes kippbares Keramikbecken
- » Fester Sitz
- » Einhebelmischer mit schwarzer Handbrause

- » *Struttura in acciaio e legno*
- » *Vasca basculante in ceramica bianca*
- » *Sedile fisso*
- » *Miscelatore doccia nero*



		
REF.04516/50	REF.04516/58	REF.04516/60
		
REF.04516/62	REF.04516/64	REF.04516/65
		
REF.04516/68	REF.04516/69	REF.04516/72









### Kopfwaschanlage VENUS Poltrona lavatesta VENUS

1 u.m.vta 1 box

- » Struktur aus Polyethylen
- » Weißes kippbares Keramikbecken
- » Fester Sitz
- » Einhebelmischer mit schwarzer Handbrause

- » *Struttura in polietilene*
- » *Vasca basculante in ceramica bianca*
- » *Sedile fisso*
- » *Miscelatore doccia nero*



		
REF.04514/50	REF.04514/58	REF.04514/60
		
REF.04514/62	REF.04514/64	REF.04514/65
		
REF.04514/68	REF.04514/69	REF.04514/72

### Kopfwaschanlage VENUS--Trennwand schwarz Separatore lavatesta VENUS nero

1 u.m.vta 1 box



REF.04515



## Kopfwaschanlage ART Poltrona lavatesta ART

1  
u.m.vta

1  
box

Die neue ART-Kopfwaschanlage hat ein Design mit geschwungenen Linien, in den Ausführungen Schwarz und Silber, das dem Kunden maximalen Komfort beim Haarewaschen bietet. Sie besteht aus einem tiefen, ergonomisch geformten Keramikbecken, der sich im Beinbereich verstellen und an jeden Service anpassen lässt. Zusammen mit dem ART-Stuhl bilden sie das ideale Set für Ihren Salon.

*La nuova poltrona lavatesta ART ha un design dalle linee curve, di colore nero e con finiture argento, pensato per offrire il massimo comfort al cliente durante il lavaggio dei capelli. E' composta da un lavabo in ceramica profondo, ergonomico, reclinabile nella zona dei piedi.*

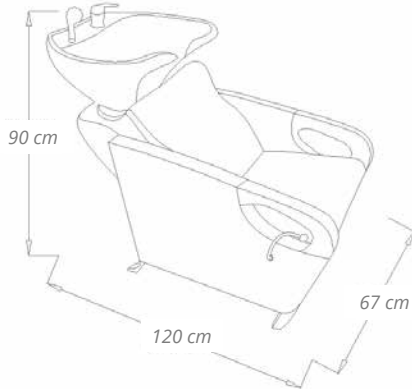

REF.06097/50



Verstellbar  
Reclinabile



## Kopfwaschanlage MOOD

### Poltrona lavatesta MOOD

1  
u.m.vta

1  
box

Die neue MOOD-Kopfwaschanlagen hat ein Design mit geschwungenen Linien, das dem Kunden maximalen Komfort beim Haarewaschen bieten soll. Sie besteht aus einem tiefen, ergonomisch geformten Keramikbecken, der im Beinbereich verstellbar und an jeden Dienst angepasst werden kann.

*La nuova poltrona lavatesta MOOD ha un design dalle linee curve pensato per offrire il massimo comfort al cliente durante il lavaggio dei capelli. È composta da un lavello in ceramica profondo, ergonomico, reclinabile nella zona dei piedi e adattabile a ogni servizio.*



### Friseurstuhl GLAMOUR

#### Poltrona da parrucchiere GLAMOUR

1  
u.m.vta

1  
box

REF.07190

Vielen Dank für den Kauf unseres neuen Friseurstuhls GLAMOUR. Geradliniges und modernes Design, aber mit maximalem Komfort. Höhenverstellbar Dank seiner Hydraulikpumpe.

NEW

Nuova poltrona per parrucchieri/barbieri GLAMOUR. Design lineare e moderno, con la massima comodità. Altezza regolabile.

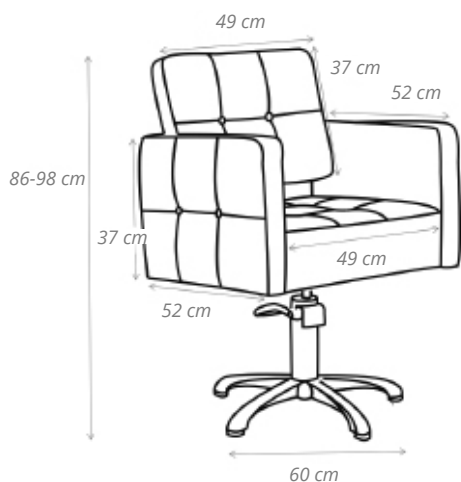

### Friseurstuhl KURVA

#### Poltrona da parrucchiere KURVA

1  
u.m.vta

1  
box

REF.07192

Vielen Dank für den Kauf unseres neuen Friseurstuhls KURVA. Geradliniges und modernes Design, aber mit maximalem Komfort. Höhenverstellbar Dank seiner Hydraulikpumpe.

NEW

Nuova poltrona per parrucchieri/barbieri KURVA. Design lineare e moderno, con la massima comodità. Altezza regolabile.

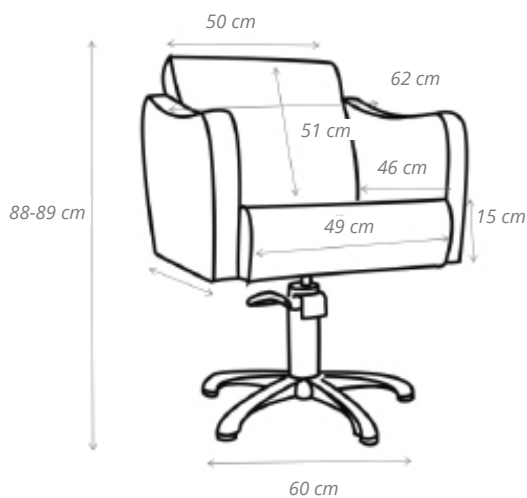

### Friseurstuhl OVAL

#### Poltrona da parrucchiere OVAL

1 u.m.vta  
1 box

REF.07194

Vielen Dank für den Kauf unseres neuen Friseurstuhls OVAL. Geradliniges und modernes Design, aber mit maximalem Komfort. Höhenverstellbar Dank seiner Hydraulikpumpe.

Nuova poltrona per parrucchieri/barbieri OVAL. Design lineare e moderno, con la massima comodità. Altezza regolabile.

NEW

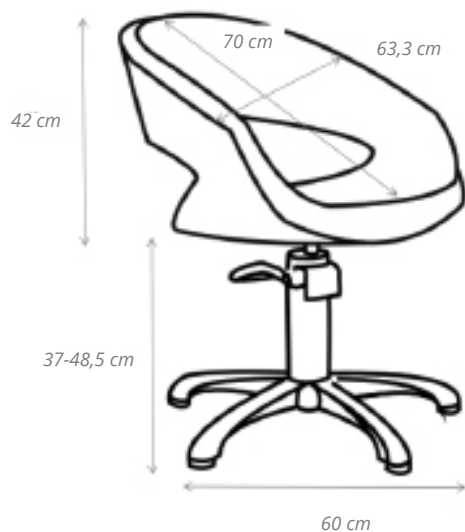

### Friseurstuhl KVADRAT

#### Poltrona da parrucchiere KVADRAT

1 u.m.vta  
1 box

REF.07196

Vielen Dank für den Kauf unseres neuen Friseurstuhls KVADRAT. Geradliniges und modernes Design, aber mit maximalem Komfort. Höhenverstellbar Dank seiner Hydraulikpumpe.

Nuova poltrona per parrucchieri/barbieri KVADRAT Design lineare e moderno, con la massima comodità. Altezza regolabile.

NEW

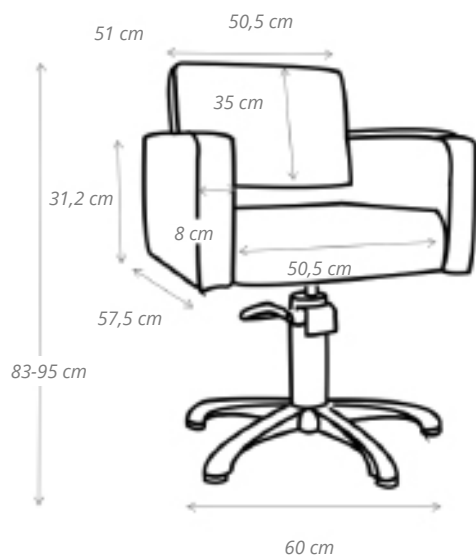

**Friseurstuhl COMFORT****Poltrona da parrucchiere COMFORT**

Der Friseurstuhl COMFORT hat ein Design mit geraden Linien, das für maximalen Komfort sorgt. Der Stuhl verfügt über eine Hydraulikpumpe, mit der Sie den Sitz heben und senken können, so dass Sie den Kunden auf die Höhe bringen können, die für die jeweilige Arbeit am besten geeignet ist.

*La poltrona da parrucchiere COMFORT ha un design dalle linee dritte studiato per offrire il massimo del comfort. Altezza regolabile.*

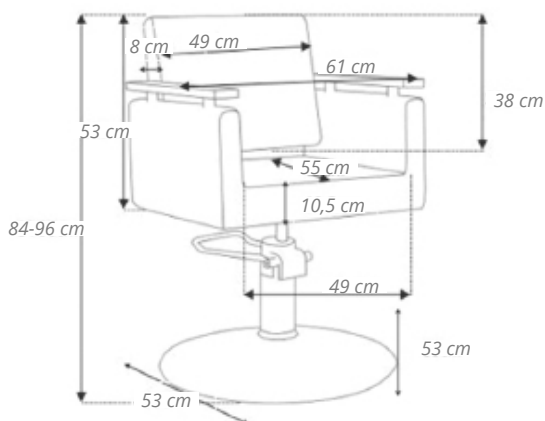

REF.06585

Sternfuß  
Piedistallo a stella

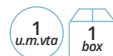
**Friseurstuhl PIN UP ROSE****Poltrona da parrucchiere PIN UP ROSA**

Der neue PIN UP Stuhl hat ein Design mit modernen Linien, die auf maximalen Komfort ausgelegt sind. Der Stuhl verfügt über eine Hydraulikpumpe, mit der der Sitz angehoben und abgesenkt werden kann, so dass Sie den Kunden auf die Höhe bringen können, die für die jeweilige Arbeit am besten geeignet ist.

*La nuova poltrona PIN UP ha un design dalle linee moderne studiato per offrire il massimo del comfort. Altezza regolabile.*

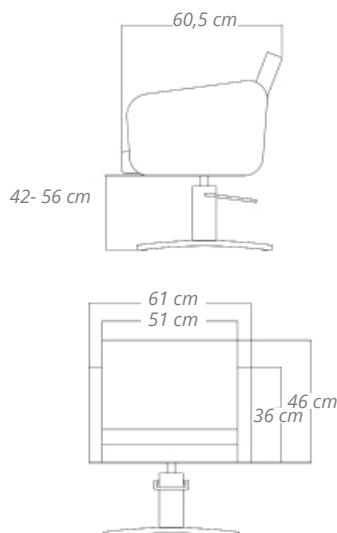

REF.06477/70

### Friseurstuhl STRATOS

#### Poltrona STRATOS

- » Mit Fußstütze
- » Hydraulischer Höhenverstellung
- » Rückenlehne: 52 x 45 cm
- » Breite Armlehne zu Armlehne: 50 cm
- » Sitzbasis: 48 cm
- » Verchromte Armstützen

- » Con poggiatesta
- » Altezza regolabile
- » Schienale: 52 x 45 cm
- » Larghezza da bracciolo a bracciolo: 50 cm
- » Base del sedile: 48 cm
- » Braccioli cromati



REF. 02840



REF. 02840/54



REF. 02840/60



REF. 02840/59

### Hydraulischer Friseurstuhl VENUS SCHWARZ

#### Poltrona VENUS BLACK

- » Unterlage mit Sternemotiven aus Aluminium
- » Hydraulisches Anheben
- » In Schwarz gepolstert
- » Breite: 58 cm
- » Tiefe: 64 cm
- » Hubhöhe Sitz: 45 cm - 60,5 cm

- » Base a stella in alluminio
- » Sollevamento idraulico
- » Rivestimento in nero
- » Larghezza: 58 cm
- » Profondità: 64 cm
- » Altezza di elevazione del sedile: 45 cm - 60,5 cm



REF. 04513/50

REF. 04513/58

REF. 04513/60

REF. 04513/62

REF. 04513/64

REF. 04513/65



REF. 04513/68

REF. 04513/69

REF. 04513/72

### Friseurstuhl CHIC

#### Poltrona da parrucchiere CHIC

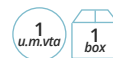

Der Friseurstuhl CHIC hat ein klassisches Design, das gerade und geschwungene Linien kombiniert und für maximalen Komfort sorgt. Der Stuhl verfügt über eine Hydraulikpumpe, mit der der Sitz angehoben und abgesenkt werden kann, so dass der Kunde in der Höhe positioniert werden kann, die für die jeweilige Arbeit am besten geeignet ist. Es kann mit 3 Füßen und mit der Option einer Fußstütze kombiniert werden.

*La poltrona da parrucchiere CHIC ha un design classico che combina linee dritte e curve studiato per offrire il massimo del comfort. Altezza regolabile. Abbinabile a 3 piedistalli e con possibilità di poggipiedi.*

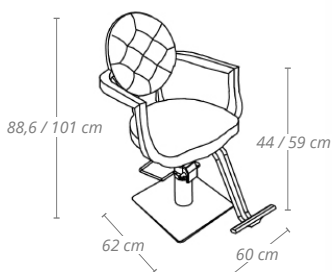

REF.06096/50/2 REF.06096/50/5\*



REF.06096/50/3 REF.06096/50/6\*



REF.06096/50/1 REF.06096/50/4\*



\* Mit Fußstütze  
\*Con poggipiedi

### Friseurstuhl STYLE

#### Poltrona da parrucchiere STYLE



Der Friseurstuhl STYLE hat ein Vintage-Design, das geschwungene Linien in Schwarz und mit weißen Nähten kombiniert, um maximalen Komfort zu bieten. Der Stuhl verfügt über eine Hydraulikpumpe, mit der der Sitz angehoben und abgesenkt werden kann, so dass Sie den Kunden in der Höhe platzieren können, die für die jeweilige Aufgabe am besten geeignet ist. Es kann mit 3 Füßen und mit der Option einer Fußstütze kombiniert werden.

*La poltrona da parrucchiere STYLE ha un design vintage che combina linee curve, in nero e cuciture bianche, pensato per offrire il massimo comfort. Altezza regolabile. Abbinabile a 3 piedistalli e con possibilità di poggipiedi.*

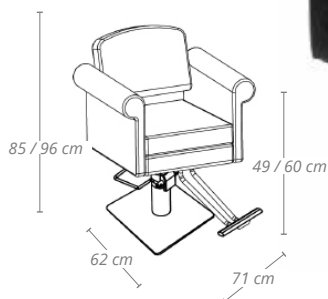

REF.06095/50/2 REF.06095/50/5\*



REF.06095/50/3 REF.06095/50/6\*



REF.06095/50/1 REF.06095/50/4\*



\* Mit Fußstütze  
\*Con poggipiedi

### Friseurstuhl BOHEMIAN

#### Poltrona da parrucchiere BOHEMIAN



Der Friseurstuhl BOHEMIAN hat ein modernes Design, das geschwungene und gerade Linien kombiniert, in Schwarz und mit silbernen Oberflächen, um maximalen Komfort zu bieten. Der Stuhl verfügt über eine Hydraulikpumpe, so dass Sie den Sitz heben und senken und den Kunden auf die Höhe bringen können, die für die jeweilige Arbeit am besten geeignet ist. Es kann mit 3 Füßen und mit der Option einer Fußstütze kombiniert werden.

*La poltrona da parrucchiere BOHEMIAN ha un design contemporaneo che combina linee curve e dritte, in nero e finiture argento, pensato per offrire il massimo comfort. Altezza regolabil. Abbinabile a 3 piedistalli e con possibilità di poggiapiedi.*



REF.06093/50/2 REF.06093/50/5\*



REF.06093/50/3 REF.06093/50/6\*

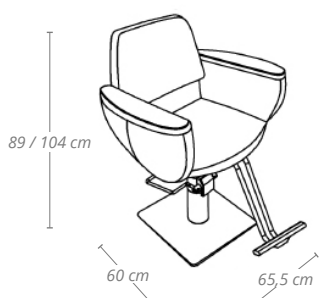

REF.06093/50/1 REF.06093/50/4\*

\* Mit Fußstütze  
\*Con poggiapiedi

### Friseurstuhl ART

#### Poltrona da parrucchiere ART



Der Friseurstuhl ART hat ein modernes Design, das geschwungene Linien, schwarze Farbe und silberne Oberflächen kombiniert, um maximalen Komfort zu bieten. Der Stuhl verfügt über eine Hydraulikpumpe, mit der Sie den Sitz heben und senken können, so dass Sie den Kunden auf die Höhe bringen können, die für die jeweilige Arbeit am besten geeignet ist. Es kann mit 3 Füßen und mit der Option einer Fußstütze kombiniert werden.

*La poltrona da parrucchiere ART ha un design moderno che combina linee curve in nero e finiture argento pensato per offrire il massimo comfort. Altezza regolabil. Abbinabile a 3 piedistalli e con possibilità di poggiapiedi.*



REF.06094/50/2 REF.06094/50/5\*



REF.06094/50/3 REF.06094/50/6\*

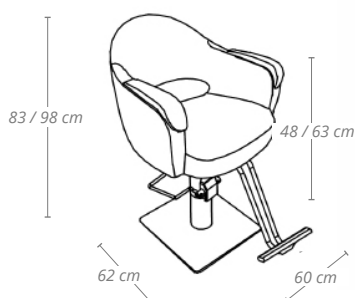

REF.06094/50/1 REF.06094/50/4\*

\* Mit Fußstütze  
\*Con poggiapiedi



### Tragbare aufblasbare Kopfwaschanlage Lavatesta portatile gonfiabile



1 u.m.vta  
20 box

REF.03923

### Tragbare Kopfwaschanlage Lavatesta portatile

1 u.m.vta  
12 box



REF. 04838/50

REF. 04838/70

REF. 04838/54

### Tragbare Kopfwaschanlage mit Fuß und Ablauf Lavatesta portatile con piedistallo e scarico



1 u.m.vta  
15 box

REF. 03736



\* Detail unterstützt Shampoos  
\* Il dettaglio supporta gli shampoo

### Tragbare Kopfwaschanlage Poltrona lavatesta portatile

1 u.m.vta  
1 box

REF.01970



» Höhenverstellbarer Fuß  
» Ablauf: 50 cm  
» Nicht kippsbar

» Piedistallo regolabile in altezza  
» Scarico: 50 cm  
» Non basculante



REF. 03736/68



REF. 03736/54

» Mit Fuß und Ablauf.  
» Mit Platz für Shampoos.  
» Kippbar.

» Con piedistallo e scarico.  
» Con foro per shampoo.  
» Basculante.

### Spülbehälter Ø 45- 21 cm Deposito lavatesta Ø 45-21 cm

1 u.m.vta  
5 box

250 ml

REF.03737



Geeignet für diese Modelle  
Adatto a questi modelli



REF. 03736



REF. 01970

### Tragbares Kopfwaschbrett mit Rückenstütze für Stühle Lavatesta portatile con sostegno per poltrone

2  
u.m.vta

2  
box



Kopfwaschanlage, bestehend aus einer Brett aus sehr leichtem Material, leicht zu montieren, in der Höhe verstellbar und sehr praktisch, um die Haarhygiene für Personen mit geringer Mobilität oder für Hausdienste durchzuführen.

Lavatesta composto da un tavolo in materiale molto leggero, facile da montare, regolabile in altezza e molto pratico per eseguire l'igiene dei capelli a persone con poca mobilità o per servizi a domicilio.

REF.06952

REF.06952/00

1  
u.m.vta

1  
box

Tragbares Eurostil-Kopfwaschbrett mit Befestigung an Rückenlehnen  
Lavatesta Eurostil con gancio per schienale

Tragbares Kopfwaschbrett mit Rückenlehnenbefestigung. No Name  
Lavatesta portatile con gancio per schienale. Anonimo



REF.RE06952/04



REF.RE06952/04/00

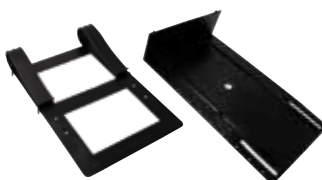

REF.RE06952/05

Schachtel mit 2  
Waschbretter Eurostil  
Confezione da 2  
Eurostil

Schachtel mit 2  
Waschbretter No Name  
Confezione 2  
Senza nome

Schachtel mit 2  
Befestigungen für  
Rückenlehnen  
Confezione 2 ganci per  
schienale



### Mobiler Rolltisch Carrello ausiliario

1  
u.m.vta

1  
box

**Gio**

REF.02366/50

**Jolly**

REF.00874

**Black**

REF.03215



**Verstellbarer Beistelltisch**  
**Carrello ausiliario regolabile**

REF.03843

» Mit Edelstahlfuß

» Con pianale in acciaio  
inossidabile**Beistelltisch mit 2 Färbfächern**  
**Carrello 2 vassoio per colore**

REF.03181

- » Spezialwagen für alle Arten von Färbe- und Bleicharbeiten
- » Mit Fassungsvermögen für mehrere Farbrührer, Schalen und einem speziellen Halter für die benötigte Aluminiumfolie für Strähnen.
- » Leicht und sehr handlich
- » Mit leicht lenkbaren Schwenkrollen

- » Carrello speciale per tutti i tipi di lavori di colore e decolorazione
- » Con capacità per diversi shaker, ciotole e una speciale sistemazione per i fogli di alluminio necessari per le meches
- » Leggero e molto maneggevole
- » Con ruote girevoli per un miglior movimento



### SWING Holzarbeitswagen Carrello SWING



Wagen mit zwei schwarzen Körpern bzw. 3 Schubladen (insgesamt 6) Er verfügt über 4 Räder, um beim Transport komfortabler zu sein. Die obere Ablage hat viel Platz und enthält mehrere Löcher, in denen verschiedene Objekte abgelegt werden können. Er beinhaltet auch einen Metallhalter zur Ablage eines Haartrockners.

*Carrello con due blocchi neri e 3 scomparti rispettivamente (6 in totale). Con 4 ruote per essere più comodo durante lo spostamento. Il vassoio superiore ha molto spazio e presenta vari fori pensati per sistemare oggetti diversi. Include anche un gancio in metallo per sostenere l'asciugapelli.*



REF.06279

### Arbeitswagen zum Färben Carrello per colore



- » Spezieller Arbeitswagen für alle Arten von Färbe- und Bleicharbeiten
- » Mit Kapazität für mehrere Farbpinsel, Rührbehälter, Schalen und zwei spezielle Unterbringungsmöglichkeiten für die Aluminiumfolie
- » Leicht und sehr handlich
- » Mit leicht lenkbaren Schwenkrollen

- » Carrello speciale per tutti i tipi di lavori di colore e decolorazione
- » Con capacità per varie palette, shaker, ciotole e due alloggi speciali per la sistemazione dei fogli di alluminio necessari per le meches
- » Leggero e molto maneggevole
- » Con ruote girevoli per un miglior movimento



REF.03180

### MASTER UP Friseur-Arbeitswagen Carrello per parrucchiere MASTER UP



REF.01963/50

### ZEPHIR Holzarbeitswagen Carrello in legno ZEPHIR



REF.01331

## Friseur-Arbeitswagen Carrello per parrucchiere



### Mod. Boy

REF.00877

### Mod. Smile

REF.04380

### Mod.Funny

REF.04381



## Friseur-Arbeitswagen Carrello per parrucchiere

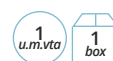

- » Arbeitswagen mit 6 herausnehmbaren und austauschbaren Schubladen
- » Mit Platz für Tuben, Schalen und Haartrockner
- » Werkstoff Polypropylen

- » Carrello ausiliario con 6 scomparti estraibili e intercambiabili
- » Con spazio indicato per mettere oggetti, ciotole e asciugacapelli
- » Materiale in polipropilene



REF.04276/50

**Handbrause mit Anschluss**  
**Doccia con supporto**

1  
u.m.vta

20  
box

REF.03004



**Aufsatz Dusch-Set**  
**Set doccia adattabile**

1  
u.m.vta

10  
box

REF.01960



**Einhandmischer für Waschbecken**  
**Miscelatore per lavatesta**

1  
u.m.vta

50  
box

REF.02837



**Ionischer Duschkopf**  
**Soffione doccia ionico**

1  
u.m.vta

36  
box

REF.03750



Spart Wasser Bessere  
 Wasserqualität

Risparmio idrico Migliore  
 qualità dell'acqua

**Handtuchhalter**  
**Organizer per appendere asciugamani**

1  
u.m.vta

6  
box

REF.04378



**Handtuch-Container**  
**Porta asciugamani**

1  
u.m.vta

4  
box

REF.03159



» Mit Rädern  
 » Waschbarer  
 Container-Beutel  
 » Struktur aus  
 rostfreiem Stahl

» Con ruote  
 » Borsa contenitore  
 lavabile  
 » Struttura in acciaio  
 inox

08

# Kämme und bürsten

PETTINI  
E SPAZZOLE

*Bürsten, Thermobürsten,  
Kämme, Friseurkoffer, Austeller...*

*Spazzole, spazzole termiche, pettini,  
astucci per parrucchieri, espositori...*



## Toupierbürsten

### Spazzole per cotonare

- » Naturborsten
- » Setole in nylon



REF.00105/50

- » Naturborsten
- » Setole di cinghiale



REF.02452

- » Naturborsten
- » Setole di cinghiale



REF.04528

3 Bürstenreihen, die höchste Reihe in der Mitte  
3 file di setole, la fila centrale più alta

- » Naturborsten
- » Setole in nylon



REF.00106



REF.00106/58

- » Naturborsten
- » Setole di cinghiale



REF.03171



REF.03171/58

- » Kunststoffbündel
- » Punte in plastica



REF.03880



REF.03880/58

- » Naturborsten
- » Setole di cinghiale



REF.03227

Hölzerne Bürste. Gebogener Form für bessere Handhabung  
Spazzole in legno. Corpo ricurvo per un migliore adattamento

- » Gummibürsten mit Stahlstiften + Kugeln
- » Punte in metallo con sfera



REF.00161



### Spiralbürsten mit Kunststoffgriff

Spazzole a spirale con manico in plastica



1  
u.m.vta

50  
box

REF. 01851



NYLON

Ø 20



1  
u.m.vta

40  
box

REF. 01598



NYLON

Ø 25



» Naturborsten  
» Setole di cinghiale

1  
u.m.vta

12  
box

REF. 02995



Ø 10



### Spiralbürsten mit Holzgriff

Spazzole a spirale con manico in legno

1  
u.m.vta

72  
box

REF. 00351



NYLON

Ø 25



1  
u.m.vta

30  
box

REF. 00502



NYLON

Ø 25



1  
u.m.vta

30  
box

REF. 01597



NYLON

Ø 32



## Rundholzbürste Spazzole in legno



NYLON

» Nylonbündel  
» Setole in nylon

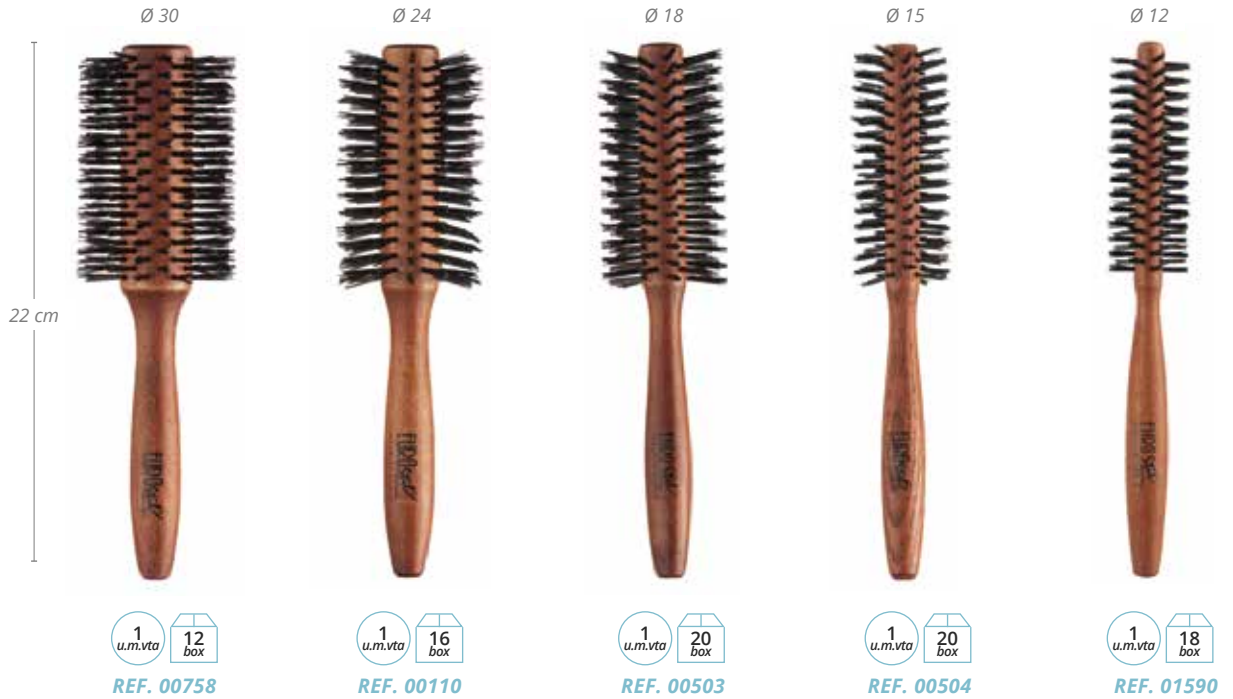

## JUMBO Kunststoff-Rundbürste Spazzole in plastica JUMBO



NYLON



» Nylonbündel  
» Setole in nylon

REF. 02178



## Rundholzbürste Spazzole in legno



» Nylonbündel und Naturborsten  
» Setole in nylon + cinghiale



» Lange Borsten  
» Setole lunghe

» Kurze Borsten  
» Short bristles

## Rundholzbürste Spazzole in legno



- » Nylonbündel+Kugeln
- » Setole in nylon + punta arrotondata



## Rundholzbürste Spazzole in legno



- » Naturborsten
- » Setole di cinghiale

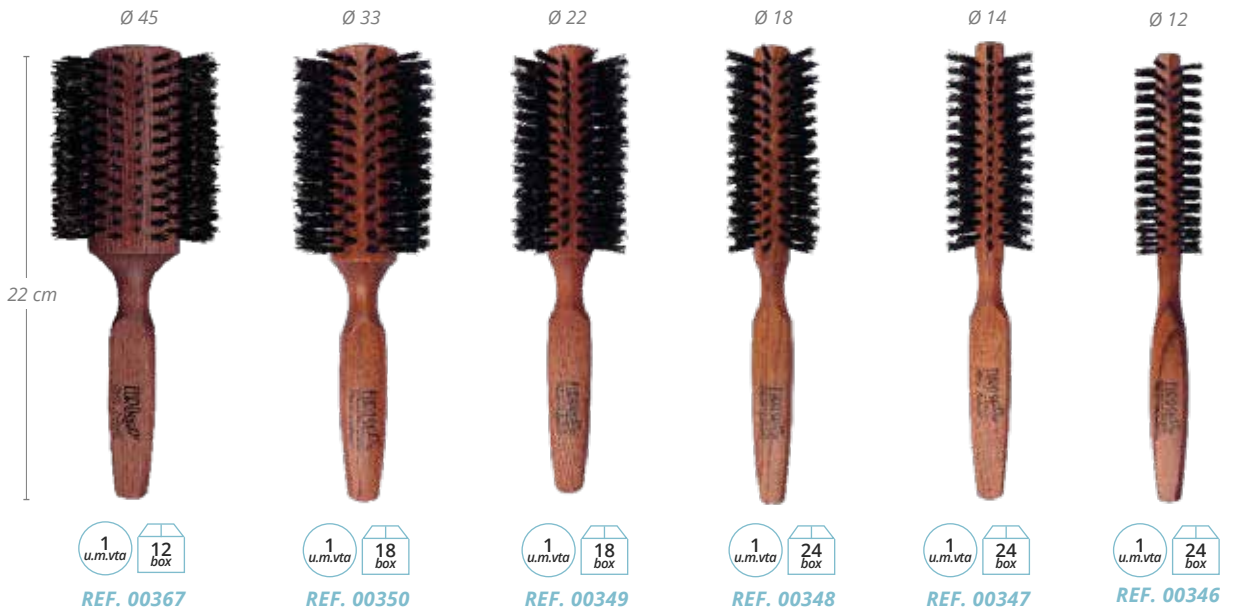

## Rundholzbürste mit Gummigriff

### Spazzole in legno con manico in gomma



» Nylonbündel und Naturborsten  
» Setole di nylon + cinghiale

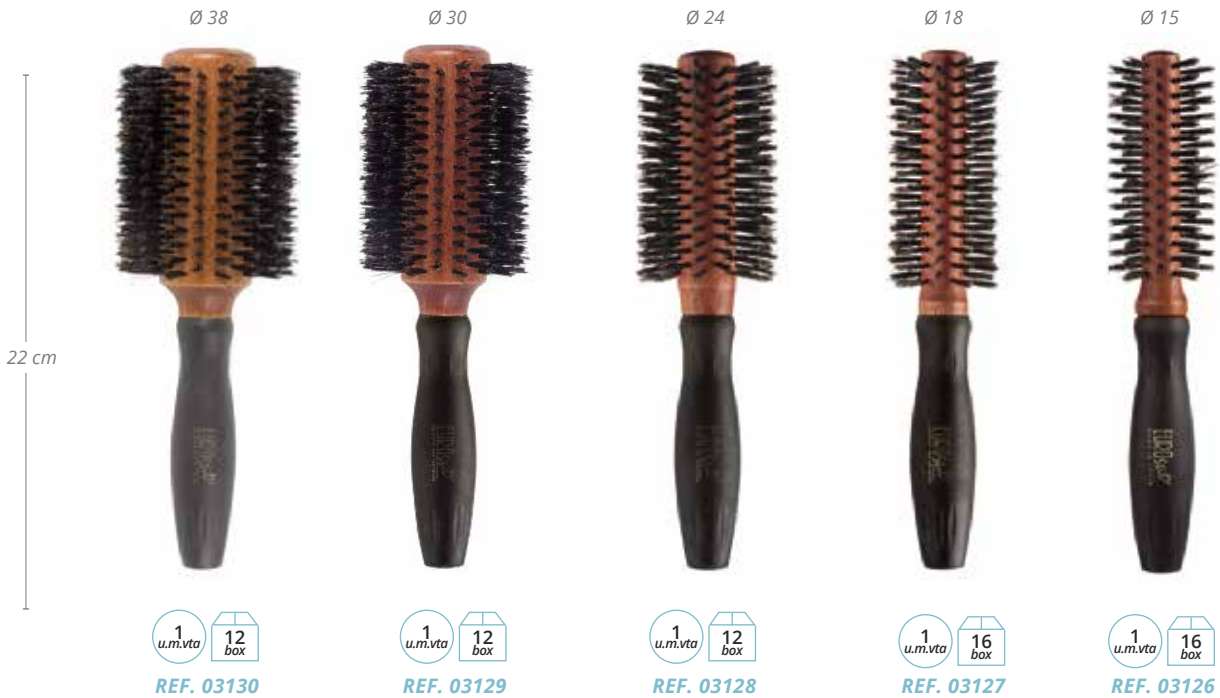

### Gummibürsten mit Holzgriff

#### Spazzole pneumatiche con manico in legno



» Naturborsten  
» Setole di cinghiale



REF. 00328



REF. 00327



REF. 00352



REF. 00326



REF. 00325

### Gummibürsten mit Holzgriff

#### Spazzole pneumatiche con manico in legno



» Nylonbündel und Naturborsten  
» Setole di nylon + cinghiale



REF. 00528



REF. 00529

## Gummibürsten mit Holzgriff

### Spazzole pneumatiche con manico in legno

- PLASTIC  
 » Kunststoffbündel  
 » Punte in plastica



REF. 00590



REF.00597



REF. 01994



REF.03298



REF.03299

- » Komfortable Bürste
- » Leicht zu entwirren
- » Ergonomisch und leicht
- » Klassisch und elegant

- » Spazzole comoda
- » Districa facilmente
- » Ergonomica e leggera
- » Classica ed elegante

## Holzaussteller 20 Bürsten

### Espositore in legno 20 spazzole



REF.03387



## Gummibürsten mit Holzgriff

### Spazzole pneumatiche con manico in legno



METAL

- » Stahlstiften mit Kugeln
- » Setole in metallo, con punte arrotondate



REF. 00146



REF. 00148



REF. 00147

## Bambusbürsten

### Spazzole di bambù



WOOD



- » Bürstenkörper und Borsten aus natürlichem Bambusholz
- » Kontrollierte Holzproduktion
- » Antistatische Bürste
- » Verleiht dem Haar Glanz und Geschmeidigkeit
- » Sehr widerstandsfähiges und flexibles Holz

- » Corpo della Spazzole e punte in legno di bambù naturale
- » Produzione controllata del legno
- » Spazzole antistatica
- » Dona lucentezza e morbidezza ai capelli
- » Legno molto resistente e flessibile



REF. 03223



REF. 03224



REF. 03225



REF. 03226



### Gummibürsten mit Holzgriff

#### Spazzole pneumatiche con manico in legno



- WOOD  
 » Holzstiften  
 » Setole in legno



REF. 01922



REF. 01921



REF. 01920



REF. 01919

### Gummibürsten mit Holzgriff

#### Spazzole pneumatiche con manico in legno

- NYLON  
 » Nylonbündel  
 » Setole in nylon



1 u.m.vta  
 70 box

REF. 01924

Groß  
 Big



1 u.m.vta  
 50 box

REF. 01923

Wenig  
 Small



### Rechteckige Gummibürsten

#### Spazzole pneumatica a paletta rettangolare

- PLASTIC  
 » Kunststoffbündel  
 » Holz



- » Setole in plastica  
 » Legno

REF. 02463/99



## Gummibürsten mit Holzgriff

### Spazzole pneumatiche, districanti



PLASTIC

- » Kunststoffbündel mit kugeln
- » Setole in plastica, con punte arrotondate



REF. 04282



REF. 04281



REF. 04280



REF. 04279



**Gummibürsten mit Holzgriff**  
**Spazzole pneumatiche con manico in plastica**



» Naturborsten oder Nylon  
 » Setole di cinghiale e nylon



REF. 03691



REF. 03690



REF. 03693



REF. 03689

**Bürste mit kunststoffgriff**  
**Spazzole pneumatiche con manico in plastica**



» Naturborsten oder Nylon  
 » Setole di cinghiale e nylon



REF. 01472



REF. 01471

## Gummibürsten und Kunststoffgriff

### Spazzole pneumatiche con manico in plastica



- » Naturborsten
- » Setole di cinghiale

PLASTIC

- » Kunststoffbündel
- » Setole in plastica

PLASTIC

- » Kunststoffbündel mit Kugeln
- » Setole in plastica, con punte arrotondate



1 u.m.vta  
12 box

REF. 00767



1 u.m.vta  
12 box

REF. 00793



1 u.m.vta  
24 box

REF. 00755

## Ovale Profi-Bürste

### Spazzola pneumatica ovale professionale



1 u.m.vta

18 box

REF. 00337

PLASTIC

- » Kunststoffbündel mit Kugeln
- » Setole in plastica, con punte arrotondate

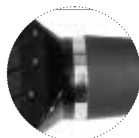

## Gummibürsten mit Holzgriff

### Spazzole pneumatiche con manico in legno



METAL

- » Stahlstiften mit Kugeln
- » Setole di metallo, con punte arrotondate

1 u.m.vta  
36 box

S

REF. 00158/50

REF. 00158

1 u.m.vta  
24 box

M

REF. 00159/50

REF. 00159

1 u.m.vta  
24 box

L

REF. 00160/50

REF. 00160



## Gummibürsten mit Holzgriff

### Spazzole pneumatiche con manico in plastica



METAL

- » Stahlstiften mit Kugeln
- » Antistatische Bürste

- » Setole in plastica con punte arrotondate
- » Spazzole antistatica

1 u.m.vta  
12 box

REF. 00587

1 u.m.vta  
12 box

REF. 00586



### Gummibürsten mit Holzgriff

#### Spazzole pneumatiche con manico in plastica



NYLON

» Nylonbündel  
» Setole in nylon



### Gummibürsten mit Holzgriff

#### Spazzole pneumatiche con manico in plastica



NYLON

» Nylonbündel mit Kugeln  
» Setole in nylon con punte arrotondate



## Gummibürsten mit Holzgriff

### Spazzole pneumatiche con manico in plastica



- » Naturborsten
- » Setole di cinghiale



1 u.m.vta  
12 box  
S

REF. 00303



1 u.m.vta  
12 box  
M

REF. 00304



1 u.m.vta  
12 box  
L

REF. 00305

## Gummibürsten mit Holzgriff

### Spazzole pneumatiche con manico in plastica



- » Kunststoffbündel
- » Punte in plastica

- » Kunststoffbündel mit Kugeln
- » Setole in plastica con punte arrotondate

- » Kunststoffbündel mit Kugeln
- » Setole in plastica con punte arrotondate

- » Kunststoffbündel mit Kugeln
- » Setole in plastica con punte arrotondate



1 u.m.vta  
18 box

REF.00309



1 u.m.vta  
24 box

REF. 00155/50



1 u.m.vta  
24 box

REF. 00156/50



1 u.m.vta  
36 box

REF. 00157/50

**Gummibürsten mit kunststoffgriff**  
**Spazzole pneumatiche con manico in plastica**



» Nylonbündel  
 » Setole in nylon



» Naturborsten  
 » Setole di cinghiale



REF. 03091



REF. 03088



REF. 03092



REF. 03089

**Gummibürsten mit Kunststoffgriff**  
**Spazzole pneumatiche con manico in plastica**



» Kunststoffbündel mit Kugeln  
 » Setole in plastica con punte arrotondate



REF. 03093



REF. 03090



### Gummibürsten mit Gummigriff

Spazzole pneumatiche con manico in gomma



» Kunststoffbündel mit Kugeln

» Setole in plastica con punte arrotondate



1 u.m.vta 12 box

S

REF. 03101



1 u.m.vta 12 box

M

REF. 03098



1 u.m.vta 6 box

L

REF. 03103

### Gummibürsten mit Gummigriff

Spazzole pneumatiche con manico in gomma



» Naturborsten

» Setole di cinghiale



1 u.m.vta 12 box

S

REF. 03100



1 u.m.vta 12 box

M

REF. 03308



1 u.m.vta 6 box

L

REF. 03102

### Skelettbürste mit Gummigriff

Spazzole pneumatiche con manico in gomma



NYLON

- » Nylonbündel
- » Setole in nylon



1  
u.m.vta

12  
box

REF. 03309



1  
u.m.vta

12  
box

REF. 03099

### Skelettbürste mit Gummigriff

Spazzole scheletro con manico in gomma

PLASTIC

- » Kunststoffbündel mit Kugeln
- » Setole in plastica con punte arrotondate

1  
u.m.vta

12  
box



S

REF. 03095



L

REF. 03094

### Thermische Bürsten

Spazzole termiche

- » Auch erhältlich: Thermobürsten aus zwei Materialien

» Sono disponibili anche spazzole termiche bimatereiale

PÁG.236



REF. 03349



REF. 03348



REF. 03347



REF. 03346

## Gummibürsten Spazzole pneumatiche



PLASTIC

- » Kunststoffbündel mit Kugeln
- » Setole in plastica con punte arrotondate



REF.03202

Bürsten mit einer Gummiplatte, die sich perfekt an die Form des Kopfes anpassen und einen breiten und weichen Bürsteeffekt erzielen. Kunststoffborsten mit kugelförmiger Oberfläche in der Farbe der Bürste. Komfortabler und benutzerfreundlicher Griff.

*Spazzole pneumatiche che si adattano perfettamente alla forma della testa fornendo un effetto Spazzoletura ampio e morbido. Punte in plastica con finitura a sfera dello stesso colore della Spazzole. Manico comodo e piacevole da usare.*



## Entwirrende Bürste

### Spazzole districanti



REF. 03881

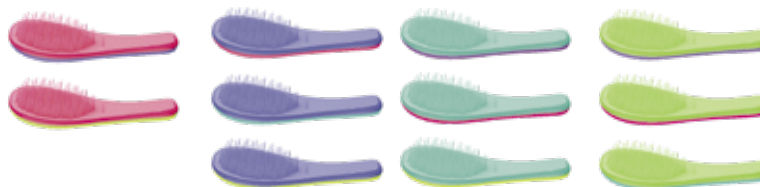

- » 3 Borstenhöhen: 120 kleine Borsten, 123 mittlere Borsten, 119 lange Borsten
- » Ergonomischer Griff
- » Flexibel und glatt, aber effizient
- » Hochwertiges Thermoplast
- » Für nasses oder trockenes Haar
- » Es bricht das Haar NICHT
- » Leicht und komfortabel in der Anwendung
- » Mit geringer statischer Aufladung
- » Chemische Beständigkeit
- » Gebogen zur besseren Anpassung an den Kopf
- » Zweifarbiges Bürste (verschiedene Farben)

- » 3 altezze delle setole: 120 setole piccole, 123 medie, 119 grandi
- » Impugnatura ergonomica
- » Flessibile e delicata ma efficiente
- » Termoplastica di prima qualità
- » Per capelli bagnati o asciutti
- » NON rompe i capelli
- » Leggera e comoda da usare
- » Bassa carica statica
- » Resistente ai prodotti chimici
- » Con curvatura per adattarsi meglio alla testa
- » Spazzole bicolore (colori assortiti)



REF. 03881/97



## Aussteller mit 120 entwirrenden Bürsten

### Espositore 120 spazzole districanti

1  
u.m.vta

1  
box

» Verschiedene Farben  
» Assortimento di colori

REF.04875

» Metallic-Farben  
» Colori metallizzati

REF.04875/97

REF.04875/01



## 3d-Kugelbürste

### Spazzole sferica 3D

1  
u.m.vta

12  
box

PLASTIC

3D-Kugelbürste. Verhindert, dass sich die Haare verheddern. Kann um 360° gedreht werden, um Locken und Wellen zu erzeugen. Seine abstehenden Borsten ermöglichen eine bessere Luftzirkulation und verkürzen die Trocknungszeit um die Hälfte.

*Spazzole sferica 3D Evita che i capelli si aggroviglino Può essere ruotata di 360° per creare riccioli e onde. Le sue punte distanziate consentono una migliore circolazione dell'aria riducendo della metà i tempi di asciugatura.*



REF. 04968

**Farbige entwirrende Bürste**  
Spazzole districanti colori assortiti

» Kunststoffbündel  
» Punte in plastica

S

REF. 04600

**Aussteller für entwirrende Bürsten**  
Espositore per spazzole districanti

**STOP ruckt, STOP verwickelt  
sich, Hör auf zu krausen**

**STOP cretini, STOP grovigli,  
STOP all'effetto crespo**

L

REF. 04562



S

REF. 04886



L

REF. 04885



Aussteller mit 12 Spezialbürsten zum Entwirren. Mit sehr flexiblen Borsten in verschiedenen Höhen, die auch ohne Conditioner helfen, Knoten zu entwirren. STOPPT verheddern, STOPPT Ziehen, STOPPT Frizz. Jeder Aussteller hat 4 exklusive Drucke oder Designs.

Espositore con 12 spazzole speciali per districare. Con punte molto flessibili a diversi livelli che aiutano a sciogliere i nodi anche senza lavare con balsamo. STOP ai grovigli, STOP alle tirate, STOP all'effetto crespo. Ogni espositore dispone di 4 stampe o disegni esclusivi.

### Aussteller 20 Holzbürsten Espositore per 20 spazzole in legno

1  
u.m.vta

4  
box

REF.03387

PLASTIC » Gerade Kunststoffborsten  
» Punte dritte in plastica

WOOD



Enthält 4 Stück pro  
Referenz  
Include 4 spazzole  
per referenza

REF. 03299  
REF. 03298  
REF. 00590  
REF. 01994  
REF. 00597

### Aussteller mit 12 rechteckigen Holzbürsten Espositore per 12 spazzole rettangolari in legno

1  
u.m.vta

1  
box

REF.01166

PLASTIC » Gerade Kunststoffbündel  
» Punte dritte in plastica

WOOD



Enthält 12 Stück  
Include 12 unità

REF. 00590

### Aussteller 12 große Gummibürsten Espositore per 12 spazzole pneumatiche grandi

1  
u.m.vta

1  
box

REF.01165

NYLON » Nylonbündel  
» Setole in nylon



Incluye 12 unidades  
Include 12 unità

REF. 00133



**Aussteller mit 20 Thermobürsten**  
**Espositore per 20 spazzole termiche**



REF.01176

NYLON



Enthält 4 Stück pro  
Referenz  
 Include 4 spazzole  
per referenza

REF. 00579  
 REF. 00580  
 REF. 00581  
 REF. 00582  
 REF. 00780

**Aussteller 12 TUNEL-Skelettbürsten**  
**Espositore per 12 spazzole scheletro TUNEL**



REF.01167

PLASTIC

» Kunststoffbündel mit Kugeln  
 » Setole in plastica con punte  
 arrotondate



Enthält 12 Stück  
 Include 12 unità

REF. 01165



**Aussteller mit 24 beheizte bürsten**  
**Espositore per 24 spazzole termico**



REF.07431

NYLON

» Nylonbündel  
 » Setole in nylon



NEW

Enthält 4 Einheiten  
 durch Referenzen

Include 4 unità  
 per riferimenti

REF. 03355  
 REF. 03356  
 REF. 03357  
 REF. 03358  
 REF. 03359  
 REF. 03360



## Farbige Skelettbürsten

### Spazzole scheletro colorata

PLASTIC

- » Kunststoffbündel mit kugeln
- » Setole in plastica con punte arrotondate

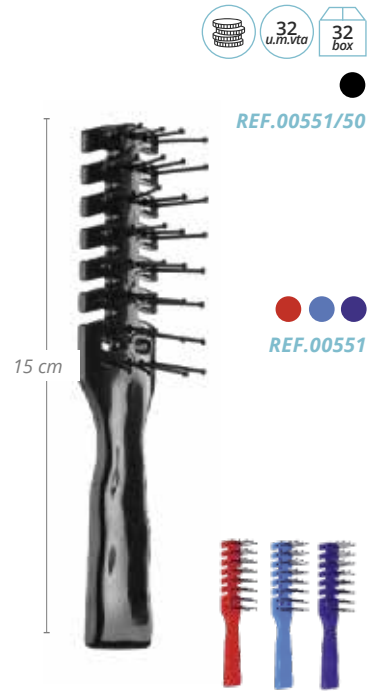
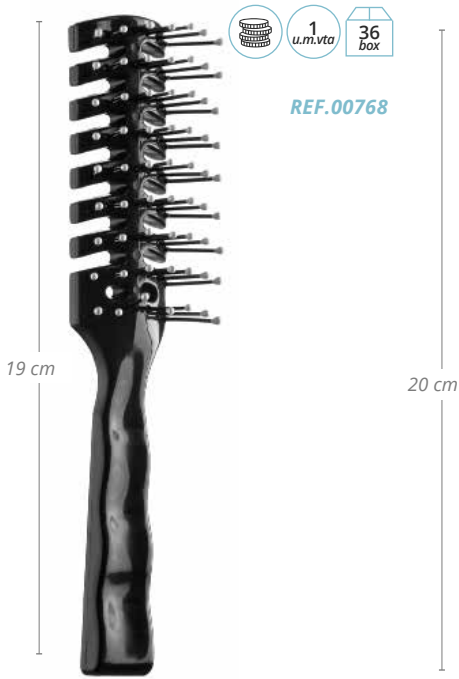

## Skelettbürste metallic mit großer borstenkugel

### Spazzola scheletro con due punte arrotondate in metallo, grande

PLASTIC

- » Kunststoffbündel mit Kugeln. Verschiedene Farben
- » Punte in plastica con sfere Colori assortiti

20 u.m.vta  
20 box

REF.00550/97



**Farbige Skelettbürsten aus Gummi**  
**Spazzole scheletro con gomma colorata**



- » Kunststoffbündel mit Kugeln
- » Setole in plastica con punte arrotondate

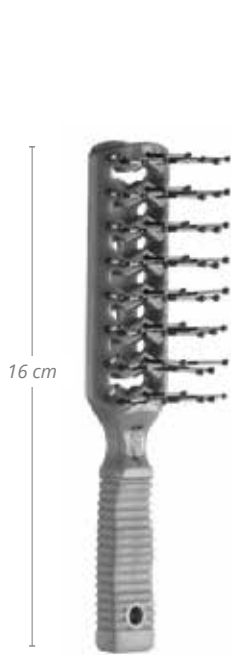

REF.00575

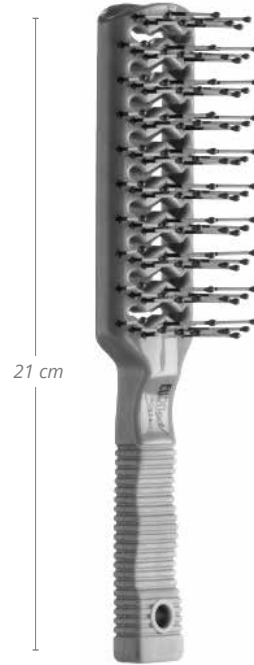

REF.00574



REF.00576



REF.00754



**Skelettbürsten****Spazzole scheletro**

PLASTIC

» Kunststoffbündel mit kugeln  
 » Setole in plastica con punte arrotondate

12  
u.m.vta 12  
box

S

REF.03087

12  
u.m.vta 12  
box

L

REF.03086

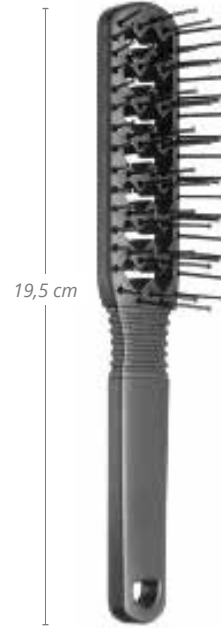
1  
u.m.vta 16  
box

REF. 02203/50

REF. 02203

**Anti-statische Skelettbürsten****Spazzole scheletro ANTISTATICHE**

PLASTIC

» Kunststoffbündel mit kugeln  
 » Setole in plastica con punte arrotondate

S

REF.00585



17,50 cm

L

REF.00584



21 cm

1  
u.m.vta 12  
box

## Farbige Skelettbürsten

### Spazzole scheletro colorate

PLASTIC

» Kunststoffbündel  
» Punte in plastica



## Farbige Skelettbürsten

### Spazzole scheletro flessibili

PLASTIC

» Stahlstiften  
» Punte metalliche

1 u.m.vta 12 box

S  
REF. 04405

L  
REF. 04406



## Farbige Skelett-Kurvenbürsten

### Spazzole scheletro ricurve e colorate

PLASTIC

- » Kunststoffborsten mit kugel
- » Setole in plastica con punte arrotondate



REF. 02195

REF. 02195/50



REF.03201

22 cm

Gebogene Bürsten zur besseren Anpassung an die Kopfform, leicht und bequem in der Anwendung durch ergonomisches Design. Elf Reihen anatomisch geformter Kunststoffbündel mit kugelförmiger Oberfläche in der gleichen Farbe wie die Bürste.

Spazzole ricurve per un migliore adattamento alla forma della testa, leggere e comode da usare grazie al loro design ergonomico. Undici file di punte dalla forma anatomica in plastica con finitura a sfera dello stesso colore della Spazzole.

## Doppel-Skelettbürsten

### Spazzole scheletro doppie



PLASTIC

- » Kunststoffbündel mit kugeln verschiedene farben
- » Setole in plastica con punte arrotondate, colori assortiti

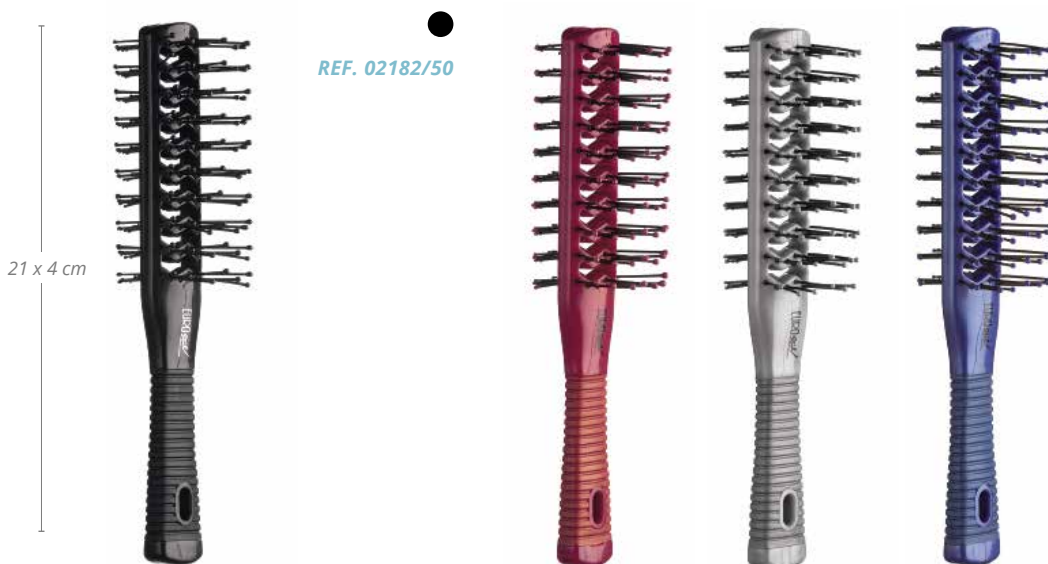

REF. 02182/50

REF. 02182

### Kunststoffgriff Entwirrungsbürste

#### Spazzole districanti con manico in plastica



- » Zwei Höhen Bündel mit Kugeln
- » Punta a doppia altezza con doppia punta arrotondata



REF.06609

- » Bürstensortiment, die speziell für gebrochenes Haar entwickelt wurde



- » Linea di spazzole pensata appositamente per capelli che si spezzano

REF.06610



16,5 cm



21 cm

### Flachbürste aus Plastik

#### Spazzole piatta in plastica



- » Kunststoffbündel mit Kugeln
- » Setole in plastica con punte arrotondate



REF.00571



REF.00570

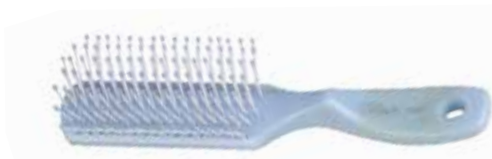

### Flachbürste aus Gummi

#### Spazzole piatta in gomma



- » Kunststoffbündel
- » Punta in plastica

REF. 04700

### Faltbare Bürste mit Spiegel

#### Spazzole pieghevole con specchio



- » Kunststoffbündel mit Kugeln
- » Setole in plastica con punte arrotondate

REF.00329

REF.00329/50



### Cepillo plástico

#### Spazzole in plastica



- » Kunststoffbündel
- » Punta in plastica

REF.01850/50

REF.01850

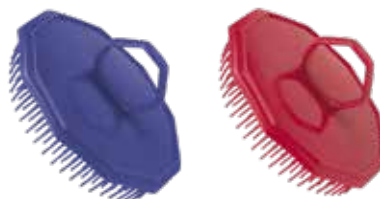

**Lockenbürste**  
*Spazzole arricciacapelli*

REF.00386

PLASTIC

**Professioneller Glättkamm**  
*Pettine professionale per piastra*

REF. 03262

**Doppelte Thermobürste zum Glätten. Verwendung mit Trockner**  
*Doppia Spazzole termica per lisciare. Utilizzare con asciugacapelli*

REF. 01957

- » Naturborsten
- » Setole di cinghiale

REF. 02365



**Lauskamm****Pettini per la pulizia dei pidocchi**

- » Polypropylen-Kamm
- » Kunststoffbündel

- » Pettine per la pulizia dei pidocchi in polipropilene
- » Punte in plastica

REF. 00443



REF. 00443/50

**Lauskamm****Pettini per la pulizia dei pidocchi**

- » Stahlstiften
- » Setole metalliche

REF.03305

**Babybürste und Kamm****Spazzole e pettine per neonati**

REF.00670

REF.00670/75



REF.00670/70



**Kamm mit Wasserwaage**  
**Pettine con livelle**

Dank seiner drei Wasserwaagen ermöglicht er das Schneiden oder Scheiteln in einer perfekten geraden Linie  
*Grazie alle sue tre livelle, consente di tagliare o scalare in perfetta linea retta*



REF. 04349

» Kamm-Reinigungsbürste  
 » Spazzole per la pulizia del  
 pettine



REF. 00600

» Bürsten-Set und silbriger Kamm  
 » Set spazzola/pettine, color argento



REF. 03488



## Keramik-ionische Thermobürste mit Gummigriff

### Spazzole termoceramiche ioniche con manico in gomma



NYLON

- » Mit Keramikbeschichtung, um dem Haar mehr Glanz und Schutz zu verleihen, und ionischer Beschichtung, die Kräuseln verhindert
- » Mit Gummigriff mit rutschfester Oberfläche
- » Nylonbündel
- » Abnehmbarer Borsten
- » Mit Aufhänger



- » Con rivestimento in ceramica per donare ai capelli più lucentezza e protezione e ioniche per prevenire l'effetto crespo
- » Con impugnatura in gomma con finitura antiscivolo
- » Setole in nylon
- » Punta rimovibile
- » Con gancio



**Thermobürste mit rundem Kunststoffgriff**  
**Spazzole termiche con manico rotondo in plastica**

NYLON

- » Nylonbündel
- » Mit Aufhänger

- » Setole in nylon
- » Con gancio

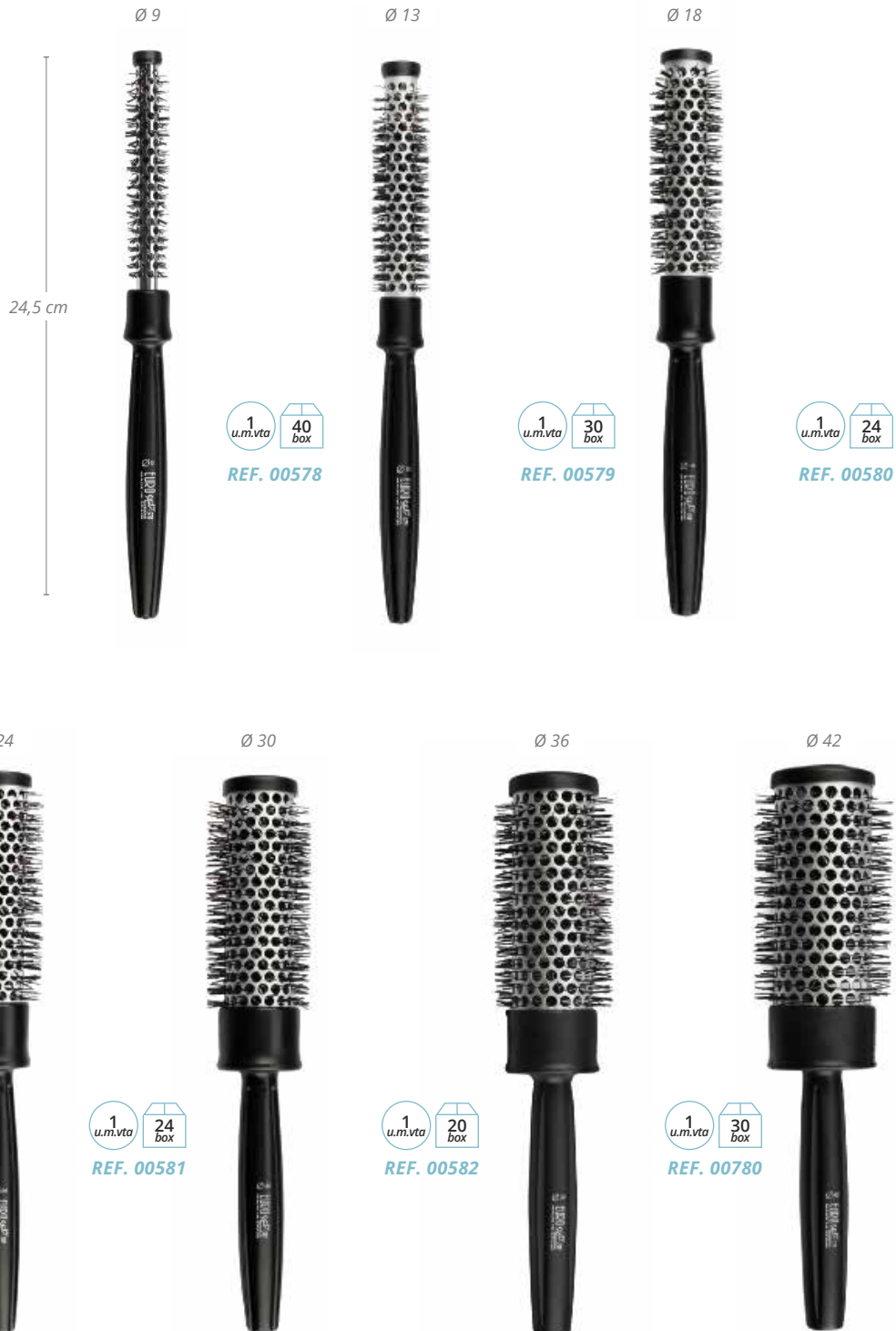
**GESCHLOSSENES ALUMINIUMROHR**  
**TUBO CHIUSO IN ALLUMINIO**

**Thermobürste mit Kunststoffgriff und offenem Aluminium-Flachrohr**  
**Spazzole termiche con manico in plastica e tubo piatto aperto in alluminio**



NYLON

- » Nylonbündel
- » Mit Aufhänger

- » Setole in nylon
- » Con gancio

Ø 13



24,5 cm

1 u.m.vta  
30 box

REF. 00355

Ø 18



1 u.m.vta  
24 box

REF. 00356

Ø 24



1 u.m.vta  
24 box

REF. 00357

Ø 30



1 u.m.vta  
20 box

REF. 00358

Ø 36



1 u.m.vta  
30 box

REF. 00359

Ø 42



1 u.m.vta  
20 box

REF. 00360

Ø 50



1 u.m.vta  
16 box

REF. 02661

Ø 61



1 u.m.vta  
12 box

REF. 02662

**Aluminium-Thermobürste mit Gummigriff**  
Spazzole termiche in alluminio con manico in gomma

- NYLON
- » Nylonbündel
  - » Mit Aufhänger

- » Setole in nylon
- » Con gancio

**Keramik Thermobürste mit Holzgriff**  
Spazzole termoceramiche con manico in legno

NYLON

Die neueste Generation Keramik Thermobürsten hat einen zentralen Körper aus keramikbeschichtetem Aluminium, um eine hohe Festigkeit und eine gleichmäßige Wärmeverteilung entlang des Bürstenkörpers zu gewährleisten.

- » Nylonbündel
- » Mit Aufhänger

Le spazzole termoceramiche di ultima generazione hanno un corpo centrale in alluminio rivestito in ceramica per garantire un'elevata resistenza e una distribuzione uniforme del calore in tutto il corpo della Spazzole.

- » Setole in nylon
- » Con gancio



**Thermobürste mit Holzgriff**  
Spazzole termiche con manico in legno

Der Bürstenkörper besteht aus Metall und Holz  
Il corpo della Spazzole è metallico e in legno

» Naturborsten und Nylonbündel mit 2 Ebenen zur Verbesserung des Halts des Haars. In Spanien entwickelte Bürstenlinie für dichtes Haar mit Volumen

» Setole di cinghiale e nylon a 2 livelli per migliorare la tenuta dei capelli. Linea di spazzole sviluppata in Spagna per capelli densi e voluminosi

**Thermische Rundbürste mit Gummigriff**  
Spazzole con manico termico in gomma

» Nylonbündel + Naturborsten. Der Bürstenkörper besteht aus Metall und Holz  
» Setole di nylon + cinghiale Il corpo della Spazzole è metallico e in legno



**Profi-Schneidekämme**  
Pettini da taglio professionali

20 cm

  
REF. 04616

  
REF. 04616/97

  
REF. 04616/98

  
REF. 04616/99
**Spezial-Schneidekamm**  
Pettine da taglio con denti speciali

17,5 cm

  
REF. 00441

  
REF. 00441/98

  
REF. 00441/99

### Spezial-Schneidekamm

Pettine da taglio con denti speciali



REF. 00442

» Verstärker  
» Rinforzato

REF. 00424

» Extralang  
» Super lungo

REF. 01470



### Großer Schneidekamm

Pettine da taglio grande



REF. 00115

REF. 00115/97

REF. 00115/98

REF. 00115/99



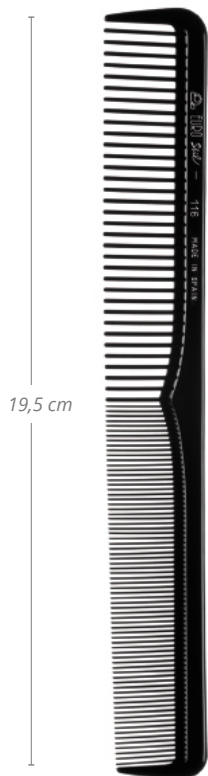

**Spezial-Schneidekamm***Pettine da taglio con denti speciali*

19,5 cm

  
REF. 00116

  
REF. 00116/97

  
REF. 00116/98

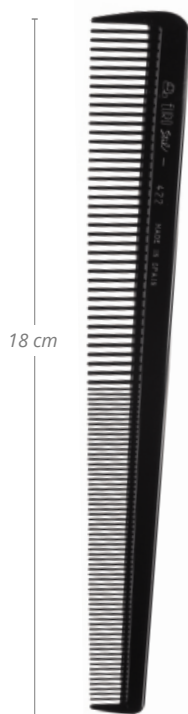
  
REF. 00116/99
**Spezieller Friseurkamm***Pettine speciale per parrucchiere*

18 cm

  
REF. 00422

  
REF. 00422/98

  
REF. 00422/99

  
REF. 00422/58

### Spezial-Nadelstielkamm

Pettine con denti speciali e punta



» Doppelte Zinkenhöhe  
» Doppia altezza dei denti

●  
REF. 00423

● ● ● ● ●  
REF. 00423/97

● ● ● ● ●  
REF. 00423/98

● ● ● ● ●  
REF. 00423/99

20,5 cm



### Nylon-Kamm

Pettine con denti in nylon



●  
REF. 00114

● ● ● ● ●  
REF. 00114/99

20,5 cm



**Nylonkamm Stahlnadel**  
Pettine con denti in nylon e punta in metallo

REF. 00118

REF. 00118/99

**Kamm Metallnadel**  
Pettine punta in metallo

REF. 01467



REF. 01468

 » Breit Metallnadel  
 » Punta larghe

**Schwarzer gebogener Fingerkamm**  
*Pettine districante curvo nero*



REF. 00127/50

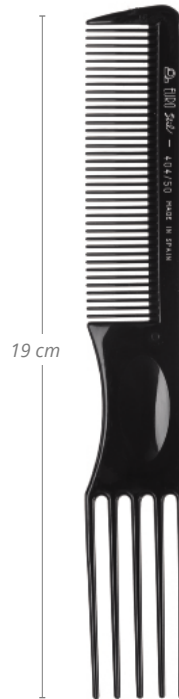

REF. 00404/50

**5-Zinken Fingerkamm, Spezialmetall**  
*Pettine speciale con 5 punte in metallo*



REF. 01469



REF. 01469/98



REF. 01469/99



**5-Zinken Fingkamm Stahl**  
*Pettine districante con 5 punte in metallo*

REF. 00128



REF. 00128/98



REF. 00128/99



» Spezial-Schneidekamm für  
» professioneller Maschinentrimmer



REF. 02472

» Professioneller Schneidekamm  
» Pettine da taglio professionale



REF. 02304

» Pettine da taglio speciale  
» per rifilatrice professionale

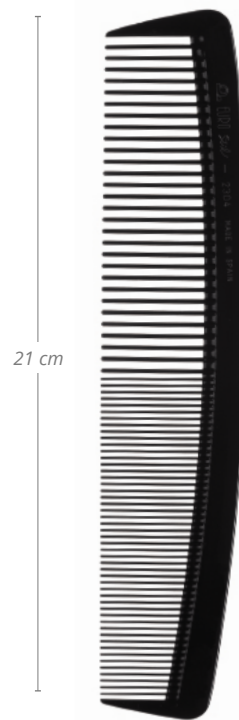

### Strähnen-Schneidkamm Pettine per meches

12  
u.m.Vta48  
box

REF. 00455

18  
u.m.Vta54  
box

REF. 00455/99



### Gerader Schneidekamm Pettine da taglio dritto

12  
u.m.Vta48  
box

REF. 00454



REF. 00454/99



### Professionelle Kämmе Eurostil Pettine professionali Eurostil

» Doppelzinken  
Kunststoffkamm  
» Pettine da taglio  
in plastica a  
doppio dente



REF. 00452



18 cm

### Spezial-Schneidekamm für Maschinenschnitt Eurostil Pettine taglio speciale macchina professionali Eurostil



MOD. 06802

REF. 07364

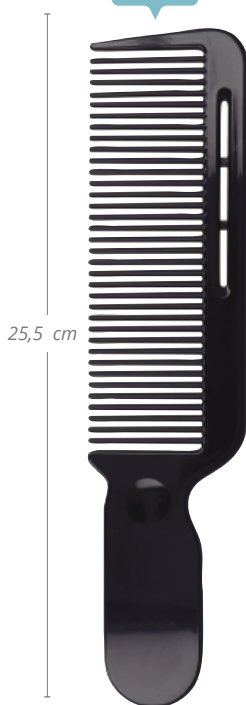

25,5 cm



MOD. 06802/82

REF. 07364/58



25,5 cm

### Großer Frisierkamm Pettine a denti grandi



REF. 02183



25,5 cm



20,5 cm



REF. 00453



REF. 00453/99



**Schwarzer Haarschneidekamm**  
**Pettine da taglio nero**



12

u.m.Vta

48

box

L

REF. 00136

P.V.P.R 0,60€

REF. 00136/50



22 cm



REF. 00136/97



REF. 00136/98





**Spender 100 Kämme Einweg versiegelt**  
**Dispenser 100 pettini monouso sigillati**1  
u.m.vta3  
boxVersiegelter Kamm zur Gewährleistung  
der Erstbenutzungsgarantie.

REF.03053

» Klassische Farben  
» Colori classici

REF.03053/98

*Pettine sigillato per offrire la garanzia di non  
essere stato utilizzato nei servizi precedenti.*

17,5 cm

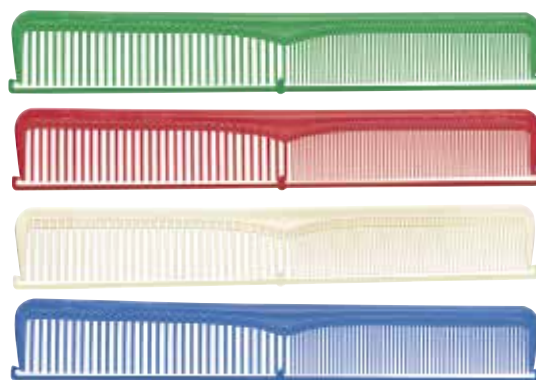
» Metallic Farben  
» Colori metallizzati

REF.03053/97

» Sommer-Farben  
» Colori estivi

REF.03053/99

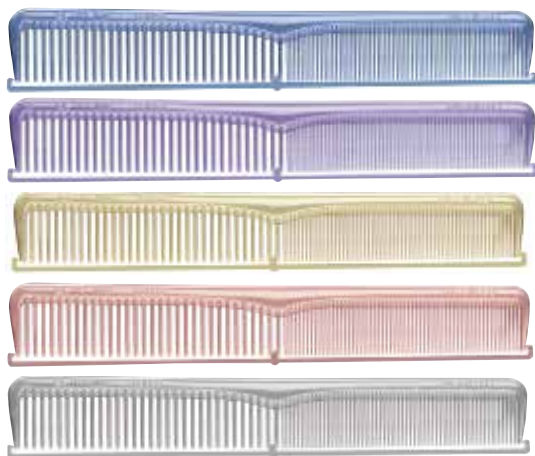

## Professionelle Kämmе farbige Pettini professionali colorati

Die Profi-Kämmе jetzt in lustigen Farben, um Ihren Salon attraktiver und fröhlicher zu gestalten. Die Referenzen, die mit /99 enden, sind die von farbigen Kämmеn: Grün, Blau, orange, Rosa, Pink und Lila. Auf dem Foto können Sie den Chromeffekt erkennen.

*Pettini professionali ora in divertenti colori per rendere il tuo salone più attraente e allegro. I codici che terminano con /99 sono quelli dei pettini colorati assortiti: verde, blu, arancio, rosa, fucsia e viola. Nella foto è possibile vedere la gamma cromatica.*

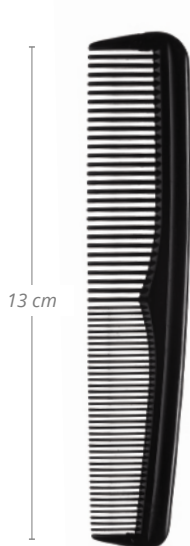

12  
u.m.vta 60  
box

REF. 00177/50

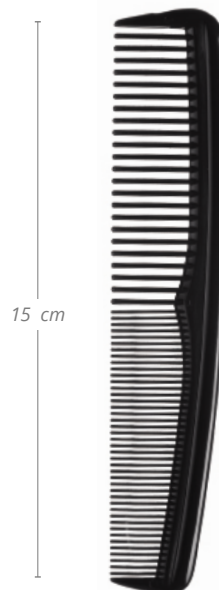

12  
u.m.vta 60  
box

REF. 00178/50

12  
u.m.vta 120  
box

REF. 00179/50



12  
u.m.vta 60  
box

REF. 00180/50



12  
u.m.vta 72  
box

REF. 00113



**Kämme aus CARBON**  
**Pettini in CARBONIO**» Schneidekamm  
» Pettine da taglio12  
u.m.vta 72  
box

REF. 02186



17,5 cm

» Schneidekamm  
» Pettine da taglio12  
u.m.vta 72  
box

REF. 02216

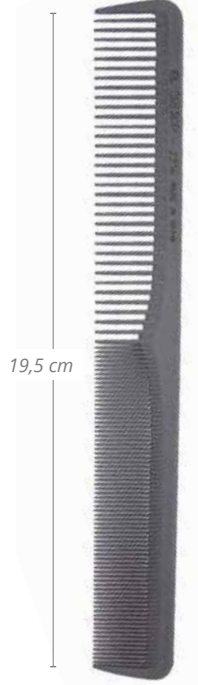

19,5 cm

» Spezial Zinkenkamm  
» Pettine speciale da parrucchiere12  
u.m.vta 96  
box

REF. 02214

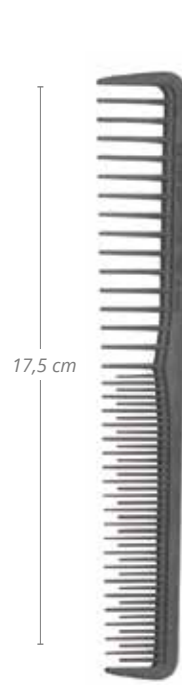

17,5 cm

» Frisierkamm  
» Pettine speciale da parrucchiere12  
u.m.vta 72  
box

REF. 02215



18 cm

» Spezial Zinkenkamm  
» Punta speciale12  
u.m.vta 72  
box

REF. 02187



20,5 cm

» Großer Schneidekamm  
» Pettine da taglio dritto12  
u.m.vta 48  
box

REF. 02188

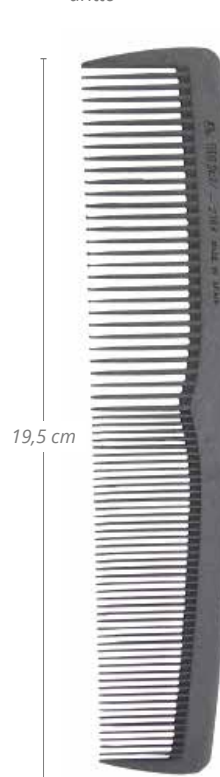

19,5 cm

**Kämme aus CARBON****Pettini in CARBONIO**

» Schneidekamm-Trennzinken  
 » Pettine da taglio con denti separatori

12  
u.m.vta

240  
box

REF. 03408



» Schneidekamm-Trennzinken  
 » Pettine da taglio con denti separatori

12  
u.m.vta

240  
box

REF. 03407



» Trennkamm  
 » Pettine con denti separatori

12  
u.m.vta

192  
box

REF. 03406

» Professioneller  
 Metallnadelstielkamm  
 » Pettine professionale con  
 punta in metallo

12  
u.m.vta

240  
box

REF. 03411

» Professioneller  
 Stielkamm  
 » Pettine  
 professionale

12  
u.m.vta

240  
box

REF. 03410



**Auswahl kämme massenkonsum**  
**Pettini senza logo, per grane distribuzione**

120  
u.m.vta

120  
box

» Schneidekamm  
 » Pettine da taglio

REF.00458



» Toupierkamm, Kunststoff  
 » Pettine con punta in plastica

REF.00459

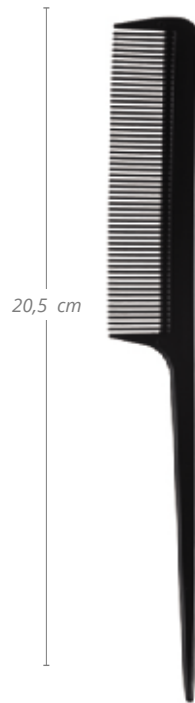

» 5-Zinken Kamm Stahl  
 » Pettine con 5 punte in metallo

REF.00461



» Nadelstielkamm  
 » Pettine con punta in metallo

REF.00460



**Set mit 9 professionellen Friseurkämmе Nylon**  
**Set di 9 pettini da parrucchiere professionali, nylon**



» Enthält 9 professionelle und farbige Kämmе  
 » Include 9 pettini colorati professionali

REF.03928/99

REF. 00453  
 REF. 00454  
 REF. 01469  
 REF. 00423  
 REF. 00441  
 REF. 00115  
 REF. 00116  
 REF. 00118  
 REF. 00422



**Professioneller Kammkoffer**  
**Astuccio per pettini professionali**10  
u.m.vta10  
box» Enthält 6 professionelle Kämme  
» Include 6 pettini professionali

REF.00950

» Enthält 4 professionelle Kämme und eine  
Skelettbürste  
» Include 4 pettini colorati professionali e una  
Spazzole scheletro

REF.00951

REF. 00114  
REF. 00115  
REF. 00116  
REF. 00118  
REF. 00128  
REF. 00136/50REF. 00114  
REF. 00115  
REF. 00136/50  
REF. 00404/50  
REF. 00550/50**Profi-Friseurset, Nylon**  
**Set professionale da parrucchiere, nylon**» Enthält 9 professionelle Kämme  
» Include 9 pettini professionali6  
u.m.vta6  
box

REF.03928

REF. 00114  
REF. 00115  
REF. 00116  
REF. 00180/50  
REF. 00404/50  
REF. 00136/50  
REF. 00118  
REF. 01977  
REF. 00962**Professionelles Friseur-Werkzeugset**  
**Set di strumenti professionali per parrucchieriprofissional**» Enthält 9 professionelle Werkzeuge  
» Include 9 strumenti professionali6  
u.m.vta6  
box

REF.04347

REF. 00114  
REF. 00115  
REF. 00116  
REF. 00180/50  
REF. 00404/50  
REF. 00136/50  
REF. 00118  
REF. 01977  
REF. 00962

**PEGASUS-Schneidekamm**  
**Pettini da taglio PEGASUS**



- » Kunststoffkämme
- » Handgemacht
- » Antistatisch

- » Pettini in plastica
- » Fatti a mano
- » Antistatici

REF. 04242



REF. 04245



- » Kamm zum Schneiden
- » Pettine da taglio

REF. 04249

- » Spezielle Zinken
- » Punta speciale

REF. 04246

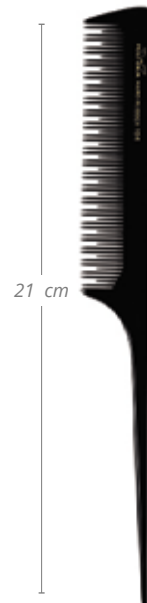



**Schachtel mit 12 Stück Fingerkamm****Confezione da 12 unità di pettini districanti**

Pollié

1  
u.m.vta40  
box» 5 Zinken  
» 5 punte

Pollié 334

REF.01886

» 5 Zinken  
» 5 punte

Pollié 351

REF.01887

» 5 Metallzinken  
» 5 punte in metallo

Pollié 309

REF.01885

**Schachtel mit 12 Stück Nadelstielkamm****Confezione da 12 unità di pettini con punta**1  
u.m.vta40  
box

Pollié 307

REF.01884

1  
u.m.vta50  
box

Pollié 308

REF.01883

» Stahlspitze  
» Punta in metallo1  
u.m.vta40  
box

Pollié 310

REF.01882



## Schachtel mit 12 Stück Schneidekamm Confezione da 12 unità di pettini da taglio

» Nylon  
» Nylon

1 u.m.vta  
40 box

Pollié 310

REF.01876



» Nylon  
» Nylon

1 u.m.vta  
40 box

Pollié 338

REF.01877



» Nylon  
» Nylon

1 u.m.vta  
40 box

Pollié 339

REF.01878



» Spezial  
» Speciale

1 u.m.vta  
50 box

Pollié 306

REF.01879

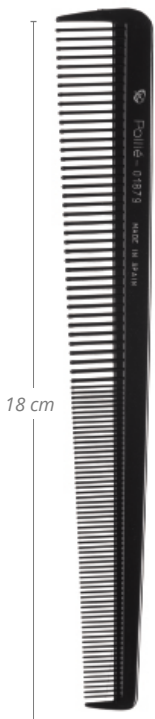

» Spezial  
» Speciale

1 u.m.vta  
40 box

Pollié 302

REF.01880

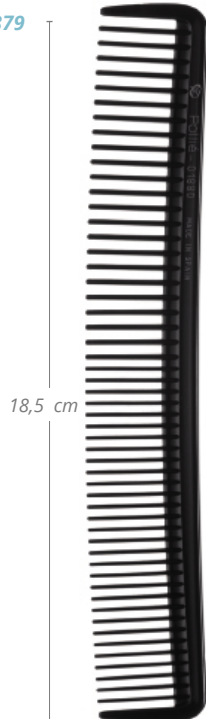

» Nylon  
» Nylon

1 u.m.vta  
50 box

Pollié 305

REF.01881



» Nylon  
» Nylon

1 u.m.vta  
50 box

Pollié 304

REF.01875



**MATADOR-Frisierkamm**  
**Pettini MATADOR**
**MATADOR**  
 PROFESSIONAL
1  
u.m.vta12  
box
 » Mit Griff  
 » Con manico

2607/9

REF. 02607

 » Mit P.A.-Griff  
 » Con manico P.A.

2607/9G

REF. 01638

2206/9

REF. 02206

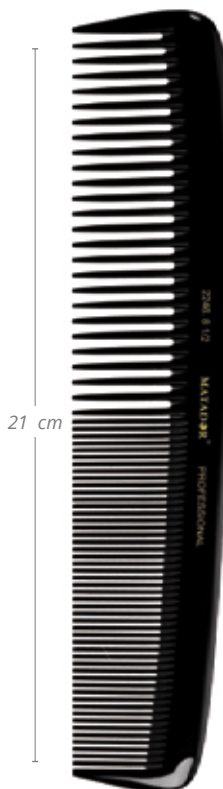

2246/8,5

REF. 02246



2246/7,5

REF. 01637



2255/7

REF. 02255

## MATADOR-Frisierkamm

### Pettini MATADOR

**MATADOR**  
PROFESSIONAL



1  
u.m.vta

12  
box

» Spezial  
» Speciale

2660/7,25

REF. 02660

» Mit P.A.-Griff  
» Con manico P.A.

2677/7

REF. 02331

» Mit P.A.-Griff  
» Con manico P.A.

2211/7

REF. 02211

18,5 cm



18 cm



18 cm



» Breiter  
» Largo

2689/6,5

REF. 02689

» Spezial-Kamm  
» Punta speciale

2614/7T

REF. 01639

» Schneidekamm  
» Pettine da taglio

2614/7

REF. 02614

» Schneidekamm  
» Pettine da taglio

2605/7

REF. 02330

23 cm



17,5 cm



17,5 cm



18 cm



**MATADOR-Kämme**  
**Pettini MATADOR**

 » 8,5P-Zinkenstiel  
 » Punta 8,5P

391/8G

REF. 01654

 » Spezial-  
 Zinkenstiel 8  
 » Punta speciale 8

391/8FT

REF. 01653

385/8,5G

REF. 01649

 » Metallnadelstielkamm  
 » Punta in metallo

386/8,5G

REF. 01652



**Wollen Sie mehr über die Ursprünge der Marke MATADOR erfahren?**  
**Vuoi saperne di più sulle origini del marchio MATADOR?**

**Professionelle Silkomb-Kämme**  
**Pettini professionali Silkomb**

**SILKOMB**



1  
u.m.vta

12  
box

PRO-10

REF. 01520

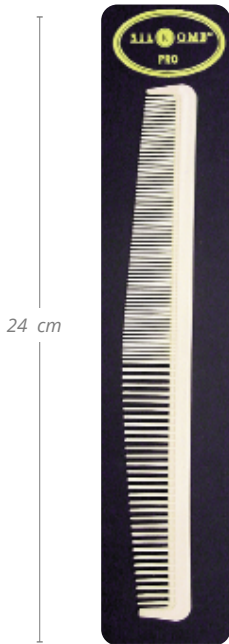

24 cm

PRO-11

REF. 01521



17,5 cm

PRO-20

REF. 01522



19 cm

PRO-30

REF. 01523



19 cm

PRO-40

REF. 01524



23 cm

PRO-50

REF. 01525



22,5 cm

**Farbiger Frisierkamm**  
Pettini districanti colori assortiti12  
u.m.vta48  
box

M

REF. 00138



S

REF. 00400



L

REF. 00448

» Breiter Zinkenstiel  
» Denti larghi

L

REF. 00412



S

REF. 00408

» Gebogener Zinkenstiel  
» Denti larghi

**Frisierkamm**  
**Pettini districanti**

- » Gebogener Frisierkamm, groß
- » Pettine districante denti curvi, grande



REF. 00407

- » Frisierkamm mit Gummigriff
- » Pettine districante con manico in gomma

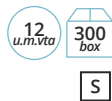

REF. 00425

**Gerader Schneidekamm**  
**Pettine da taglio dritto**

S

REF. 00111

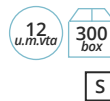

S

REF. 00111/50



L

REF. 00444

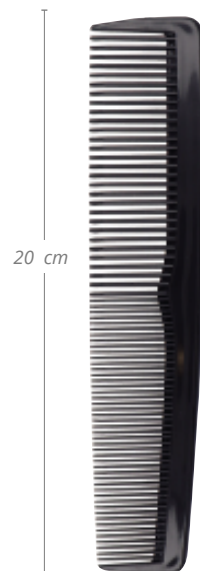



**Schneidekamm**  
**Pettini da taglio**» Doppelter Zinken  
» Denti doppi12  
u.m.vta 48  
box

REF. 00435

» Farbige Strähnen  
» Pettine separatore colorato12  
u.m.vta 60  
box

REF. 00427



18 cm



18 cm

» Strähnen  
» Pettine per meches12  
u.m.vta 60  
box

REF. 00471

» Gewelltes Haar  
» Capelli mossi12  
u.m.vta 60  
box

REF. 00420

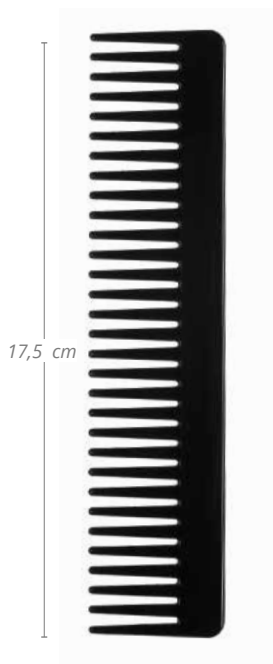

17,5 cm

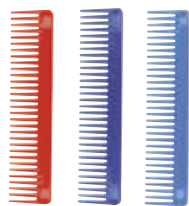

18 cm



**Farbiger Fingerkamm**  
*Pettine districante colori assortiti*

S

REF. 00419

Transparent  
Trasparente  
REF. 00419/56

L

REF. 00426

**Stufenkamm-Strähnen**  
*Pettine scalato per meches*

REF.00421



**Dose mit 60 farbigen Toupinkämme**  
**Barattolo 60 pettini colorati per cotonare**

2  
u.m.vta

2  
box

- » Kunststoffzinken
- » Punte in plastica

MOD. 00423

- » Metallic Farben
- » Colori metallizzati

MOD. 00423

REF.03251

REF.03251/97



**Dose mit 60 Schneidekämme**  
**Barattolo 60 pettini colori assortiti**

- » Kunststoffzinken
- » Punte in plastica

2  
u.m.vta

2  
box

MOD. 00115

REF.03845

- » Metallic Farben
- » Colori metallizzati

2  
u.m.vta

2  
box

MOD. 00115

REF.03845/97



### Dose mit 60 Schneidekämme Barattolo 60 pettini da taglio

- » Kunststoffzinken
- » Punta in plastica

MOD. 00116/99

REF.03250

2  
u.m.vta2  
box

MOD. 00422

REF.03847



### Dose 60 farbige Kämmen barattolo 60 pettini colori assortiti

- » Kunststoffzinken
- » Punta in plastica

2  
u.m.vta2  
box

MOD. 00441

REF.03848

### Dose 24 Toupierbürsten mit doppelter Höhe barattolo 24 spazzole colori assortiti, per cotonare

- » Kunststoffborsten
- » Zwei Höhen

- » Punta in plastica
- » Doppia altezza

1  
u.m.vta20  
box

MOD. 00115

REF.04350



### Dose mit 60 Gabelkämme Barattolo 60 pettini districanti colori assortiti

- » Kunststoffzinken
- » 5 Zinken metallic

- » Punta in plastica
- » 5 punte in metallo



MOD. 00128

REF.03853



### Dose mit 24 Toupierkämme Barattolo da 24 pettini per cotonare colori assortiti

- » Kunststoffzinken
- » 5 Zinken metallic

- » Punta in plastica
- » 5 punte in metallo



MOD. 01469/99

REF.03852



### Dose mit 30 Toupierbürsten Barattolo da 30 spazzole colorate per cotonare

- » Kunststoffborsten
- » Durchscheinende Farben

- » Punta in plastica
- » Colori traslucidi



MOD. 03880

REF.04222



### Dose mit 60 farbigen Kämmen Barattolo da 60 pettini colori assortiti

- » Metallic Zinken
- » Punta in metallo



MOD. 00118

REF.03850



Dose mit farbigen Kämmen · Barattolo pettini, colori assortiti

**Schachtel mit 30 durchsichtigen, sortierten Farbkämme**  
**Barattolo da 30 pettini traslucidi di colori assortiti**

- » Durchsichtige Plastikbox
- » Scatola di plastica trasparente

3  
u.m.vta

3  
box

MOD. 00136

REF.01854



22 cm

**Dose mit 60 Kämmen in verschiedenen durchscheinenden Farben**  
**Barattolo da 60 pettini a colori trasparenti assortiti**

2  
u.m.vta

2  
box

MOD. 00116

REF.01621



19,5 cm

**Dose mit 60 Kämmen in verschiedenen durchscheinenden Farben, ideal zum Toupieren**  
**Barattolo da 60 pettini a colori trasparenti assortiti ideali per cotonare**

2  
u.m.vta

2  
box

MOD. 00423

REF.01625

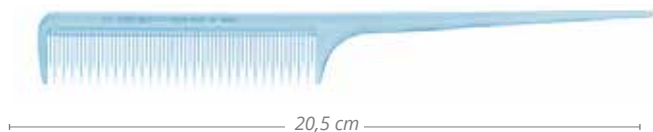
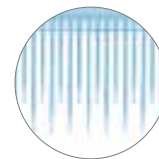

20,5 cm

### Massagebürste Spazzole da massaggio

- » Silikonborsten
- » Punte in silicone

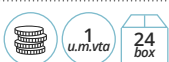

REF.04427



### Dose mit 12 bunten Massagebürsten Barattolo da 12 spazzole colorate per massaggiare

- » Kunststoffbündel
- » Punte in plastica



REF.04403



### Dose mit 24 Mini-Gummibürsten Barattolo da 24 spazzole pneumatiche mini

- » Kunststoffbündel mit Kugeln
- » Setole in plastica, punte arrotondate



REF.02471



### Dose mit 24 Mini-Faltbürsten Barattolo da 24 spazzole pieghevoli mini

- » Kunststoffbündel mit Kugeln
- » Mit Spiegel

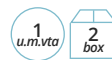

REF.02789



### Holzfarbener Friesierkamm

#### Pettini districanti color legno



» Gebogene Zinken  
» Denti ricurvi

REF. 00408/55

» Gebogene Zinken  
» Denti ricurvi

REF. 00407/55

REF. 00136/55



### Strähnenkamm

#### Pettine per meches



REF. 00409/99

REF. 00409

REF. 00409/50





**Holzfarbene Kämmе**  
**Pettini color legno**

» Strähnschneidekamm  
» Pettine per meches

REF. 00410

» Gabelkamm 5  
Zinken

REF. 00404

» Gabelkamm 5  
gebogene Zinken

REF. 00127

» Pettine per meches

» Pettine districante  
con 5 punte ricurve**Kämmе aus Holz**  
**Pettini in legno**

» Frisierkamm  
» Districante

REF. 04240



» Haarscheidekamm  
» Da taglio

REF. 04241



### Professioneller Fingerkamm

#### Pettine districante afro professionale



REF. 00450

- » Doppelzinken
- » Doppia punta



### Fingerkamm

#### Pettine districante afro



REF. 01852

- » Doppelzinken
- » Doppia punta

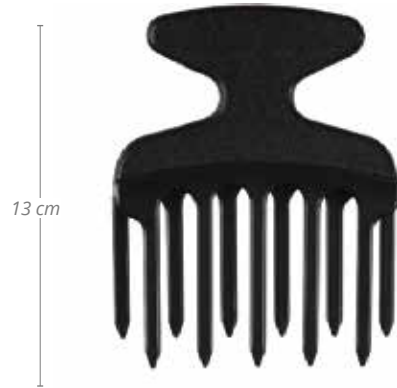

### Fingerkamm

#### Pettine districante afro



- » Großer. Doppelzinken
- » Doppia punta. Grande



REF. 00414

- » Doppelzinken. Klein
- » Doppia punta. Piccolo



REF. 00417



**Mit dem Fingerkamm können Sie eine dicke Toupeierung erzeugen, reichlich und unordentlich, aber mit Stil**

**Con il pettine districante puoi creare una pettinatura spessa, sostanziosa e disordinata, ma elegante**

### Professioneller Fingerkamm

#### Pettine districante professionale

- » Doppelzinken
- » Groß schwarz

- » Doppia punta
- » Extra-large nero



19,5 cm



REF. 00451

- » Doppelzinken
- » Groß farbig

- » Doppia punta
- » Extra-large colorato



19,5 cm



REF. 00434

### Schwarzer Fingerkamm

#### Pettine districante afro

- » Faltbar
- » Pieghevole



REF. 00432

- » 11 Zinken. Mittel
- » 11 punte. Medio



REF. 00402/50

- » 11 Zinken. Groß
- » 11 punte. Grande



REF. 00403/50



19 cm



16,5 cm



17,2 cm

### Fingerkamm aus Holz

#### Pettine districante afro in legno

- » 11 Zinken. Klein
- » 11 punte. Piccolo

REF. 00406

- » 11 Zinken. Mittel
- » 11 punte. Medio

REF. 00402

- » 11 Zinken. Groß
- » 11 punte. Grande

REF. 00403



11 cm



16,5 cm



17,2 cm

**Acetat-Schneidekamm**  
*Pettine da taglio in acetato*



REF. 04236

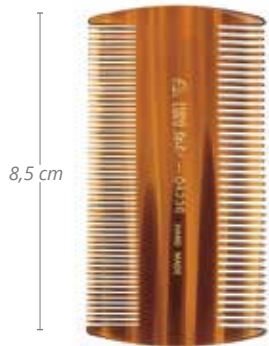

**Muschel/Acetat Schneidekamm**  
*Pettine color tartaruga in acetato*



REF. 04238



REF. 04237

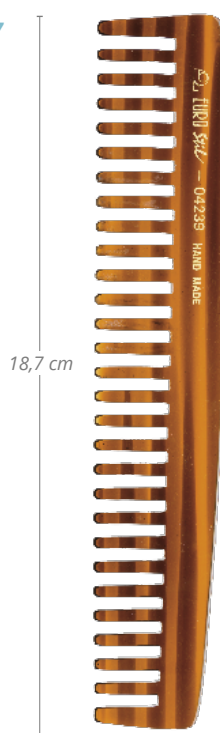

REF. 04239



**Friseurkamm aus Muschel/Acetat**  
**Pettini in acetato per parrucchiere**

REF. 04230

REF. 04231

REF. 04232

REF. 04229

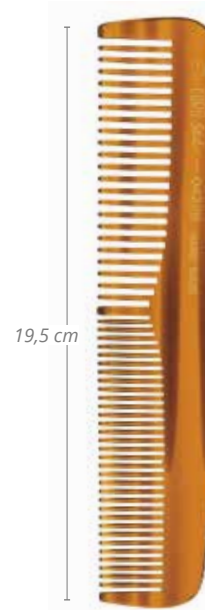
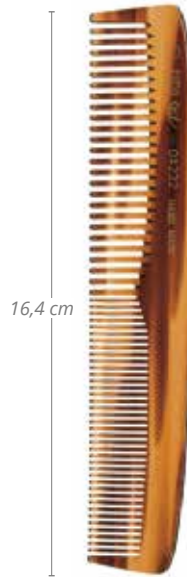
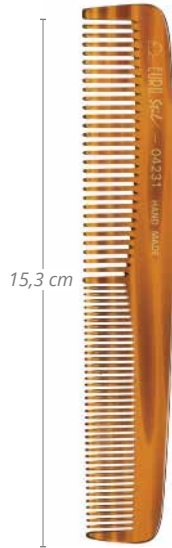
**Verstärkter Muschel/Acetat Schneidekamm**  
**Pettini color tartaruga in acetato rinforzato**

REF. 04233

REF. 04234

» Stahlspeiß  
» Punta in metallo

REF. 04235

» Kamm mit  
» Speiß  
» Muscheleffekt  
» Pettine con punta

REF. 04262

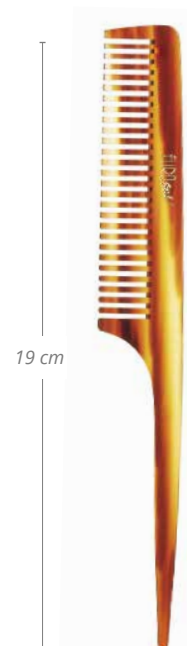
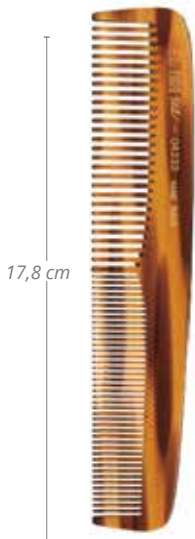

## Muschel/Acetat Kamm

### Pettini color tartaruga in acetato



- » Schneidekamm
- » Acetat
- » Pettine da taglio
- » Acetato



REF. 00177

- » Schneidekamm
- » Acetat
- » Pettine da taglio
- » Acetato



REF. 00178

- » SchneidekammAcetat
- » Pettine da taglio
- » Acetato



REF. 00179

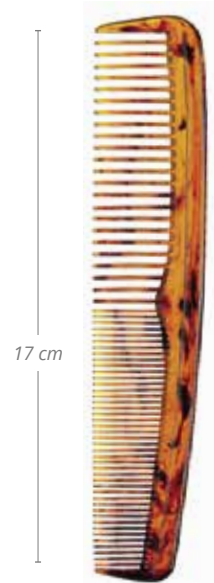
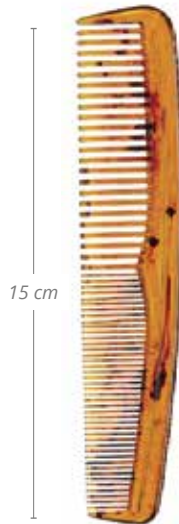
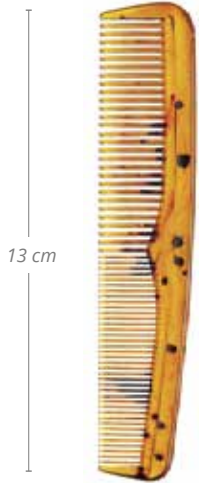

- » SchneidekammAcetat
- » Pettine da taglio
- » Acetato



REF. 00180



REF. 00444/51

- » Frisierkamm
- » Muscheleffekt
- » Pettine districante
- » Tartaruga



REF. 00136/51

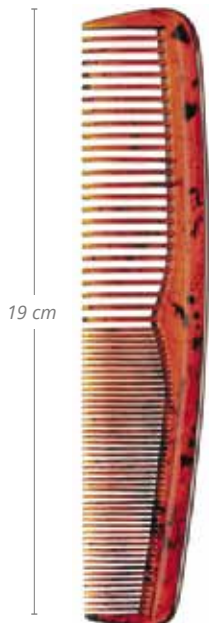

## **DER UMWELT VERPFLICHTET PRODUKTLINIE AUS RECYCELTEM MATERIAL (EIGENE HERSTELLUNG)**

Nachhaltigkeitsstudie für Produkte durch das Unternehmen LEITAT mit dem Hauptziel, eine nachhaltigere Produktlinie zu schaffen

Konkret gesagt reduziert die Schale (Ref. 00655) die globale Umweltauswirkung um 26%, der Pinsel (Ref. 00102) um 28%, der Kamm (Ref. 00136) um 28% und der Kamm (Ref. 00409) um 21%, unter Verwendung von recyceltem Polypropylen.

Recyceltes Polypropylen zu verwenden, ermöglicht die Reduzierung der Umweltwirkungen um 25 bis 28%. Die Rohstoffgewinnung sorgt für 17 bis 37% der Auswirkungen bei mit neuen Polypropylen hergestellten Produkten.



## **IL NOSTRO IMPEGNO PER L'AMBIENTE LINEA DI PRODOTTI IN MATERIALE RICICLATO (PRODUZIONE PROPRIA)**

*Studio sulla sostenibilità dei prodotti realizzato dall'azienda LEITAT come obiettivo principale per creare una linea di prodotti più sostenibile*

*Nello specifico la vaschetta rif.00655 riduce il suo impatto ambientale complessivo del 26%, la spatola rif. 00102 del 28%, il pettine rif. 00136 del 28% e il pettine rif.00409 del 21% con l'utilizzo di polipropilene riciclato.*

*L'utilizzo di polipropilene riciclato riduce l'impatto ambientale tra il 25 e il 28%. Gli impatti dovuti all'ottenimento di materie prime rappresentano tra il 17% e il 37% degli impatti nei prodotti realizzati con polipropilene vergine*

**Verstärkter Acetatschalenschlägerkamm**  
*Pettine a conchiglia in acetato rinforzato*



REF.00136/222



NEW



REF.00409/222



NEW



**Große Palette aus recyceltem Material**  
*Grande pallet di materiale riciclato*



REF.00102/222



NEW



**Große recycelte Plastikschale**  
*Grande ciotola di plastica riciclata*



REF.00655/222



NEW





# Lockenwickler, duttkissen und kopfbedeckungen

BIGODINI,  
CUFFIE,  
RETINE

*Lockenwickler, Dauerwellenwickler,  
Haarnadeln, Schaumlockenwickler,  
Haarnetze, Schutzhauben...*

*Bigodini, forcine, bigodini  
flessibili, retine, cuffie...*



**Beutel 12 Dauerwellenwickler aus geriffeltem Holz**  
**Sacchetto da 12 bigodini permanente in legno**



N° 0

REF.01544



N° 3

REF.01546



N° 5

REF.01548



N° 8

REF.01571



**Beutel 6 Dauerwellenwickler aus Holz**  
**Sacchetto da 6 bigodini permanente in legno**



N° 10

REF.01573



N° 12

REF.01550



### Beutel 10 Lockenwickler aus geriffeltem Holz Sacchetto da 10 bigodini permanente in legno

REF.01559

1 u.m.vta  
160 box

Ø 6



REF.01560

1 u.m.vta  
120 box

Ø 8



REF.01561

1 u.m.vta  
90 box

Ø 10



REF.01562

1 u.m.vta  
60 box

Ø 12



### Beutel 12 Dauerwellenwickler Sacchetto da 12 bigodini permanente

12 u.m.vta  
12 box

» Kunststoff, zweifarbig gewellt

» Plastica, bicolore ondulato

REF.01500

Ø 7,5

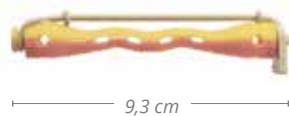

REF.01501

Ø 8,5

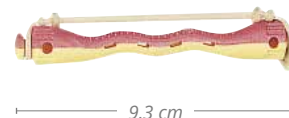

REF.01502

Ø 10

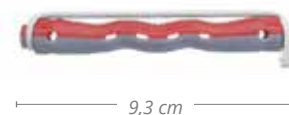

REF.01503

Ø 12



REF.01504

Ø 16

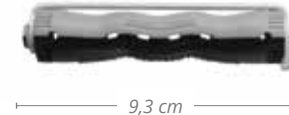

### Beutel 100 Dauerwellenwickler Sacchetto da 100 bigodini permanente

» Kunststoff

» Plastica

1 u.m.vta  
36 box

REF.01554

N° 1

Ø 7,8



REF.01555

N° 2

Ø 8,9



REF.01556

N° 3

Ø 10



REF.01557

N° 4

Ø 12



REF.01558

N° 5

Ø 14



## Beutel 12 geriffelte Kunststofflockenwickler Sacchetto da 12 bigodini in plastica scanalata

1 u.m.vta  
24 box



5,9 cm

REF.01239

» Inklusive einer Tasche mit Haarnadeln  
» Include un sacchetto con forcine



5,9 cm

REF.01241



5,9 cm

REF.01242



5,9 cm

REF.01243



## Inklusive einer Tasche mit Haarnadeln Sacchetto da 50 elastici per bigodini

» Flach  
» Lang

» Piatti  
» Lunghi

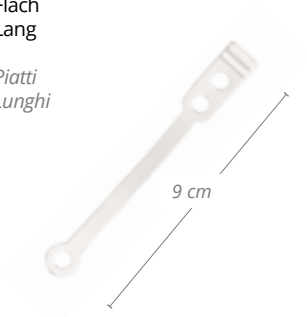

12 u.m.vta  
12 box

REF.00864

» Rund  
» Lang

» Rotondi  
» Lunghi

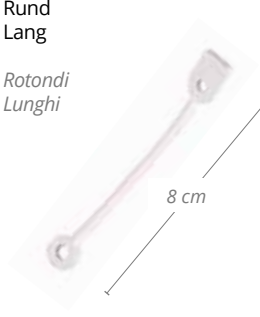

12 u.m.vta  
12 box

REF.00862

» Silikon  
» Kurz

» In silicone  
» Corti



1 u.m.vta  
50 box

REF.01490

» Flach  
» Kurz

» Piatti  
» Corti

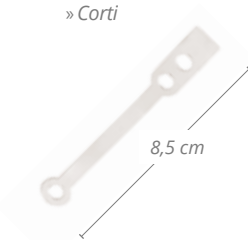

12 u.m.vta  
12 box

REF.00865

» Rund  
» Kurz

» Rotondi  
» Corti

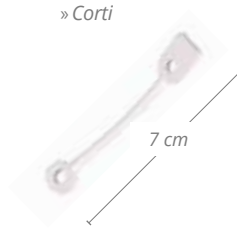

12 u.m.vta  
12 box

REF.00863

**Ringe Dauerwellenwickler 100 gr**  
**Sacchetto da 100gr di elastici per bigodini**

REF.00653



Für Dauerwellenwickler aus Holz  
 Per bigodini di legno

**Beutel mit 50 Ersatzgummis**  
**Sacchetto da 50 elastici di ricambio**

REF.00867



Für Dauerwellenwickler aus Holz  
 Per bigodini di legno

**Beutel 12 Plastik-Dauerwellenwickler**  
**Sacchetto da 12 bigodini permanente in plastica**

REF.00900

- » Große Version
- » Kunststoff
- » Zweifarbig
- » Lunghi
- » Plastica
- » Bicolore



REF.00901



REF.00902



REF.00903

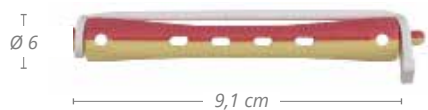

REF.00904

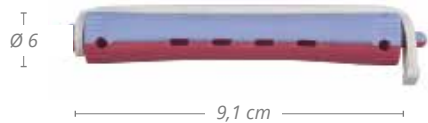

REF.00905

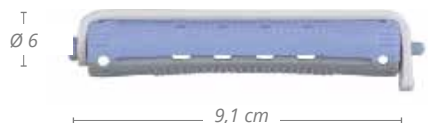

REF.00906

**Beutel 12 Plastik-Dauerwellenwickler**  
**Sacchetto da 12 bigodini permanente in plastica**

REF.00907

- » Kurze Version
- » Kunststoff
- » Zweifarbig
- » Lunghi
- » Plastica
- » Bicolore



REF.00908



REF.00909



REF.00910



REF.00911



REF.00912



REF.00913



**Lange und kurze Schaumlockenwickler: 12 Stück**  
**Bigodini flessibili lunghi e corti: 12 unità**



**Lang**  
Lunghi

**Kurz**  
Corti

REF. 01244

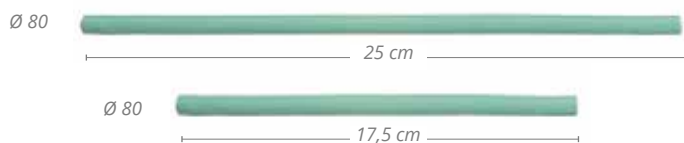

REF. 01251

REF. 01245

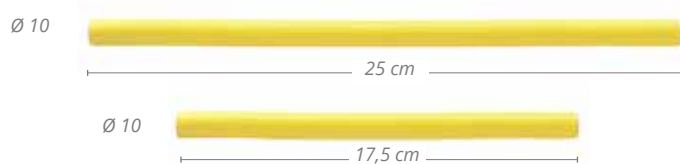

REF. 01252

REF. 01246

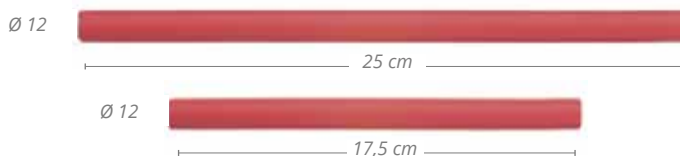

REF. 01253

REF. 01247

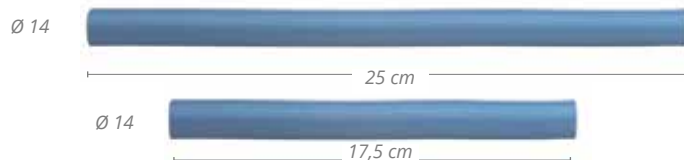

REF. 01254

REF. 01248

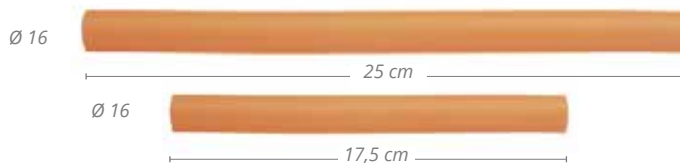

REF. 01255

REF. 01249

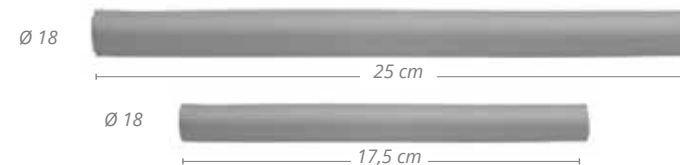

REF. 01256

REF. 01250



REF. 01257

**Beutel 6 lockenwickler draht**  
**Sacchetto da 6 rulli in rete**



» Blau  
 » Blu



Ø 10

NEW

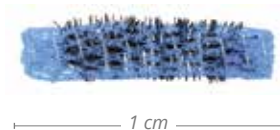

1 u.m.vta 12 box

6 u

REF. 07333

» Rosa  
 » Rosa



Ø 13

NEW

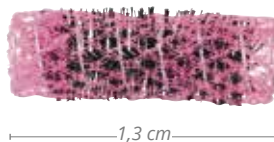

1 u.m.vta 12 box

6 u

REF. 07334

» Lila  
 » Viola



Ø 17

NEW

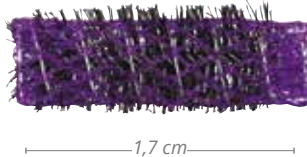

1 u.m.vta 12 box

6 u

REF. 07335

» Rosa  
 » Rosa



Ø 22

NEW

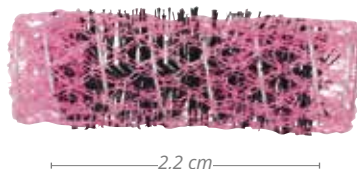

1 u.m.vta 12 box

6 u

REF. 07336

**Beutel 6 lockenwickler draht schwarz**  
**Sacchetto da 6 rulli in rete nera**



NEW

Ø 28



2,8 cm

1  
u.m.vta12  
box

6 u

REF. 07337



NEW

Ø 32



3,2 cm

1  
u.m.vta12  
box

6 u

REF. 07338



NEW

Ø 36



3,6 cm

1  
u.m.vta12  
box

6 u

REF. 07339



NEW

Ø 45



4,5 cm

1  
u.m.vta12  
box

6 u

REF. 07340



## Beutel mit Klettwickler Sacchetto bigodini adesivi



» Grün  
» Verdi

1 u.m.vta 80 box  
9 u

REF. 00015

Ø 23

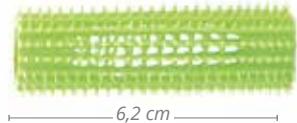

6,2 cm

» Orange  
» Arancioni

1 u.m.vta 70 box  
8 u

REF. 00016

Ø 27

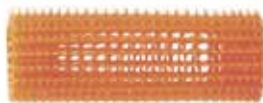

6,2 cm

» Gelb  
» Gialli

1 u.m.vta 45 box  
8 u

REF. 00017

Ø 31



6,2 cm

» Rot  
» Rossi

1 u.m.vta 40 box  
6 u

REF. 00018

Ø 39



6,2 cm

» Blau  
» Blu

1 u.m.vta 25 box  
5 u

REF. 00047

Ø 45

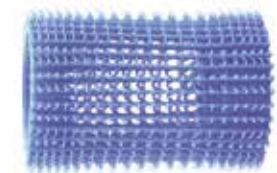

6,2 cm

» Lila  
» Viola

1 u.m.vta 20 box  
5 u

REF. 00024

Ø 55

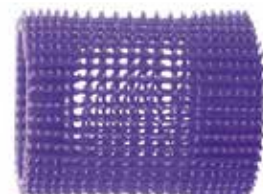

6,2 cm

## Klettwickler-Kit 60 Stück Kit arricciacapelli 60 rotoli

» Rosa  
» Rosa

1 u.m.vta 16 box  
4 u

REF. 00025

Ø 65



6,2 cm

» 12 Klettwickler in 5 Größen  
» 12 rotoli per 5 misure

1 u.m.vta 12 box  
60 u

REF. 04428



### Beutel mit Heißwickler Confezione di bigodini termici

Achtung, nicht in der Mikrowelle verwenden  
Attenzione, non scaldare nel microonde



» Klein  
» Piccoli

6 u

REF. 00019

» Klein  
» Medi

6 u

REF. 04024

» Groß  
» Grandi

5 u

REF. 00020

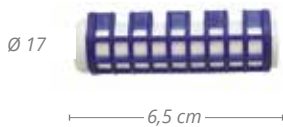

### Schachtel mit Heißwickler Confezione di bigodini termici

Achtung, nicht in der Mikrowelle verwenden  
Attenzione, non scaldare nel microonde



» Klein  
» Piccoli

6 u

REF. 03391

» Klein  
» Medi

6 u

REF. 03392

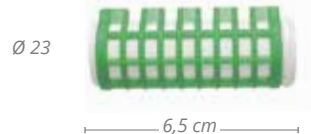

» Groß  
» Grandi

5 u

REF. 03393

» Groß  
» Grandi

4 u

REF. 03394



### Beutel mit 12 Schaumrollenwickler Confezione da 12 bigodini gommaspugna



» Blau  
» Blu

REF. 04019



### Beutel mit 12 Schaumrollenwickler Confezione da 12 bigodini gommaspugna



» Grün  
» Verdi

REF. 04021



» Gelb  
» Gialli

REF. 04020



» Rosa  
» Rosa

REF. 04023



**Beutel mit 12 Lockenwickler in durchsichtigem Rosa**  
**Sacchetto da 12 bigodini super aderenti**



12  
u.m.vta

120  
box

N°0

REF. 00000



12  
u.m.vta

72  
box

N°1

REF. 00001

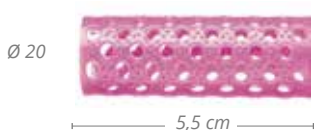

12  
u.m.vta

240  
box

N°2

REF. 00002



12  
u.m.vta

144  
box

N°3

REF. 00003



12  
u.m.vta

120  
box

N°4

REF. 00004



12  
u.m.vta

72  
box

N°5

REF. 00005



12  
u.m.vta

60  
box

N°6

REF. 00006

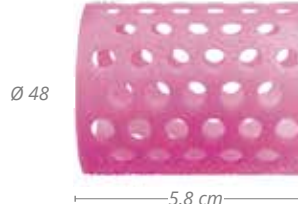

12  
u.m.vta

48  
box

N°7

REF. 00007



12  
u.m.vta

24  
box

N°8

REF. 00008

**Die bei Industrias Oriol hergestellten rosa Lockenwickler sind ein Klassiker ihrer Firmengeschichte und sind über die Jahre immer hoch geschätzt.**

*I rulli rosa prodotti da Industrias Oriol sono un classico molto apprezzato in tutti gli anni della storia dell'azienda.*



**Beutel mit 12 extra starken Lockenwickler (einschließlich Beutel mit Haarnadeln)**  
**Sacchetto da 12 bigodini super aderenti (include sacchetto con forcine)**

1  
u.m.vta

12  
box

» Speziell für Afro-Haar und widerstandsfähiges Haar  
 » "Speciale" per capelli afro e capelli resistenti



REF. 04665

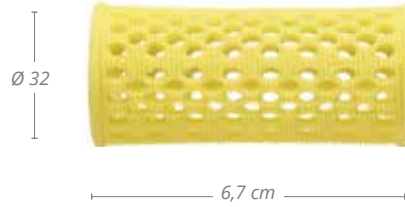

REF. 04666

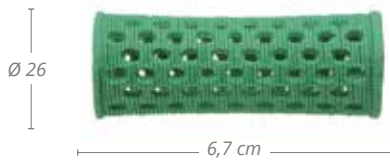

REF. 04667

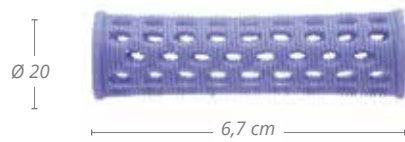

REF. 04668

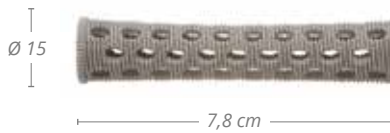

REF. 04669



REF. 04670



**Beutel mit 6 Klettwicklern extra stark**  
**Sacchetto da 6 bigodini super adesivi**

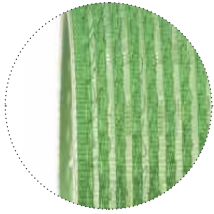

Ø 13



6 cm

REF.00009

Ø 15



6 cm

REF.00031

Ø 21



6 cm

REF.00010

Ø 24



6 cm

REF.00011

Ø 28



6 cm

REF.00012

Ø 32



6 cm

REF.00013

Ø 36



6 cm

REF.00014

**Beutel mit 3 Klettwicklern extra stark**  
**Confezione da 3 bigodini super adesivi**

Ø 40



6 cm

REF.00028

Ø 44



6 cm

REF.00032

Ø 48



6 cm

REF.00033

Ø 60



6 cm

REF.00034

**Beutel mit 12 Klettwicklern extra stark (Farben können variieren)**  
**Sacchetto da 12 bigodini adesivi (i colori possono variare)**



REF. 04003



REF. 04006

**Beutel mit 6 Klettwicklern extra stark**  
**Sacchetto da 6 bigodini adesivi**



REF. 04007

**Beutel mit Haarnadeln**  
**Confezione di forcine**

- » Metall
- » Lang

- » Metallo
- » Lunghe

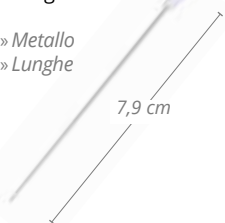

100 u

REF. 01495

- » Haarspieß
- » Forcine a spillo



36 u

REF. 00649

- » Nylon
- » Nylon



36 u

REF. 00648

**Schachtel mit Haarnadeln**  
**Scatola per forcine**

- » Nylon
- » Nylon

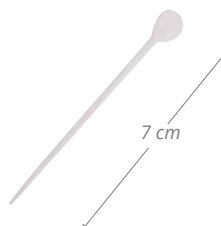

300 u

REF. 03329

## Haarnetz ohne Band für die Nacht Retina senza nastro

12  
u.m.vta

12  
box

» Schwarz  
» Nero

REF.01049/50

» Dunkelbraun  
» Castano scuro

REF.01049/67



» Natürliches Kastanienbraun  
» Castano naturale

REF.01049/76

» Hellbraun  
» Castano chiaro

REF.01049/65

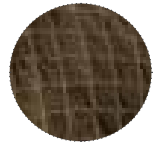

» Rosa  
» Rosa

REF.01049/70

» Blau  
» Blu

REF.01049/59

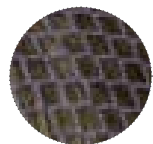

### Dreieckstuch Netz zum Trocknen

#### Retine asciugatura triangolare



» Elastisch  
» *Elastica*

90 x 72 x 72 cm

» Großmaschig mit Band  
» *Con bordo*

80 x 70 x 70 cm



REF.01044/50 REF.01044/59



REF.01042/59 REF.01042/68



REF.01044/69 REF.01044/70

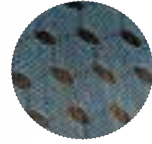

REF.01042/69

» Ohne Band  
» *Senza bordo*

83 x 74 x 74 cm

» Mit Band  
» *Con bordo*

83 x 74 x 74 cm



REF.01039/50 REF.01039/59



REF.01041/50 REF.01041/59



REF.01039/69 REF.01039/70



REF.01041/69 REF.01041/70

### Haarnetz für die Nacht

#### Cuffia da notte



» Mit Band  
» *Retina notte*

REF.01048/50 REF.01048/59

» Nylon  
» Verschiedene Farben

REF.01053

» Nylon  
» Assortimento di colori



REF.01048/69 REF.01048/70





### Haarnetz für die Nacht Cuffia da notte

12  
u.m.vta

60  
box

» Nylon  
» Nylon

REF.01539

» Nylon-Haarnetz mit Band  
» Cuffia da notte in nylon con nastro

REF.01538

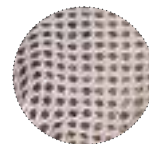
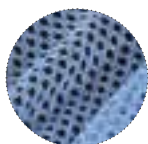

### Duschhaube Cuffia doccia

» Bedruckt  
» Colorata

12  
u.m.vta

60  
box

REF.01542

» Kunststoff  
» Wiederverwendbar 3 Stück

12  
u.m.vta

12  
box

REF.00967

» Plastica  
» Permanente 3 unità

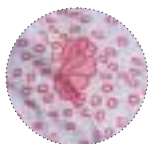

12  
u.m.vta

12  
box

REF.01227

REF.01227/58

» Einweg (Duschhaube)  
» Monouso

200  
u.m.vta

200  
box

REF.01540



### Beutel mit Strähnenhauben Confezione di cuffie per meches



- » Zweischichtig
- » Doppio strato

5 u

REF. 01290

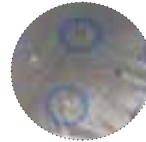

- » Schwarzer Keder
- » Bordo nero



10 u

REF.02532/50



- » Mit Haken
- » Bordo nero



50 u

REF.00973

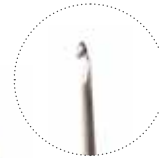

### Strähnenhaube Cuffie per meches

- » Kunststoff
- » Ohne Löcher

- » Plastica
- » Senza fori



REF.00965



- » Gummi
- » Braun

- » Gomma
- » Marrone



REF. 00896



## Strähnenhaube Cuffie per meches

- » Durchscheinend mit Strähnennadel
- » *Traslucida con uncinetto*



REF. 02196

- » Durchscheinend mit Strähnennadel
- » *Accessori*



REF. 03402



- » Perforiertes Silikon mit Strähnennadel
- » *Cuffie mèches in silicone, con uncinetto*



REF. 06460



- » Spezial-Silikon
- » *Silicone speciale*



REF. 03729

- » Silikon
- » *In silicone*



REF. 00897

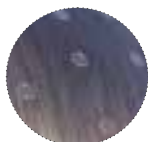

## Strähnenhaube Cuffie per meches



- » Spezial-Gummi
- » Gomma speciale

REF. 00894

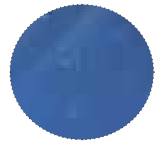

- » Gummi
- » Gomma



REF. 01511

- » Spezial-Gummi
- » Gomma speciale



REF. 01995



### Beutel mit Strähnennadeln Sacchetto di uncinetti



» Medium  
» Medium



6 u

REF. 01266

» 3 Größen  
» 3 misure

3 u

REF. 01265

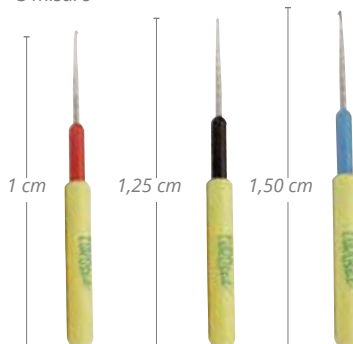

### Spezial-Strähnenkamm Pettine speciale per meches



REF. 00440



### Täschchen mit Strähnennadeln Sacchetto di uncinetti per meches



REF. 01966

» Doppelt  
» Doppì



### Strähnenkamm Metallhorn Pettine con punta in metallo per meches



REF. 00473



**Strähnchen über Hauben sind eine Alternative zum Aufhellen der Haare statt durch Bleichen oder Färben.**  
**Le meches a cuffia sono un'alternativa per dare luce ai capelli, sia sbiancandoli che con tintura.**

## Hauben Cuffia termica

- » Aluminium
- » Alluminio

10  
u.m.vta 10  
box

REF.02534



- » Föhnhauben
- » Cuffia termica per asciugacapelli

6  
u.m.vta 6  
box

REF.03189



- » Kunststoff "MACRO"
- » Plastica - Extra-large

12  
u.m.vta 12  
box

REF.00966



## Haarhaube Textil Cuffia asciugamano

- » Mit Gummi und Knopf
- » Con elastico e bottone

REF. 03404

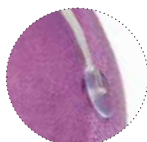

- » Ohne Gummi mit Knopf
- » Senza elastico con bottone

1  
u.m.vta 10  
box

REF. 04433

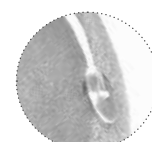

## Unsichtbare Haarnetze

### Retine invisibili

12  
u.m.vta

12  
box

» Nylon  
» Nylon

» Nylon-Dutt  
» Nylon crocchia. Retine per chignon  
invisibili

» Natürliches Haar  
» Capelli naturali



REF.01046/50



REF.01047/50



REF.01045/50



REF.01046/65



REF.01047/65



REF.01045/69



REF.01046/66



REF.01047/66



REF.01045/66



REF.01046/67



REF.01047/69



REF.01046/76



## Duttkissen

### Ciambelle acconciatura



9 gr

Klein · Piccolo

●  
REF. 03001/50



●  
REF. 03001/67

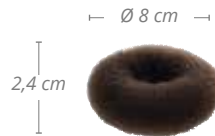

●  
REF. 03001/65



●  
REF. 03001/66



Mittel · Medio

●  
REF. 04435/50



●  
REF. 04435/65



●  
REF. 04435/66





## Duttkissen · Ciambelle acconciatura

## Duttkissen

## Riempimento crocchia circolare



14 gr

REF.01453/50

REF.01453/65

REF.01453/66

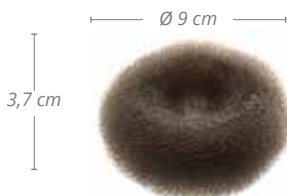
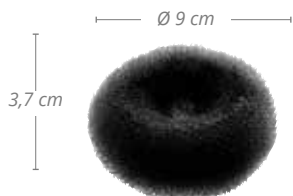
Mittel/Groß  
Medio/grande

Groß · Grande

REF.04436/50

REF.04436/65

REF.04436/66

Extra groß  
Extra grande

REF.04437/50

REF.04437/65

REF.04437/66

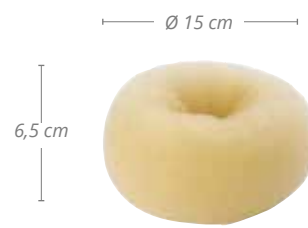

## Duttkissen · Riempimenti

Duttkissen  
Acconciature

14 gr



REF.01454/50



REF.01454/65



REF.01454/66

14 gr



REF. 03002/50



REF. 03002/67



REF. 03002/65



REF. 03002/66

Duttkissen mit Band  
Crespo con elastico

14 gr

REF.04434/50

REF.04434/65

REF.04434/66



## Duttkissen · Ripieno

Duttkissen länglich gross  
Ripieno grande, allungato

52 gr

REF. 03636/50

REF. 03636/65

REF. 03636/66

Duttkissen länglich gross  
Ripieno grande rotondo

20 gr

REF. 03635/50

REF. 03635/65

REF. 03635/66



**Wie wird es gemacht?****Come usare?**

1. Einen Pferdeschwanz machen  
1. *Fai una coda*



2. Den Zopf durch den Ring führen und mit Haarnadeln feststecken  
2. *Passa la coda nel foro e fissala con le forcine*



3. Etwas Haarspray auftragen und das Haar um den Ring wickeln  
3. *Applica un po' di lacca e avvolgi i capelli attorno alla ciambella*



1. Das Duttkissen auf den Kranz setzen  
1. *Posizionare il ripieno sulla punta del capo*



2. Das Kissen befestigen  
2. *Sosteni il ripieno*



3. Das Duttkissen mit den Haaren auf der Vorderseite abdecken und mit Haarnadeln befestigen  
3. *Coprire il ripieno con i capelli della parte anteriore e fissarlo con delle forcine*

# Rasiermesser und Haarschneidescheren

RASOI E FORBICI

*Haarschneidescheren, Etuis...  
Forbici, astucci...*



### EXCELSIOR Profi-Schere

#### Forbici professionali EXCELSIOR

1 u.m.vta 10 box

5,5"

REF.04900



» Schnitt  
» Da taglio

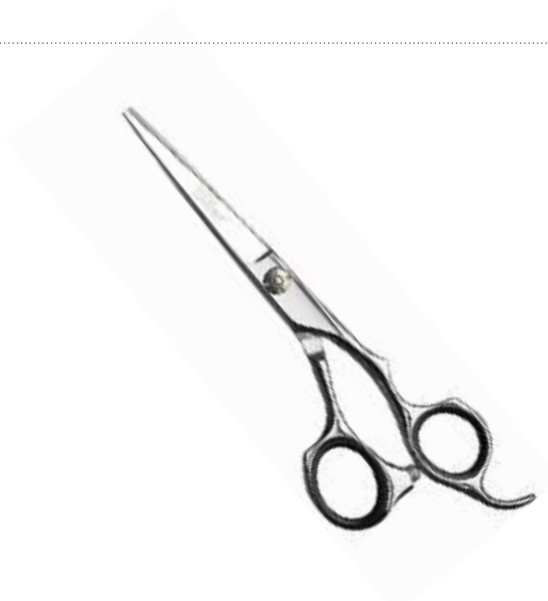

» Werkstoff: Japanischer  
Stahl V610  
» Härte: 63 HRC  
» Rand: konvex

» Materiale: acciaio  
giapponese V610  
» Durezza: 63HRC

### INFINITY-Schere

#### Forbici INIFINITY

» Werkstoff: Stahl 440C  
» Härte: 59-61 HRC

» Materiale: acciaio 440C  
» Durezza: 59-61 HRC

1 u.m.vta 10 box



» Beinhaltet: Öl, Ledertuch, Gummiringe und  
Schraubenschlüssel

» Include: olio, anelli di gomma e chiave per  
stringere

» Schnitt  
» Da taglio

5,5"

REF.06976



» Schnitt  
» Da taglio

6"

REF.06977



» Modellier  
» Per sfoltire

6"

REF.06978





» Beinhaltet: Öl, Ledertuch,  
Gummiringe und Schraubenschlüssel

» Include: olio, anelli di gomma e chiave  
per stringere

### AMATIST-Schere Forbici AMATIST

» Werkstoff: Stahl 440C  
» Härte: 59-61 HRC

» Materiale: acciaio 440C  
» Durezza: 59-61 HRC

1 u.m.vta  
10 box

» Schnitt  
» Da taglio

5,5"

REF.06970

» Schnitt  
» Da taglio

6"

REF.06971

» Modellier  
» Per sfoltire

6"

REF.06972



### OASIS-Schere Forbici OASIS

» Werkstoff: Stahl 440C  
» Härte: 59-61 HRC

» Materiale: acciaio 440C  
» Durezza: 59-61 HRC

1 u.m.vta  
10 box

» Schnitt  
» Da taglio

5,5"

REF.06973

» Schnitt  
» Da taglio

6"

REF.06974

» Modellier  
» Per sfoltire

6"

REF.06975





- » Stahl 440
- » Rasiermesserscharf
- » Oberfläche unregelmässig
- » Hohe Härte 59,61 HRC
- » Einstellschrauben
- » Individuelles Etui

- » Acciaio 440
- » Affilatura a rasoio
- » Finitura manuale
- » Durezza 59,61 HRC
- » Viti di regolazione
- » Custodia individuale

**EURO** *stil*  
PROFESSIONAL

### SHARK Schere Forbici SHARK

- » Schnitt
- » Da taglio

5,5"

REF. 04627

- » Modellier
- » Per sfoltire

5,5"

REF. 04628



### PIRATE-Schere Forbici PIRATA

- » Schnitt
- » Da taglio

5,5"

REF. 04630

### DARK Schere Forbici DARK

- » Schnitt
- » Da taglio

5,5"

REF. 04629



### Scherenhalter-Musterkoffer Astuccio porta-forbici

- » 6 Stück
- » 6 unità



REF. 04633





## Scheren · Forbici

**ATHENA-Schere**  
**Forbici ATENEA**

» Werkstoff: martensitischer Stahl 420J2  
 » Härte: 56HRC

» Materiale: acciaio inossidabile 420J2  
 » Durezza: 56HRC

1  
u.m.vta

12  
box

» Nicht enthalten: Öl, Ledertuch, Gummiringe und Schraubenschlüssel

» Non include: olio, anelli di gomma o chiave per stringere

» Schnitt  
 » Da taglio

5,75"

REF.07020/68

» Modeller  
 » Per sfoltire

5,75"

REF.07021/68



» Schnitt  
 » Da taglio

5,75"

REF.07020

» Modeller  
 » Per scolpire

5,75"

REF.07021

» Schnitt  
 » Da taglio

5,75"

REF.07020/70

» Modeller  
 » Per sfoltire

5,75"

REF.07021/70

**AFRODITA-Schere**  
**Forbici AFRODITA**

Werkstoff: Stahl 440C  
 Härte: 59-61 HRC

» Materiale: acciaio 440C  
 » Durezza: 59-61 HRC

1  
u.m.vta

12  
box

» Nicht enthalten: Öl, Ledertuch, Gummiringe und Schraubenschlüssel

» Non include: olio, anelli di gomma o chiave per stringere

» Schnitt  
 » Da taglio

6"

REF.07022/70

» Schnitt  
 » Da taglio

6"

REF.07022





» Nicht enthalten: Öl, Ledertuch, Gummiringe und Schraubenschlüssel

» Non include: olio, anelli di gomma o chiave per stringere

### ISIS-Schere Forbici ISIS

Werkstoff: martensitischer Stahl 420J2  
Härte: 56 HRC

» Materiale: acciaio inossidabile 420J2  
» Durezza: 56HRC



» Schnitt  
» Da taglio

6"

REF.07023



» Modellier  
» Per sfoltire

6"

REF.07024



» Schnitt  
» Da taglio

6"

REF.07023/70



» Modellier  
» Per sfoltire

6"

REF.07024/70



### MINERVA-Schere Forbici MINERVA

Werkstoff: martensitischer Stahl 420J2  
Härte: 56HRC

» Materiale: acciaio inossidabile 420J2  
» Durezza: 56HRC



» Schnitt  
» Da taglio

6"

REF.07026



» Modellier  
» Per sfoltire

6"

REF.07025



» Schnitt  
» Da taglio

6"

REF.07026/70



» Modellier  
» Per sfoltire

6"

REF.07025/70



## Scheren · Forbici

**ECLIPSE-Schere**  
**Forbici ECLIPSE**Werkstoff: martensitischer Stahl 420J2  
Härte: 56HRC» Materiale: acciaio inossidabile 420J2  
» Durezza: 56HRC1  
u.m.v.a  
12  
box» Nicht enthalten: Öl, Ledertuch, Gummiringe  
und Schraubenschlüssel» Non include: olio, anelli di gomma o chiave  
per stringere» Schnitt  
» Da taglio

6"

REF.07027/68

» Modellier  
» Per sfoltire

6"

REF.07054/68

» Schnitt  
» Da taglio

6"

REF.07027

» Modellier  
» Per sfoltire

6"

REF.07054

» Schnitt  
» Da taglio

6"

REF.07027/70

» Modellier  
» Per sfoltire

6"

REF.07054/70



### Stahlscheren WAVES

#### Forbici da taglio WAVES

1 u.m.vta  
12 box

» Schnitt  
» Da taglio

6"

REF.04316



» Modellier  
» Per sfoltire

5,75"

REF.04317



### Professionelle Schere ERGO

#### Forbici professionali ERGO

1 u.m.vta  
12 box

» Schnitt  
» Da taglio

6"

REF.04314



» Modellier  
» Per sfoltire

6"

REF.04315



### RUBI Profi-Schere

#### Forbici professionali RUBI

1 u.m.vta  
12 box

» Schnitt  
» Da taglio

5"

REF.04319



» Modellier  
» 25 Zähne

5,5"

REF.04401

» Per sfoltire  
» 25 denti



### WILL-Messerklingschere mit Fingerauflage

Forbici con affilatura a rasoio con stanghetta WILL



» Schnitt  
» Da taglio

5,5"

REF. 04707

» Schnitt  
» Da taglio

6"

REF. 04708

» Modellier  
» Per sfoltire

6"

REF. 04709



### Messerschere für Linkshänder

Forbici con affilatura a rasoio per MANCINI

» Schnitt  
» Da taglio

5,5"

REF.04503

» Modellier  
» Per sfoltire

5,5"

REF.04504

### Schere für Linkshänder

Forbici speciali per MANCINI

» Schnitt  
» Da taglio

5,5"

REF.02213



**Scheren COSMOS LINE**  
**Forbici COSMOS LINE**

Werkstoff: martensitischer Stahl 4cr  
Härte: 51-52 HRC. - Oberfläche: matt  
Abnehmbare Fingerauflage. Konvexe Klinge

» Materiale: acciaio inossidabile 4cr  
» Durezza: 51-52Hrc - finitura: opaca  
» Poggiadito rimovibile.



» Schnitt  
» Da taglio

5,5"

REF.06815



» Schnitt  
» Da taglio

6"

REF.06816



» Modellier  
» Per sfoltire

6"

REF.06817

**EVOLUTE-LINE-Schere**  
**Forbici EVOLUTE LINE**

Werkstoff: martensitischer Stahl 4CrNEW  
Härte: 51-52 HRC- Oberfläche: matt  
Abnehmbare Fingerauflage. Konvexe Klinge

» Materiale: acciaio inossidabile 420  
» Durezza: 51-52HRC - finitura: opaca  
» Poggiadito rimovibile.



» Schnitt  
» Da taglio

5,5"

REF.07101



» Schnitt  
» Da taglio

6"

REF.07102



» Modellier  
» Per sfoltire

6"

REF.07103

**UTILE LINE-Schere**  
**Forbici UTILE LINE**

» Werkstoff: martensitischer Stahl 4Cr  
» Härte: 51-52 HRC- Oberfläche: matt  
» Abnehmbare Fingerauflage. Konvexe Klinge

» Materiale: acciaio inossidabile 4cr  
» Durezza: 51-52HRC - finitura: opaca  
» Poggiadito rimovibile.



» Schnitt  
» Da taglio

5,5"

REF.07104



» Schnitt  
» Da taglio

6"

REF.07105



» Modellier  
» Per sfoltire

6"

REF.07106



## Scheren · Forbici

**CORVUS LINE-Schere**  
**Forbici CORVUS LINE**

- » Werkstoff: martensitischer Stahl 420
- » Härte: 51-52 HRC - Oberfläche: matt
- » Abnehmbare Fingerauflage.

- » Materiale: acciaio inossidabile 420
- » Durezza: 51-52HRC - finitura: opaca
- » Poggiadito rimovibile.



Mikroverzahnt  
Micro-seghettata

- » Zubehör: Öl, zwei Fingerringe aus Gummi

» Accessori: olio, due anelli in gomma per le dita

- » Schnitt
- » Da taglio

5,5"

REF.06818



- » Schnitt
- » Da taglio

6"

REF.06819



- » Modellier
- » Per sfoltire

6"

REF.06820

**SCULPTOR LINE-Schere**  
**Forbici SCULPTOR LINE**

- » Werkstoff: martensitischer Stahl 420
- » Härte: 51-52 HRC - Oberfläche: matt
- » Abnehmbare Fingerauflage.

- » Materiale: acciaio martensitico 420
- » Durezza: 51-52HRC - finitura: opaca
- » Poggiadito rimovibile.



Mikroverzahnt  
Micro-seghettata

- » Zubehör: Öl, zwei Fingerringe aus Gummi

» Accessori: olio, due anelli in gomma per le dita

- » Schnitt
- » Da taglio

5,5"

REF.06822



- » Schnitt
- » Da taglio

6"

REF.06823



- » Modellier
- » Per sfoltire

6"

REF.06824

**LOYAL Schere**  
**Forbici LOYAL**

- » Werkstoff: martensitischer Stahl 420J2
- » Härte: 52-54 HRC - Oberfläche: matt
- » Abnehmbare Fingerauflage.

- » Materiale: acciaio inossidabile 420J2
- » Durezza: 52-54HRC - finitura: opaca
- » Poggiadito rimovibile.



Mikroverzahnt  
Micro-seghettata

- » Zubehör: Öl, zwei Fingerringe aus Gummi

» Accessori: olio, due anelli in gomma per le dita

- » Schnitt
- » Da taglio

5,5"

REF.07119



- » Schnitt
- » Da taglio

6"

REF.07120



- » Modellier
- » Per sfoltire

6"

REF.07121



**NEOSTAR-Schere**  
**Forbici NEOSTAR**» Werkstoff: martensitischer Stahl 420J2  
» Härte: 56 HRC» Materiale: acciaio inossidabile 420J2  
» Durezza: 59-61 HRC1  
u.m.vta 10  
boxMikroverzahnt  
Micro-seghettata» Schnitt  
» Da taglio

5,5"

REF.06964

» Schnitt  
» Da taglio

6"

REF.06965

» Modellier  
» Per sfoltire

5,5"

REF.06966

» Schnitt  
» Da taglio

5,5"

REF.06964/70

» Schnitt  
» Da taglio

6"

REF.06965/70

» Modellier  
» Per sfoltire

5,5"

REF.06966/70

**Rostfreie Schere SATINY**  
**Forbici inox SATINY**» Einzelklinge mikroverzahnt  
» Una lama micro-seghettata» Schnitt  
» Da taglio

5,5"

REF.00725

» Schnitt  
» Da taglio

6"

REF.00726

» Schnitt  
» Da taglio

6,5"

REF.00727

1  
u.m.vta 30  
box



**STAINLESS-Schere**  
**Forbici INOX**1  
u.m.vta 30  
box» Modeller  
» Per sfoltire

5,5"

REF.00724

» ModellerEffilier  
» Per sfoltire

5,5"

REF.00728

**ELEGANT-Schere mit Messerschneide, schwarz und-goldener Griff**  
**Forbici ELEGANT affilatura a rasoio, nere con manico dorato**1  
u.m.vta 12  
box» Schnitt  
» Da taglio

5,5"

REF.04499

» Modeller  
» Per sfoltire

5,5"

REF.04500

**BLACK Schere mit Messerschneide, matt schwarz**  
**Forbici BLACK con affilatura a rasoio, nero satinato**1  
u.m.vta 12  
box» Schnitt  
» Da taglio

5,5"

REF.04501

» Modeller  
» Per sfoltire

5,5"

REF.04502



**Professionelle Schere mit legiertem Griff und seidenmatter Klinge DARK GARDEN**  
**Forbici professionali manico in lega lama satinata DARK GARDEN**

1 u.m.vta 12 box

5,5"

REF.03677

- » Modellier
- » Per sfoltire



**Professionelle Schere mit Kunststoffgriff**  
**Forbici professionali con manico in plastica**

Mikroverzahnt  
Micro-seghettata

1 u.m.vta 12 box

- » Schnitt
- » Da taglio

6"

REF. 01977

- » Modellier
- » 30 Zähne

6"

REF. 01978

- » Per sfoltire
- » 30 denti



- » Schnitt
- » Da taglio

5,5"

REF.00722

- » Schnitt
- » Da taglio

6"

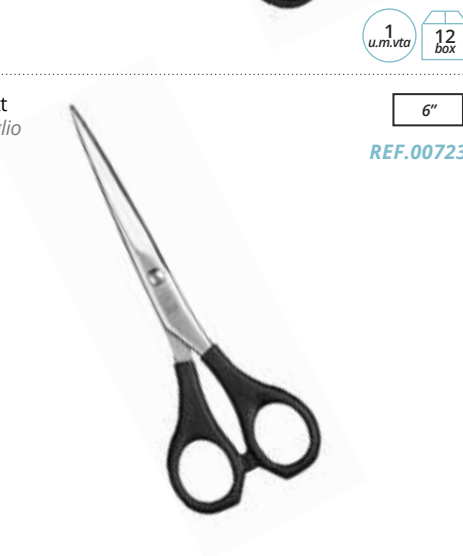
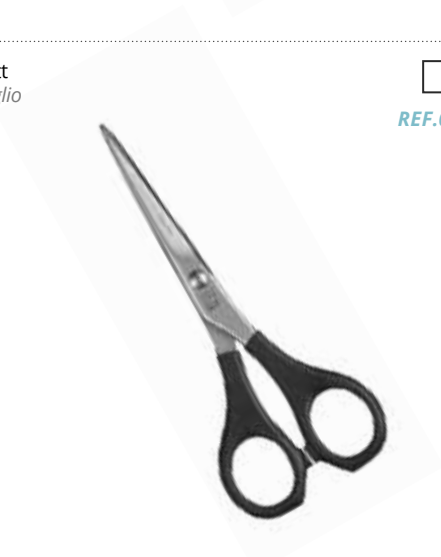

REF.00723



### Schere SPECIAL ACADEMY Kunststoffgriff

#### Forbici SPECIALI PRINCIPIANTI con manico in plastica

 Mikroverzahnt  
Micro-seghettata

 1  
u.m.vta
  12  
box

 » Schnitt  
» Da taglio

5"

REF.02807

 » Schnitt  
» Da taglio

5,5"

REF.02808

 » Modellier  
» 22 Zähne

6"

REF.02809

 » Per sfoltire  
» 22 denti

### INITIATION Schere

#### Forbici RAGNAR

 » Schnitt  
» Da taglio

6"

REF.04358

 » Schnitt  
» Da taglio

6,5"

REF.04359

 » Schnitt  
» Da taglio

7"

REF.04360

 » ModellierEffilier  
» Per sfoltire

6,5"

REF.04361



**Etui 2 Scheren Schneide/Modellierschere**  
**Astucci da 2 forbici da taglio/sfoltire**



6"

REF.06821



6"

REF.06825

**Etui FLASH 2 Scheren Schneide/Modellierschere**  
**Astucci FLASH da 2 forbici da taglio/sfoltire**



5,5"

REF.07107



### Kunstleder Etui Custodia in ecopelle

1 u.m.vta 12 box

Kunstleder Etui mit:

- » Messerklingen-Schere
- » Modellierschere
- » Rasiermesser wechselbar 00698
- » Professioneller Kamm 00115

Astuccio in simipelle con:

- » Forbici da taglio affilatura rasoio
- » Forbici per sfoltire
- » Rasoio lama intercambiabile 00698
- » Pettini professionale 00115



5,5"

REF.03267

### Friseur-Kit für Anfänger Kit taglio studente

Etui mit:

- » 1 Schere zum Schneiden
- » 1 Modellierschere
- » 1 Rasiermesser Metall
- » Rasierklinge

Astuccio con:

- » 1 forbice da taglio
- » 1 forbice per sfoltire
- » 1 rasoio in metallo
- » Lama rasoio



6"

REF.04901

### Etui 2 Scheren Schneide/Modellierschere Astucci da 2 forbici da taglio/sfoltire

1 u.m.vta 12 box

- » Glänzende Schere
- » Forbici lucide



Mikroverzahnt  
Micro-seghettata

5,5"

REF.03682



**Scherenkoffer für 20 Stück (leer)**  
 Valigetta porta-forbici per 20 unità (vuota)

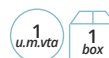

REF.04634



**Behälter für Scheren**  
 Contenitore per forbici



REF.04740



**Scheren-Aussteller**  
 Espositore per forbici



REF.04074

» Plexiglas  
 » Plexiglass



**Haarschnitt**  
 Rasoio

» Eine Klinge  
 » Una lama

REF.00961



» Zwei Klingen  
 » Due lame



REF.00962



**Schachtel 100 Einweg Rasierklingen Pollié**  
 Caonfezione di 100 rasoi monouso Pollié'

» Mit Schutz  
 » Con protezione



REF.02480



## 10 Schachtel mit je 10 Profi-Messern Eurostil Styling Scatola di 10 confezioni, di 10 lame styling



Das Messerblatt ist aus hochwertigem, platinhaltigem Inox-Stahl und daher langlebig. Die Fläche ist mit Teflon behandelt, was eine sanfte und komfortable Rasur ermöglicht. Die Plastikbox schützt das Messer.

La lama è realizzata in acciaio inossidabile di alta qualità con una placcatura in platino, che rende più liscia la rasatura e dà una sensazione di rasatura più confortevole.



Ersatzklingen: 01498 -04073-04075  
Ricambio per rasoi: 01498 -04073- 04075



NEW

REF.07123

Preis von 10 Kartons mit 10  
Blatt: 26 €  
Spender von 10 Blatt 2,6 €

» Mit Teflon behandelt  
» Con rivestimento in teflon

Prezzo 10 scatole da 10 fogli:  
26€  
Dispenser da 10 fogli 2,6€

## Rasiermesser Rasoi

» Rasiermesser Silber aus Metall  
» Rasoio argento metallizzato



REF.02535/54



» Metallicblau  
» Mit Schutz



REF.04073

» Kunststoffgriff  
» Mit Schutz

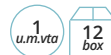

REF.04075

» Silbermetallic  
» Argento metallizzato



REF.01498

» Blu metallizzato  
» Con protezione

» Manico in plastica  
» Con protezione

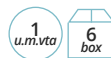

**FEATHER-Klingen**  
Rasoi FEATHER

REF.04386

REF.04387

**Schachtel mit 10 Klingen STYLING RAZORS · Confezione da 10 lamette STYLING RAZORS**

REF.07159



REF.04388



REF.04389

Ersatzklingen: 04386 - 04387  
Ricambio per rasoi: 04386 - 04387**FEATHER NAPE RAZOR Messer**  
Rasoi FEATHER NAPE RAZOR

REF.04394

**Spender mit 20 Klingen**  
Dispenser 20 lamette**Professional PB-20**

REF.04391

**Schachtel mit 10 Klingen NAPE RAZOR**  
Confezione da 10 lamette  
NAPE RAZOR

REF.04395





# Klebe-extensions und haarteile

EXTENSION  
ADESIVE

*Haarteile , Extensions , Klammern,  
Ringe, Kleber, Lösungsmittel...*

*Extension, clips, colla*



## Remy Echthaar Extensions

### Extension di capelli naturali remy

1 u.m.vta  
10 box

10 cm



50 cm

» Haargewicht ca. 98-100 Gramm

» Peso extension 98-100 grammi circa.



» Schwarz  
» Neri

N°1

REF.03354



» Rötlich  
» Rossastro

N°30M

REF. 03363



» Kastanienbraun  
» Castano ramato

N°10

REF.03357



## Remy Echthaar Extensions mit Clip

### Extension a retina di capelli naturali remy con clip

1 u.m.vta  
6 box

15 cm



50 cm

» 15 cm breiter Haarteil mit 3 Clips und 50 cm lang  
» Remy Haar  
» Jede Klammer ist 2,8 mm breit  
» Gewicht: etwa 20 g (mit Klammern)

» Extension larga 15 cm con 3 clip e lunga 50 cm  
» Capelli remy  
» Ogni clip è lunga 2,8 mm  
» Peso: 20 gr circa (con clip)



» Rötlich  
» Rossastro

N°30M

REF.03650

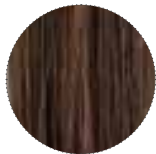

» Castaño Rötlich  
» Castano rossastro

N°30

REF.03651



» Kastanienbraun  
» Castano ramato

N°10

REF.03644



## Keratin-Extensions

### Extension cheratina

1 u.m.vta  
6 box



50 cm

» Pack 20 Extensions 50 cm lang  
» Remy Haar  
» Keratin  
» Gewicht: ca. 14 gr.

» Confezione da 20 extension di 50 cm di lunghezza  
» Capelli remy  
» Cheratina  
» Peso: 14 gr. circa

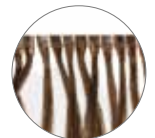

» Kastanienbraun  
» Castano ramato

N°10

REF.03369



» Dunkles Kupferbraun  
» Castano scuro ramato

N°32

REF.03377

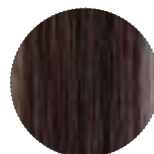

**Dose mit gravierten Alu-Ringen**  
**Confezione ring ricambi per ciocche in alluminio**

100 Stück für Extensions  
 100 unità per extension



» Schwarz  
 » Neri

N°1

REF.02911



» Dunkelbraun  
 » Castano scuro

N°3

REF.02912



» Mittelbraun  
 » Castano medio

N°5

REF.02913



» Dunkelblond  
 » Biondo scuro

N°1

REF.02914



» Platin-Blondine  
 » Biondo platino

N°3

REF.02915



» Bordeaux  
 » Bordeaux

N°5

REF.02927



**Dose mit gravierten Alu-Ringen**  
**Barattolo ring ricambi per ciocche in alluminio**

1000 Stück für Extensions  
 1000 unità per extension



» 68 gr  
 » 68 gr

» Schwarz  
 » Neri

N°1

REF.02867



» Dunkelbraun  
 » Castano scuro

N°3

REF.02868



» Mittelbraun  
 » Castano medio

N°5

REF.02869



» Dunkelblond  
 » Biondo scuro

N°1

REF.02870



» Platin-Blondine  
 » Biondo platino

N°3

REF.02871



» Bordeaux  
 » Bordeaux

N°5

REF.02921



### Packung mit Clips für große Extensions 3,2 cm

#### Sacchetto di clips per extension grandi 3,2 cm

» Schwarz  
» Nero



50 u

REF.02924/50



4 u

REF.03269/50

» Braun  
» Marrone



50 u

REF.02924



4 u

REF.03269



3,2 cm



3,2 cm

» Silber  
» Argento



50 u

REF.02924/54



4 u

REF.03269/54

» Blond  
» Biondo



50 u

REF.02924/66



4 u

REF.03269/66



3,2 cm



3,2 cm

### Packung mit Clips für 2,8-cm Extensions-

#### Sacchetto di clips per extension 2,8 cm

» Schwarz  
» Nero



50 u

REF.03306/50



4 u

REF.03270/50

» Braun  
» Marrone



50 u

REF.03306



4 u

REF.03270



2,8 cm



2,8 cm

» Silber  
» Argento



50 u

REF.03306/54



4 u

REF.03270/54

» Blond  
» Biondo



50 u

REF.03306/66



4 u

REF.03270/66



2,8 cm

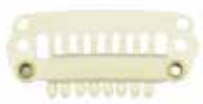

2,8 cm

## Packung mit Clips für 2,2-cm Extensions Sacchetto di clips per extension 2,2 cm

» Schwarz  
» Nero

1 u.m.vta 20 box

50 u

REF.03307/50



— 2,2 cm —

12 u.m.vta 12 box

4 u

REF.03271/50

» Braun  
» Marrone

1 u.m.vta 20 box

50 u

REF.03307



— 2,2 cm —

12 u.m.vta 12 box

4 u

REF.03271

» Silber  
» Argento

1 u.m.vta 20 box

50 u

REF.03307/54



— 2,2 cm —

12 u.m.vta 12 box

4 u

REF.03271/54

» Blond  
» Biondo

1 u.m.vta 20 box

50 u

REF.03307/66



— 2,2 cm —

12 u.m.vta 12 box

4 u

REF.03271/66

## Klebstoff zum Fixieren von Haarteilen Colla per fissare le extension sui capelli

» Auf Basis von Naturlatex  
» Farbe des Klebstoffs: Dunkel

50 ml

REF.03176/50

» A base di lattice naturale  
» Colore adesivo scuro



» Auf Naturlatex basierend  
» Farbe des Klebstoffs: Weiß

50 ml

REF.03176/58

» A base di lattice naturale  
» Colore adesivo bianco



## Auf Naturlatex basierend Farbe des Klebstoffs: Weiß Solvente per extension alla cheratina

1 u.m.vta 20 box

150 ml

REF.03164



## Haarteile mit Lösungsmittelkleber Solvente adesivo per extension

1 u.m.vta 20 box

150 ml

REF.03177



**Packung 12-Scheiben für extensions**  
**Sacchetto da 12 dischi per extension**

1 u.m.vta  
60 box

12 u

REF.02582



**Packung mit Ringnadeln**  
**Confezione di uncini per anelli**

1 u.m.vta  
5 box

12 u

REF.02873



**Zange für extensions**  
**Pinze per extension**

- » Zweifarbiger Griff
- » Manico bicolore

1 u.m.vta  
60 box

REF.02872



**Spezial-Zange extensions**  
**Pinze speciali per extension**

- » Mit Ring
- » A molla

1 u.m.vta  
60 box

REF.02581



**Farbmuster für extensions**  
**Campionario extension colorate**

1 u.m.vta  
20 box

REF.03378



**Auswahl extensions**  
**Kit per extension**

1 u.m.vta  
12 box

REF.04208



12

# Verschiedenes

VARI

*Handtücher, Koffer,  
Sprays, Watte...*

*Asciugamani, spruzzini, valigie  
e trolley da la lavoro*



**1 kg Watte in Rollen**  
**1 Kg di cotone in rotoli**



- » 9 Schnitte von 3,5 cm (einschließlich Spitzen)
- » 9 tagli da 3,5 cm (punte incluse)

REF. 00964 REF. 00964/00



Anonym  
 Senza marca



- » Breite
- » 4 Schnitte von 8 cm (einschließlich Spitzen)

REF. 04290

- » Largo
- » 4 tagli da 8 cm (punte incluse)



- » Gefaltet
- » 9 Schnitte von 3,5 cm (einschließlich Spitzen)

REF. 04288

- » Piegato
- » 9 tagli da 3,5 cm (punte incluse)





**Schwarze Friseurertasche**  
*Borsa da parrucchiere nera*

1 u.m.vta  
6 box  
REF. 02517



1 u.m.vta  
10 box  
REF. 02596

**Werkzeugtasche schwarz**  
*Borsa porta utensili*

1 u.m.vta  
5 box

REF. 02516

**Tasche - Rucksack für die Akademie**  
*Borsa - zaino scuola*

1 u.m.vta  
15 box

Bequemer schwarzer Textilkoffer mit Aufhänger und Riemen zum Tragen als Rucksack. Sie hat einen Griff zum Tragen als Handgepäckstück und auch einen Schultergurt. Enthält 2 Fächer und einen Kartenhalter.

*Comoda borsa in stoffa nera. Ha una presa per portarla come bagaglio a mano e anche una tracolla per portarla a spalla. Include 2 scomparti e un portata-carte.*

REF. 07018



**Aluminium-Koffer**  
**Valigie in alluminio**Alle Koffer werden leer verkauft  
*Tutte le valigie sono vuote*

- » Für Utensilien, klarer Innenraum und 4 Ablagen
- » *Per strumenti, interno spazioso composto da 4 scomparti*



REF.03598

- » Für Utensilien, innen 6 Fächer und 4 Ablagen
- » *Per strumenti, interno composto da 6 scomparti 4 vassoi*

REF.03599



REF.02318

REF. 02319



REF.04307



**Aluminium-Koffer**  
Valigie in alluminioAlle Koffer werden leer verkauft  
Tutte le valigie sono vuote

REF.02317

» Für Utensilien  
» Porta strumenti

REF.01497



REF.01492



REF.04306

**Schwarzer PVC-Koffer**  
*Valigia in PVC nera*Alle Koffer werden leer verkauft  
*Tutte le valigie sono vuote*

REF.02925

**Melamingrauer Profi-Koffer (leer)**  
*Valigia professionale grigia (vuota)*

REF.02593

**Trolley-Koffer**  
*Valigia trolley*

REF.02523/50



REF.02929/50



REF.02929



**Trolley-Koffer aus Kunstleder für Friseure**  
**Valigia trolley in similpelle per parrucchiere**

Alle Koffer werden leer verkauft  
 Tutte le valigie sono vuote

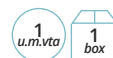

REF.04308



**Trolley-Koffer "COCODRILO" aus Kunstleder für Friseure**  
**Valigia trolley "COCCODRILLO" in similpelle per parrucchiere**

Alle Koffer werden leer verkauft  
 Tutte le valigie sono vuote



REF.06136

- » Es besteht aus: 3 großen Fächern mit je 2 Fächern oben. Das Tablett hat einige Fächer, in denen Utensilien untergebracht werden können.
- » Mit montierbaren Rädern lässt er sich bei Bedarf bequemer und einfacher bewegen.

» Composta da: 3 ampi scomparti con 2 vassoi ciascuno nella parte superiore. Il vassoio ha scomparti per riporre gli strumenti.

» Con ruote rimovibili, per essere spostata più comodamente e facilmente, a seconda delle necessità.



### Friseur-Tasche mit Rädern Trolley da lavoro, parrucchiere

- » Mit einer Metallstruktur, die es ermöglicht, den Koffer als Sitz zu verwenden
- » Con struttura in metallo che permette di utilizzare la valigia come seduta

Alle Taschen werden leer verkauft  
Tutte le valigie sono vuote



**Inklusive Toilettentasche (leer)**  
Beauty case (vuoto) incluso



REF.04402/50



REF.04402/80

### Trolley-Koffer Valigia trolley

TALLE Taschen werden leer verkauft  
Tutte le valigie sono vuote



REF.03814/68



REF.03814/50

### 4-teiliger Koffer Valigia a 4 blocchi

Alle Taschen werden leer verkauft  
Tutte le valigie sono vuote



- » 3-teiliger Koffer. Die ersten 2 an der unteren Basis haben 4 Beine und die vierte hat 5 Räder
- » Innenseite mit schwarzer Schaumstoffbeschichtung
- » Höhenverstellbarer Griff je nach Körperanforderungen
- » 1. und 2. Kofferteil: ca. 24,5 x 21,5 x 9 cm hoch, inkl. 2 Seitenteiler mit Leitschienen, um den Raum je nach Bedarf anzupassen.
- » 3. Kofferteil: ca. 24,5 x 21,5 x 35 cm hoch, völlig lichtdurchlässig.
- » 4. Kofferteil: ca. 24,5 x 21,5 x 18 cm hoch, völlig lichtdurchlässig.

- » Valigia a 4 blocchi. I primi 2 alla base inferiore hanno 4 gambe e il quarto ha 5 ruote
- » Interno foderato in gommapiuma nera
- » Manico regolabile in altezza in base alle esigenze del corpo
- » 1° e 2° blocco: Misure approssimative 24,5 x 21,5 x 9cm di altezza, comprende 2 divisori laterali con guide per adattare lo spazio a seconda delle esigenze.
- » 3° blocco: Misure approssimative 24,5 x 21,5 x 35cm di altezza, completamente aperto
- » 4° blocco: Misure approssimative 24,5 x 21,5 x 18cm di altezza, completamente aperto



### Koffertasche zweistöckig aus Nylon mit Rädern Valigia doppia in nylon con ruote



Die obere Koffertasche kann in ein Handgepäck umgewandelt werden, das mit einem Schulterriemen versehen ist. Er hat zwei seitlich verschiebbare Innenfächer, der Innenraum ist breit und der untere Teil ist abnehmbar und kunststoffbeschichtet, um die Reinigung des Koffers zu erleichtern. Es hat auch eine Außentasche auf der Rückseite. Das Untergehäuse mit Rädern hat eine kunststoffbeschichtete Innenseite, ist zur leichten Reinigung abnehmbar und wird mit einer Bürstenhalterdecke geliefert, die mit einem Klettverschluss befestigt wird. Diese Decke ist austauschbar zwischen die Oben- und Unter-Gehäuse. Es verfügt über 8 Schubladen zur Lagerung und Trennung kleiner Produkte. Es hat auf jeder Seite eine Tasche. Jedes Abteil hat 4 Schubladen integriert, die in einem Stück verbunden sind, sie sind herausnehmbar.

REF.04943

La valigia può essere convertita in un bagaglio a mano che viene fornito con una tracolla. Ha due vassoi interni che possono essere spostati ai lati, l'interno è spazioso e la parte inferiore è estraibile e laminata in plastica per facilitare la pulizia della valigia. Anche nella parte posteriore ha una tasca esterna. La valigia inferiore con ruote ha la parte interna plastificata, è estraibile per facilitare la pulizia e viene fornita con un porta spazzole che si fissa tramite velcro. Questo porta spazzole può essere scambiato tra la valigia superiore e quella inferiore. Dispone di 8 cassetti per riporre e separare piccoli prodotti. Ha una tasca su ogni lato. Ogni colonna integra 4 cassetti uniti in un unico blocco e che sono rimovibili.



**Trolley-Koffer mit 2 Kästen**  
**Valigia trolley a 2 blocchi**Alle Koffer werden leer verkauft  
*Tutte le valigie sono vuote*

Der Trolley-Koffer von Pollié wurde auf der Grundlage einer Struktur mit zwei modifizierbaren Stockwerken geschaffen, die es den Fachleuten erleichtern soll, ihre Friseur-, Make-up- oder Kosmetikutensilien unterzubringen. Der obere Teil des Gehäuses besteht aus drei herausnehmbaren Schubladen. Jede von ihnen ist in drei Fächer unterteilt.

In einem von ihnen finden Sie zwölf kreisförmige Räume, in denen der Nagellack aufbewahrt werden kann, so dass er sich nicht auslaufen kann, was seinen Transport in völliger Sicherheit erlaubt. Ebenso kann das Innere des Oberteils nach Ihren Bedürfnissen modifiziert werden, indem die Struktur der Fächer variiert wird. Seine 2 in 1-Funktion schließlich ermöglicht es Ihnen, ein Handgepäck zu haben, oder Sie ziehen es vor, es an die Schulter zu hängen, dank seines Nylonriemens. Im unteren Teil des Koffers befindet sich eine herausnehmbare Tablett mit einer Option von 4 Fächern, die dank der Trennwände auch modifiziert werden können. Der untere Korpus mit großem Fassungsvermögen im Inneren bietet Ihnen die Möglichkeit eines leichteren Transports, da er in einen kleineren Koffer umgewandelt werden kann, in den ein Deckel und ein Spiegel integriert sind. Die Räder sind mit Hilfe der Hakenlasche tauschbar. Der Wagen hat zwei Rollen und zwei Ersatzschlüssel.

*Il trolley Pollié è concepito sulla base di una struttura a 2 blocchi modificabili ed è studiato per facilitare ai professionisti la disposizione dei propri strumenti da parrucchiere, trucco o cosmetici.*

*La parte superiore del trolley è composta da tre vassoi rimovibili. Ognuno di essi è diviso in tre scomparti.*

*A sua volta, in ognuno di essi, troverai dodici scomparti circolari pensati per riporre gli smalti per unghie affinché rimangano fermi facilitando così il loro trasporto in totale sicurezza. Inoltre, l'interno del blocco superiore può essere modificato in base alle proprie esigenze, variando la struttura degli scomparti. Infine, la sua funzione 2 in 1 ti permetterà di avere un bagaglio a mano o se preferisci puoi portarlo a tracolla grazie alla sua cintura in nylon.*

*La parte inferiore della valigia ha un vassoio estraibile con possibilità di creare 4 scomparti anch'essi modificabili grazie ai divisori. La parte inferiore del blocco, con una grande capacità interna, ti darà la possibilità di effettuare un trasporto più leggero, poiché può essere trasformata in una valigia più piccola con anta e specchio incorporato. Le ruote sono intercambiabili tramite la linguetta di aggancio. Il trolley ha due serrature e due chiavi di scorta*

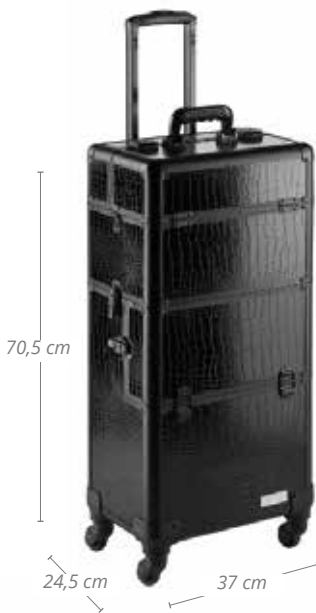

REF.04939/50



REF.04939





### Friseurtasche schwarz Porta strumenti nero

Alle Friseurtaschen werden leer verkauft  
Tutti i porta strumenti sono venduti vuoti



REF. 01238



REF. 01236



REF. 01237



REF. 02515



REF. 02513



REF. 02514



### Friseur Taschen Friseur gürtel Cintura porta strumenti

- » Mit 5 kombinierten Taschen
- » Con 5 tasche combinabili

Alle Friseur Taschen werden leer verkauft  
Tutti i portautensili vengono venduti vuoti

1 u.m.vta  
48 box

REF.03622



1 u.m.vta  
48 box

REF.04310

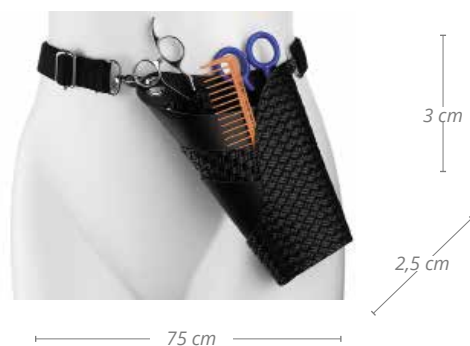

**Box mit 50 Stück Gesichtsschutz FACEPRO**  
Confezione da 50 unità protezione viso FACEPRO**Exklusiv-Verkaufsartikel in SPANIEN, PORTUGAL UND ANDORRA**  
Articoli in vendita esclusiva IN SPAGNA, PORTOGALLO E ANDORRA

REF. 04480

**Organisches Material**  
Bio

REF. 04223

**KEIN Organisches Material**  
NO Bio

**Face pro schützt das Gesicht vor abgeschnittenen Haaren, Haarspray,  
heißer Luft aus dem Fön, Farbstoffen...**  
**Face pro protegge il viso dai capelli tagliati, dalla lacca, dall'aria calda dell'asciugacapelli,  
dalle tinture...**

**Sortierkasten (leer)**  
Organizer (vuoto)

REF.04722

» Magnetisch  
» Magnetizzato

REF.04309

**Visitenkartenbox aus Aluminium**  
Porta biglietti da visita in alluminio

REF.02470

**Taschen-Aufhänger/ Haken**  
Gancio appendiabiti

REF.03304



**Utensilentasche aus Silikon**  
Portautensili in silicone1  
u.m.vta 48  
box» Mit Saugnäpfen  
» Con ventose1  
u.m.vta 6  
box

REF.04370

REF.04404/68



REF.04404/50

**Gesichtsschutz**  
Visiera20  
u.m.vta 20  
box**Spiegel**  
Specchi1  
u.m.vta 12  
box

REF.00287

REF.01233

**Spiegel**  
Specchi1  
u.m.vta 12  
box

REF.00286

1  
u.m.vta 6  
box

REF.02538/54

1  
u.m.vta 1  
box

REF.03626



**Perückenträge****Testina porta parrucca**

Ø 59



REF. 03489



REF. 04367



Ø 16 - 17

» Styropor  
» Polistirolo**Perückenträge**  
**Porta parrucca**

REF. 00982

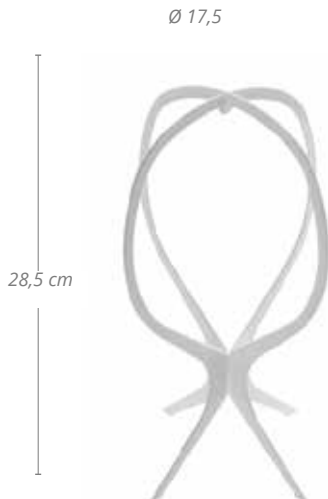
» Unterwegs  
» Trasportabile

Ø 17,5

28,5 cm

REF. 00982/50

**Sprüflasche STIL**  
**Spruzzino STIL**

260 ml

» Transparent  
» Transparente

REF. 02683



**Farbige Sprühflasche transparent**  
Spruzzino trasparente colorato

330 ml  
● ● ●  
REF.00959

300 ml  
● ● ●  
REF.01372

» Rund  
» Rotondo

300 ml  
● ● ●  
REF.01484

300 ml  
● ● ●  
REF.01663

**Sprühflasche 360°**  
Atomizzatore spray 360°

300 ml  
REF.04731

**Desinfektionssprüher 360°**  
Spray disinfettante continuo

NEW

300 ml  
REF.07247

- » Kontinuierliches Sprühen: Mit einem einzigen Druck wird das Wasser vom Anfang bis zum letzten Tropfen gleichmäßig und fein mit dem gleichen Druck gesprüht.
- » 360°: Kann aus allen Winkeln verwendet werden, auch verkehrt herum. Feines, nebelartiges Spray, das das Wasser gleichmäßig über alle Haare verteilt
- » Fassungsvermögen: 300 ml nachfüllbar.
- » Festes Druckvolumen: 1,25 ccm kontinuierlich.
- » Vermeiden Sie Ermüdung der Hände im Vergleich zu Standardsprays. Ohne umweltschädliche Gase.

- » *Spruzzo continuo: con una sola pressione spruzza l'acqua in modo uniforme e fine con la stessa pressione dall'inizio fino all'ultima goccia.*
- » *360°: può essere utilizzato da tutte le angolazioni, anche sottosopra.*
- » *Nebulizzazione sottile: tipo di nebulizzazione che distribuisce l'acqua in modo uniforme su tutti i capelli.*
- » *Capacità: 300 ml ricaricabili. Volume di pressione fisso: 1,25 cc continuo.*
- » *Evita l'affaticamento della mano rispetto agli spruzzatori standard Senza gas inquinanti.*



**Sprühflasche Aluminium**  
**Spruzzino in alluminio**» Innen lackiert  
» Interno laccato

23,5 cm



280 ml

REF.01384

» Neutral  
» Neutro

280 ml

REF.01384/02

**Stellkasten mit 30 Aluminium- Sprühflaschen**  
**Espositore 30 spruzzini in alluminio**

280 ml

REF.01465

» Eurostil  
» Eurostil

280 ml

REF.01465/02

» Neutral  
» Neutro**Zerstäuber aus Kunststoff**  
**Spruzzino in plastica**» Mit Anhänger  
» Con gancio

130 ml

REF.03401

» Japanisch schwarz  
» Nero giapponese

300 ml

REF.04377



**Handtuch aus 100% Baumwolle**  
**Asciugamano 100% cotone**



380 gr

REF. 02947/50

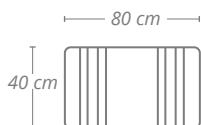

REF. 02947/58

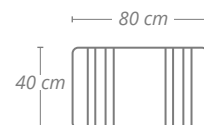

REF. 02901/50

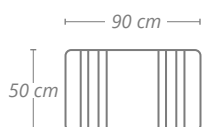

REF. 02901/58

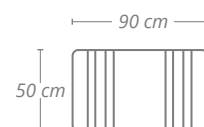

- » Bleichmittelbeständig
- » Resistente alla candeggina

REF. 04953/50

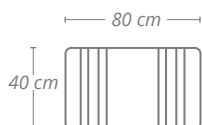

NEW

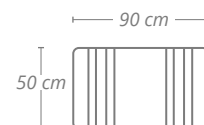

REF. 06829/50



## Hydroalkoholisches Gel mit Aloe Vera

### Gel idroalcolico con Aloe Vera



NEW

1 u.m.vta  
40 box  
100 ml  
REF.07245



NEW

1 u.m.vta  
20 box  
500 ml  
REF.07235



NEW

1 u.m.vta  
12 box  
1 L  
REF.07267



NEW

1 u.m.vta  
2 box  
5 L  
REF.07268



## Hydroalkoholische Lösung

### Soluzione idroalcolica

NEW

1 u.m.vta  
63 box  
100 ml  
REF.07174



NEW

1 u.m.vta  
23 box  
500 ml  
REF.07175



NEW

1 u.m.vta  
7 box  
1 L  
REF.07259



NEW

» Mit dosierpumpe  
» Con pompa dosatrice

1 u.m.vta  
7 box  
1 L  
REF.07213



### Hydroalkoholisches Gel Gel idroalcolico



REF.07215

NEW



### Alkohol 96° Alcol 96°



REF.07217

NEW



### Dosierpumpe gel 1l / 500 ml Pompa dosatrice gel 1l / 500 ml

Ideal zum Mischen mit Wasser und zum Befüllen des Zerstäubers für die Reinigung und Desinfektion von Oberflächen

Ideale per miscelare con acqua e spruzzare per pulire e disinfettare le superfici



REF.RE07267



### Handdesinfektionsmittel in sprayform Igienizzante per le mani in spray

Zur Desinfektion der Hände ohne Notwendigkeit von Wasser und Seife. Hält die Hände jederzeit sauber und schützt sie vor äußeren Einflüssen. Hoher Gehalt an Glycerin, das der Haut Feuchtigkeit spendet. AUSSCHLIESSLICH AUF GESUNDER HAUT VERWENDEN.

Per igienizzare le mani senza bisogno di acqua e sapone. Formulato per mantenere le mani pulite in ogni momento, proteggendole da agenti esterni. Alto contenuto di glicerina che funge da idratante per la pelle. USO ESCLUSIVO SU PELLE SANA.

NEW

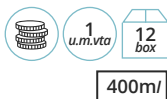

REF.07231

### Verkaufsträger 120 sachets mit desinfektionstuch Espositore 120 bustine con salvietta igienizzante

Reinigung ohne Wasser. Für eine gesunde und saubere Haut überall

Pulizia senza acqua. Per una pelle sana e pulita ovunque



REF.07236

NEW



**Artikel, die ausschließlich in Spanien verkauft werden**  
**Articoli in vendita esclusiva IN SPAGNA**

**Antiseptikum Daromix GH**  
**Antisettico Daromix GH**

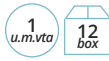

500 ml

REF.06200



- » AEMPS-Registrierungsnummer: 905-DE5
- » Wasser-alkoholisches Antiseptikum zur hygienischen Händedesinfektion durch Reibung
- » Wissenschaftlich garantierte Wirksamkeit
- » Breites Biozidspektrum ab 30 sec
- » Hypoallergene Formel
- » Bewahrt die Hautfeuchtigkeit
- » Keine Hautreizung
- » Trocknet schnell
- » Wirksam als: Bakterizid, Levurizid, Viruzid, Mikrobakterizid

- » Numero di registrazione AEMPS: 905-DE5
- » Antisettico idroalcolico per la disinfezione igienica delle mani per sfregamento
- » Efficacia scientificamente garantita
- » Biocida ad ampio spettro a partire da 30 sec
- » Formula ipoallergenica
- » Preserva l'idratazione della pelle
- » Non irritante per la pelle
- » Asciuga velocemente
- » Efficace come: battericida, lieviticida, viricida, microbattericida

**Desinfektionsmittel Limoseptol**  
**Disinfettante Limoseptol**



50 ml

REF. 06151



1 L

REF.06150



- » Dosis: 100 ml in 10 l Wasser
- » Zeit: 15 min
- » AEMPS-Registrierungsnummer: 47-DE5
- » Hochwertiges Produkt, das ausschließlich für die Hygiene, Reinigung und Desinfektion von professionellem Salonzubehör entwickelt wurde
- » Waschmittelwirkung - Breites Spektrum
- » Biologisch abbaubar - phosphatfrei und FORMOLFREI
- » Keimtötende und desinfizierende Wirkung gegen: Bakterien, Hefen und Pilze

- » Dose: 100 ml in 10 l d'acqua
- » Tempo: 15 minuti
- » Numero di registrazione AEMPS: 47-DE5
- » Prodotto di alto livello sviluppato esclusivamente per l'igiene, la pulizia e la disinfezione degli utensili professionali nei centri estetici
- » Azione detergente - Ampio spettro
- » Biodegradabile - Senza fosfati e senza FORMOLO
- » Efficacia germicida e DISINFETTANTE contro: batteri, lieviti e funghi

### Desinfizierende fussmatte Tappetino disinfectante per scarpe

1  
u.m.vta

12  
box

REF.07234

Extra flache Fußmatte mit nur 1 cm Höhe zur Verhinderung von Ausrutschen, hergestellt aus Polypropylen auf einer Gummiunterlage, enthält ionisiertes Aluminium. Maße: 60 cm Breite x 40 cm Länge x 1 cm Höhe/Dicke.

Verwendung: die Matte auf eine ebene, waagerechte Fläche legen, etwa 700 ml Desinfektionsflüssigkeit auf die Ablage auftragen. Es ist ratsam, einen Fußabtreter auf die Ablage zu legen, um die Schuhe des Kunden zu trocknen.

*Tappetino extra piatto alto solo 1 cm per evitare inciampi, realizzato in polipropilene su base in gomma e contenitore in alluminio ionizzato. Misure: 60 cm di larghezza x 40 cm di lunghezza x 1 cm di altezza/spessore.*

*Modo d'uso: posizionare il tappetino su una superficie piana e livellata, applicare circa 700ml di liquido disinfectante sul vassoio. Si consiglia di posizionare un tappetino accanto al vassoio per asciugare le scarpe del cliente.*

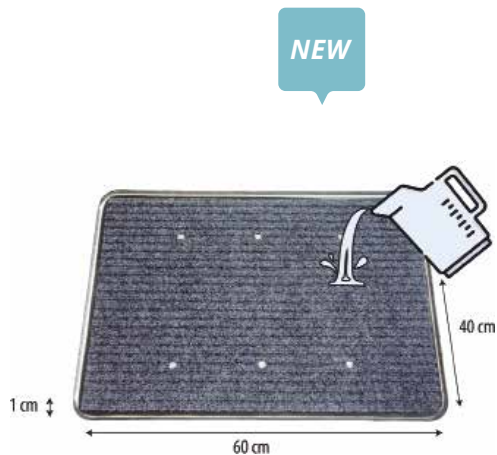

### Anti-fog Schutzbrille Occhiali protettivi antivapore

1  
u.m.vta

50  
box

REF.07256

- » Schutz zur Prävention gegen Infektionen: schützt wirksam gegen Spritzer,
- » Kies usw.
- » Verwendungsort: jeder Ort, an dem Augenschutz erforderlich ist.
- » Innovatives, komfortables Design. Passt sich perfekt an jede Kopfform und Kopfgröße an.
- » Kann gleichzeitig mit Ihrer normalen Brille verwendet werden.
- » EG-Zertifizierung
- » Material: Kunststoff

- » *Protezione per prevenire le infezioni: proteggere efficacemente da schizzi, schegge, ecc.*
- » *Luogo di utilizzo: qualsiasi luogo in cui è richiesta la protezione degli occhi.*
- » *Confortevole design innovativo. Si adattano perfettamente a qualsiasi forma e dimensione della testa.*
- » *Possano essere utilizzati contemporaneamente agli occhiali da vista.*
- » *Certificato CE.*
- » *Materiale: plastica*



### Beutel 100 schuhüberzüge Copri-scarpe 100 unita

1  
u.m.vta

50  
box

REF.07211

- » Einweg
- » Plastik
- » Monouso
- » Plastico



### Automatischer wandgelspender mit tablet

Erogatore automatico di gel da parete con vassoio



### Automatischer tisch-gel-spender

Erogatore automatico di gel da parete



### Automatischer gelspender mit sockel

Erogatore di gel automatico con treppiede



### Manueller wandspender

Erogatore manuale da parete



- » Werkstoff: ABS
- » Pumpentyp: Gel-Tropf
- » Stromversorgung: 4 Batterien (LR14 Größe C)
- » Erkennungsabstand: 6-10 cm.
- » Abgabemenge e: 0,8-1 ml einstellbar

- » Materiale: ABS
- » Tipo di pompa: erogazione di gocce di gel
- » Alimentazione elettrica: 4 batterie (LR14 tipo C)
- » Distanza di rilevamento: 6-10 cm.
- » Uscita: 0,8-1 ml regolabile

## Besen aus Gummi

### Scope di gomma

- » Mit Borsten
- » Con linguetta



4  
u.m.vta

16  
box

REF.01223



5  
u.m.vta

20  
box

REF. 01285/50

- » Die leicht zu reinigenden und langlebigen Borsten sind so konstruiert, dass sie den Staub mitreißen, ohne ihn anzuheben, was sie für Allergiker ideal macht, da sie eine saubere Umgebung begünstigen.

- » Facile da pulire e di lunga durata, l'efficienza del design dei suoi denti riesce a trascinare la polvere senza sollevarla, rendendola ideale per chi soffre di allergie.

5  
u.m.vta

20  
box

REF.02420



## Besenstiel

### Manico di scopa

- » Leicht zu reinigen und langlebig
- » Kunststoffhalter
- » Ideal für alle Arten von Böden

- » Facile da pulire e di lunga durata
- » Gancio in plastica

12  
u.m.vta

12  
box

REF.01131

- » Extra Teleskop - Speziell für Parkett
- » Telescopico extra

10  
u.m.vta

10  
box

REF.01365







# Barbershop Spezial

SPECIALE FORNITURE  
DA BARBIERE





## 01 Elektrogeräte Barber e accessori 370

RAGNAR Schneidemaschinen · <i>Tagliacapelli RAGNAR</i> .....	371
BARBER LINE Schneidemaschinen .....	374
<i>Tagliacapelli BARBER LINE</i>	
CAPTAIN COOK Schneidemaschinen .....	375
<i>Tagliacapelli CAPTAIN COOK</i>	
EUROSTIL Schneidemaschinen .....	376
<i>Tagliacapelli EUROSTIL</i>	
RAGNAR Retuschiermaschine .....	378
<i>Tagliacapelli da rifinitura RAGNAR</i>	
CAPTAIN COOK Retuschiermaschine .....	379
<i>Tagliacapelli da rifinitura CAPTAIN COOK</i>	
RAGNAR 360° Retuschiermaschine .....	382
<i>360° Tagliacapelli da rifinitura RAGNAR</i>	
CAPTAIN COOK 360° Retuschiermaschine .....	383
<i>360° Tagliacapelli da rifinitura CAPTAIN COOK</i>	
RAGNAR Rasierer, BARBER LINE Rasierer .....	384
CAPTAIN COOK Rasierer	
<i>Rasoio RAGNAR, Rasoio BARBER LINE, Rasoio CAPTAIN COOK</i>	
Nasentrimmer · <i>Tagliapeli</i> .....	387
Zubehör für Schneidemaschinen (CLIPP-AID und Öle) .....	388
<i>Accessori per macchine da taglio (CLIPP-AID e oli)</i>	
Föhn, Glätteisen- und Wachs Fixierer .....	390
<i>Asciugacapelli, piastra e scaldacera</i>	
Haarstaubsauger · <i>Hair Vacuum</i> .....	394
Sterilisatoren · <i>Sterilizzatori</i> .....	395

## 02 Rasiermesser und rasierklingen 398 Rasoi e lame

RAGNAR Rasiermesser · <i>Rasoi RAGNAR</i> .....	399
BARBER LINE Rasiermesser · <i>Rasoi BARBER LINE</i> .....	401
CAPTAIN COOK Rasiermesser · <i>Rasoi CAPTAIN COOK</i> .....	405
EUROSTIL Rasiermesser · <i>Rasoi EUROSTIL</i> .....	407
FEATHER Rasiermesser und ihre Klingen .....	408
<i>Rasoi FEATHER e le loro lame</i>	
Rasierklingen · <i>Lame</i> .....	409
Einweg-Rasierer · <i>Rasoi usa e getta</i> .....	412
Pen razor, Rasierschaum und Rasiergel .....	413
<i>Pen razor, Schiume e Gel</i>	

## 03 Scheren Forbici 414

RAGNAR-Scheren · <i>Forbici RAGNAR</i> .....	416
CAPTAIN COOK-Scheren · <i>Forbici CAPTAIN COOK</i> .....	418
BARBER LINE-Scheren · <i>Forbici BARBER LINE</i> .....	421
EUROSTIL-Scheren · <i>Forbici EUROSTIL</i> .....	422
Azubi Scheren · <i>Forbici per studenti</i> .....	424
Spezielle Scheren für Linkshänder .....	425
<i>Forbici speciali per mancini</i>	

## 04 Bürsten und pinsel Spazzole e pennelli 426

Bartbürsten · <i>Pennelli da barba</i> .....	427
Talkum · <i>Talco</i> .....	429
BARBER LINE-Bürsten .....	430
<i>Pennelli BARBER LINE</i>	
EUROSTIL-Bürsten .....	434
<i>Spazzole EUROSTIL</i>	
CAPTAIN COOK Bürsten .....	435
<i>Spazzole CAPTAIN COOK</i>	

## 05 Kämme Pettini 436

RAGNAR Kämme · <i>Pettini RAGNAR</i> .....	437
CAPTAIN COOK Kämme · <i>Pettini CAPTAIN COOK</i> .....	440
BARBER LINE Kämme · <i>Pettini BARBER LINE</i> .....	441
EUROSTIL Kämme · <i>EUROSTIL Pettini</i> .....	442
Carbon Kämme · <i>Pettini in carbonio</i> .....	443
SILKOMB Kämme · <i>SILKOMB Pettini</i> .....	444
Kamm mit Wasserwage und Kammreiniger .....	445
<i>Pettine a bolla, e pulisci pettini</i>	

## 06 Kosmetik Cosmetici 446

CAPTAIN COOK .....	447
THE SHAVING CO .....	457
MR. BEAR FAMILY .....	461
OSMA .....	463
MYRSOL .....	464
LEGEND .....	469
TASSEL .....	470

## 07 Möbel und dekoration Complementi d'arredo 474

Barberpole · <i>Polo barber</i> .....	475
Barbierstuhl · <i>Poltrone</i> .....	476
Wachbecken · <i>Poltrone lavatesta</i> .....	481
Kinderstühle · <i>Poltrone per bambini</i> .....	483
Spiege · <i>Specchi</i> .....	485
Arbeitswagen und Tonnen · <i>Carrelli</i> .....	486
Empfangtheke und anderes .....	487
<i>Bancone reception e altri</i>	

## 08 Zubehör Accessori 490

Nackenpapier · <i>Carla collo</i> .....	491
Umkleideraum · <i>Abbigliamento</i> .....	493
LACLA Umkleideraum .....	498
<i>Abbigliamento LACLA</i>	
Sprühflasche · <i>Spruzzatore</i> .....	502
Koffer · <i>Valigie</i> .....	506
Handtuch · <i>Salviette</i> .....	508
Handtücher · <i>Asciugamani</i> .....	510
Desinfektionsmittel, Sterilisatoren, Spiegel, Besen .....	513
<i>Disinfettanti, Sterilizzanti, Specchi E Scope</i>	

## 09 Ausbildung Formazione 520

BERGMANN-Trainingsköpfe .....	521
<i>Teste studio bergmann</i>	
Trainingsköpfe BARBER LINE, EUROSTIL .....	522
<i>Teste studio barber line &amp; eurostil</i>	
Ständer und Stative · <i>supporti e treppiedi</i> .....	523

Die in diesem Katalog aufgeführten Preise sind empfohlene Preise, Steuern nicht inbegriffen.  
Die Preise gelten bis auf Tippfehler.  
Industrias Oriol 1942, S.L. behält sich das Recht vor, Änderungen ohne vorherige Ankündigung vorzunehmen.

*I prezzi indicati in questo catalogo sono prezzi consigliati ,iva esclusa.  
I prezzi saranno validi salvo errori tipografici.  
Industrias Oriol 1942, S.L. si riserva il diritto di apportare modifiche senza preavviso.*

01

# Elektrogeräte

BARBER E  
ACCESSORI

*Schneide- und Trimm Apparate,  
Rasierapparate, Trockner, Nasenhaartrimmer,  
Glätteisen, Fixierapparate...*

*Tagliacapelli, rasoi, asciugacapelli,  
tagliapel, piastre per la barba, scaldacera...*



**Haarschneider GALAXY FADING**  
**Tagliacapelli GALAXY FADING**

REF. 07220



NEW

» Spezial FADE  
» Special FADE

- » Bereit zum Verlassen
- » Ohne Klingenregelhebel
- » Feste Klinge einstellbar auf 0,2 - 0,3
- » Spannung: 100-240 V~
- » Frequenz: 50/60 Hz
- » Leistung: 8 W
- » 5500 rpm (+/-100)
- » Abbaugrad: 0,2 - 0,3 mm
- » Rasierklinge aus japanischem Stahl
- » Feste Rasierklinge aus Titan
- » Reinigungsbürste
- » Dose Schmieröl
- » Schutzbezug Rasierklinge
- » Netzteil
- » LCD-Multifunktions-Anzeige

- » Pronto per dissolvenza
- » Senza leva di regolazione della lama
- » Lama fissa regolabile a 0,2 - 0,3
- » Voltaggio: 100-240V~
- » Frequenza: 50/60Hz
- » Potenza: 8W.
- » 5500 r.p.m. (+/-100)
- » Grado di sfumatura: 0,2 - 0,3 mm
- » Lama in acciaio giapponese
- » Lama fissa in titanio
- » Pennellino per la pulizia.
- » Contenitore olio lubrificante
- » Protezione lama
- » Display LCD multifunzione

**Klinge · Lama**

REF.07389

**Haarschneider GALAXY CERAMIC**  
**Tagliacapelli GALAXY CERAMIC**

REF. 07221



NEW

» **KERAMIKKLINGE:** Reduziert die Erwärmung der Klinge  
» **LAMA IN CERAMICA:** riduce il riscaldamento della lama

- » Spannung: 100-240 V~
- » Frequenz: 50/60 Hz
- » Leistung: 8 W
- » 5500 rpm (+/-100)
- » Abbaugrad: 0,5 mm
- » Hebel zum Einstellen der Rasierklinge
- » RASIERKLINGE AUS KERAMIK und feste Rasierklinge aus Titan
- » 6 Kämme, anpassbar (1,5, 3, 4,5, 6, 10 und 13 mm).
- » Reinigungsbürste
- » Dose Schmieröl
- » Schutzbezug Rasierklinge
- » Netzteil
- » LCD-Multifunktions-Anzeige
- » Rasierklinge aus Keramik

- » Voltaggio: 100-240V~
- » Frequenza: 50/60Hz
- » Potenza: 8W.
- » 5500 r.p.m. (+/-100)
- » Grado di sfumatura: 0,5mm
- » Leva di regolazione
- » LAMA IN CERAMICA e lama fissa in titanio.
- » 6 rialzi (1,5 - 3,4,5,6,10 e 13 mm)
- » Pennellino per la pulizia.
- » Olio lubrificante
- » Protezione lama
- » Display LCD multifunzione
- » Lama in ceramica

» Ideal für lange Arbeitszeiten  
» Ideale per lavorare lunghe ore**Klinge · Lama**

REF.07388



**Tagliacapelli GALAXY**  
GALAXY hair clipper



REF. 06714

REF. 06714/50



- » Hebel zur Klingeneinstellung
- » Klinge aus japanischem Stahl
- » 6 Adapter Aufsätze (1,5, 3, 4,5, 6, 10 und 13 mm)
- » Schmierölbehälter
- » Reinigungsbürste
- » Klingenschutz
- » Netzteil
- » Multifunktions-LCD-Anzeige
- » Maximale Leistung: 8 W
- » Spannung: 100-240 V~
- » Frequenz: 50/60 Hz
- » Umdrehungen pro Minute: 5500+/-100 U/min
- » Abbaugrad: 0,5 mm

- » Leva di regolazione della lama
- » Lama in acciaio giapponese
- » 6 rialzi (1,5 - 3,4,5,6,10 e 13 mm mm)
- » Contenitore olio lubrificante
- » Pennellino per la pulizia
- » Protezione lama
- » Display LCD multifunzione
- » Potenza massima: 8 W.
- » Voltaggio: 100-240 V~
- » Frequenza: 50/60 Hz
- » Giri al minuto: 5500 +/- 100 rpm
- » Grado di sfumatura: 0,5mm

**Ersatzteile**  
Ricambi

**Kämme · Rialzi**

1,5 mm REF. RE06985/01



3 mm REF. RE06985/02



4,5 mm REF. RE06985/03



6 mm REF. RE06985/04



10 mm REF. RE06985/05



13 mm REF. RE06985/06



**Klinge · Lama**

» Flach REF. 06983  
» Piatta



» Standard REF. 06984  
» Standard



» Pack 6 Metallklingen  
» confezione di 6 rialzi in metallo REF. 06985



**Ersatzteile**  
**Ricambi**

<b>Kämme · Rialzi</b>	
1,5 mm	<b>REF. RE06985/01</b>
3 mm	<b>REF. RE06985/02</b>
4,5 mm	<b>REF. RE06985/03</b>
6 mm	<b>REF. RE06985/04</b>
10 mm	<b>REF. RE06985/05</b>
13 mm	<b>REF. RE06985/06</b>

**Klinge · Lama**

» Flach » Piatta		<b>REF. 06983</b>
» Standard » Standard		<b>REF. 06984</b>
» Pack 6 Metallklingen » confezione di 6 rialzi in metallo		<b>REF. 06985</b>

**Tagliacapelli SUPERNOVA**  
**SUPERNOVA hair clipper**

REF. 06715

REF. 06715/50



- » Hebel zur Klingeneinstellung
- » Klinge aus japanischem Stahl
- » 6 Adapter Aufsätze (1,5, 3, 4,5, 6, 10, 13 mm)
- » Schmierölbehälter
- » Reinigungsbürste
- » Klingenschutz
- » Netzteil
- » Turbo-Funktion
- » Multifunktions-LCD-Anzeige
- » Maximale Leistung: 8 W
- » Spannung: 100-240 V~
- » Frequenz: 50/60 Hz
- » Umdrehungen pro Minute: 5500+/-100 U/min
- » Turbo: 5700/-100 U/min
- » Abbaugrad: 0,5 mm

- » Leva di regolazione della lama
- » Lama in acciaio giapponese
- » 6 rialzi (1,5 - 3,4,5,6,10 e 13 mm mm)
- » Contenitore olio lubrificante
- » Pennellino per la pulizia
- » Protezione lama
- » Funzione turbo
- » Display LCD multifunzione
- » Potenza massima: 8 W.
- » Voltaggio: 100-240 V~
- » Frequenza: 50/60 Hz
- » Giri al minuto: 5500 +/- 100 rpm
- » Turbo: 5700/-100 rpm
- » Grado di sfumatura: 0,5mm

**Schneidemaschine BLACK SAM**  
*Tagliacapelli a filo Black Bart*



REF. 06334



- » Ohne Kabel
- » Enthält 6 Metallkämme und 2 Klingen
- » Spannung: 100-240 V~
- » Mit japanischen Stahlklingen
- » Frequenz: 50/60 Hz
- » Maximale Leistung: 5 W
- » Umdrehungen pro Minute: 5500+/-800 U/min
- » Adapter-Eingang: 0,2 A
- » Ausgang des Adapters: 5V ~600mA
- » Geeignet für alle natürlichen Haartypen
- » Abbaugrad: 0,5 mm

- » Senza cavo
- » include 6 rialzi in metallo e 2 lame
- » Voltaggio: 100-240 V~
- » Lame in acciaio giapponese
- » Frequenza: 50/60 Hz
- » Potenza massima: 5 W.
- » Giri al minuto: 5500+/-800 rpm
- » Ingresso trasformatore: 0,2 A
- » Uscita trasformatore: 5 V ~ 600 mA
- » Adatto a qualsiasi tipo di capello naturale
- » Grado di sfumatura: 0,5mm



**Ersatzteile**  
**Ricambi**

**Kämme · Rialzi**

1,5 mm REF. RE06454/01



3 mm REF. RE06454/02



4,5 mm REF. RE06454/03



6 mm REF. RE06454/04



9 mm REF. RE06454/05



12 mm REF. RE06454/06



- » Pack 6 Metallklingen
- » Confezione 6 rialzi in metallo

REF. 06454



**Klinge · Lama**

- » Standard REF. 06457
- » Standard



- » Flach REF. 06458
- » Piatta





### Ersatzteile Ricambi

<b>Kämme · Rialzi</b>	
1,5 mm	REF. RE06602/01
3 mm	REF. RE06602/02
4,5 mm	REF. RE06602/03
6 mm	REF. RE06602/04
9 mm	REF. RE06602/05
12 mm	REF. RE06602/06
» Pack 6 Metallklingen » Confezione di 6 rialzi in metallo REF. 06602	



### Klinge · Lama

» Standard » Standard <b>NEW</b>	REF. 07327	REF. 06603
<b>NEW</b>	REF. 07326	REF. 06604



### Schneidemaschine EAGLE Tagliacapelli a filo eagle

- » Mit Kabel 2,5 m
- » Enthält 6 Metallkämme und 2 Klingen
- » Mit japanischen Stahlklingen
- » Spannung: 220-240 V~
- » Frequenz: 50 Hz
- » Maximale Leistung: 10 W
- » Umdrehungen pro Minute: 6500+/-800 U/min
- » Geeignet für alle natürlichen Haartypen
- » Abbaugrad: 0,5 mm

- » Con cavo da 2,5 m
- » Include 6 rialzi in metallo e 2 lame
- » Lame in acciaio giapponese
- » Voltaggio: 220-240 V~
- » Frequenza: 50 Hz
- » Potenza massima: 10 W.
- » Giri al minuto: 6500+/-800 rpm
- » Adatto a qualsiasi tipo di capello naturale
- » Grado di sfumatura: 0,5mm



REF. 06390

### Schneidemaschine FALCON Tagliacapelli FALCON

- » Ohne Kabel
- » Enthält 6 Metallkämme und 2 Klingen
- » Mit japanischen Stahlklingen
- » Spannung: 100-240 V~
- » Frequenz: 50/60 Hz
- » Maximale Leistung: 5 W
- » Umdrehungen pro Minute: 5500+/-800 U/min
- » Adapter-Eingang: 0,2 A
- » Ausgang des Adapters: 5V 600mA
- » Geeignet für alle natürlichen Haartypen
- » Abbaugrad: 0,5 mm

- » Senza cavo
- » Include 6 rialzi in metallo e 2 lame
- » Lame in acciaio giapponese
- » Voltaggio: 100-240 V~
- » Frequenza: 50/60 Hz
- » Potenza massima: 5 W.
- » Giri al minuto: 5500+/-800 rpm
- » Ingresso trasformatore: 0,2 A
- » Uscita trasformatore: 5V 600mA
- » Adatto a qualsiasi tipo di capello naturale
- » Grado di sfumatura: 0,5mm



REF. 06391





**Schneidemaschine K-3600**  
**Tagliacapelli K-3600**



REF. 03752



REF. 03752/50



**Arbeitszeit**  
60 / 90 min  
*Autonomia*  
60/90 min



**Mit Batterie oder elektrischen Strom verwendbar**  
E' possibile utilizzarlo con batteira, o con filo



**5h Ladezeit**  
5 ore  
*tempo di ricarica*



**Keramikkopf und Titanklinge**  
*Testina in ceramica e lama in titanio*

- » Leistung: 5 W
- » Spannung: 200-240 V~
- » Frequenz 50 Hz
- » Ausgang des Adapters: 3V ~500 mA
- » Zubehör: 4 Kämme
- » Keramischer Schneidkopf mit einstellbarer Bewegung in der Schnittgröße
- » Feste Klinge aus Titan
- » Stromversorgungskabel
- » 2 wiederaufladbare Batterien
- » Reinigungsbürste
- » Schmieröl-Flasche

- » Potenza: 5 W.
- » Voltaggio: 200-240 V~
- » Frequenza 50 Hz
- » Uscita trasformatore: 3V ~ 500 mA
- » Accessori: 4 rialzi
- » Testina di taglio in ceramica con movimento regolabile per la misura del taglio
- » Lama fissa in titanio
- » 2 batterie ricaricabili
- » Pennellino per la pulizia
- » Olio lubrificante

**Ersatzteile**  
**Ricambi**

**Aufsatz · Testina**

REF. RE03752/01



**Kämme · Rialzi**

3 mm

REF. RE03752/07



6 mm

REF. RE03752/08



9 mm

REF. RE03752/09



12 mm

REF. RE03752/10



**Batterie · Batteria**

REF. RE03752/03



**Ersatzteile**  
**Ricambi****Aufsätze · Testina**

8 mm

REF. RE03753/06



30 mm

REF. RE03753/04



40 mm

REF. RE03753/05

» Nasenaufsatz  
» Testina per il naso

REF. RE03753/07

» Rasieraufsatz  
» Testina per la  
barba

REF. RE03753/08

**Kämme · Rialzi**

REF. RE03753/01

**Schneidemaschine K-3000**  
**Tagliacapelli K-3000**Professionelle Haarschneidemaschine zum  
Trimmen von Bart-, Nasen- und OhrenhaarenTagliacapelli professionale per ritocchi a barba, naso  
e orecchie

REF. 03753

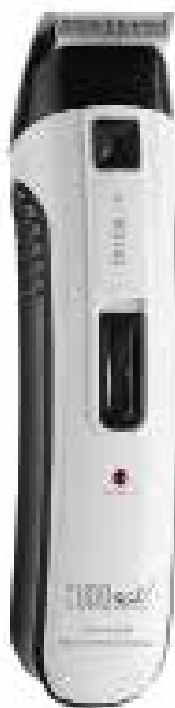

- » Leistung: 3 W
- » Klingen; 8, 30 und 40 mm.
- » Mit Aufsätzen für Nase/Ohren und Rasur
- » Auswechselbare Messer leicht zu reinigen
- » Niedrige Schwingung, sehr leise
- » LED Ladenanzeiger
- » Bis 60 min Betriebsdauer
- » Einstellbare Schnittlänge mit 4 Stufen; 3,6,9 u.12 mm

- » Potenza: 3 W.
- » Rialzi 8 mm, 30 mm, 40 mm per dettagli, testina naso/orecchie e testina di barba
- » Lama intercambiabile facile da pulire
- » Vibrazioni ridotte e molto silenziosa
- » Indicatore di carica a LED
- » Carica a lunga durata, fino a 60 minuti di autonomia
- » Lunghezza di taglio regolabile 4 livelli: 3mm, 6mm, 9mm e 12mm

**COSMIC-Trimmer**  
Tagliacapelli COSMIC



REF. 06713

REF. 06713/50



**Ersatzteile**  
Ricambi

- » 38-mm-Schneidkopf
- » Feste Klinge aus rostfreiem Stahl
- » Schnittgrößen-Adapter Aufsätze (2,3 und 4 mm)
- » Reinigungsbürste
- » Schmierölbehälter
- » Stromversorgungskabel
- » Ein/Aus-Taste
- » Multifunktions-LCD-Anzeige
- » Maximale Leistung: 5 W
- » Spannung: 100-240 V~
- » Frequenz: 50/60 Hz
- » Umdrehungen pro Minute: 5500+/-100 U/min

- » Testina di taglio da 38 mm
- » Lama fissa in acciaio inossidabile.
- » Rialzi (2,3 e 4 mm)
- » Spazzola per la pulizia
- » Olio lubrificante
- » Cavo di alimentazione
- » Pulsante di accensione e spegnimento
- » Display LCD multifunzione
- » Potenza massima: 5 W.
- » Voltaggio: 100-240 V~
- » Frequenza: 50/60 Hz
- » Giri al minuto: 5500 +/- 100 rpm

**Kämme · Rialzi**

2 mm



REF. RE06713/01

3 mm



REF. RE06713/02

4 mm



REF. RE06713/03

Trimmer T-Null Klinge  
Lama Trimmer T-zero



REF.06982

**Ersatzteile**  
**Ricambi****Kämme · Rialzi****NEW**

1 mm

REF. RE06667/05



2 mm

REF. RE06667/06



3 mm

REF. RE06667/07

» Mit  
Stellschrauben  
» Con viti regolabili

REF. RE06667/01

**TRIUMPH Trimmer**  
**Tagliacapelli da rifinitura TRIUMPH**

REF. 06667



- » Ohne Kabel
- » 38-mm-Schneidekopf
- » Feste Klinge aus rostfreiem Stahl
- » Adapterkamm für Schnittgröße (1,2 und 3 mm)
- » Pack 6 Metallkämmen
- » Reinigungsbürste
- » Schmierölbehälter
- » Stromversorgungskabel
- » **LADESTATION**
- » Ein/Aus-Taste
- » Maximale Leistung: 10W
- » Spannung: 100-240V~
- » Frequenz: 50/60Hz
- » Umdrehungen pro Minute: 5500+/-800 U/min
- » Abbaugrad: 0,1 mm

- » Senza cavo
- » Testina di taglio da 38 mm
- » Lama fissa in acciaio inossidabile.
- » Adattatore a pettine per regolazione del taglio (1,2 e 3 mm)
- » Confezione di 6 rialzi in metallo
- » Pennellino per la pulizia
- » Olio lubrificante
- » **BASE DI RICARICA**
- » Pulsante ON-OFF
- » Potenza massima: 10W.
- » Voltaggio: 100-240V~
- » Frequenza: 50/60Hz
- » Giri al minuto: 5500+/-800 rpm
- » Grado di sfumatura: 0,1mm

**01**

ELEKTROGERÄTE · BARBER E ACCESSORI

CAPTAIN COOK Schneidemaschinen · Tagliacapelli CAPTAIN COOK

**THUNDER Trimmer**  
Taglia capelli da rifinitura THUNDER

REF. 06666

**Ersatzteile**  
Ricambi**Kämme · Rialzi**

1,5 mm



REF. RE06602/01

3 mm



REF. RE06602/02

4,5 mm



REF. RE06602/03

6 mm



REF. RE06602/04

9 mm



REF. RE06602/05

12 mm



REF. RE06602/06

» Pack 6 Metallklingen  
» Pack di 6 rialzi in metallo

REF. 06602

**Klinge · Lama**

» Standard

REF. 07327

REF. 06603

» Standard

**NEW**

» Flach

REF. 07326

REF. 06604

» Piatta

**NEW**

- » Hebel zur Klingeneinstellung
- » 2 japanische Stahlklingen
- » 6 Adapter Aufsätze (1,5, 3, 4,5, 6, 10, 12 mm)
- » Reinigungsbürste
- » Schmierölbehälter
- » Klingenschutz
- » Maximale Leistung: 10W
- » Spannung: 100-240V~
- » Frequenz: 50/60Hz
- » Umdrehungen pro Minute: 5500+/-800 U/min
- » Abbaugrad: 0,5 mm
- » **LADEGERÄT**

- » Leva di regolazione della lama
- » 2 lame in acciaio giapponese
- » 6 rialzi (1,5, 3, 4,5, 6, 10, 12 mm).
- » Pennellino per la pulizia
- » Olio lubrificante
- » Protezione lama
- » Potenza massima: 10W.
- » Voltaggio: 100-240V~
- » Frequenza: 50/60Hz
- » Giri al minuto: 5500+/-800 rpm
- » Grado di sfumatura: 0,5mm
- » **BASE DI RICARICA**



**Pack Nr. 1 "5. Jahrestag" CAPTAIN COOK**  
**Pack n°1 "5° Anniversario" CAPTAIN COOK**

REF. 07276

**NEW**

Enthält:

- » Bürste Fade - 04977
- » Effilierschere Black Ripper 6" - 06479
- » Haarschneider Thunder - 06666
- » Necessaire Captain Cook - 07079

Contiene:

- » Spazzola Fade - 04977
- » Forbici black ripper per scopire 6" - 06479
- » Tagliacapelli Thunder - 06666
- » Borsa da toilette Captain Cook - 07079

**Pack Nr. 2 "5. Jahrestag" CAPTAIN COOK**  
**Pack n°2 "5° Anniversario" CAPTAIN COOK**

REF. 07330

**NEW**

Enthält:

- » Haarschneider Thiumph - 06667
- » Bürste Fade - 04977
- » Effilierschere Black Ripper 6" - 06479
- » Necessaire Captain Cook - 07079

Contiene:

- » Tagliacapelli Trhiumph - 06667
- » Spazzola Fade - 04977
- » Forbici per scolpire 6" Black ripper - 06479
- » Borsa da toilette Captain Cook - 07079

**Haartrimmer AIRFLIP**  
Taglia capelli da rifinitura AIRFLIP



REF. 07282



Ansicht Schnitt der  
Rasierklinge  
Visione taglio

NEW



**Ersatzteile**  
Ricambi

**Kämme · Rialzi**



1 mm

REF. RE0782/01



2 mm

REF. RE0782/02



3 mm

REF. RE0782/03



**Klinge · Lama**

REF.07324



- » Spannung: 100-240 V~
- » Frequenz: 50/60 Hz
- » Leistung: 8 W
- » 6500 rpm (+/-500)
- » Schneidkopf von 38 mm
- » Schutzbezug für Rasierklinge.
- » Feste Rasierklinge aus Edelstahl
- » Kamm-Adapter für das Schnittmaß (1, 2 und 3 mm)
- » Reinigungsbürste
- » Dose Schmieröl
- » Netzkabel
- » **LADEGERÄT**
- » Transparenter Deckel
- » Abbaugrad: 0,1 mm

- » **Voltaggio:** 100-240V~
- » **Frequenza:** 50/60Hz
- » **Potenza:** 8W.
- » 6500 r.p.m. (+/-500)
- » **Testina di taglio da 38 mm**
- » **Protezione lama**
- » **Lama fissa in acciaio inossidabile.**
- » **Rialzi (1,2 e 3mm)**
- » **Pennellino per la pulizia.**
- » **Contenitore olio lubrificante**
- » **BASE DI RICARICA.**
- » **Grado di sfumatura: 0,1mm**



## Haartrimmer DRAKE

### Taglia capelli da rifinitura DRAKE



REF. 07283



Ansicht Schnitt der  
Rasierklinge  
Visione taglio

### Ersatzteile Ricambi

#### Klinge · Lama

REF.07325



NEW



- » Spannung: 100-240 V~
- » Frequenz: 50/60 Hz
- » Leistung: 8 W
- » 7000+/-500 rpm
- » Schneidkopf von 38 mm
- » Feste Rasierklinge aus Edelstahl
- » Kamm-Adapter für Schnittmaß (1, 2 und 3 mm).
- » Reinigungsbürste
- » Dose Schmieröl
- » Netzkabel
- » Transparenter Deckel
- » Abbaugrad: 0,1 mm

- » Voltaggio: 100-240V~
- » Frequenza: 50/60Hz
- » Potenza: 8W.
- » 7000+/-500 rpm.
- » Testina di taglio da 38 mm.
- » Lama fissa in acciaio inossidabile.
- » Rialzi (1,2 e 3mm)
- » Pennellino per la pulizia
- » Olio lubrificante
- » Grado di sfumatura: 0,1mm





**COMET-Rasierer**  
**COMET**



Vielen Dank, dass Sie sich für unseren neuen wiederaufladbaren Bartrasierer COMET 07084/50 - 07084/54 von "RAGNAR" entschieden haben, der für den professionellen Einsatz konzipiert ist. Leistungsstarker und langlebiger Motor, superleise und vibrationsarm. Hergestellt aus qualitativ hochwertigen Materialien und der letzten Generation.

Grazie per aver scelto il nostro nuovo rasoio ricaricabile COMET 07084/50 - 07084/54 di RAGNAR progettato per un uso professionale. Motore potente e di lunga durata, super silenzioso e a basse vibrazioni. Realizzato con materiali di alta qualità e di ultima generazione.



REF. 07084/50



REF. 07084/54



- » Spannung: 100-240V~
- » Frequenz: 50/60Hz
- » Leistung : 5W
- » Umdrehungen pro Minute: 8.000-9.000 U/min
- » Adapter-Eingang: : 0,2 A
- » Ausgang des Adapters: 5V 1000mA
- » Aufladezeit: 3 Stunden
- » Betriebsdauer: mehr als 80 Minuten
- » Lithium-Batterie
- » Geeignet für alle natürlichen Haartypen
- » Ideale Umgebungsbedingungen für den Einsatz: Verwendung in Innenräumen
- » Temperatur -5° bis 40°C
- » Relative Luftfeuchtigkeit gleich oder weniger als 80

- » Voltaggio: 100-240V~
- » Frequenza: 50/60Hz
- » Potenza: 5W.
- » Giri al minuto: 8.000/9.000 rpm
- » Ingresso trasformatore: : 0,2 A
- » Uscita trasformatore: 5V 1000mA
- » Tempo di ricarica: Tre ore
- » autonomia: piu di 80 minuti
- » Batteria al litio
- » Adatto a qualsiasi tipo di capello naturale
- » Condizioni ambientali ideali per l'uso: uso interno
- » Temperatura da -5° a 40°C
- » Umidità relativa uguale o inferiore all'80%

**Ersatzteile**  
**Ricambi**

**Kompletter Aufsatz mit Klinge**  
**Testina completa con lama**

- » Schwarz
- » Nero



REF. RE07084/50/01



- » Schwarz
- » Grigio



REF. RE07084/54/01



**Bucanero-Rasierer****Rasoio elettrico Bucanero**

BUCANERO Bart-Rasierer, mit wiederaufladbarer "Barber Line"-Batterie, konzipiert für den professionellen Einsatz. Leistungsstarker und langlebiger Motor, superleise und vibrationsarm. Hergestellt aus qualitativ hochwertigen Materialien und der letzten Generation

*Rasoio per barba BUCANERO, con batteria ricaricabile di "Barber Line", progettato per uso professionale. Motore potente e di lunga durata, super silenzioso e a basse vibrazioni. Realizzato con materiali di alta qualità e di ultima generazione.*



REF. 06412/50



- » Spannung: 100-220 V~
- » Frequenz: 50/60 Hz
- » Leistung: 3 W
- » Umdrehungen pro Minute: 6800 U/min
- » Adapter-Eingang: 3-5 W
- » Leistung des Adapters: 2 W
- » Aufladezeit: 2 Stunden
- » Betriebsdauer: mehr als 90 Minuten
- » Lithium-Batterie
- » Geeignet für alle natürlichen Haartypen

- » Voltaggio: 100-220 V~
- » Frequenza: 50/60 Hz
- » Potenza: 3 W.
- » Giri al minuto: 6800 rpm
- » Ingresso trasformatore: 3-5 W
- » Uscita trasformatore: 2 W.
- » Tempo di ricarica: 2 ore
- » Autonomia: più di 90 minuti
- » Batteria al litio
- » Adatto a qualsiasi tipo di capello naturale

### Ersatzteile Ricambi

#### Kompletter Aufsatz mit Klinge Testina completa con lama



- » Grau
- » Grigio



REF. RE06412/01

- » Schwarz
- » Nero



REF. RE06412/50/01



## Roadster-Rasierer

### Rasoio elettrico Roadster



ROADSTER Bart-Rasierer, mit wiederaufladbarer Batterie "Captain Cook", konzipiert für den professionellen Einsatz. Leistungsstarker und langlebiger Motor, superleise und vibrationsarm. Hergestellt aus qualitativ hochwertigen Materialien und der letzten Generation.

*Rasoio per barba ROADSTER, con batteria ricaricabile di "Captain Cook", progettato per uso professionale. Motore potente e di lunga durata, super silenzioso e a basse vibrazioni. Realizzato con materiali di alta qualità e di ultima generazione.*

REF. 06411



- » Spannung: 100-220 V~
- » Frequenz: 50/60 Hz
- » Leistung : 3 W
- » Umdrehungen pro Minute: 6800 U/min
- » Adapter-Eingang: 3-5 W
- » Leistung des Adapters: 2 W
- » Aufladezeit: 2 Stunden
- » Betriebsdauer: mehr als 90 Minuten
- » Lithium-Batterie
- » Geeignet für alle natürlichen Haartypen

- » Voltaggio: 100-220 V~
- » Frequenza: 50/60 Hz
- » Potenza: 3 W.
- » Giri al minuto: 6800 rpm
- » Ingresso trasformatore: 3-5 W
- » Uscita trasformatore: 2 W.
- » Tempo di ricarica: 2 ore
- » Autonomia: piu di 90 minuti
- » Batteria al litio
- » Adatto a qualsiasi tipo di capello naturale

### Ersatzteile

#### Ricambi

#### Kompletter Aufsatz mit Klinge

#### Testina completa con lama



REF. RE06411/01

**Eurostil Nasentrimmer**  
**Tagliapeli Eurostil**Batterie nicht enthalten  
Batteria non inclusa

- » Kann nass werden
- » Mit Sockel und 2 Zubehörteilen

REF. 04268

- » Kann nicht nass werden
- » Non può entrare in contatto con l'acqua

REF. 04269

- » Può entrare in contatto con l'acqua
- » Con base e 2 accessori

**Trimmer**  
**Tagliapeli per ritocchi**Batterie nicht enthalten  
Batteria non inclusa

- » Ergonomische Gestaltung
- » Sanft zu empfindlicher Haut
- » Ein/Aus-Schalter
- » 2 Schnittebenen: für 2 mm Länge / für 5 mm Länge
- » Schutzkappe
- » Abgewinkelter Kopf für einfache Bedienung
- » Netzteil
- » 1 AAA-Batterie (nicht enthalten)

REF. 04270

- » Batteria non inclusa
- » Design ergonomico
- » Delicato sulla pelle sensibile
- » Interruttore on/off
- » 2 livelli di taglio: per 2 mm di lunghezza / per 5 mm di lunghezza
- » Coperchio di protezione
- » Testina angolata per un facile utilizzo
- » Alimentazione elettrica
- » 1 batteria AAA (non inclusa)



## Maschinenöl

### Olio per tagliacapelli



Maschinenöl für den professionellen Einsatz. Kältemittel, desinfizierend, Schmiermittel und Antioxidationsmittel. Unverzichtbar für eine optimale Wartung der Klingen. Sprühen Sie in einem Abstand von ca. 15-20 cm seitlich auf den oberen Aufsatz.

Olio per tagliacapelli ad uso professionale. Refrigerante, igienizzante, lubrificante e antiossidante. Indispensabile per una manutenzione ottimale della lama. Spruzzare a una distanza di circa 15-20 cm dalla parte superiore della testina di taglio.

» Intensives Parfüm  
» Profumo intenso



500 ml

REF. 06272

» Sanftes Parfüm  
» Profumo delicato



500 ml

REF. 06395



## Flasche Öl

### Flacone di olio lubrificante



Bei diesem Spezialöl für Schneidemaschinen der Marke Eurostil handelt es sich um ein leichtes Mineralöl, das die Hubzeit der Klinge und damit den Schnitt der Klinge verbessert. Nicht irritierend.

Questo olio speciale per macchine da taglio di Eurostil è un olio minerale leggero che migliora i tempi di movimento della lama, migliorando così il taglio. Non irrita

» Zum schmieren  
» Lubrificante



100 ml

REF. 03751

## CLIPP-AID-Aussteller

### Espositore CLIPP-AID



» Nur für Stahlklingen  
» Kristalle zum Schärfen der Klinge

» Solo per lame in acciaio  
» Cristalli per affilare le lame



Enthält 18 xref.  
Päckchen (04571  
und 04572)

Contiene 18 pacchetti  
(Rif. 04571 e 04572)

**Fussmatte für friseursalons RAGNAR**  
**Tappetino barber RAGNAR**1  
u.m.vta12  
box

REF. 07386

- » Material: Gummi
- » Materiale: Gomma

**Fussmatte für friseursalons CAPTAIN COOK**  
**Tappetino barber CAPTAIN COOK**1  
u.m.vta12  
box

REF. 07387

- » Material: Gummi
- » Materiale: Gomma



## Compact Profi-Föhn

### Asciugacapelli professionale compatto



Der Kompakt-Profi-Föhn hat ein attraktives, ergonomisches und leichtes Design. Erhältlich in schwarz und weiß mit farbigen Gummibesatz. Leistungsstarker Motor mit Ionengenerator. Enthält zwei Düsen unterschiedlicher Größe.

*L'asciugacapelli professionale Compact ha un design accattivante, ergonomico e leggero. Disponibile in bianco e nero con dettagli colorat. Potente motore con generatore di ioni. Include due bocchette di dimensioni diverse.*

REF. 04202



21,5 cm



- » Leistung: 2000 W
- » Kompakter AC-Motor mit langer Lebensdauer
- » Gewicht: 580 gr
- » Luftdurchsatz: 90 m<sup>3</sup>/Stunde
- » 2 Geschwindigkeiten, 3 Temperaturen
- » Kaltluft-Knopf
- » 2 verstellbare Düsen von 62 mm und 70 mm
- » Herausnehmbarer Filter
- » Sicherheitsthermostat
- » Flexibles Kabel 3m mit Ring zum Aufhängen
- » Spannung 220-240V~
- » Frequenz: 50/60 Hz
- » Niedriger Geräuschpegel (70db)
- » Ergonomische Gestaltung
- » Robustes und leichtes Polyamid-Gehäuse
- » Anti-Rutsch-Gummibesatz
- » Ionengenerator-Motor

- » Potenza: 2000 W.
- » Motore compatto di lunga durata AC
- » Peso: 580 gr
- » Flusso d'aria: 90 m<sup>3</sup>/ora
- » 2 velocità, 3 temperature
- » Pulsante aria fredda
- » 2 bocchette regolabili da 62 mm e 70 mm
- » Filtro rimovibile
- » Termostato di sicurezza
- » Cavo flessibile da 3m con anello per appendere
- » Voltaggio 220-240V~
- » Frequenza: 50/60 Hz
- » Basso impatto acustico (70db)
- » Design ergonomico
- » Alloggiamento in poliammide robusto e leggero
- » Rivestimento in gomma antiscivolo
- » Motore generatore di ioni

**Compact Extra Light Föhn**  
**Asciugacapelli Compact Extra Light**



Der Compact Professional Extra Light Föhn hat ein attraktives, ergonomisches und leichtes Design. Erhältlich in schwarz und weiß mit farbigen Gummibesatz. Leistungsstarker Motor mit Ionengenerator. Enthält zwei Düsen unterschiedlicher Größe.

*L'asciugacapelli professionale Compact Extra Light ha un design accattivante, ergonomico e leggero. Disponibile in bianco e nero con dettagli colorati. Potente motore con generatore di ioni. Include due bocchette di dimensioni diverse.*

REF. 04203

REF. 04203/58



21,5 cm



21,5 cm



- » Leistung: 1800 W
- » Gleichstrommotor
- » Gewicht: 430 gr
- » Luftdurchsatz: 76 m<sup>3</sup>/Stunde
- » 2 Geschwindigkeiten, 3 Temperaturen
- » Kaltluft-Knopf
- » 2 verstellbare Düsen von 62 mm und 70 mm
- » Herausnehmbarer Filter
- » Sicherheitsthermostat
- » Flexibles Kabel 3m mit Ring zum Aufhängen
- » Spannung 220-240 V~
- » Frequenz: 50/60 Hz
- » Kompakt und extra leicht
- » Anti-Rutsch-Gummibesatz
- » Sehr niedriger Geräuschpegel
- » Motor mit Ionengenerator

- » Potenza: 1800 W.
- » Motore DC
- » Peso: 430 gr
- » Flusso d'aria: 76 m<sup>3</sup>/ora
- » 2 velocità, 3 temperature
- » Pulsante aria fredda
- » 2 bocchette regolabili da 62 mm e 70 mm
- » Filtro rimovibile
- » Termostato di sicurezza
- » Cavo flessibile da 3m con anello per appendere
- » Voltaggio 220-240 V~
- » Frequenza: 50/60 Hz
- » Compatto e PIÙ LEGGERO
- » Rivestimento in gomma antiscivolo
- » Molto silenzioso
- » Potente motore con generatore di ioni.



## Robust Barber Line Föhn

### Asciugacapelli Robust di Barber Line



Hergestellt als ideale Ergänzung für den Friseur. Der neue Haartrockner ROBUST von Barber Line bietet einen hohen Luftstrom, erhöhte Leistung und verkürzte Trocknungszeit. Sie erlaubt es, jede Art von Frisur zu erstellen: geglättet, gewellt, Volumen, usw. Ihr Haar wird weich, glänzend und gesund aussehen.

*Progettato come accessorio ideale per il parrucchiere. Il nuovo asciugacapelli ROBUST di Barber Line offre un flusso d'aria elevato, prestazioni migliorate e tempi di asciugatura ridotti. Ti consente di creare qualsiasi tipo di acconciatura: liscia, ondulata, voluminosa, ecc. I capelli appariranno lisci, lucenti e sani.*

- » Leistung: 1900W - 2200W
- » Spannung 220-240V~
- » Frequenz: 50/60 Hz

REF. 06475

- » Potenza: 1900W - 2200W
- » Voltaggio 220-240V~
- » Frequenza: 50/60 Hz



19 cm



Estilismo/ Fotografia: Pugilato · Styling / Photography: Pugilato

### Barber Line schwarzes Wachs Fixiergerät 125 ml Scaldacera nero Barber Line 125 ml



REF.04505

- » Kompakte Wachsschmelze
- » Antihaft-Oberfläche für einfache Reinigung
- » Variable Temperatureinstellungen
- » Schnelles Aufheizen
- » Schutzdeckel
- » Fassungsvermögen: 125 ml
- » Spannung: 220-240V~
- » Leistung: 40 W
- » Frequenz: 50 Hz
- » Maximale Temperatur 90°C

- » *Scaldacera compatto*
- » *Superficie antiaderente per una facile pulizia*
- » *Regolazione della temperatura*
- » *Riscaldamento rapido*
- » *Coperchio di protezione*
- » *Capacità: 125 ml*
- » *Voltaggio: 220-240V~*
- » *Potenza: 40 W.*
- » *Frequenza: 50 Hz*
- » *Temperatura massima 90°C*



### Kleines Glätteisen Barber Line für Bart und Pony Mini piastra Barber Line per barba e frangia

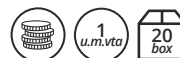

Mit den neuen Mini-Friseur-Haarglätteisen der letzten Generation können Sie jede Art von welliger oder glatter Frisur usw. erstellen. Professionelle Nutzung.

*Le nuove mini piastre Barber Line di ultima generazione consentono di creare qualsiasi tipo di acconciatura ondulata, liscia, ecc. Uso professionale.*

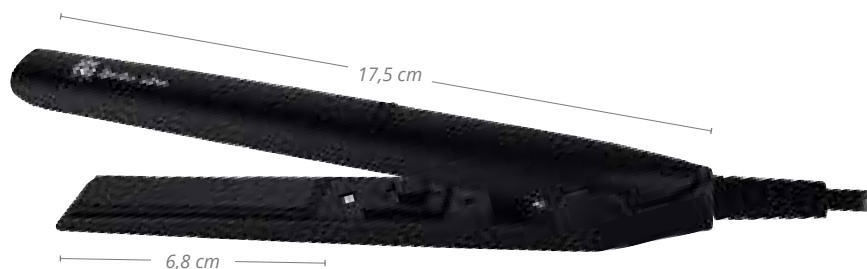

REF. 06569/50

- » Keramikplatten mit Turmalin, die das Haar pflegen und ihm Glanz und Geschmeidigkeit verleihen
- » Spannung 100-240V~
- » Frequenz: 50/60 Hz
- » Leistung 22 W
- » 2 m langes Kabel mit Gummi
- » Aufheizen der Platten in nur 30 Sekunden, mit PTC-Widerstand
- » Maximale Temperatur 200°C
- » PTC-Widerstand verhindert Überhitzung
- » Geeignet für alle natürlichen Haartypen
- » NICHT FÜR KUNSTHAAR VERWENDEN
- » NICHT FÜR NASSES HAAR GEEIGNET

- » *Piastre in ceramica con tormalina donando lucentezza e morbidezza*
- » *Voltaggio 100-240V~*
- » *Frequenza: 50/60 Hz*
- » *Potenza 22 W.*
- » *Cavo in gomma lungo 2 m*
- » *Riscaldamento della piastra in soli 30 secondi, con resistenza PTC*
- » *Temperatura massima 200°C*
- » *Resistenza PTC che impedisce il surriscaldamento*
- » *Adatta a qualsiasi tipo di capello naturale*
- » *NON USARE SU CAPELLI SINTETICI*
- » *NON ADATTA A CAPELLI BAGNATI*



**Haarstaubsauger**  
**Aspiratore per capelli**

HAIR VACUUM Haarsauger neuester Technologie, entwickelt, um den Arbeitsprozess des Fachmanns zu erleichtern. Zwei Funktionsarten: 1. MANUELLER MODUS: besteht aus einem manuellen Aktivierungsknopf mit einer Dauer von 5 Sekunden. Ermöglicht die Entfernung derin die Nähe geschobener Haarreste, indem sie mit Hilfe des manuellen Aktivierungsknopfes, der je nach Menge und Art der erzeugten Haarrestemehrmals aktiviert werden muss, in die Nähe der Basis der Einheit gebracht wird. 2. AUTO-MODUS: dank der Leistung seiner Sensoren, die sich an der Basis des Geräts befinden, ermöglicht er die Erkennung und Beseitigung der erzeugten Haarreste, was die Arbeit des Fachmanns erleichtert. Es startet automatisch einen Absaugzyklus, der endet, sobald die Sensoren keine Haarrestemehr erkennen.

HAIR VACUUM Aspiratore di ultima tecnologia, progettato per facilitare il processo di lavoro del professionista. Due posizioni operative: 1. MODALITÀ MANUALE: consiste in un pulsante di attivazione manuale per una durata di aspirazione di 5 secondi. Permette di rimuovere i rifiuti avvicinando la base dell'apparecchio con l'ausilio del pulsante di attivazione manuale che dovrà essere attivato più volte a seconda della quantità e del tipo di rifiuti generati. 2. MODALITÀ AUTO: grazie alla potenza dei suoi sensori posti alla base dell'unità, permette di rilevare ed eliminare i rifiuti generati facilitando così il lavoro del professionista. Avvia automaticamente un ciclo di aspirazione, che terminerà quando i sensori non rileveranno più rifiuti.



- » Nennleistung: 1400 W
- » Modell: VA001A-BK
- » Nennspannung: 220-240V~
- » Frequenz: 50/60Hz
- » Größe: (Länge x Breite x Höhe): 33 cm Länge x 21 Breite x 56,4 cm Höhe
- » Nettogewicht: etwa 5,1Kg
- » Betriebsgeräusch: ≥83db 1,5m
- » Automatischer Arbeitsmodus: Infrarotererkennung
- » Saugleistung (Zugkraft): ≥2,8 Kg
- » Fassungsvermögen des Auffangbehälters: 2,7L MAX
- » Netzkabel Länge: 2m

- » Potenza nominale: 1400 W.
- » Modello: VA001A-BK
- » Voltaggio nominale: 220-240V~
- » Frequenza: 50/60Hz
- » Dimensioni: (lunghezza x larghezza x altezza): 33 cm di lunghezza x 21 di larghezza x 56,4 cm di altezza
- » Peso netto: circa 5,1kg
- » Rumore di funzionamento: ≥83db 1,5 m
- » Modalità di lavoro automatica: introduzione di radiazione infrarossa
- » Aspirazione (forza di trazione): ≥2,8 Kg
- » Capacità del serbatoio dell'immondizia: 2,7 L MAX
- » Dimensioni del cavo di alimentazione: 2m

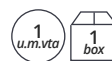
**Eurostil UVSterilisor Aluminium**  
**Sterilizzatore Eurostil UV in alluminio**

- » Leistung: 8W
- » Geeignet für die Sterilisation von kleinen Utensilien aus Kunststoff oder Metall mit Hilfe einer keimtötenden UV-Strahlenlampe.
- » Nicht für andere Gegenstände verwenden.
- » Die Lampe hält etwa 1300/1500 Stunden (= 1 Jahr Betriebsdauer).

- » Potenza: 8W.
- » Indicato per la sterilizzazione di piccoli utensili in plastica o metallo mediante una lampadina UV germicida.
- » Non utilizzare con altri oggetti non indicati.
- » La lampadina dura circa 1300/1500 ore (= 1 anno di funzionamento).

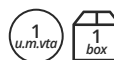

REF. 03317

**Sanity Security Heissluft Sterilisor**  
**Sterilizzatore a calore secco Sanity Security**

- » Leistung: 8W
- » 20° - 200°C
- » Innenmaße: 25 cm x 14,5 cm x 7 cm

- » Potenza: 8W.
- » 20° - 200°C
- » Misure interne: 25 cm x 14,5 cm x 7 cm

REF. 03011



**EUROSTIL-Quarz-Sterilisator**  
**S terilizzatore a quarzo EUROSTIL**

REF. 07013

- » Quarz
- » Ideal für Metallutensilien wie Käämme, Scheren usw.
- » Enthält eine Tüte mit Kugeln

- » Quarzo
- » Ideale per utensili in metallo come pettini e forbici, etc.
- » Include un sacchetto di sfere

**Dose mit Quarzkugeln 500 gr**  
**Contentore di sfere di quarzo 500 gr**

REF. 06619

Zur Sterilisation von Metallwerkzeugen für  
Friseur- und Kosmetikbedarf

- » Leistung: 400W
- » 20°C - 200°C

Per sterilizzare strumenti in metallo sia per  
parrucchieri che per estetisti

- » Potenza: 400W.
- » 20°C - 200°C



**Keimtötender Sterilisator GX4**  
**Sterilizzatore germicida GX4**

- » Leistung: 15W
- » Ultraflach. Hochwertiges keimtötendes Licht

- » Potenza: 15W.
- » Ultra piatto. Luce germicida di alta qualità

REF. 03009/59

**Eurostil UV- Sterilisator Kunststoff-**  
**Sterilizzatore Eurostil UV in plastica**

Ultraviolett-Sterilisator für alle Arten von Werkzeugen sowohl für die Friseur- als auch für die Schönheitspflege

REF. 06618

*Sterilizzatore ultravioletto per tutti i tipi di strumenti, sia per parrucchieri che per estetisti*

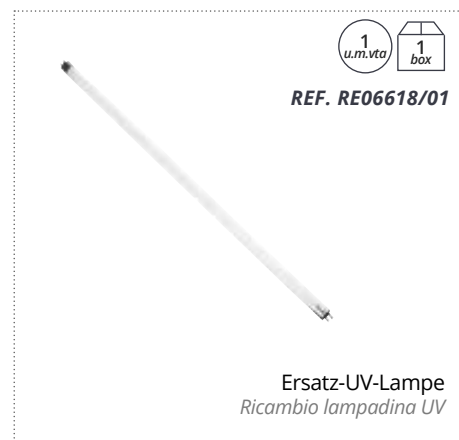

02

# Rasiermesser und rasierklingen

RASOI E LAME

*Rasiermesser, Messer, Rasierstifte,  
Schäume und Gele...*

*Rasoi, lamette, pen razor,  
schiume e gel ...*



**Rasiermesser REFINED**  
**Rasoio a mano libera REFINED**1  
u.m.vta12  
box**NEW**

- » Messung: 14,5 cm
- » Für Einschneidige Klinge Wellblech
- » STAHL J2 HOCHWERTIG (420C)
- » Logo mit Laser graviert

- » Misura: 14,5 cm
- » Per lametta a taglio unico ondulata
- » ACCIAIO J2 DI ALTA QUALITÀ (420C)



REF.07163

- » Schwarz
- » Nero



- » Silber
- » Argento



REF.07161

- » Altes Kupfer
- » Vecchio rame



REF.07162





**Rasiermesser PRECISE**  
**Rasoio a mano libera PRECISE**

1 u.m.vta 100 box

- » Ideal zum Trimmen und zum Rasieren
- » Halbklinge gerillt
- » Griff schwarz
- » Maße: 15 x 2,6 x 1,1 cm
- » Mit Platinbad für ein besseres Rasieren und Trimmen

- » Ideale per ritocchi e rasatura
- » Mezza lametta ondulata
- » Manico nero
- » Misure: 15 x 2,6 x 1,1 cm
- » Placcato platino per rasatura e ritocco migliori



NEW

REF.07124

15 cm



**RAGNAR-Messer mit schwarzem Metallgriff**  
**Rasoio RAGNAR con manico in metallo nero**

1 u.m.vta 25 box

Sehr leichtes Rasiermesser mit schwarzem Griff zum Rasieren und Trimmen von Bärten und Haaren  
*Rasoio leggerissimo per rasatura e ritocchi a barba e capelli con manico in metallo nero*

REF.06986



- » Einschneidige Klinge
- » Mezza lama.

23 cm



## Klassischer Rasierhobel für Rasierklingen

### Rasoio classico

*Barber Line*

Klassischer, zweischneidiger Rasierer für Rasierklingen, ein unverzichtbares Werkzeug für den Barbier. Das Rasiermesser aus rostfreiem Stahl hat einen gerillten Griff für einen besseren Halt. Geeignet für Anfänger. Geeignet für alle auf dem Markt erhältlichen zweischneidigen Klingen.

*Rasoio classico, con lama intera e a doppio taglio, uno strumento essenziale per il barbiere. Il rasoio ha un manico in acciaio inossidabile strutturato per offrire una presa migliore. Adatto ai principianti. Adatto a qualsiasi lametta a doppio taglio disponibile sul mercato.*

- » Zweischneidige Klinge
- » Lama intera a doppio taglio



REF.04929

- » Zweischneidige Klinge
- » Lama intera a doppio taglio



REF.04550



- » Zweischneidige Klinge
- » Lama intera a doppio taglio



REF.04933



## Klassischer Rasierhobel für Rasierklingen

### Rasoio classico



Klassischer Rasierer mit zweischneidiger Klinge und Kunststoffgriff für einen besseren Halt. Inklusive einer eleganten Box

REF.04931

*Rasoio classico con lama a doppio taglio e manico in plastica per offrire una presa migliore. Include una elegante custodia*

- » Zweischneidige Klinge
- » Lama intera a doppio taglio



Rasieren kann zu einem Akt des Luxus und einer gewissen Genuss werden. Mit der Barber Line von Eurostil, die auf mehr als 75 Jahre Erfahrung in der Friseurwelt zurückblickt, haben wir diese Produktreihe für den modernen Mann mit der Eleganz der Vergangenheit geschaffen.

*La rasatura può diventare un lusso da veri intenditori. Con la linea Barber di Eurostil, grazie a più di 75 anni di esperienza nel mondo nel mondo barber, abbiamo creato questa linea di prodotti per l'uomo moderno con l'eleganza di un tempo.*

### Rasiermesser mit Holzgriff

Rasoio a mano libera con manico in legno



- » Einschneidige Klinge. Wechselbar
- » Lama a taglio unico. Intercambiabile

REF. 04930



### Rasiermesser mit Kunststoffgriff

Rasoio a mano libera con manico in plastica



- » Zweiseidige Klinge
- » Lama intera a doppio taglio

REF. 04898



### Rasiermesser mit Holzgriff

Rasoio a mano libera con manico in legno



Rasiermesser aus rostfreiem Stahl AISI 430, Farbe schwarz, hergestellt in Japan. Schwarz mit einem orangefarbenen Griff aus amerikanischem Holz. Inklusive einer eleganten Kartonschachtel.

- » Einschneidige Klinger



REF. 04983

*Rasoio in acciaio inossidabile 430, nero, prodotto in Giappone. Rivestimento nero e manico in legno americano di colore arancione. Include una elegante custodia di cartone.*

- » Lama a taglio unico



### Rasiermesser mit Kunststoffgriff

#### Rasoio a mano libera con manico in plastica

1 u.m.vta  
10 box

- » Einschneidige Klinge. Wechselbar
- » Lama a taglio unico. Intercambiabile

REF.06057



### Rasiermesser mit Metallgriff

#### Rasoio a mano libera con manico in metallo

1 u.m.vta  
10 box

- » Einschneidige Klinge. Wechselbar
- » Lama a taglio unico. Intercambiabile

REF.06058



### BARBER-LINIEN Rasiermesser

#### Rasoi BARBER LINE

1 u.m.vta  
12 box

- » Ideal zum Trimmen
- » Zweischneidige Klinge

REF.06647

- » Ideale per ritocchi
- » Lama intera a doppio taglio



### Kleines schwarzes Rasiermesser

#### Rasoio nero piccolo

1 u.m.vta  
12 box

- » Sehr kurz, ideal zum Nachbessern und für schwer zugängliche Bereiche
- » Einschneidige Klinge

REF.06435

- » Molto corto, ideale per ritocchi e zone difficili da raggiungere
- » Lama a taglio unico.



### Trimmklinge

#### Rasoio per ritocchi

1 u.m.vta  
12 box

- » Sehr kurz, ideal zum Nachbessern und für schwer zugängliche Bereiche
- » Einschneidige Klinge

REF.06421

- » Molto corto, ideale per ritocchi e zone difficili da raggiungere
- » Lama a taglio unico.



**Messer mit Schutz und Gummi BARBER LINE**  
*Rasoio BARBER LINE con protezione e gomma*

Barber Line



- » Mit Gummi
- » Drehring am Griff für mehr Komfort
- » Con gomma
- » Anello girevole sul manico per un comfort maggiore

REF.06417



REF.06419



- » Mit Gummi
- » Senza gomma

REF.06420



**Ersatzteile**  
**Ricambi**

REF. 07123



REF. 04388



REF. 04389





## RATSCHLAG CONSIGLIO

Wenn Sie mit dem Rasieren fertig sind, waschen Sie den Rasierer unter fließendem Wasser, um Haare und Schaum von der Klinge zu entfernen. Trocknen Sie es, indem Sie es mit einem Tuch oder Handtuch abreiben. Es hat viele Vorteile sich mit einem Rasiermesser zu rasieren, die geringen Kosten, da keine Ersatzklingen gekauft werden müssen, die bessere Kontrolle auf der Haut durch eine größere Klinge. Die richtige Rasur bietet oft eine glattere, gründlichere Rasur und ist ein Ritual, auf das sich viele jeden Morgen freuen.

*Quando hai finito di raderti, lava il rasoio sotto l'acqua corrente per rimuovere peli e schiuma dalla lama. Asciugalo strofinandolo con un panno o un asciugamano. Ci sono molti vantaggi nel radersi con un rasoio, i bassi costi di non acquistare lametta usa e getta, il miglior controllo nel manovrare sulla pelle un bordo di taglio più grande di quello una lametta. Radersi correttamente fornisce spesso una rasatura più liscia e più profonda e un rituale che molti aspettano con ansia ogni mattina.*

### Captain Cook Rasiermesser Rasoio a mano libera Captain Cook

Präzisions-Rasiermesser mit Captain-Cook-Holzgriff und zweiseitiger Klinge, ideal zum Rasieren. Enthält eine Schachtel zur ordnungsgemäßen Aufbewahrung

*Rasoio di precisione Captain Cook con manico in legno e lametta a doppio taglio, ideale per la rasatura. Include una custodia per una corretta conservazione*



REF.04894



REF.04932

*Rasoio a mano libera con lametta intercambiabile universale. Ergonomico grazie al design dell'impugnatura che lo rende molto comodo per la rasatura. Include una elegante custodia. Mezza lametta*



Klassischer Rasierer mit Universal-Wechselklinge. Mit Holzgriff, einschließlich einer angenehmen Ledertasche. Einschneidige Klinge

*Rasoio a mano libera con lametta intercambiabile universale. Con manico in legno, include una comoda custodia in similpelle. Mezza lametta.*



REF.04984

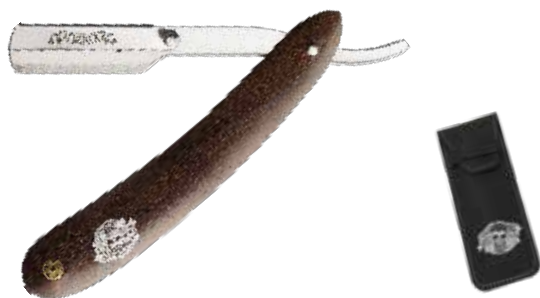

REF.04985



**Kleines schwarzes Messer**  
**Rasoio nero piccolo**1  
u.m.vta12  
box

- » Sehr kurz, ideal zum Nachbessern und für schwer zugängliche Bereiche
- » Einschneidige Klinge

- » *Molto corto, ideale per ritocchi e zone difficili da raggiungere*
- » *Lama a taglio unico.*

REF.06434

1  
u.m.vta12  
box**Trimmklinge**  
**Rasoio per ritocchi**

- » Sehr kurz, ideal zum Nachbessern und für schwer zugängliche Bereiche
- » Einschneidige Klinge

- » *Molto corto, ideale per ritocchi e zone difficili da raggiungere*
- » *Lama a taglio unico*

REF.06422

**Schwarzes Messer mit Schutz und Gummi**  
**Rasoio nero con protezione e gomma**1  
u.m.vta12  
box

- » Mit Gummi
- » Drehring am Griff für mehr Komfort

- » *Con gomma*
- » *Anello girevole sul manico per un comfort maggiore*

REF.06418



- » Ohne Gummi
- » *Senza gomma*

REF.06423

**Ersatzteile**  
**Ricambi**

REF. 07123



REF. 04388



REF. 04389



**Auswechselbare Klinge**  
**Rasoio a lametta intercambiabile**

- » Rostfreier Stahl
- » Einschneidige Klinge

- » Acciaio inossidabile
- » Lama a taglio unico.



1  
u.m.vta

12  
box

REF.02124

**Rasiermesser**  
**Rasoio per barba**

- » Einschneidige Klinge. Wechselbar
- » Rostfreier Stahl

- » Lama a taglio unico. Intercambiabile
- » Acciaio inossidabile



1  
u.m.vta

12  
box

REF.00698

**Haarschneidmesser**  
**Rasoio per capelli**

- » Einschneidige Klinge. Wechselbar .
- » Mit Kamm

- » Lama a taglio unico. Intercambiabile
- » Con Rialzi



1  
u.m.vta

12  
box

REF.00730

**Metall-Rasiermesser**  
**Rasoio in metallo per barba**

- » Einschneidige Klinge. Wechselbar
- » Lama a taglio unico. Intercambiabile



REF.04543

- » Einschneidige Klinge. Wechselbar
- » Schwarzer Gummigriff

- » Lama a taglio unico. Intercambiabile
- » Manico in gomma nera



1  
u.m.vta

12  
box

REF.04544





**Spender mit 20 Klagen**  
Dispenser 20 lame

**Professional PB-20**



REF.04391



**FEATHER ARTIST ACS-RB-Rasiermesser**  
Rasoio FEATHER ARTIST ACS-RB



**Artist ACS-RB**

REF.04390

**FEATHER ARTIST CLUB SS SCOTCH WOOD -Rasiermesser**  
Rasoio FEATHER ARTIST CLUB SS SCOTCH WOOD



**Artist ACS-RSW**

REF.04902

**FEATHER DOUBLE EDGE POPULAR**  
Rasoio FEATHER DOUBLE EDGE POPULAR



REF.04392

**Schachtel mit 10 Klagen**  
**DOUBLE EDGE**  
Confezione da 10 lame  
**DOUBLE EDGE**



REF.04393

**Box mit 10 schachteln mit 100 rostfreien halbklingen für den professionellen gebrauch**  
**Confezione da 10 scatole da 100 mezza lame inox per uso professionale**



**NEW**

- » Premium rostfreies, glattes und präzises Schneiden
- » Taglio premium inossidabile, liscio e preciso



10 Kartons x 100 rasierklingen  
 10 scatole x 100 lame

REF.07164



- » Einschneidige Klinge
- » Mezza lama.



### Behälter für gebrauchte rasierklingen Contenitore lame usate



Dieser Behälter von reduzierter Größe ist ideal für die Entsorgung von gebrauchten Rasierklingen durch Friseure.

- » Farbe: schwarz
- » Maße: Unterlage 7,5 x 7,5 cm, oberer Teil 9 x 9 cm / Höhe: 15 cm
- » Fassungsvermögen: etwa 1 l

*Di piccole dimensioni, questo contenitore è ideale per smaltire le lame da barba usate da parrucchieri e barbieri.*

- » Colore nero
- » Dimensioni: base 7,5 x 7,5 cm parte superiore 9 x 9 cm / altezza: 15 cm
- » Capacità: 1l circa



**NEW**



REF.07258



## Spender mit 20 Klingen ELIOS 20 Dispenser 20 lame ELIOS



- » 11 ELIOS-Rasierklingen
- » 11 lame con incastro ELIOS

REF. 00994

Rasierklingen-Referenz für Fachleute. Bessere Qualität der Klinge, bessere Schärfe und geschmeidige Anwendung

- » Rasierklingen aus Edelstahl
- » Traditioneller schwedischer Qualitätsstahl
- » Mit Platin behandelt für eine perfekte und sichere Rasur

*Una lametta da rasoio di riferimento per i professionisti. Migliore qualità della lama, migliore affilatura e comfort d'uso*

- » lame da rasoio inossidabili
- » Acciaio svedese tradizionale di alta qualità
- » Trattate al platino per una rasatura perfetta e sicura



- » 5 BIC-Rasierklingen
- » 5 lame con incastro BIC



REF.01351



- » 5 BOLZANO Rasierklingen
- » 5 lame con incastro BOLZANO



REF.00995



REF. 06161



- » 5 DERBY PREMIUM Rasierklingen
- » 5 lame con incastro DERBY PREMIUM



REF.02956



- » 5 Rasierklingen
- » 5 lame con incastro DERBY



REF.02308



- » 10 Supermax-Rasierklingen
- » 10 lame Supermax

### Box 100 Einweg Rasierklingen

#### Confezione da 100 lame usa e getta

Rasierklingen von hoher Schärfe und großer Glätte. Sie sind aus rostfreiem Stahl gefertigt und platinbeschichtet. Die Schachtel enthält zwanzig Kartonspender mit je fünf Klingen, die in Wachspapier eingewickelt sind.

*Lame da rasoio ad alta affilatura e di garn comfort. Realizzate in acciaio inossidabile e rivestimento in platino.*

*La confezione contiene venti dispenser di cartone con cinque lame avvolte in carta oleata ciascuno.*



REF.07100



### Box 100 Einweg Rasierklingen

#### Confezione da 100 lame usa e getta



#### Derby Premium

REF. 06160



#### Derby Professional

REF. 02955



### Schachtel mit Klinge

#### Confezione di lame



- » 10 Ersatzklingen 06192
- » 10 lame di ricambio per rasoio 06192

REF.09101



### Schachtel mit Einweg Rasiermessern mit Beschützer

#### Confezione lame usa e getta con protezione



- » 100 versiegelte Einweg Rasiermesser RAGNAR
- » 100 lame monouso sigillate RAGNAR

REF. 07439



- » Schachtel mit 100 Einweg Rasiermessern von Pollié
- » Confezione da 100 lame usa e getta Pollié



REF. 02479



- » Schachtel mit 100 Einweg Rasiermessern
- » Confezione da 100 lame usa e getta



REF. 01951



### Schachtel Einweg-Rasiermesser Eurostil

#### Confezione di lame usa e getta Eurostil

- » 100 Rasiermesser (3 Farben)
- » Ergonomisches Design



REF. 03882

- » 100 lame assortite (3 colori)
- » Design ergonomico



### Spender für Rasiermesser 03882

#### Dispenser per lame 03882

- » Leer
- » Vuoto



REF.04523



### Pen razor

#### Pen Razor

Ideal für Grafiken im Haar  
Ideale per disegnare sui capelli

- » Pen razor + 20 Klingen
- » Rasoio a penna + 20 lamette



REF.06154

- » Spender für 20 Klingen Pen razor
- » Dispenser 20 lame per rasoio a penna

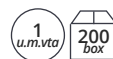

REF.06155



### Rasierschaum BIC Sensitive

#### Schiuma da barba BIC Sensitive

Speziell für empfindliche Haut erstellter Rasierschaum Seine Formel mit Aloe Vera ist für ihre beruhigende Wirkung bekannt und hilft, die durch die Rasur verursachten Reizungen zu lindern.

*Schiuma appositamente formulata per pelli sensibili. La sua formula con aloe vera è nota per i suoi effetti calmanti e aiuta ad alleviare l'irritazione causata dalla rasatura.*



250 ml

REF.03286



03

# Scheren

FORBICI

*Professionelle Schneide- und  
Modellierscheren*

*Forbici per tagliare e sfoltire*



Industrias Oriol präsentiert seine Scheren Produktreihe von hoher Qualität. Entworfen, um die Arbeit des Profis dank seiner Präzisionsschneide zu vereinfachen. Widerstandsfähig gegen hohe Abnutzung und mit einer handgefertigten Oberfläche für maximale Qualität und Präzision.

### MATERIALEIGENSCHAFTEN

- » VG-10 Edelstahl der höchsten Qualität, dieser Stahl ist ein ausgezeichneter japanischer Stahl mit hohem Kohlenstoffgehalt. Dieser Stahl bietet uns eine größere Korrosionsbeständigkeit und eine größere Fähigkeit, die Schneidkante zu halten. Seine Zusammensetzung ist wie folgt: Kohlenstoff: 1,05% - 1,5%, Mangan: 0,5%, Chrom: 14,5% - 15,5%, Vanadium: 0,1 - 0,3%, Molybdän: 0,9% - 1,2% und Kobalt: 1,5%. Aus dieser Mischung entsteht der Stahl VG-10, dessen Eigenschaften ungewöhnlich sind, was zu einer hohen Verschleißfestigkeit und damit zu einer großen Haltbarkeit führt. Sie hat eine Härte von bis zu 62 HRC.
- » Martensitischer rostfreier Stahl 440C: C: 1,05% Mn: 0,45% Si: 0,40% Cr: 17,50% Mo: 0,70% S: <0,030%. Diese Stahlsorte hat einen hohen Chrom- und Kohlenstoffgehalt, die für eine hohe Verschleiß- und Oxidationsbeständigkeit in feuchten Umgebungen ausgelegt ist. Es erreicht eine Härte von nahezu 60 HRC und bietet eine gute Stabilität der Schneidkante. Härte: 59-61 HRC.

### GRÖSSE DER SCHEREN

Die Größe der Schere wird in der Regel in Zoll gemessen. Die kurzen sind 4,5 Zoll lang, und die längeren gehen bis zu etwa 8 Zoll. Scheren werden von der Spitze bis zum längsten Griff gemessen, wobei die abnehmbare oder permanente Fingerauflage nicht berücksichtigt wird.

Die Größe wird je nach Schnitttechnik gewählt. Kürzere Scheren eignen sich besser für Detailarbeiten, längere Scheren eignen sich besser für kraftvolle Arbeiten. Die Scheren in den Größen 5,0" (13cm), 5,5" (14cm), 6,0" (15cm) und 6,5" (16cm) werden am häufigsten von Fachleuten verwendet.

### ARTEN VON SCHEREN UND GRIFFEN

Die Typen, die wir finden können, sind:

- » Rasierklingschere: Sie hat zwei gerade Blätter, ideal für Franschnitt.
- » Schere zum Ausdünnen oder Modellieren: Sie besteht aus einer gezackten Klinge und einer scharfen Klinge, ideal zum proportionalen Ausdünnen der Haare.
- » Mikroverzahnte Schneideschere: Diese Schere hat eine mikroverzahnte Klinge auf einer oder beiden Klingen, ideal, um ein Verrutschen der Haare beim Schneiden zu verhindern.
- » Ausdünnungsschere: Die beiden Blätter sind gezahnt oder gekämmt, ideal zum Ausdünnen von Haar und zur Volumenreduzierung oder Markierung von Schichten ohne Längenverlust.

Industrias Oriol S.L. presenta la sua linea di forbici di alta qualità. Progettate per favorire il lavoro del professionista grazie alla sua affilatura di precisione. Resistenti all'usura e con una finitura artigianale per ottenere la massima qualità e precisione.

### PROPRIETÀ DEI MATERIALI

- » Questo acciaio inossidabile VG-10 di altissima qualità è un eccellente acciaio giapponese ad alto tenore di carbonio. Offre una maggiore resistenza alla corrosione e una maggiore capacità di conservare l'affilatura. La sua composizione: carbonio: 1,05% - 1,5%, manganese: 0,5%, cromo: 14,5% - 15,5%, vanadio: 0,1 - 0,3%, molibdeno: 0,9% - 1,2% e cobalto: 1,5%. Questa lega dà origine all'acciaio VG-10 e le sue proprietà sono più uniche che rare, il che porta ad una elevata resistenza all'usura e quindi a una lunga durata. Ha una durezza fino a 62 HRC.
- » Acciaio inossidabile 440C: C: 1,05% Mn: 0,45% Si: 0,40% Cr: 17,50% Mo: 0,70% S: <0,030%. Questo tipo di acciaio ha un alto contenuto di cromo e carbonio ed è progettato per offrire un'elevata resistenza all'usura e all'ossidazione in ambienti umidi. Raggiunge durezza vicine a 60 HRC e offre una buona conservazione dell'affilatura. Durezza: 59-61 HRC.

### DIMENSIONI DELLE FORBICI

Le dimensioni delle forbici vengono generalmente misurate in pollici. Quelle corte sono di 4,5 pollici e le più lunghe arrivano fino a circa 8 pollici. Le forbici vengono misurate dalla punta al manico più lungo, escluso il poggiadito fisso o staccabile.

Le dimensioni vengono selezionate in base alla tecnica di taglio. Forbici più corte sono più adatte per lavori dettagliati, forbici lunghe sono più adatte per lavori di grande volume. Le forbici da 13 cm, 14 cm, 15 cm e 16 cm sono le più utilizzate dai professionisti.

### TIPI DI FORBICI E MANICI

Le tipologie che possiamo trovare sono:

- » Forbici da taglio affilatura a rasoio: Hanno entrambe le lame dritte, ideali per scalare.
- » Forbici per sfoltire: sono costituite da una lama seghettata e una lama affilata, ideali per sfoltire proporzionalmente i capelli.
- » Forbici da taglio micro-seghettate: sono quelle che hanno una micro-dentatura su una o entrambe le lame, ideali affinché capelli non scivolino durante il taglio.



4.5"

REF. 06281

Gegenüberliegender Griff, einfach oder symmetrisch

*Impugnatura opposta, basica o simmetrica*



5.5"

REF. 04629

Halbversetzter oder halbkompensierter Griff

*Impugnatura semi offset o semi compensata*



5.5"

REF. 04630

Versetzter oder kompensierter Griff

*Impugnatura offset o compensata*





**Bartschere ROOSTER**  
**Forbici da barbiere ROOSTER**



Werkstoff: japanischer 440C-Stahl  
Härte: 59-61 HRC

Materiale: acciaio giapponese 440C  
Durezza: 59-61 HRC

» Schnitt  
» Tagliare

6,5"

REF.06958



» Schnitt  
» Tagliare

7"

REF.06959



» Modellier  
» Sfaltire

6,5"

REF.06960



» Schnitt  
» Tagliare

6,5"

REF.06958/71



» Schnitt  
» Tagliare

7"

REF.06959/71



» Modellier  
» Sfaltire

6,5"

REF.06960/71



**Bartschere GLORIOUS**  
**Forbici da barbiere GLORIOUS**



Werkstoff: japanischer 440C-Stahl  
Härte: 59-61 HRC

Materiale: acciaio giapponese 440C  
Durezza: 59-61 HRC

» Schnitt  
» Tagliare

6,5"

REF.06967



» Schnitt  
» Tagliare

7"

REF.06968



» Modellier  
» Sfaltire

6,5"

REF.06969



**Bartschere LEFT DOMINANT (LINKSHÄNDER)**  
**Forbici da barbiere LEFT DOMINANT (MANCINI)**1  
u.m.v.to10  
boxWerkstoff: japanischer 440C-Stahl  
Härte: 59-61 HRCMateriale: acciaio giapponese 440C  
Durezza: 59-61 HRC» Schnitt  
» Tagliare

6,5"

REF.06979

» Schnitt  
» Tagliare

7"

REF.06980

» Modellier  
» Sfaltire

6,5"

REF.06981

» Schnitt  
» Tagliare

6,5"

REF.06979/71

» Schnitt  
» Tagliare

7"

REF.06980/71

» Modellier  
» Sfaltire

6,5"

REF.06981/71





**Bartshere BLACK PEARL**  
**Forbici da barbiere BLACK PEARL**

1 u.m.vta  
10 box

- » Werkstoff: Japanischer 440C-Stahl
- » Gehäuse: schwarzes Titan
- » Schraube: kugelgelagerte Fingereinstellung
- » Härte: 62 HRC
- » Griff: Versatz

- » Materiale: acciaio giapponese 440C
- » Corpo: titanio nero
- » Vite: regolazione del dito con cuscinetto a sfera
- » Durezza: 62 HRC
- » Impugnatura: offset



- » Schnitt
- » Tagliare



5,5"

REF.06392

- » Modellier
- » 32 schräge Zähne

- » Scolpire
- » 32 denti obliqui



6"

REF.06393



- » Werkstoff: 440C-Stahl
- » Härte: 60HRC
- » Rand: konvex

- » Materiale: acciaio 440C
- » Durezza: 60HRC
- » Bordo: convesso



- » Schnitt
- » Tagliare



7"

REF.04895

- » Modellier
- » 50 Zähne

- » Soltire
- » 50 denti



7"

REF.04896





**Bartschere BLACK PEARL**  
**Forbici da barbiere BLACK PEARL**

1 u.m.vta  
 10 box



- » Werkstoff: Japanischer 440C-Stahl
- » Gehäuse: schwarzes Titan
- » Schraube: kugelgelagerte Fingereinstellung
- » Härte: 62 HRC
- » Griff: Versatz

- » Materiale: acciaio giapponese 440C
- » Corpo: titanio nero
- » Vite: regolazione del dito con cuscinetto a sfera
- » Durezza: 62 HRC
- » Impugnatura: offset



- » Modellier
- » 32 schräge Zähne

- » Sfaltire
- » 32 denti obliqui

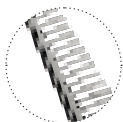

6"

REF.06394

**Bartschere BLACK RIPPER**  
**Forbici da barbiere BLACK RIPPER**

1 u.m.vta  
 10 box

Japanischer Stahl 440C. Seine Klingen wurden mit einem überlegenen Schärfegrad hergestellt, so dass sie für alle Arten von Schnitten mit nassem oder trockenem Haar geeignet sind. Diese Scheren haben ein kühnes und modernes Design, entsprechen aber durchaus dem Stil der "alten Schule". 32 gerade Zähne.

Acciaio giapponese 440C Le sue lame sono state prodotte con un grado di affilatura più elevato che le rende ideali per tutti i tipi di taglio, con capelli bagnati o asciutti. Queste forbici hanno un design audace e moderno ma non stonano con lo stile "old school". 32 denti.



- » Modellier
- » Sfaltire

6"

REF.06478



- » Modellier
- » Sfaltire

6"

REF.06479





**Bartschere SILVER DIAMOND**  
**Forbici da barbiere SILVER DIAMOND**

1 u.m.vta 10 box

8"

REF.04897

- » Werkstoff: Japanischer 440C-Stahl
- » Körper: Titan
- » Schraube: kugelgelagerte Fingereinstellung
- » Härte: 62HRC
- » Rand: konvex
- » Griff: Versatz

- » Schnitt
- » Tagliare



- » Materiale: acciaio giapponese 440C
- » Corpo: titanio
- » Vite: regolazione del dito con cuscinetto a sfera
- » Durezza: 62HRC
- » Bordo: convesso
- » Impugnatura: offset

**Bartschere BLACK QUEEN**  
**Forbici da barbiere BLACK QUEEN**

1 u.m.vta 10 box

6,5"

REF.06961

Werkstoff: Japanischer 440C-Stahl  
SchnittHärte: 59-61 HRC

- » Schnitt
- » Tagliare

Materiale: Acciaio giapponese 440C  
Durezza: 59-61 HRC



- » Drehbares Auge
- » Impugnatura rotante

**Bartschere BLACK QUEEN**  
**Forbici da barbiere BLACK QUEEN**

1 u.m.vta 10 box

6,5"

REF.06963

Werkstoff: japanischer 440C-Stahl  
Härte: 59-61 HRC

Materiale: acciaio giapponese 440C  
Durezza: 59-61 HRC

- » Schnitt
- » Tagliare

6,5"

REF.06962

- » Modellier
- » Sfaltire



**Bartschere NEPTUNO****Forbici da barbiere NEPTUNO**

- » Stahl 440
- » Messerschliff
- » Manuelle Endbearbeitung
- » Hohe Härte 59,61 HRC
- » Einstellschrauben
- » Etui

- » Acciaio 440
- » Affilatura a rasoio
- » Finitura manuale
- » Elevata durezza 59,61 HRC
- » Viti di regolazione
- » Custodia individuale



- » Schnitt
- » Tagliare



6,5"  
REF. 04625

- » Modellier
- » Sfaltire



6,5"  
REF. 04626

**Bartschere BARBER LINE****Forbici da barbiere BARBER LINE**

- » Schnitt
- » Tagliare

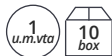

7,5"  
REF.04899

- » Werkstoff: 440C-Stahl
- » Härte: 60 HRC
- » Rand: konvex

- » Materiale: acciaio 440C
- » Durezza: 60 HRC
- » Bordo: convesso



- » Schnitt
- » Tagliare



4,5"

REF.06281

- » Ideal zum Nachbessern des Bartes
- » Ideale per ritoccare la barba

**PIRATA Schere****Forbici PIRATA**

- » Schnitt
- » Tagliare

5,5"

REF. 04630



**WAVES-Friseurschere Stahl**  
Forbici da taglio in acciaio WAVES

1 u.m.vta  
12 box

» Schnitt  
» Tagliare

6"  
REF.04316

» Modellier  
» Sfaltire

5,75"  
REF.04317



**Professionelle Friseurschere ERGO**  
Forbici professionali ERGO

1 u.m.vta  
12 box

» Schnitt  
» Tagliare

6"  
REF.04314

» Modellier  
» Sfaltire

6"  
REF.04315



**Professionelle Friseurschere RUBI**  
Forbici professionali RUBI

1 u.m.vta  
12 box

» Schnitt  
» Tagliare

5"  
REF.04319

» Modellier  
» 25 Zähne  
» Sfaltire  
» 25 denti

5,5"  
REF.04401



**Friseurschere mit Messerschliff in schwarz und goldenem Griff**  
**Forbici affilatura a rasoio, nere con manico dorato**

1 u.m.vta  
12 box

» Schnitt  
» Tagliare

5,5"

REF.04499



» Modellier  
» Sfaltire

5,5"

REF.04500



**Friseurschere mit Messerschliff in schwarz matt**  
**Forbici affilatura a rasoio, nero satinato**

1 u.m.vta  
12 box

» Schnitt  
» Tagliare

5,5"

REF.04501



» Modellier  
» Sfaltire

5,5"

REF.04502



Fotografie: Pugilato / Fotografia: Pugilato



## Azubi-Scheren Forbici RAGNAR

1 u.m.vta  
12 box

» Schnitt  
» Tagliare

6"

REF.04358

» Schnitt  
» Tagliare

6,5"

REF.04359

» Schnitt  
» Tagliare

7"

REF.04360



» ModellierAusdünnen  
» Sfoltire

6,5"

REF.04361



## ModellierAusdünnen Kit taglio studente

1 u.m.vta  
50 box

» 1 Frisierschere  
» 1 Modellierschere  
» 1 Rasiermesser Metall

» 1 Forbice da taglio  
» 1 Forbice per scolpire  
» 1 Rasoio in metallo

6"

REF.04901



## Spezielle professionelle Schere LINKSHÄNDER

### Forbici professionali speciali per MANCINI

» Schnitt  
» Tagliare

1  
u.m.vta

30  
box

5,5"

REF.02213

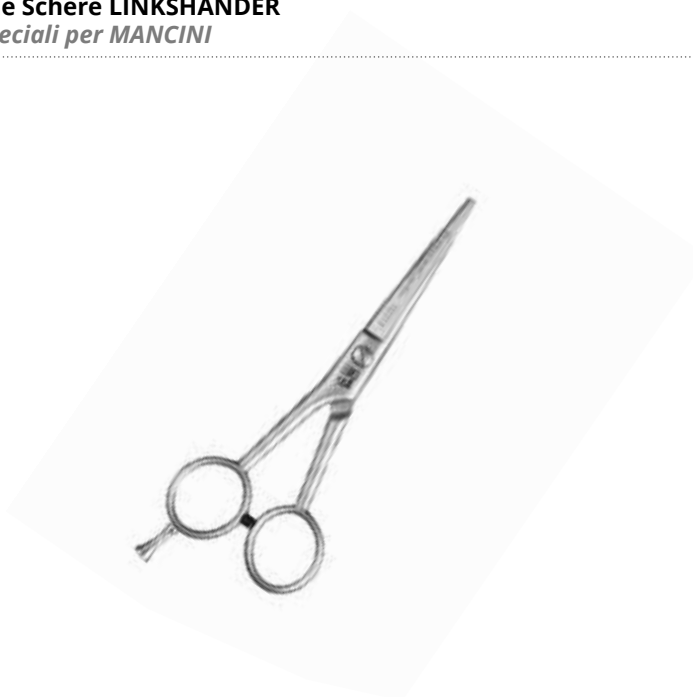

## LINKSHÄNDER Messerschliff Schere MATT

### Forbici a rasoio per MANCINI MATT

» Schnitt  
» Tagliare

5,5"

REF.04503

» Modellier  
» Sfaltire

5,5"

REF.04504



04

# Bürsten und pinsel

SPAZZOLE  
E PENNELLI

*Bartbürsten und  
Rasierpinsel, Talkumpulver...*

*spazzole, pennelli e talco...*



**Bartbürste aus NYLON mit Talkumpuderreservoir**  
**Pennello da collo, setole in nylon con spargitalco**



» Schwarze Borsten  
 » Setole nere

REF.01463



REF.01463/50



REF. 00788



REF. 00788/68



**Bartbürste**  
**Pennello da collo**

» Holzgriff  
 » Manico in legno



REF. 00336

» Nylon  
 » Nylon



REF. 03403

» Nylon  
 » Nylon



REF. 01412



**Rasierpinsel**  
**Pennelli da barba**



» Naturborsten aus Schweine- und Ponyhaaren

REF. 04371

» Natürliche Ponyhaar-Borsten

REF. 04372

» Naturborsten aus Schweine- und Ponyhaaren

REF. 04373

» Setole di pelo naturale di maiale e pony

» Setole di pelo naturale di pony

» Setole di pelo naturale di maiale e pony

Ø 21



Ø 24



Ø 24



**Vintage-Rasierpinsel**  
**Pennelli da barba vintage**



» Die Borsten der Bürste sind natürliches Schweinehaar (mit Chlor gekocht, um die Farbe aufzuhellen)  
» Borsten etwa 5 cm lang  
» Holz- und Metallgriff

» Le setole del pennello sono in pelo naturale di maiale (bollite con cloro per schiarire il colore)

» Setole da 5 cm circa di lunghezza  
» Manico in legno e metallo

L

REF.00644



S

REF.00645



**Rasier Seifenschale**  
**Portasapone da barba**



REF.04255



### Flasche Talkumpulver Spartal 280gr Talco 280 gr



280 gr

REF. 01293



### Barber Line Talkum Talco Barber Line



200 gr

REF. 06428

- » Absorbiert Feuchtigkeit
- » Hält die Haut kühl und trocken
- » Beruhigt gereizte Haut
- » Macht die Haut weich
- » Allergen- & Parabenfrei, dermatologisch getestet
- » GEBRAUCHSANWEISUNG: auf die Hände oder den Pinsel streuen und so oft wie nötig auftragen

- » *Assorbe l'umidità*
- » *Mantiene la pelle fresca e asciutta*
- » *Lenisce la pelle irritata*
- » *Ammorbidisce*
- » *Privo di allergeni e paraben, dermatologicamente testato*



### Dose mit duftendem Talkumpulver Latta di talco profumato



300 gr

REF. 06437



- » Absorbiert Feuchtigkeit
- » Hält die Haut kühl und trocken
- » Beruhigt gereizte Haut und macht sie weich
- » Keine Parabene oder Allergene
- » Innovative und umweltfreundliche Verpackung
- » Mit einem männlichen Aroma
- » Innovative Verpackung

- » *Assorbe l'umidità*
- » *Mantiene la pelle fresca e asciutta*
- » *Lenisce la pelle irritata e ammorbidisce*
- » *Senza paraben o allergeni*
- » *Packaging innovativo ed ecologico*
- » *Con profumo maschile*



### Spezialkamm Bart

*Pettine speciale per barba*



REF.06176



### Rasierset für Männer

*kit rasatura*



Klassisches Rasierset für Männer, die auf das Vergnügen einer altmodischen Rasur nicht verzichten wollen. Es enthält einen Rasierer für eine präzise Rasur, einen ergonomischen Pinsel für den Komfort und eine Schale, ein unverzichtbares Werkzeug für jeden Barbier. Rasieren Sie sich auf die altmodische Art und Weise und erhalten Sie in nur wenigen Minuten eine perfekte und präzise Rasur.

*Kit rasatura classico per chi ama la raffinatezza e non vuole rinunciare al piacere della rasatura vecchio stile. Contiene un rasoio per una rasatura precisa, un pennello ergonomico che fornirà comfort e una bacinella, uno strumento indispensabile per qualsiasi barbiere. Raditi alla vecchia maniera e ottieni una rasatura perfetta e precisa in pochi minuti.*



REF.06177

### Barber Line Nackenwedel aus Holz Spazzola per il collo Barber Line in legno

Barber Line Pinsel. Polierte Nylon-Borsten. Große Geschmeidigkeit und Schleppkraft. Ideal zum Entfernen von abgeschnittenen Haaren an Hals und Nacken.

*Spazzola da barbiere Barber Line Setole smussate in nylon Grande morbidezza e forza di spazzolatura.*



REF. 06070



### TRITON-Nackenwedel Spazzola TRITON

Das Design dieses Pinsels ist so gestaltet, dass nach jedem Schnitt die restlichen Haare am Nacken gefegt werden. Der TRITON-Pinsel besteht zu 100% aus Naturholz, während seine Borsten zu 100% synthetisch sind. Seine weichen Borsten nehmen die Haarreste ohne zu kratzen mit.

*La spazzola TRITON è realizzata in legno naturale al 100% mentre le sue setole sono sintetiche al 100%. Le sue setole morbide trascinano i resti dei capelli senza graffiare.*



REF. 06076



11,5 cm



### Nackenwedel mit polierten Borsten Spazzola da barbiere con setole smussate

Barber Line Bürste aus Holz. Mit Nylonborsten, die für große Geschmeidigkeit und Schleppkraft sorgen. Ideal zum Entfernen von abgeschnittenen Haaren im Nacken und Nackenbereich.

*Spazzola da barbiere Barber Line in legno Con setole in nylon, che forniscono grande morbidezza e forza di spazzolatura.*



REF.06116





### Bartbürste POSEIDON

#### Spazzola da barba POSEIDON



Sein abgerundetes Design passt perfekt in die Handfläche, so dass Sie den Bart bequem kämmen können. Die POSEIDON-Bürste besteht zu 100% aus Naturholz. Seine Borsten, 50 % natürlich und 50 % Nylon, sorgen für jenen Hauch von Weichheit, den der natürliche Borsten nicht bietet.

*Il suo design arrotondato si adatta perfettamente al palmo della mano permettendo di pettinare comodamente la barba. La spazzola POSEIDÓN è realizzata al 100% in legno naturale. Le sue setole, 50% naturali e 50% in nylon, danno quel tocco di morbidezza che la setola naturale non offre.*



10 cm

REF. 06078

### TALASA- Bartbürste

#### Spazzola da barba TALASA



Diese kleine Bürste ohne Stiel und abgerundeter Form ist perfekt für diese kurzen Bärte. Dank seiner geringen Größe können wir auch schwer zu durchkämmende Bereiche wie den Schnurrbartbereich erreichen. Die TALASA-Bürste besteht zu 100% aus Naturholz. Seine Borsten, 50 % natürlich und 50 % Nylon, sorgen für jenen Hauch von Weichheit, den der natürliche Borsten nicht bietet.

*Spazzola piccola senza manico e dalla forma arrotondata è perfetta per le barbe corte. Le sue dimensioni ridotte ci permettono di raggiungere quelle zone difficili da pettinare come la zona dei baffi. La spazzola TALASA è realizzata al 100% in legno naturale. Le sue setole, 50% naturali e 50% in nylon, danno quel tocco di morbidezza che la setola naturale non offre.*



8 cm

REF. 06073

### OCEAN Bartbürste

#### Spazzola da barba OCEANO



Das Design dieser Bürste ist für die Haar- und Bartpflege konzipiert. Die OCEANO-Bürste besteht zu 100% aus Naturholz. Seine 50 % natürlichen Borsten und 50 % Nylon sorgen für jenen Hauch von Weichheit, den der natürliche Borsten nicht bietet.

*Il design di questa spazzola è concepito per la cura della barba. La spazzola OCEANO è realizzata al 100% in legno naturale. Le sue setole, 50% naturali e 50% in nylon, danno quel tocco di morbidezza che la setola naturale non offre.*



20 cm

REF. 06075

### APOLO Bartbürste

#### Spazzola da barba APOLO



Das Design dieser Bürste ist für jene dichten Bärte gedacht, die schwer zu kämmen sind. Seine große Größe erlaubt es, breite und dichte Bereiche unseres Bartes zu bürsten. Die APOLO-Bürste besteht zu 100% aus Naturholz. Seine 50 % natürlichen Borsten und 50 % Nylon sorgen für jenen Hauch von Weichheit, den der natürliche Borsten nicht bietet.

*Il design di questa spazzola è pensato per quelle barbe folte e difficili da pettinare. Le sue ampie dimensioni consentono di spazzolare aree ampie e folte della nostra barba. La spazzola APOLO è realizzata al 100% in legno naturale. Le sue setole, 50% naturali e 50% in nylon, danno quel tocco di morbidezza che la setola naturale non offre.*

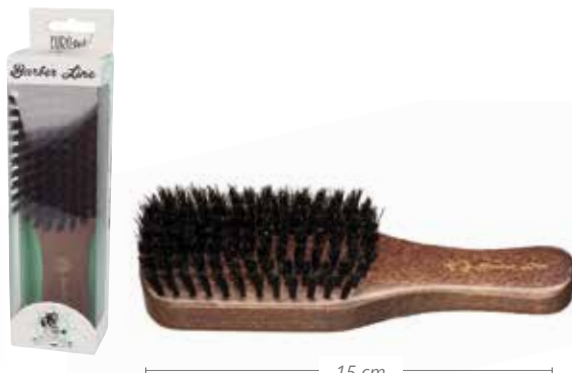

15 cm

REF. 06077

### Barber Line Rundholzbürste

#### Spazzola circolare Barber Line in legno

1  
u.m.vta

36  
box



Holzbürste mit Wildschweinborsten, ideal für Toupets und voluminöse Frisuren.  
Spazzola in legno con setole di cinghiale ideale per ciuffi e acconciature voluminose.

REF.06671



### NEREO Bartbürste aus Holz

#### Spazzola da barbieri in legno NEREO

1  
u.m.vta

12  
box

Diese kleine Bürste mit Holzgriff eignet sich perfekt für kurze Bärte. Sein Griff ermöglicht es Ihnen, kleine Bereiche wie den Schnurrbart zu kämmen. Der Pinsel NEREO besteht aus 100% Naturholz. Seine 50% natürlichen Borsten und 50% Nylon sorgen für jenen Hauch von Weichheit, den der natürliche Borsten nicht bietet.

*Questa piccola spazzola con manico in legno è perfetta per le barbe corte. Il suo manico permette di pettinare piccole zone come i baffi. La spazzola NEREO è realizzata al 100% in legno naturale. Le sue setole, 50% naturali e 50% in nylon, danno quel tocco di morbidezza che la setola naturale non offre.*

### Kleiderbürste GORGONAS

#### Spazzola per abiti GORGONAS

1  
u.m.vta

12  
box

Diese Bürste wurde entwickelt, um die Haarreste zu entfernen, die nach dem Schnitt an der Kleidung haften. Die GORGONAS-Bürste besteht zu 100% aus Naturholz und ihre Borsten bestehen zu 100% aus Nylon. Seine robusten Borsten schleppen Haare und Schmutz weg und hinterlassen saubere Kleidung. Sein ergonomischer Griff ermöglicht einen bequemen Umgang mit der Bürste während der Arbeit.

*Questa spazzola è stata progettata per rimuovere i residui di capelli intrappolati negli indumenti dopo il taglio. La spazzola GORGONAS è realizzata al 100% in legno naturale e le sue setole sono al 100% in nylon. Le sue setole robuste spazzolano via capelli e sporco, lasciando i vestiti puliti. La sua impugnatura ergonomica consente una comoda presa della spazzola durante la spazzolatura.*



REF. 06072



11,5 cm



REF. 06074



27 cm

### Fade Bürste: für Stufenbart

#### Spazzola Fade: per sfumature da barbieri

1  
u.m.vta

24  
box

Kunststoffbürste mit weichen Nylon Borsten, ideal für "Fade"-Schnitte  
Spazzola in plastica con setole morbide in nylon ideale per tagli "fade"

REF. 04976



15 cm



**Barbier-Nackenwedel**  
*Spazzola per il collo*



- » Kunststoffgriff
- » Bündeln: Nylon

- » Manico in plastica
- » Setole in nylon



REF. 00501

- » Holzgriff
- » Bündeln: Nylon

- » Manico in legno
- » Setole in nylon



REF. 00595



**Große Bartbürste**  
*Spazzola grande*

- » Kunststoffgriff
- » Bündeln: Nylon

- » Manico in plastica
- » Setole in nylon



REF. 00306

**Wildschwein reine Flache Bürste**  
*Spazzola piatta puro cinghiale*

- » Natürliches Wildschweinhaar
- » Setole naturali di cinghiale



REF. 00599



**Balgbürste mit Holzgriff und Wildschweinborsten**  
*Spazzola curva scheletro*

- » Holzgriff
- » Naturborsten vom Wildschwein

- » Manico in legno
- » Setole naturali di cinghiale



REF. 00352



**Gebogene Skelettbürste**  
*Spazzole curve a scheletro*

- » Kunststoffzinken mit Kugel
- » Setole in plastica con punte arrotondate



REF. 02195/50



**Antistatische Skelett-Bürsten**  
**Spazzole a scheletro antistatica**

- » Nylonzinken mit Kugel
- » Setole in nylon + punte arrotondate

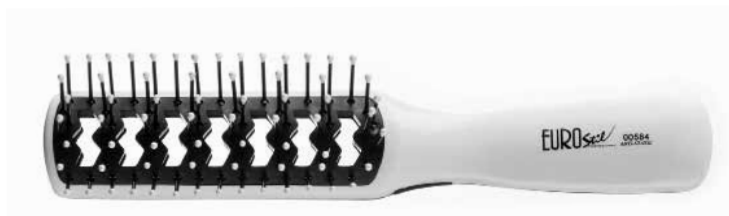

REF. 00584

**Doppelte Skelettbürsten**  
**Spazzole doppie a scheletro**

REF. 02182

REF. 02182/50

**Fade Bürste: für Stufenbart**  
**Spazzola Fade: per sfumature da barbieri**

Kunststoffbürste mit weichen Nylonbündeln, ideal für "Fade"-Schnitte  
Spazzola in plastica con setole morbide in nylon ideale per tagli "fade"

REF. 04977



05

# Kämme

PETTINI

*Barber Line Kämme, Captain  
Cook Kämme, Eurostil Kämme,  
Silkcomb Kämme...*

*Pettini Barber Line, Pettini  
Captain Cook, Pettini Eurostil,  
Pettini Silkcomb...*



**Barbierkamm**  
**Pettine da barbiere**

REF.07355

- » Schwarz
- » Nero



18 cm

- » Elfenbein
- » Avorio

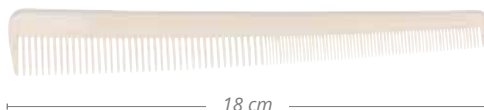

18 cm

REF.07355/82

- » Klassisch
- » Classico



18 cm



REF.07355/98

**Barbierkamm Schneiden**  
**Pettine da barbiere taglio**

REF.07356

- » Schwarz
- » Nero



17,5 cm

REF.07356/82

- » Elfenbein
- » Avorio



17,5 cm

- » Klassisch
- » Classico

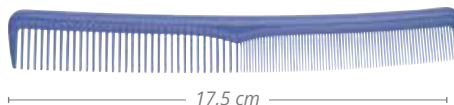

17,5 cm



REF.07356/98

- » Schwarz
- » Nero



19,5 cm

REF.07357

- » Elfenbein
- » Avorio



19,5 cm

REF.07357/82

- » Klassisch
- » Classico

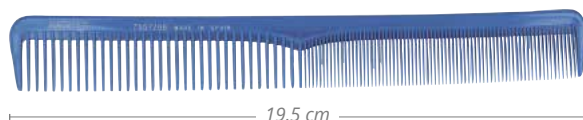

19,5 cm



REF.07357/98

**Barbierkamm Schneidekamm**  
**Pettine da barbiere tartaruga**



REF.07358

MOD. 04616

» Schwarz  
» Nero

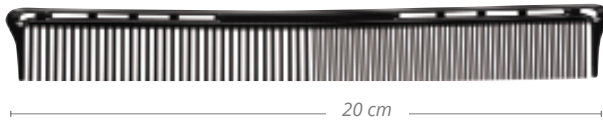

REF.07358/82

MOD. 04616/82

» Elfenbein  
» Avorio



REF.07358/98

MOD. 04616/98

» Klassisch  
» Classico



REF.07359

MOD. 00113

» Nylon - Negro  
» Nylon - Black



REF.07360

MOD. 00424

» Schwarz  
» Nero

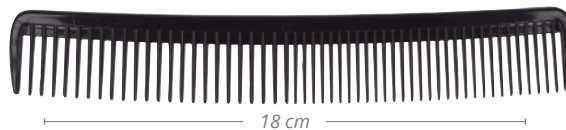

REF.07361

MOD. 00454

» Richtig - Schwarz  
» Giusto - Nero

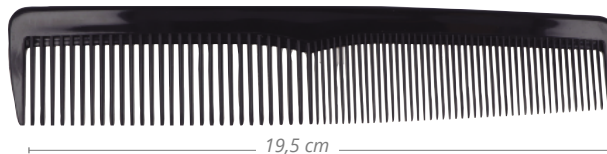

REF.07362

MOD. 00455

» Dochte - Schwarz  
» Stoppini - Nero

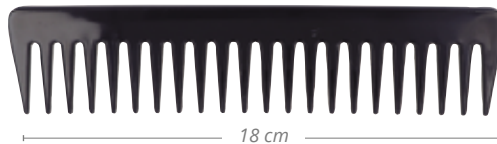

**Carbon-Kamm RAGNAR**  
**Pettini in carbonio RAGNAR**



REF.07367

MOD. 02216

» Schneidekamm  
» Pettine da taglio

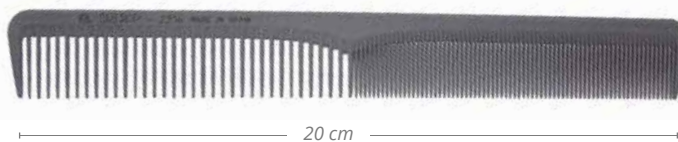

REF.07368

MOD. 02215

» Speziell  
» Speciale



**Barbierkamm Schneiden spezial**  
**Pettine da barbiere taglio speciale**

- » Spezial-Schneidekamm für Maschinenschnitt
- » *Pettine taglio speciale macchina prof.*

MOD. 02183

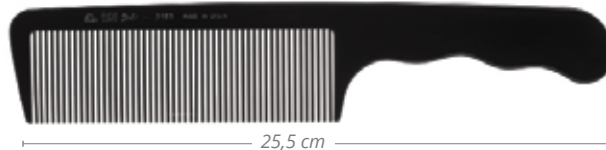

REF.07363

- » Spezial-Schneidekamm für Maschinenschnitt
- » *Pettine taglio speciale macchina prof.*

MOD. 06802



REF.07364

MOD. 06802/82



REF.07364/82

**Barbierkamm Schneiden Fingerkamm**  
**Pettine da barbiere districante afro**

- » Schwarz
- » *Nero*

MOD. 00419/50



REF.07365/50

- » Schwarz
- » *Nero*

MOD. 00409/50



REF.07366/50

MOD. 00409



REF.07366/55



**CAPTAIN COOK Kammlinie**  
**Linea pettine CAPTAIN COOK**



REF. 04981

» Kohlenstoff  
 » Carbonio



REF.07441

» Schwarz  
 » Nero

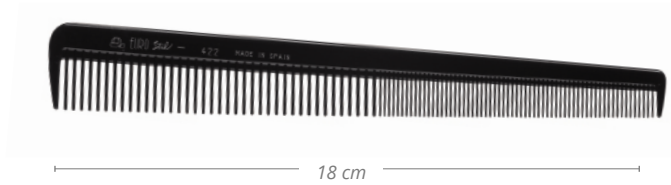

REF.07441/82

» Elfenbein  
 » Avorio



REF.07442

» Schwarz  
 » Nero

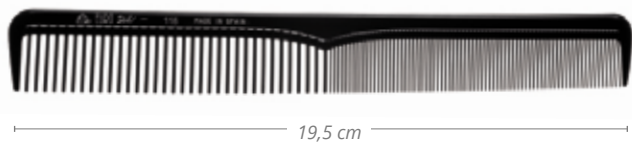

REF.07442/82

» Elfenbein  
 » Avorio



REF.07443

» Schwarz  
 » Nero



REF.07443/82

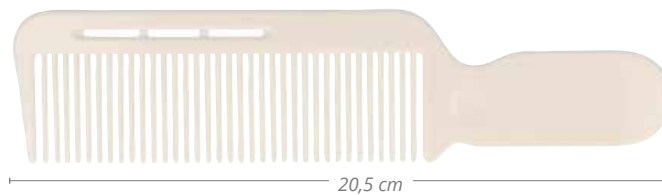

REF.07444

» Haar Dichte / Schwarz  
 » Stoppini - Nero



**SPEZIELL BART & SCHNURRBART**  
**SPECIALE BARBA E BAFFI**

**Holz-kamm Schnurrbart**  
**Pettine barba-baffi in legno**

- » Breit
- » Larghezza



- » Mit Griff
- » Con manico



REF.04548

REF.04549



9 cm



10 cm

**Bart-Schnurrbart-Kamm Muscheleffekt**  
**Pettine tartaruga barba-baffi**

- » Langer Stiel
- » Manico lungo



- » Langer Stiel
- » Manico lungo



REF.04546

REF.04547



11 cm



8 cm

- » Faltbar
- » Pieghevole



REF.04545



11,5 cm öffnen - aperto

6,5 cm geschlossen - chiuso

**Eurostil Profi-Schlägerkamm**  
*Pettine da taglio professionale Eurostil*



» Spezielle Zahnung  
» Punta speciale



REF. 00115

» Spezielle Zahnung  
» Punta speciale



REF. 00442

» Spezielle Zahnung  
» Punta speciale



REF. 00441

» Spezial verstärkt  
» Speciale rinforzato



REF. 00424

» Groß  
» Grande

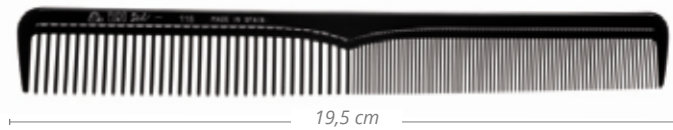

REF. 00116

» Superlang  
» Super lungo



REF. 01470

**Spezieller Friseurkamm**  
*Pettine speciale per parrucchieri*



REF. 00422



REF. 00422/58

## Carbonbürsten

### Pettini in carbonio



REF. 02186

- » Schneidekamm
- » *Pettine da taglio*



REF. 02216

- » Schneidekamm
- » *Pettine da taglio*



REF. 02214

- » Spezielle Zahnung
- » *Punta speciale*



REF. 02215

- » Speziell für Friseure
- » *Pettine speciale da parrucchiere*



REF. 02187

- » Spezielle Zahnung
- » *Punta speciale*



REF. 02188

- » Mod. GERADE
- » Mod. DRITTO



**SILKOMB Profi-Kamm**  
Pettini professionale SILKOMB

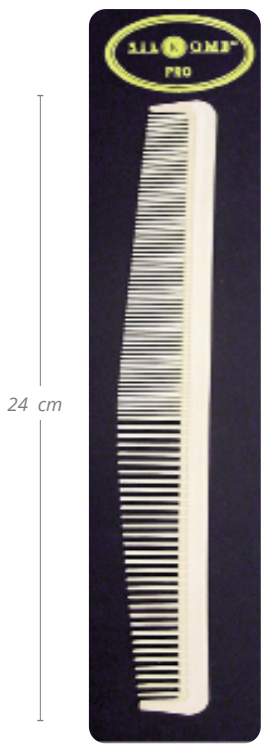

PRO-10  
REF. 01520

24 cm

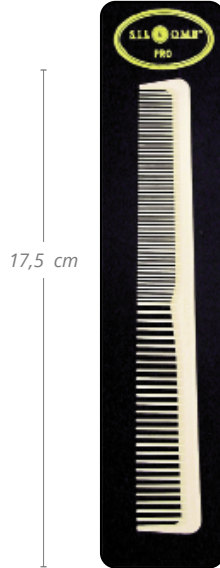

PRO-11  
REF. 01521

17,5 cm

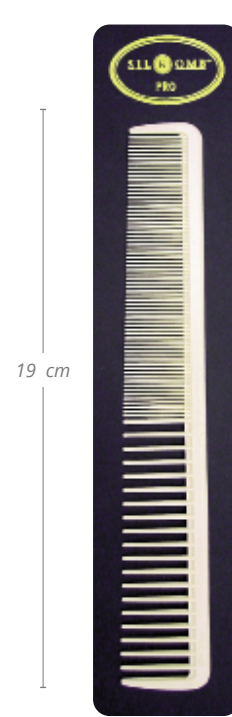

PRO-20  
REF. 01522

19 cm

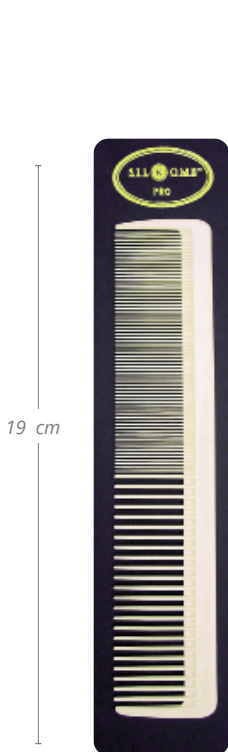

PRO-30  
REF. 01523

19 cm

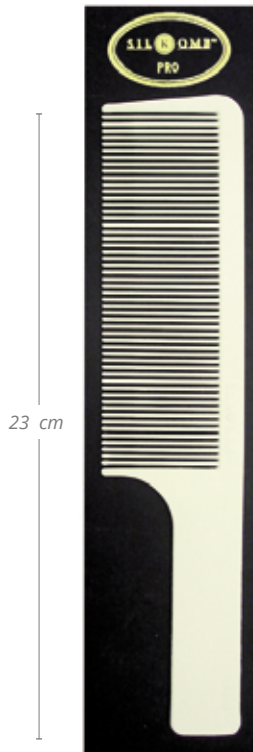

PRO-40  
REF. 01524

23 cm



PRO-50  
REF. 01525

22,5 cm

### Kamm mit Wasserwaage Pettine con livelle



REF. 04349

- » Kamm mit Wasserwaage
- » Es erlaubt einen perfekten Schnitt oder Maßstab in einer geraden Linie dank seiner 3 Wasserwagen

- » *Pettine con livelle*
- » *Consente di tagliare o scalare in perfetta linea retta grazie alle 3 livelle*



22 cm

### Kamm-Reinigungsbürste Spazzola per la pulizia del pettine



REF. 00600



11,5 cm



natural colours:  
**nco**  
organic

# Kosmetik

COSMETICI

*Haarkosmetik, Bartkosmetik,  
Fixierkosmetik...*

*Cosmetici per capelli, cosmetici per  
barba, cosmetici fissanti...*





## Shampoo für empfindliche Kopfhaut Shampoo per cuoio capelluto sensibile



250 ml PH 5.5

REF. 04963



750 ml PH 5.5

REF. 04964



NEW



500 ml PH 5.5

REF. 07374

NEW

1L PH 5.5

REF. 07375

### Regulierung Kopfhaut

Mit milden Tensiden mit hohem Benetzungsvermögen, so dass die Oberflächenspannung des Wassers herabgesetzt wird. Aufgrund seiner aktiven Inhaltsstoffe besitzt es haarkonditionierende Eigenschaften, um das Haar leichter kämmbar zu machen, liefert Feuchtigkeit, um das Gefühl von Trockenheit und Brüchigkeit zu überwinden, kontrolliert die Produktion toter Zellen auf der Kopfhaut und besitzt antibakterielle und antimykotische Wirkung. Ideal für empfindliche Haare und Kopfhaut.

### Regolatore del cuoio capelluto

Grazie ai suoi principi attivi possiede proprietà che facilitano lo styling, fornisce idratazione per superare la sensazione di secchezza e fragilità, controlla la produzione di cellule morte sul cuoio capelluto ed esercita una attività antibatterica e antimicotica. Ideale per capelli e cuoio capelluto sensibili.

## Silber-Shampoo für graues Haar Shampoo silver per capelli grigi

250 ml PH 5.5

REF. 04965



NEW



500 ml PH 5.5

REF. 07376

NEW

1L PH 5.5

REF. 07377

### Für graues Haar

Mit milden Tensiden mit hohem Benetzungsvermögen, so dass die Oberflächenspannung des Wassers herabgesetzt wird. Aufgrund seiner aktiven Inhaltsstoffe pflegt es das Haar, um es leichter kämmbar zu machen, und mit Pigmenten pflanzlichen Ursprungs, die Farbveränderungen bei grauem Haar verhindern und den Glanz wiederherstellen. Speziell für graues Haar, vermeidet und verdeckt den gelblichen Ton.

### Per capelli grigi

Grazie ai suoi principi attivi ammorbidisce i capelli per facilitarne lo styling e grazie ai pigmenti di origine vegetale che impediscono il cambiamento di colore nei capelli grigi ravviva la loro lucentezza. Speciale per capelli grigi, in quanto evita e copre i toni giallastri.



## Erfrischendes Shampoo

### Shampoo rinfrescante



250 ml PH 5.5

REF. 04869



NEW

500 ml PH 5.5

REF. 07370

NEW

1L PH 5.5

REF. 07371

Besonders geeignet zur Vorbeugung und Bekämpfung von Haarausfall, zur Stimulierung der Kopfhaut und für neue Vitalität. Es reduziert den Talg und gibt dem Haar seinen natürlichen Glanz zurück.

*Particolarmente indicato per prevenire e combattere la caduta dei capelli, stimolando il cuoio capelluto e donando rinnovata vitalità. Riduce il sebo, restituendo ai capelli la loro naturale lucentezza.*

## Balsam

### Crema emolliente



250 ml PH 5.5

REF. 04870



NEW

500 ml PH 5.5

REF. 07372

NEW

1L PH 5.5

REF. 07373

Ergänzung zum Shampoo. Es enthält erfrischende und stimulierende Eigenschaften der Kopfhaut und gibt ihr ihre natürliche Feuchtigkeit und ihren Glanz zurück.

*Complemento per shampoo. Combina proprietà rinfrescanti e stimolanti per il cuoio capelluto, ripristinandone l'idratazione e la lucentezza naturale.*



**Modellierpomade zur Fixierung, sanft**  
**Cera modellante per una tenuta delicata**



1 u.m.vta 6 box

200 ml

REF. 04867

1 u.m.vta 6 box

100 ml

REF.06232

1 u.m.vta 16 box

50 ml

REF.06233



Ideal für anspruchsvolle Stile, die gut aussehen wollen. Bietet Glanz und einen weichen, flexiblen Halt ohne Rückstände zu hinterlassen. Auf Wasserbasis, so dass es dem Haar Weichheit und Hydratation verleiht.

Ideale per stili esigenti che vogliono avere un look perfetto. Fornisce lucentezza e una tenuta morbida e flessibile senza lasciare residui. A base d'acqua, dona morbidezza e idratazione ai capelli.

**Modellierpomade zur Fixierung, mittel**  
**Cera modellante per una tenuta media**



1 u.m.vta 6 box

200 ml

REF. 06229

1 u.m.vta 6 box

100 ml

REF.06230

1 u.m.vta 16 box

50 ml

REF.06231



Leicht aufzutragendes Cremewachs zur Pflege und Definition der gewünschten Frisur. Mit natürlichen Wachsen und Sheabutter, die das Haar schützen und pflegen. Natürliches, mattes Finish für jede Art von Frisur.

Cera cremosa di facile applicazione per mantenere e definire l'acconciatura desiderata. Con cere naturali e burro di karité che proteggono e si prendono cura dei capelli. Finitura opaca naturale per qualsiasi tipo di acconciatura.

### Modellierpomade zur Fixierung, stark

*Cera modellante per una tenuta forte*

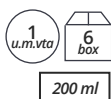

REF. 04866

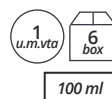

REF.06236

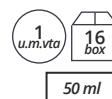

REF.06237



Pomade Verleiht Glanz und starken Halt, lässt das Haar jedoch flexibel und leicht rückstandsfrei zu entfernen. Auf Wasserbasis, die dem Finish Weichheit und Hydratation verleiht.

*Dona lucentezza e tenuta forte ma lascia i capelli flessibili, facile da rimuovere senza lasciare residui. A base d'acqua, dona morbidezza e idratazione ai capelli.*

### MATT RUBBER Pomade

*Cera per styling Rubber Matt*



REF. 04868

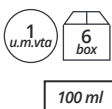

REF.06234

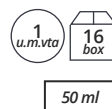

REF.06235



Mattes Pomade Stylingwachs die dem Haar Form und Volumen für eine lang anhaltende Frisur verleiht. Schnell trocknend und mattes Finish. Hinterlässt keine Rückstände. Aufgrund seiner Zusammensetzung, die reich an natürlichen Wachsen ist, verleiht es dem Haar Weichheit und Schutz.

*La cera fissante per styling Rubber Mate permette di dare forma e volume ai capelli, ottenendo un'acconciatura di lunga durata. Asciugatura rapida e finitura opaca. Non lascia residui. Grazie alla sua composizione, ricca di cere naturali, dona morbidezza e protezione ai capelli.*

**SPIDER GUM Pomade****Cera modellante a tenuta leggera Spider Gum**1  
u.m.vta6  
box

200 ml

REF. 06677

1  
u.m.vta6  
box

100 ml

REF.06678

1  
u.m.vta16  
box

50 ml

REF.06679



Faseriges Wachs zum Formen und Strukturieren von Haar. Starker Halt, langlebig und leicht zu entfernen.  
Auftragen: eine kleine Menge des Produkts zwischen den Händen reiben, mit der Reibung der Hände erwärmen, um die Fasern zu aktivieren, und auf das Haar auftragen und ihm die gewünschte Form geben.

*Cera fibrosa per modellare e strutturare i capelli. Tenuta a lunga durata e facile da rimuovere.*

*Metodo di applicazione: applicare una piccola quantità di prodotto tra le mani, riscaldare con la frizione delle mani per attivare le fibre e applicare sui capelli, dando loro la forma desiderata.*

**Fixierspray Gravity Zero****Spray Gravity Zero effetto secco**1  
u.m.vta10  
box

**Gravity Zero:** dank seiner Zusammensetzung hinterlässt es einen unsichtbaren Trockeneffekt-Film auf dem Haar mit großem Volumen und hoher Feuchthaltekraft. Ideal für jeden Haartyp, verleiht ihm Glanz. Leistungsstark auch bei hoher Luftfeuchtigkeit und Temperatur. Direkt auf das Haar sprühen und wie gewünscht stylen.

*Gravity Zero: grazie alla sua composizione, lascia sui capelli una patina invisibile dall'effetto secco e grande volume con potere idratante. Ideale per qualsiasi tipo di capello donando luminosità. Potente anche in condizioni di umidità e temperature elevate. Spruzzare direttamente sui capelli e pettinare secondo lo stile desiderato.*

125 ml

REF. 04961



### Professioneller haarlack kräftig Lacca professionale forte



Verleiht Ihrem Haar eine ausgezeichnete Fixierung und einen natürlichen Glanz und schützt es zugleich vor äußeren Einflüssen wie Wind, Feuchtigkeit usw.

Erhält die Frisur perfekt während des gesamten Tages. Long-lasting-Effekt. Einfach zu entfernen durch leichtes Bürsten. Stärkt die Haarfaser.

*Dona ai tuoi capelli un'ottima tenuta e una lucentezza naturale proteggendoli dagli agenti esterni come vento, umidità, ecc. Mantiene l'acconciatura perfetta per tutto il giorno. Effetto duraturo. Si rimuove facilmente con una leggera spazzolatura. Rafforza la fibra capillare.*



300 ml

REF.07129

NEW

### Ökologisches Haarspray Lacca ecologica



Captain Cook Haarspray ist ideal für strukturiertes Arbeiten, es respektiert das Haar dank der Wirkung des Provitamins B5. Seine mikrofeine Diffusion überlastet das Haar nicht und lässt sich beim Bürsten leicht entfernen.

*Captain Cook Hair Spray, rispetta i capelli grazie all'azione della provitamina B5. La sua diffusione micro-fine non sovraccarica i capelli.*



300 ml

REF.07113

### Locken-gel captain cook Gel riccioli captain cook



Die Creme zur Definition von Locken ist speziell dafür zusammengestellt, um auf einfache und bequeme Weise Locken und Wellen im Haar zu gestalten. Die Weizenproteine sorgen für Hydratisierung und Glanz und verhindern das Kräuseln. Formen Sie Ihren Look mit den Fingern. Für eine optimale Definition der Locke an der Luft oder mit dem Diffuser trocknen lassen.

#### Vorteile

- » Lockendefinition
- » Maximale Hydratation
- » Volumen

*Questa crema per la definizione ricci è appositamente formulata per disegnare ricci e onde nei capelli in modo facile e confortevole. Le proteine del grano forniscono idratazione e lucentezza, prevenendo l'effetto crespo. Dai forma al tuo look con le dita. Lascia asciugare all'aria o con un diffusore per una definizione ottimale dei riccioli.*

#### Benefici

- » Definizione dei ricci
- » Massima idratazione
- » Volume

250 ml

REF.07378



NEW

## Volumenpulver Gravity Powder

### Polverevolumizzante Gravity Powder



» Mit Zerstäuber  
» Con sprayer

Bestes  
preisgekröntes  
Produkt des Jahres  
Premio per il  
miglior prodotto  
dell'anno

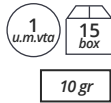

REF. 06473

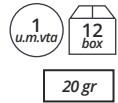

REF. 04962

**Gravity Powder:** ultraleichtes texturiertes Mattierungspulver verleiht dem Haar großes Volumen, wobei die Anwendung durch minimales Massieren der Haarwurzel einfach ist. Ideal zum Fixieren stark strukturierter Frisuren. Weicher Matteffekt. Dank seiner Wirkstoffe fettet es selbst bei anfälligem Haar nicht und hilft, überschüssigen Talg zu absorbieren. Kontrolle und Langanhaltender Halt.

*Gravity Powder: polvere opacizzante texturizzante ultraleggera. Dona grande volume ai capelli con la sua facile applicazione con un semplice massaggio dalla radice del capello. Ideale per fissare acconciature molto strutturate. Con leggero effetto opaco. Grazie ai suoi principi attivi non unge i capelli, anche su quelli inclini a diventarli, aiutando ad assorbire la seborrea in eccesso. Tenuta a lunga durata.*

## Bourbon-Shampoo 1874

### Shampoo Bourbon 1874



Speziell erstelltes Shampoo für harte Männer, die ihr Haar sauber, glänzend und widerstandsfähig halten wollen. Spezifisch für alle Haar- und Kopfhauttypen. Geeignet für den täglichen oder häufigen Gebrauch. Schützt Haar und Kopfhaut und verleiht ihnen Ausgeglichenheit und Gesundheit

*Shampoo appositamente formulato per "uomini duri" che vogliono mantenere i capelli puliti, lucenti e resistenti. Specifico per tutti i tipi di capelli e cuoio capelluto. Indicato per un uso quotidiano o frequente. Protegge i capelli e il cuoio capelluto donando equilibrio e salute.*



5 L

REF. 07096

## Packung Bart

### Kit Barba



Enthält 250 ml Bart-Shampoo  
+ 30 ml Bartöl + 50 ml Bartwachs

REF. 06668

*Include 250 ml di shampoo per barba  
+ 30 ml di olio da barba + 50 ml di cera da  
barba*

## Packung Haar

### Kit Capelli



Enthält 250 ml Erfrischungsshampoo + 20  
g Gravity Powder + 50 ml Bartwachs matt

REF. 06669

*Include 250 ml di shampoo rinfrescante + 20  
g di Gravity Powder + 50 ml di cera opaca*



Kulturbeutel Leer  
Beauty case vuoto

REF. 07079

**Rasieröl Vorbehandlung**  
*Olio pre-rasatura*

30 ml

REF. 04860

**Bart-Öl**  
*Olio da barba*

30 ml

REF. 04861

**Bartwachs**  
*Cera da barba*

50 ml

REF. 04865

Für eine angenehme Rasur. Speziell entwickeltes Produkt zur Behandlung der Haut vor der Rasur.. Enthält erfrischende Wirkstoffe, die das sichere ziehen der Klinge unterstützen.

*Per una piacevole esperienza di rasatura. Prodotto appositamente studiato per trattare la pelle prima della rasatura. Contiene attivi rinfrescanti che aiutano a far scorrere la lama in sicurezza.*

Gesunder und angenehmer Bart. Mischung aus natürlichen Ölen, die das Barthaar nähren und ihm Feuchtigkeit spenden und dazu beitragen, ihn gesund und angenehm zu halten. Nicht fettend.

*Barba sana e gestibile. Miscela di oli naturali che nutrono e idratano i peli della barba aiutando a mantenerli sani e pettinabili. Non unge.*

Meistern Sie Ihren Bart. Hohe Konzentration natürlicher Wirkstoffe wie Arganöl und Hagebuttenöl, die das Haar in der Tiefe schützen und nähren, ohne ein fettiges Gefühl zu vermitteln.

*Alta concentrazione di principi attivi naturali come olio di argan e rosa canina, che proteggono e nutrono.*

**Bart-Shampoo**  
*Shampoo da barba*

250 ml PH 5.5

REF. 04862

**Rasierschaum**  
*Schiuma da barba*

250 ml PH 5.5

REF. 04863

**Rasiercreme Nachbehandlung**  
*Crema dopobarba*

250 ml PH 5.5

REF. 04864

Tiefenreinigung. Reinigungssseife mit feuchtigkeitsspendenden und weichmachenden Eigenschaften. Erzeugt einen dichten Schaum, der Verunreinigungen weglöst.

*Pulizia profonda. Shampoo detergente con proprietà idratanti ed emollienti. Produce una schiuma densa che elimina le impurità.*

Rasieren ist einfach... Erstellt mit sanften, feuchtigkeitsspendenden Wirkstoffen zum Schutz der Haut. Speziell entwickelt, um die Poren zu öffnen, die Haut mit Feuchtigkeit zu versorgen und den Bart weicher zu machen, um die Rasur zu erleichtern.

*Radersi è facile... Formula a base di principi attivi delicati e idratanti che proteggono la pelle. Appositamente progettato per aprire i pori, idratare la pelle e ammorbidire la barba per una facile rasatura.*

Ideal für empfindliche Haut. Seine regenerierenden und beruhigenden Komponenten machen es ideal für das After-Shave und sorgen für ein angenehmes Gefühl von Frische und Feuchtigkeit.

*Ideale per pelli sensibili. Le sue componenti rigeneranti e lenitive lo rendono ideale per il dopobarba, donando una piacevole sensazione di freschezza e idratazione.*



### Aussteller Bart von Captain Cook Espositore Captain Cook

- » 6 Stück von jedem Bart Ref. (04860 bis 04865)
- » GESCHENK: Holz-Aussteller, 4 T-Shirts, 1 Mütze, 1 Tasche, 25 Kataloge E

» 6 unità di ogni REF da barba (dal 04860 al 04865)



REF.04945

### Aussteller Pomade von Captain Cook Espositore per pomate Captain Cook

- » 6 Pomaden von jedem Ref. (50 ml und 100 ml)
- » GESCHENK: Holzaussteller, 2 Poster, 25 Kataloge, 1 Tasche, 1 Mütze
- » T-Shirts, 1 Mütze, 1 Tasche, 25 Kataloge, 2 Poster

» 6 pomate di ogni REF. (50 ml e 100 ml)  
» REGALO: espositore in legno, 2 poster, 25 cataloghi, 1 borsa, 1 cappello  
» magliette, 1 cappello, 1 borsa, 25 cataloghi, 2 poster

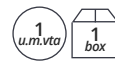

REF.06441



Aussteller Leer  
Espositore vuoto

REF.04945/01



Aussteller Leer  
Espositore vuoto

REF.06441/01

### Aussteller Groß Captain Cook für Bart und Haare Espositore grande per barba e capelli Captain Cook



- » 2 Stück je Referenz
- » GESCHENK: Holzaussteller, 8 T-Shirts, 2 Mützen, 2 Taschen, 50 Kataloge und 5 Poster

» 2 unità di ogni referenza  
» IN REGALO: espositore in legno, 8 magliette, 2 cappellini, 2 borse, 50 cataloghi e 5 poster



REF.04944

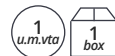

Aussteller Leer  
Espositore vuoto

REF.04944/01



THE SHAVING CO. ist ein 100%iges mexikanisches Lifestyle-Konzept, das den modernen Mann definiert, mit einer Kollektion handgefertigter Körperpflegeprodukte für Männer, die mit der besten Technologie und den hochwertigsten Inhaltsstoffen entwickelt wurden, die unsere Produkte weltweit vertreiben. Seit 2014 verbindet THE SHAVING CO. die perfekte Erfahrung unserer exklusiven Friseurläden mit der Kreativität unserer Künstler und Designer, die mit Produkten und Behandlungen für die Herrenhaarpflege immer an vorderster Front stehen.

THE SHAVING CO. ist eine einzigartige und unvermeidliche Erfahrung, die "Männlichkeit" mit "Lebensstil" in Einklang bringt, von optimaler Pflegegestaltung, basierend auf Wohlbefinden und Umweltschutz.

Unsere Sammlung von 25 Produkten wird in vier speziellen Serien präsentiert:

HAAR-SERIE STYLING MEISTERWERKE NOXIDIL R-SERIE  
BART-SERIE  
RASIER-SERIE

*The SHAVING CO. è un concetto di stile di vita 100% messicano che definisce l'uomo moderno, con una collezione di prodotti per la cura personale maschile fatti a mano, sviluppati con la migliore tecnologia e ingredienti di altissima qualità con cui vengono ideati i nostri prodotti in tutto il mondo. Dal 2014 THE SHAVING CO. unisce la perfetta esperienza dei nostri esclusivi barbieri alla creatività dei nostri artisti e designer, sempre all'avanguardia grazie ai prodotti e ai trattamenti per la cura dei capelli maschili.*

*SHAVING CO. è un'esperienza unica e imprescindibile che armonizza "mascolinità" con "stile di vita" a partire dalla creazione di una cura ottimale basata sul benessere al rispetto dell'ambiente.*

*La nostra collezione di 25 prodotti è presentata in quattro serie specializzate:*

HAIR SERIES STYLING MASTERPIECES NOXIDIL R SERIES  
BEARD SERIES  
SHAVING SERIES

**Haar-Kur**  
**Rigeneratore dei capelli**

1 u.m.vta 6 box

120 ml 240 ml

**REF.06386**
**Haarwaxse**  
**Cere per capelli**

1 u.m.vta 12 box

**Original**

113 gr

**REF.06381**

Größe: Shampoo 240 ml + Lotion 120 ml

**Vorteile:**

- » Stimuliert den Haarwuchs
- » Entfernt abgestorbene Haut und ermöglicht die Reinigung und Verbesserung geschädigter Haut
- » Stimuliert die Mikrozirkulation im Follikel
- » Reguliert die Sekretion der Talgdrüsen, befeuchtet und nährt das Haar und lässt es dicker werden
- » Erhöht das Haarvolumen
- » Verjüngt die Haarwurzeln
- » Haare, die wachsen, gehen nicht verloren
- » Enthält ECO CERT-Bestandteile
- » Sulfatfrei
- » Paraben frei

Formato: shampoo 240 ml + lozione 120 ml

**Benefici:**

- » Aiuta la crescita dei capelli
- » Elimina la pelle morta permettendo la pulizia e migliorando lo stato della pelle danneggiata
- » Stimola la microcircolazione nel follicolo
- » Regola la secrezione delle ghiandole sebacee, idratando e nutrendo i capelli, che crescono più spessi
- » Aumenta il volume dei capelli
- » Ringiovanisce le radici dei capelli
- » I capelli che crescono non cadono
- » Contiene ingredienti ECO CERT
- » Senza solfati
- » Senza parabeni

Hair Pomades ist die Pomadenserie auf Wasserbasis, die ein komplettes Sortiment für jeden spezifischen Bedarf und Geschmack bietet. Ganz gleich, ob Ihr Stil Pompadour, Entenschwanz, Fade oder einfach nur ein klassischer Schnitt ist, Hair Pomades trocknet nicht aus und lässt Ihr Haar nicht hart und brüchig werden, so dass Sie Ihr Haar den ganzen Tag über immer wieder neu stylen können. Dank ihrer fortschrittlichen Formel lässt sich Hair Pomades leicht waschen, ohne einen fettigen Rückstand zu hinterlassen, was sie heute zur beliebtesten Wahl für Haarpflege und -styling macht.

Haftung - Mittlere Haftung  
 Oberfläche: mittlerer Glanz

**Vorteile**

- » Erlaubt es Ihnen, Ihr Haar während des Tages immer wieder zu kämmen
- » Trocknet das Haar nicht aus und lässt es nicht hart werden und verfilzen
- » Mittlerer Halt / mittlerer Glanz
- » Fettfrei
- » Leicht vom Haar zu entfernen
- » Fixiert das Haar, lässt sich aber leicht mit Wasser entfernen
- » Verursacht keine Akne

*Hair cere è la serie di pomate all'acqua che offre una gamma completa per ogni specifica esigenza e gusto. Il tuo stile sia pompadour, ducktail, fade o semplicemente un taglio classico, le cere per capelli non si secceranno e non lasceranno i tuoi capelli duri e secchi, permettendoti di modellarli più e più volte per tutto il giorno. Grazie alla formula avanzata, Hair Pomades si lava facilmente senza lasciare residui grassi, essendo oggi l'opzione più ricercata per la cura e lo styling dei capelli.*

Tenuta - Tenuta media  
 Finitura: lucentezza media

**Benefici**

- » Non secca e non lascia i capelli rigidi e appiccicosi
- » Tenuta media / brillantezza media
- » Senza grassi
- » Si rimuove facilmente dai capelli
- » Fissa i capelli, ma può essere facilmente rimosso con acqua

## After shaves Splash

### Lozioni dopobarba



The Shaving Co. AFTER SHAVES ist eine Reihe von hypoallergenen, dermatologisch getesteten, alkoholfreien Aftershave-Lotionen in kleinen Packungen, die sorgfältig gemischt werden, um ein hervorragendes Ergebnis bei der Hautpflege und Rasur für Männer zu erzielen. Hochwertige, 100% natürliche Inhaltsstoffe, die mit reinen und erfrischenden Noten in jedem ihrer Aromen begeistern.

#### Vorteile:

- » Bietet hervorragende Hydratation und Ernährung für Haut und Haarfollikel ohne Chemikalien
- » Reduziert Juckreiz und trockene Haut
- » Reduziert Hautreizungen und -rötungen erheblich
- » Enthält keinen Alkohol
- » Hypoallergenes Produkt
- » Reduziert das Auftreten von Akne

*The Shaving Co. AFTER SHAVES è una serie di lozioni dopobarba ipoallergeniche, dermatologicamente testate e prive di alcool in piccoli flaconi, accuratamente miscelate per un risultato superiore nella cura della pelle e della rasatura maschile. Ingredienti premium naturali al 100% che deliziano con note pure e rinfrescanti in ciascuno dei loro aromi.*

#### Benefici:

- » Offre idratazione e nutrizione superiori alla pelle e ai follicoli piliferi senza agenti chimici
- » Riduce la sensazione di prurito e secchezza sulla pelle
- » Riduce notevolmente irritazioni e arrossamenti della pelle
- » Non contiene alcool
- » Prodotto ipoallergenico
- » Diminuisce la comparsa dell'acne

- » Sandelholz
- » Sandalo

100 ml

REF.06376



- » Zitrusfrüchte
- » Citrus

100 ml

REF.06377



- » Agrumi
- » Lavender

100 ml

REF.06378



- » 1888
- » 1888

100 ml

REF.06379



## Bart-Öle

### Olio da barba

The Shaving Co. BEARD OILS ist die erste Serie von hypoallergenen und dermatologisch geprüften Bartpflegeölen, die in kleinen Chargen hergestellt und sorgfältig gemischt werden, um hervorragende Ergebnisse bei der Pflege und Erhaltung des männlichen Bartes zu erzielen. Hochwertige 100% natürliche ätherische Öle, die mit reinen und erfrischenden Noten in jedem ihrer Aromen begeistern. BARTIERÖLE sind eines der wesentlichen Produkte, die jeder bärtige Mann besitzen kann.

#### Vorteile:

- » Bietet hervorragende Hydratation und Ernährung für Haut und Haarfollikel ohne chemische Wirkstoffe
- » Es reduziert deutlich das Gefühl von Juckreiz und Trockenheit im Bart. Vermeidet gespaltene Spitzen im Bart
- » Wirksam gegen unangenehme Gerüche vom Essen und Rauchen

*The Shaving Co. BEARD OILS è la prima serie di oli per la cura della barba ipoallergenici e dermatologicamente testati, prodotti in piccoli lotti e accuratamente miscelati per un risultato superiore nello styling e nel mantenimento della barba maschile. Oli essenziali premium naturali al 100% che deliziano con note pure e rinfrescanti in ciascuno dei loro aromi. BEARD OIL è uno dei prodotti essenziali di cui ogni uomo barbuto non può fare a meno.*

#### Benefici

- » Offre idratazione e nutrizione superiori alla pelle e ai follicoli piliferi senza agenti chimici
- » Riduce notevolmente la sensazione di prurito e secchezza sulla barba. Evita le doppie punte sulla barba
- » Contrasta efficacemente i cattivi odori derivanti dal mangiare e dal fumo

- » Lavendel
- » Lavanda



60 ml

**REF.06370**

- » 1888
- » 1888

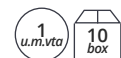

60 ml

**REF.06372**

**Bart Balsam**  
**Cera da barba**

60 ml

**Citrus**

REF. 04488

**Wilderness**

REF. 04490

**Woodland**

REF. 04489

**Bart-Öl**  
**Olio da barba**

30 ml

**Citrus**

REF. 04485

30 ml

**Woodland**

REF. 04486

30 ml

**Wilderness**

REF. 04487



Mr. Bear Family Beard Balm ist perfekt für den täglichen Gebrauch. Es befeuchtet ihn und macht ihn üppiger, weicher und schmeichelhafter. Nur mit Naturprodukten erstellt. Es ist ein hartes Wachs und muss vor der Anwendung erhitzt werden, indem es in der Tasche aufbewahrt, mit den Fingern gerieben oder mit dem Föhn kurz erhitzt wird.

Cera da barba Mr. Bear Family è perfetto per l'uso quotidiano. Idrata la barba rendendola più esuberante, morbida e gustosa al tatto. Formulato solo con prodotti naturali. È una cera dura e va riscaldata prima dell'applicazione, tenendola in tasca, sfregando con le dita o con un asciugacapelli.

Mr. Bear Family Bartöl ist nur mit natürlichen Ölen hergestellt. Macht den Bart weich und lässt ihn schmeichelhaft und nährt die Haut. Hilft, Rötungen und Reizungen zu verhindern. Befeuchtet den Bart und macht ihn weich, üppig und leicht kämmbar.

Olio da barba Mr. Bear Family realizzato solo con oli naturali. Ammorbidisce e lascia la barba gestibile nutrendo anche la pelle. Aiuta a prevenire arrossamenti e irritazioni. Idrata la barba lasciandola morbida, esuberante e facile da modellare.

**Schnurrbart-balsam**  
**Cera per baffi**

Mr. Bear Family Schnurrbartbalsam zum Verschönern und Formen des Schnurrbarts Hartwachs, das gut fixiert und den Schnurrbart in der gewünschten Form belässt. Das Wachs ist handgemacht und verwendet nur natürliche Inhaltsstoffe. Mit Karitébutter, Bienenwachs und ätherischen Ölen.

Cera per baffi Mr. Bear Family per abbellire e modellare i baffi. Cera dura che fissa bene e lascia i baffi nella forma desiderata. La cera è realizzata a mano, utilizzando solo ingredienti naturali. Con burro di karité, cera d'api e oli essenziali.

**Original**

30 ml

REF. 04491

**Citrus**

30 ml

REF. 04492

**Wilderness**

30 ml

REF. 04493

**Woodland**

30 ml

REF. 04494



**06**

KOSMETIK · COSMETICI

MR. BEAR FAMILY

**Bart-Shampoo**  
**Shampoo da barba**

Mr. Bear Family Bart-Shampoo . Sanftes Shampoo mit natürlichen Inhaltsstoffen zum Waschen von Bärten. Beruhigt und befeuchtet die Haut, Reizmindernde Eigenschaften und verleiht dem Bart ein attraktiveres und üppigeres Aussehen, wobei auch seine 3 angenehmen Aromen zur Geltung kommen.

*Shampoo da barba Mr. Bear Family. Shampoo delicato con ingredienti naturali per lavare la barba. Calma e idrata la pelle, grazie alle sue proprietà anti-irritanti, dona alla barba un aspetto più attraente ed esuberante, evidenziando anche i suoi 3 piacevoli aromi.*

250 ml

**Citrus**

REF. 04559



250 ml

**Woodland**

REF. 04560



250 ml

**Wilderness**

REF. 04561

**Rasieröl**  
**Olio da barba**

30 ml

REF. 04495

**Aussteller**  
**Espositore**

REF. 04680

REF. 04558

Enthält 1 Stck.  
je Ref.

Leer

Include 1 u.  
ogni rif.

Vuoto

Mr. Bear Family Rasieröl für eine angenehme Rasur. Hergestellt aus natürlichen Ölen. Dank seiner hohen Dichte wird es nicht von der Haut absorbiert. Es macht den Bart weicher, was die Rasur erleichtert, und fungiert als Schutzschild für die Haut während und nach der Rasur. Dadurch gleitet die Klinge weicher über die Haut. Es hilft auch, Rötungen, Irritationen, Juckreiz und Trockenheit der Haut nach der Rasur zu lindern.

*Olio da barba Mr. Bear Family per una piacevole esperienza di rasatura. A base di oli naturali. Ammorbidisce la barba, facilitando la rasatura e fungendo da scudo protettivo per la pelle durante e dopo la rasatura. Tutto ciò fa sì che la lama scivoli più dolcemente sulla pelle. Aiuta anche ad alleviare arrossamenti, irritazioni, prurito e secchezza della pelle dopo la rasatura.*

**Lippenbalsam**  
**Crema per labbra**

15 ml

REF. 04496

**Pink grape**

15 ml

REF. 04498

**Coco**

15 ml

REF. 04497

**Mint**

Weiche, geschützte Lippen. 100% natürlich und handgefertigt. Mit angenehmen Aromen von rosa Trauben, Minze und Kokosnuss. Nährt, schützt und macht die Lippen von der ersten Anwendung an geschmeidig. Mit Kokosnussöl, Jojoba, Karitébutter, Carnaubawachs und ätherischen Ölen.

Labbra morbide e protette. 100% naturale e fatto a mano. Con piacevoli aromi di uva rosa, menta e cocco. Nutre, protegge e ammorbidisce le labbra fin dalla prima applicazione. Con olio di cocco, jojoba, burro di karité, cera di carnauba e oli essenziali.



**100% natürlicher Alaunstein**  
**Pietra di allume naturale al 100%**

1 u.m.vta 378 box

75 gr

REF.04220



Hand geschritten, um Haut und Irritationen nach der Rasur zu beruhigen

*Tagliata a mano, per lenire la pelle e le irritazioni dopo la rasatura*

**Rasierseife mit Alaun**  
**Sapone da barba con allume**

1 u.m.vta 24 box

100 gr

REF.04219



Rasierseife mit Alaun. Seine einzigartige Formel, die zu 100% auf Alaunstein und Karitébutter basiert, bereitet den Bereich für den Durchgang der Klinge vor und macht die Rasur zu einem sehr angenehmen Ritual.

*Sapone da barba con allume. La sua formula unica al 100% a base di pietra di allume e burro di karité prepara la pelle per il rasoio e rende la rasatura un rituale molto piacevole.*

**Blutstiller Stift**  
**Stick emostatico**

12 u.m.vta 12 box

12 gr

REF.04218



Schüttwar  
 Sfusi  
 REF.04218/01

Blutstillender Stift zur Behandlung von Mikroschnitten bei der Rasur. Hergestellt aus Kalium-Alaun. CE-zertifiziert. Externer und persönlicher Gebrauch. Wird in einer praktischen und sicheren Röhrrchen geliefert

*Stick emostatico per il trattamento dei micro tagli della rasatura. Realizzato con allume di potassio. Certificato CE. Uso esterno e personale. In un tubetto pratico e sicuro.*

**Rasier Set**  
**Kit da barba**

1 u.m.vta 1 box

REF.04221



Bestehend aus:  
 » Holzkasten  
 » Blutstillender Stift 12 gr  
 » Für die Reise, um die Benutzung zu erleichtern.  
 » Rasierseife mit Alaun  
 » Alaunstein 75 gr  
 » Hölzerne Bürste

Composto da:  
 » Cofanetto di legno  
 » Stick emostatico 12 gr  
 » da viaggio per facilitarne l'uso.  
 » Sapone da barba con allume  
 » Pietra di allume 75 gr  
 » Pennello in legno





**Zitronen Rasierwasser regeneriert die natürliche Hautschicht**  
**Lozione per massaggi all'acqua al limone che rigenera lo strato naturale della pelle**

1  
u.m.vta

8  
box

Regenerator des natürlichen Säureschutzmantels der Epidermis der Haut. Im Allgemeinen ist Zitronensäure wirksam gegen Pickel und verstärkte Talgbildung und macht die Haut weicher. Für die tägliche Rasur ohne Schmerzen und lindert sofort den auftretenden Juckreiz. Schließendes Tonikum. Er erzeugt ein außergewöhnliches Gefühl der Frische und hat ein angenehmes Aroma. Empfohlen für fettige Haut. Hydroalkoholische Lösung.

*Rigeneratore dello strato acido naturale della pelle, ed epidermide cutanea. In generale, l'acido limone è efficace contro le macchie e la seborrea facciale e AMMORBIDISCE la pelle. Per radersi quotidianamente senza dolore. Astringente Tonico. Produce una straordinaria sensazione di fresco ed ha un aroma gradevole. Consigliato per la pelle grassa. Soluzione idroalcolica.*

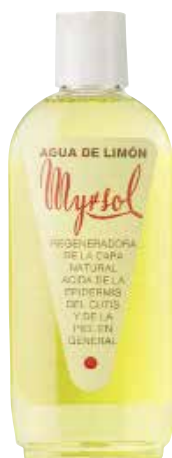

200 ml

REF.04352



180 ml

REF.03866



**Rasierwasser vor und nach der Rasur**  
**Lozione per massaggi Antesol prima e dopo la rasatura**

Allantoin  
Allantoína

1  
u.m.vta

8  
box

Myrsol-Rasierwasser vor der Rasur und nach der Rasur. Fördert die Regeneration geschädigter Hautzellen und reduziert das Schmerzempfinden. Indiziert zur Behandlung trockener Haut als Feuchtigkeitsspender. Das Ergebnis ist eine glattere und gesündere Haut. Empfohlen für trockene Haut. Hydroalkoholische Lösung.

*Lozione per massaggi Myrsol Anteol prima e dopo la rasatura. Favorisce la rigenerazione delle cellule cutanee danneggiate e riduce la sensazione di dolore. Indicato per trattare le pelli secche come idratante. Il risultato è una pelle più liscia e sana. Consigliato per pelli secche. Soluzione idroalcolica.*



200 ml

REF.04650



180 ml

REF.03867

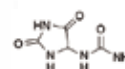

### Aftershave Formel K Tonikum. Erfrischendes Menthol Tonico dopobarba Formula K. Menta rinfrescante

1 u.m.vta 8 box

After Shave Formel K. Seine erfrischende und tonisierende Wirkung hilft, Schmerzen und Irritationen zu lindern.

Ganz gleich, wie empfindlich Ihre Haut ist, sie behält ihre natürliche Feuchtigkeit und Elastizität und beugt so der vorzeitigen Hautalterung vor. Empfohlen für trockene Haut.

Hydroalkoholische Lösung

*Dopobarba Formula K. La sua azione rinfrescante e tonificante aiuta a lenire dolori e irritazioni.*

*Non importa quanto sia delicata la tua pelle, il tonico dopobarba Formula K ne mantiene l'umidità e l'elasticità naturale, prevenendone l'invecchiamento precoce. Consigliato per pelli secche. Soluzione idroalcolica.*



200 ml

REF.04643



180 ml

REF.03872



### Balsamisches Rasierwasser zur Regeneration der Haut nach der Rasur Dopobarba rigenerante della pelle all'acqua balsamica

1 u.m.vta 8 box

Ausgezeichneter Hautregenerator. Beruhigung von Rasurreizungen. Es wird mit Substanzen hergestellt, die aus Rosmarin, Thymian, Lavendel und anderen Pflanzen extrahiert werden, die zur Abschwellung der durch Reiben, Quetschungen und nach der Rasur und Enthaarung angegriffenen Stellen angezeigt sind. Empfohlen für fettige Haut.

Hydroalkoholische Lösung.

*Ottimo rigeneratore della pelle. Calma l'irritazione dovuta alla rasatura. È realizzato con sostanze estratte da rosmarino, timo, lavanda e altre piante indicate per decongestionare le parti interessate da abrasioni, contusioni e dopo la rasatura e la depilazione. Consigliato per pelli grasse.*

*Soluzione idroalcolica.*



200 ml

REF.04642



180 ml

REF.03875



### Alkoholfreie Rasieremulsion für die Massage vor und nach der Rasur Emulsione da barba senza alcool per massaggi prima e dopo la rasatura

1 u.m.vta 8 box



200 ml

REF.04587



180 ml

REF.03869



» Roll-on  
» Roll-on

75 ml

REF.04887

Anwendung: für eine schmerzfreie Rasur ohne Pinsel oder Seife und zur Massage vor und nach der Rasur. Für eine perfekte Rasur für den schwierigsten Bart und für die empfindlichste Haut. Ein Produkt mit überraschender Wirkung. Diese Emulsion ist extrem Feuchtigkeitsspendend, nährend, blutstillend und schmerzlindernd. Geeignet für Koteletten und Bartkonturen. Empfohlen für empfindliche Haut. Nicht-alkoholische Lösung.

*Indicazioni: per una rasatura indolore senza pennello o schiuma e per il massaggio prima e dopo la rasatura. Per una rasatura perfetta delle barbe più difficili e per le pelli più delicate. Un prodotto dagli effetti sorprendenti. Questa emulsione è altamente idratante, nutriente, emostatica, analgesica. Indicato per basette e contorno barba. Consigliato per pelli sensibili. Soluzione non alcolica.*

**Massage F./ Extra**  
*Lozione per massaggi F. extra*

1 u.m.vta 8 box

**After shave**

180 ml

**REF.03877**

Beruhigende Lozione für jede Art von Irritation, die durch die Rasur verursacht wird. Sie verleiht der Haut Glätte, Spannkraft und ein angenehmes Gefühl der Frische, mit heilender und beruhigender Wirkung.

*Lozione lenitiva per qualsiasi tipo di irritazione causata dalla rasatura. Dona alla pelle levigatezza, tono e una piacevole sensazione di freschezza con un effetto curativo e balsamico.*

**Aftershave Metilsol**  
*Lozione per massaggi Metilsol*

1 u.m.vta 8 box

180 ml

**REF.03878**

Es hat heilende und schliessende Eigenschaften und gleicht die Funktion der Talgdrüsen aus, indem es das Auftreten von Pickeln auf der Haut verhindert. Es hilft, Hautirritationen und Infektionen vorzubeugen. Blutstillend wirksam gegen Mikroschnitte bei der Rasur.

Ha proprietà cicatrizzanti e astringenti e riequilibra la funzione delle ghiandole sebacee, prevenendo la comparsa dei brufoli sulla pelle. Aiuta a prevenire le irritazioni e le infezioni della pelle. Emostatica ed efficace contro i micro-tagli.

**Gesichtstonikum Formel C**  
*Tonico per il viso Formula C*

1 u.m.vta 8 box

180 ml

**REF.03874**

Geeignet für die Hautpflege, insbesondere für fettige Haut. Regeneriert die Epidermis, erfrischt und repariert die Haut nach der Rasur. Feuchtigkeits spendend, entspannend und beruhigend empfohlen für fettige Haut. Hydroalkoholische Lösung.

*Indicato per la cura della pelle, in particolare quelle grasse. Rigenera l'epidermide, rinfresca e ripara la pelle dopo la rasatura. Idratante, rilassante e lenitivo indicato per pelli grasse. Soluzione idroalcolica.*

**Rasierwasser Plastic Shave**  
*Lozione per massaggi Plastic Shave*

1 u.m.vta 8 box

180 ml

**REF.03871**

Um eine tägliche Rasur ohne Schmerzen und Beschwerden zu erreichen. Auch sehr geeignet zur Neutralisierung von Mückenstichen und anderen Insekten. Verbessert die Hauttextur und den Hautton sowie das allgemeine Erscheinungsbild, empfohlen für empfindliche Haut. Hydroalkoholische Lösung.

*Per una rasatura quotidiana piacevole e indolore. Molto adatta anche per neutralizzare punture di zanzara e altri insetti. Migliora la consistenza e il tono della pelle e l'aspetto in generale. Consigliata per pelli sensibili. Soluzione idroalcolica.*

**Rasierwasser Electric**  
**Lozione per massaggi Electric**

1 u.m.vta  
8 box

REF.03868



180 ml



Lotion zum einölen der Haut und der elektrischen Maschine vor der Rasur. Lässt das Gerät besser gleiten, um Reibung und Hautreizungen zu verringern. Alkohollösung.

Lozione indicata per lubrificare la pelle e il rasoio elettrico prima della rasatura. Facilita lo scorrimento del rasoio per ridurre l'attrito e l'irritazione della pelle. Soluzione non alcolica.

**Aftershave Blue**  
**Lozione per massaggi Blue**

1 u.m.vta  
8 box

REF.03873



180 ml

Myrsol-After Shave Blue. Die perfekte Ergänzung nach dem Rasieren wegen seiner tonisierenden und beruhigenden Eigenschaften. Hervorragend geeignet für Hauterkrankungen: Entzündungen, Irritationen, Austrocknung. Verleiht Frische, Spannkraft, Vitalität. Es hat einen unverwechselbaren Duft, der bei Hautkontakt anhält und für trockene Haut empfohlen wird. Hydroalkoholische Lösung.

Myrsol-After shave Blue. Il perfetto complemento dopobarba per le sue proprietà toniche e lenitive. Ottimo per le seguenti condizioni della pelle: infiammazioni, irritazioni, disidratazione. Dona freschezza, tonicità, vitalità. Ha un profumo caratteristico che dura a contatto con la pelle. Consigliata per pelli secche. Soluzione idroalcolica.



**Als Hommage an den Gründer der Marke**  
**In omaggio al fondatore del marchio**



1 u.m.vta  
8 box

180 ml

REF.04701

Myrsol-Massage Don Miguel 1919. Es handelt sich um ein Aftershave mit einer neu erfundenen Formel mit Eigenschaften zur Reparatur der Haut nach der Rasur. Es hat einen besonderen und eleganten Duft.

Lozione per massaggi Myrsol Don Miguel 1919. È un dopobarba con una formula reinventata e con proprietà adatte a riparare la pelle dopo la rasatura. Ha una fragranza speciale ed elegante.



1 u.m.vta  
6 box

235 ml

REF.04702

Myrsol Köln Don Miguel 1919. Parfüm mit einer ausgesprochen männlichen Jasminbasis.

Colonia Myrsol Don Miguel 1919. Fragranza a base di gelsomino decisamente maschile.



**Don Miguel-Sonderausgabe**  
**Edizione speciale Don Miguel**



1 u.m.vta  
12 box

150 ml

REF.04802

Myrsol-Rasiercreme Don Miguel 1919 mit Lanolin zum Auftragen mit einem Pinsel.

Crema da barba Myrsol Don Miguel 1919 con lanolina da applicare a pennello.

**Jasmin · Gelsomino**

**Flüssige Rasierseife mit Pinsel**  
**Sapone liquido per la rasatura a pennello**

» Rasierschaum mit Lanolin, für die Rasur mit Pinsel

» Crema da barba alla lanolina, per radersi con pennello

1 u.m.vta 8 box  
200 ml  
REF.03876



1 u.m.vta 12 box  
1000 ml  
REF.06242



**Vitalisierendes Haarwasser**  
**Lozione vitalizzante per capelli**

» Kopfhautregenerator, Anti-Schuppen und Anti-Talg  
» OHNE KLARSPÜLEN

» Rigenerante del cuoio capelluto, antiforfora e anti-seborroica  
» SENZA RISCIAQUO

1 u.m.vta 6 box  
235 ml  
REF.04644



1 u.m.vta 12 box  
1000 ml  
REF.04645



## Blutstillende Streichhölzer 20 Stück

### Emostatico in fiammiferi 20 servizi

1 u.m.vta  
16 box

- » Box mit 50 Streichholzbriefchen. 20 blutstillende Streichhölzer
- » 100% natürliche, leicht anzuwendende, zu transportieren und antiseptische Formel
- » Präsentationsbox nach Einheiten
- » 50 Streichholzbriefchen pro Schachtel
- » 20 Streichhölzer in jedem Briefchen
- » 300 gr
- » Hergestellt in PRC

- » *Espositore 50 pacchetti 20 servizi di emostatico a fiammifero*
- » *Formula 100% naturale, facile da usare, da trasportare e antisettica*
- » *Scatola di presentazione per unità*
- » *50 pacchetti per scatola*
- » *20 fiammiferi in ogni pacchetto*
- » *300 gr*
- » *In PRC*



REF.06194

## Pomade THE LEGENDS

### Pomata THE LEGENDS

1 u.m.vta  
12 box

120 ml

REF.06195



Leicht anzubringen, um zu gestalten und wieder zu entfernen, starker Halt

- » Starker Halt - für den ganzen Tag
- » Sauberer, milder Geruch
- » Weiche Konsistenz
- » Helle Farbe
- » Mittlere Helligkeit
- » Für alle Stile geeignet
- » Einfach anzuwenden
- » Weiße Plastikdose
- » Vintage-Stil
- » 120 ml / 4 oz
- » In der EU hergestellt

*Facile da applicare, rimodellare e rimuovere, tenuta forte*

- » *Tenuta forte - per tutto il giorno*
- » *Odore delicato e pulito*
- » *Consistenza leggera*
- » *Colore chiaro*
- » *Luminosità media*
- » *Adatto a tutti i tipi di stili*
- » *Facile da applicare*
- » *Barattolo di plastica bianco*
- » *Stile vintage*
- » *4 once / 120 ml*
- » *Made in UE*

## Gel THE LEGENDS

### Gel THE LEGENDS

1 u.m.vta  
12 box

220 ml

REF.06197



Produkt der "alten Schule" mit starker Fixierung, nährend, restyling.

- » Starker Halt - den ganzen Tag lang
- » Parfüm
- » Geschmeidige Konsistenz
- » Halbttransparente rote Farbe
- » Mittlerer Glanz auf nassem Haar
- » Halbmatt auf trockenem Haar
- » Alle Arten von Stilen
- » Weiße Plastikdose
- » Vintage-Stil
- » 220 ml / 4 Unzen
- » Produziert in der UE

*Prodotto "old school" con tenuta forte, nutriente e restyling.*

- » *Tenuta forte - per tutto il giorno*
- » *Fragranza*
- » *Consistenza delicata*
- » *Colore rosso semitrasparente*
- » *Lucentezza media sui capelli bagnati*
- » *Finitura opaca media su capelli asciutti*
- » *Tutti i tipi di stili*
- » *Barattolo di plastica bianco*
- » *Stile vintage*
- » *4 once / 220 ml*
- » *Made in UE*

## Anti-Haarausfall Shampoo Shampoo anti caduta



- » Shampoo, das speziell zur Bekämpfung von Haarausfall erstellt wurde, da es Proteine und Bionährstoffe pflanzlichen Ursprungs kombiniert, die als abschwellende und revitalisierende Mittel wirken und Reizungen verhindern
- » Reinigt tief, entfernt die sich auf der Kopfhaut bildenden Öle und lässt das neue Haar ungehindert wachsen.
- » Das Haar wird weich, glänzend und seidig

» *Shampoo specificamente formulato per combattere la caduta dei capelli, in quanto combina proteine e bionutrienti di origine vegetale che agiscono come decongestionanti e rivitalizzanti, evitando così le irritazioni.*

» *Deterge in profondità, eliminando i grassi che si formano sul cuoio capelluto, permettendo così ai nuovi capelli di crescere senza impedimenti*

» *Capelli morbidi, lucenti e setosi*



1 u.m.vta 12 box

1000 ml

REF.03566

1 u.m.vta 6 box

400 ml

REF.03553

## Ampullen gegen Haarausfall Fiale anti caduta

Die besten Nährstoffe für die Kopfhaut sind Proteine pflanzlichen Ursprungs. Sie verbessern die Aufnahme derselben und begünstigen die Sauerstoffanreicherung des Haarfollikels, wodurch der Haarausfall verringert wird. Die pflanzlichen Nährstoffe wirken auch als abschwellende und revitalisierende Mittel, um Reizungen zu vermeiden. Keratin repariert und stärkt das Haar und verleiht ihm Volumen und Glanz.

*I migliori nutrienti per il cuoio capelluto sono le proteine vegetali. Queste fiale ne aumentano l'assorbimento e favoriscono l'ossigenazione del follicolo pilifero, riducendo così la caduta dei capelli. I nutrienti vegetali agiscono anche come decongestionanti e rivitalizzanti, evitando così le irritazioni. La cheratina ripara e rinforza i capelli, donandogli volume e lucentezza.*

- » 12 Ampullen zur Vorbeugung von Haarausfall
- » Präventionsshampoo 400 ml

- » 12 Fiale anti caduta
- » Shampoo prevenzione anti caduta 400 ml

1 u.m.vta 6 box

REF.03550

- » 12 Ampullen zur Vorbeugung von Haarausfall
- » 10 ml pro Ampulle

- » 12 Fiale anti caduta
- » 10 ml ogni fiala

1 u.m.vta 6 box

12 u

REF.03551



## Haarfasern Polvere di fibre



22 gr

- » Mit Dosiermöglichkeit
- » Für Männer und Frauen. Ideal bei Haardichteverlust. Tarnung von Bereichen mit wenig Haar schnell und natürlich
- » Haftet am Haar und verleiht ihm mehr Volumen und Dicke
- » Einfaches Auftragen durch Schütteln des Glases über die Applikationsfläche
- » Erhältlich in 6 Farben: schwarz, dunkelbraun, mittelbraun, hellbraun, dunkelblond und hellgrau passend zur natürlichen Haarfarbe

- » *Con dosatore*
- » *Per uomini e donne. Ideale contro la perdita di densità capillare. Nasconde le aree assottigliate in modo rapido e naturale*
- » *Aderisce ai capelli donando loro maggior volume e spessore*
- » *Si applica facilmente agitando il barattolo sull'area di applicazione*
- » *Disponibile in 6 colori: nero, castano scuro, castano medio, castano chiaro, biondo scuro e grigio chiaro che si adattano al tono del colore naturale dei capelli*



Schwarz · Nero

REF.06436/50

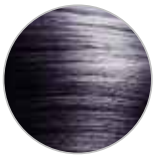

Hellgrau · Grigio chiaro

REF.06436/72

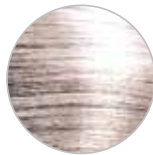

Dunkelblond · Biondo scuro

REF.06436/66

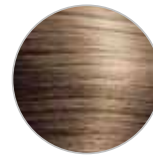

Dunkelbraun · Castano scuro

REF.06436/67



Mittelbraun · Castano medio

REF.06436/76

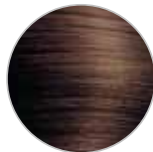

Hellbraun · Castano medio

REF.06436/65



## Fixier-Zerstäuber Atomizzatore per fibra capillare



REF.07208

- » Benutzerfreundlich
- » Ermöglicht eine gleichmäßigere Verteilung der Haarfasern an bestimmten Stellen.
- » Ermöglicht, dass die Fasern viel leichter an Ihrem natürlichen Haar anhaften. Es wird eine geringere Menge des Produkts benötigt, um den gewünschten Look zu erzielen.
- » Leicht zu lagern

### VERWENDUNG:

Geben Sie die Haarfasern in die Glasflasche und bringen Sie den Zerstäuber an, um sie zu pulverisieren. Drücken Sie hierfür die Pumpe nach oben und nach unten.

- » *Facile da usare*
- » *Consente una distribuzione più uniforme delle fibre capillari in zone specifiche.*
- » *Permette alle fibre di aderire ai tuoi capelli naturali molto più facilmente. È necessario meno prodotto per ottenere l'aspetto desiderato.*
- » *Facile da riporre*

### COME USARE:

Versare le fibre dei capelli nella bottiglia di vetro e sistemare l'atomizzatore per nebulizzarle. Premere la pompetta a tale scopo.

NEW





## Haarfaser-Lack Lacca per fibra capillare

Für maximale Fixierung  
und Unterstützung der  
Fasern

*Per una massima  
fissazione e tenuta delle  
fibre*



100 ml

REF.06649



## Verkaufsträger haarfasern (als geschenk) Espositore per fibre capillari

- » Umfasst 6 Farbtöne für haarfasern + fixierlack
- » Ref. 06436/50 Schwarz 22 g
- » Ref. 06436/72 Hellgrau 22 g
- » Ref. 06436/66 Dunkelblond 22 g
- » Ref. 06436/67 Dunkelbraun 22 g
- » Ref. 06436/76 Mittelbraun 22 g
- » Ref. 06436/65 Hellbraun 22 g
- » Ref. 06649 Fixierlack haarfasern 100 ml.

- » Include 6 tonalità di fibra capillare + lacca fissante
- » Rif. 06436/50 Nero 22g.
- » Rif. 06436/72 Grigio chiaro 22g.
- » Rif. 06436/66 Biondo scuro 22g.
- » Rif. 06436/67 Castano scuro 22g.
- » Rif. 06436/76 Castano medio 22g.
- » Rif. 06436/65 Castano chiaro 22g.
- » Rif. 06649 Lacca fissante fibre capillari 100 ml.



100 ml

REF.07801

NEW



**Wachs-Roll-on Mann**  
**Roll-on cera uomo**



Das Roll-on-Haarentfernungssystem ist optimal für diejenigen Fachleute, die die besten Ergebnisse erzielen möchten. Die Harze, mit denen wir die Wachse herstellen, können bei einer höheren Temperatur als niedrig schmelzende Wachse verwendet werden, mit dem Vorteil, dass sie mit einem dünneren Streifen aufgetragen werden. Auf diese Weise kühlt das Wachs fast augenblicklich ab und das Wärmeempfinden auf der Haut wird minimiert. Das Wachs lässt sich mit den Hygienestreifen leicht entfernen. Kombinierte Staffelpreise Seite 556-557-558

*Il sistema di depilazione roll-on è ottimale per quei professionisti che cercano di ottenere i migliori risultati. Le resine con le quali produciamo le cere possono essere utilizzate ad una temperatura più elevata rispetto alle cere a basso punto di fusione, con il vantaggio di essere applicate mediante una striscia più sottile. Così, la cera si raffredda quasi istantaneamente e la sensazione di calore sulla pelle è ridotta al minimo. La cera si rimuove facilmente con le salviette igieniche. Prezzi scalati combinabili pagina 556-557-558*



100 ml

REF.03858



07

# Möbel und dekoration

COMPLEMENTI  
D'ARREDO

*Barberpole, Barbierstuhl, Waschbecken,  
Kinderstühle, Spiegel und Arbeitswagen...*

*Polo barber, poltrone barber, lavatesta, specchi,  
trolleys & poltrone per bambini.*



## Barberpole Barberpole

### Palo del barbiere

Con cable  
Con cavo



Der Ursprung der rot-weißen Barbierstange geht auf das Mittelalter zurück, als die Barbier neben der Zahnextraktion auch Operationen an ihren Kunden vornahmen. Der Pfosten hatte ursprünglich oben eine Bronzeschale, die das Gefäß darstellte, in dem sie die Blutegel aufbewahrten, und unten eine weitere, in Anspielung auf das Gefäß, das das Blut aufnahm. Die Stange selbst symbolisiert den Stab oder Stock, den der Patient während des Eingriffs hielt, um den Blutfluss zu erleichtern. Aus diesem Grund wird der Barbierstab mit den angebotenen Dienstleistungen, einschließlich des Aderlasses, in Verbindung gebracht. In der Vergangenheit wurde sie durch blutige Verbände dargestellt, die um einen Pfahl gewickelt waren.

L'origine del polo barber rosso e bianco risale al Medioevo, quando i barbieri eseguivano anche interventi chirurgici per i loro clienti, nonché estrazioni dentali. Il polo aveva originariamente una bacinella di bronzo nella parte superiore rappresentante il contenitore dove venivano conservate le sanguisughe e un'altra nella parte inferiore alludente al contenitore per il sangue estratto. Il polo stesso simboleggia il palo o il bastone che il paziente afferrava durante la procedura per facilitare il flusso di sangue. Ecco perché il polo barber è associato ai servizi offerti, compresi i salassi. Storicamente era formato da bende insanguinate avvolte attorno a un palo.

REF. 04578

REF. 04745



- » Leistung: 13W
- » Schleuderdrehzahl: 50-60 U/MIN
- » Leuchtende schwarze rotierende Barberpole Ø 20 cm
- » Mit Licht und Schwenkmöglichkeit
- » Spannung: 220-240V~
- » Frequenz: 50/60 Hz

- » Potenza: 13W
- » Velocità di rotazione: 50-60 RPM
- » Polo barber nero luminoso e rotante Ø 20 cm
- » Luce e rotazione opzionali
- » Voltaggio: 220-240V~
- » Frequenza: 50/60 Hz



- » Leistung: 12W
- » Schleuderdrehzahl: 50-60 U/MIN
- » Vintage Barberpole-Laterne
- » Mit Licht und Schwenkmöglichkeit
- » Spannung: 220-240V~
- » Frequenz: 50/60 Hz

- » Potenza: 13W
- » Velocità di rotazione: 50-60 RPM
- » Polo barber nero luminoso e rotante Ø 20 cm
- » Luce e rotazione opzionali
- » Voltaggio: 220-240V~
- » Frequenza: 50/60 Hz

REF. 04744

REF. 04743

REF. 04946



- » Leistung: 13W
- » Schleuderdrehzahl: 50-60 U/MIN
- » Verchromte Barberpole mit Leuchtzifferblatt
- » Mit Licht und Schwenkmöglichkeit
- » Spannung: 220-240V~
- » Frequenz: 50/60 Hz

- » Potenza: 13W.
- » Velocità di rotazione: 50-60 RPM
- » Cromato con quadrante luminoso
- » Luce e rotazione opzionali
- » Voltaggio: 220-240V~
- » Frequenza: 50/60 Hz



- » Leistung: 17W
- » Schleuderdrehzahl: 50-60 U/MIN
- » Kleine verchromte Barberpole
- » Mit Licht und Schwenkmöglichkeit
- » Spannung: 220-240V~
- » Frequenz: 50/60 Hz

- » Potenza: 17W.
- » Velocità di rotazione: 50-60 RPM
- » Piccolo cromato
- » Luce e rotazione opzionali
- » Voltaggio: 220-240V~
- » Frequenza: 50/60 Hz



- » Leistung: 13W
- » Schleuderdrehzahl: 50-60 U/MIN
- » Große verchromte Barberpole
- » Mit Licht und Schwenkmöglichkeit
- » Spannung: 220-240V~
- » Frequenz: 50/60 Hz

- » Potenza: 13W.
- » Velocità di rotazione: 50-60 RPM
- » Cromato grande
- » Luce e rotazione opzionali
- » Voltaggio: 220-240V~
- » Frequenza: 50/60 Hz

### Barbierstuhl SPRINGFIELD

#### Poltrona barber SPRINGFIELD



Der neue Springfield Barbierstuhl wurde in einem modernen Stil entworfen, ohne jedoch seine Funktionalität und klassischen Linien zu verlieren. Der Sessel verfügt über eine Hydraulikpumpe, mit der wir den Sitz heben und senken können, so dass wir unseren Kunden auf die Höhe bringen können, die für unsere Arbeit am besten geeignet ist. Der Schaumstoff der Rückenlehne hat eine Dicke von 6 cm und des Sitzes von 11 cm, dadurch passt sich unser Kunde gut an den Sessel an und ist sehr bequem. Die Kopfstütze ist abnehmbar und verstellbar, so dass wir sie an jede Arbeit anpassen können. Die Rückenlehne des Stuhls kann um 108 Grad gekippt werden. Gleichzeitig mit der Neigung der Rückenlehne wird auch die Fußstützenstruktur gekippt, um maximalen Komfort zu gewährleisten.

La nuova poltrona da barbiere Springfield è progettata con uno stile moderno ma senza perdere la sua funzionalità e le sue linee classiche. La poltrona è composta da una pompa a gas che permette di alzare e abbassare la seduta, in modo da poter posizionare il cliente all'altezza più adatta per il nostro lavoro. La gommapiuma dello schienale ha uno spessore di 6 cm e il sedile di 11 cm, questo farà sì che il nostro cliente si adatti bene alla poltrona e si senta completamente a suo agio. Il poggiatesta è removibile e regolabile, in questo modo possiamo adattarlo ad ogni esigenza. Lo schienale della sedia può essere inclinato di 108 gradi, contemporaneamente, mentre incliniamo lo schienale, anche la struttura del poggiatesta si inclinerà per offrire il massimo comfort.



REF.06955

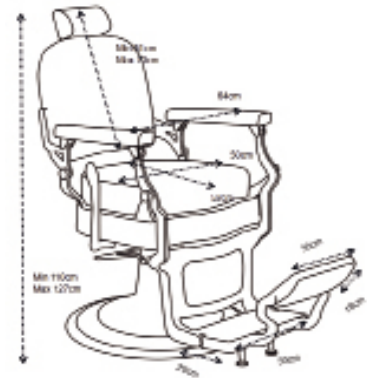

### Barbierstuhl STAFFORD

#### Poltrona barber STAFFORD



Der neue Stafford-Barbierstuhl wurde mit Retro-Style entworfen. Er gilt als "Vintage"-Sessel, da er Stahl und Stoff mit einem abgenutzten Effekt vermischt. Mit der Qualität der neuesten Generation ist er mit einer Hydraulikpumpe zur Regulierung der Sitzhöhe ausgestattet. Die Fußstütze ist drehbar und die Rückenlehne ist neigbar. Die Kopfstütze ist abnehmbar und auch verstellbar, um sie an jeden Arbeitsplatz anzupassen. Erhältlich in Schwarz und Braun.

Neigung von etwa 120 Grad.

La nuova poltrona da barbiere Stafford è progettata con linee e finiture retró. Viene considerata una poltrona "vintage" in quanto combina acciaio e tessuto per ottenere un effetto consumato. Di qualità all'avanguardia, è dotata di una pompa a gas per regolare l'altezza della seduta. Il poggiatesta è girevole e lo schienale è reclinabile. Il poggiatesta è removibile e anche regolabile per poterlo così adattare ad ogni esigenza. Disponibile nei colori nero e marrone.

Inclinazione di circa 120 gradi.



REF.06956/50

REF.06956/69

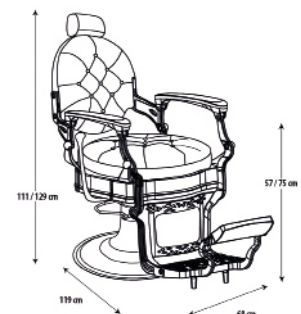

## Barbierstuhl VIGOR

### Poltrona barber VIGOR



Der Barbierstuhl VIGOR ist in einem modernen Stil entworfen, ohne jedoch seine Funktionalität und seine klassischen Linien zu verlieren. Der Sessel verfügt über eine Hydraulikpumpe, die es ermöglicht, den Sitz zu heben und zu senken, so dass unser Kunde in der Höhe platziert werden kann, die der Arbeit am besten entspricht. Der Schaumstoff der Rückenlehne ist 13,5 cm und der Schaumstoff des Sitzes 11,5 cm dick, so dass sich der Klient gut an den Sessel anpassen und sehr bequem sitzen kann. Die Kopfstütze ist abnehmbar und verstellbar, so dass sie an jeden Arbeitsplatz angepasst werden kann. Die Rückenlehne des Stuhls kann um 130 Grad gekippt werden, während gleichzeitig die Rückenlehne gekippt wird. Die Struktur der Fußstütze wird sich für maximalen Komfort ebenfalls neigen.

*La poltrona da barbiere VIGOR è progettata con uno stile moderno ma senza perdere la sua funzionalità e le sue linee classiche. La poltrona è composta da una pompa a gas che permette di alzare e abbassare la seduta, in modo da poter posizionare il cliente all'altezza più adatta per il nostro lavoro. La gommapiuma dello schienale ha uno spessore di 13,5 cm e il sedile di 11,5 cm, questo farà sì che il cliente si adatti bene alla poltrona e si senta completamente a suo agio. Il poggiatesta è removibile e regolabile, in questo modo è possibile adattarlo ad ogni esigenza. Lo schienale della sedia può essere inclinato di 130 gradi allo schienale. Mentre si inclina lo schienale, allo stesso tempo, anche la struttura del poggiatesta si inclinerà per offrire il massimo comfort.*



REF.04888

REF.04888/73

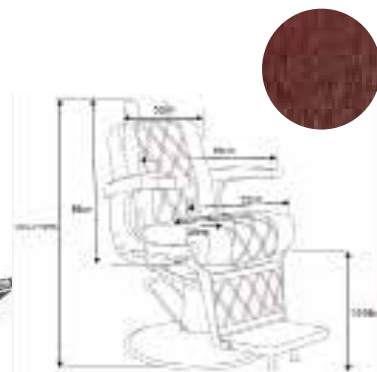

## Barbierstuhl RETRO

### Poltrona barber RETRO



Der Barbierstuhl RETRO wurde mit den besten Materialien hergestellt, das Design ist vom Vintage-Stil inspiriert, ohne jedoch den Komfort bei der Gestaltung zu vergessen. Der Sessel verfügt über eine Hydraulikpumpe, mit der wir den Sitz heben und senken können, so dass wir unseren Kunden auf die Höhe bringen können, die für unsere Arbeit am besten geeignet ist. Der Schaumstoff der Rückenlehne ist 11,5 cm und der Sitz 13,5 cm dick, so dass sich unser Kunde gut an den Sessel anpassen und sehr bequem sitzen kann. Die Kopfstütze ist abnehmbar und verstellbar und wir können sie an jeden Kunden anpassen. Die Rückenlehne des Stuhls kann bis zu 120 Grad gekippt werden. Gleichzeitig mit der Neigung der Rückenlehne wird sich auch die Fußstützenstruktur neigen, um maximalen Komfort zu gewährleisten.

*La poltrona da barbiere RETRO è stata realizzata con i migliori materiali, il design si ispira allo stile vintage, ma durante la progettazione non è stato trascurato il comfort. La poltrona è composta da una pompa a gas che permette di alzare e abbassare il sedile, in modo da poter posizionare il cliente all'altezza più adatta per il nostro lavoro. La gommapiuma dello schienale ha uno spessore di 11,5 cm e il sedile di 13,5 cm, questo farà sì che il nostro cliente si adatti bene alla poltrona e si senta completamente a suo agio. Il poggiatesta è removibile e regolabile, in questo modo possiamo adattarlo ad ogni cliente. Lo schienale della sedia può essere inclinato di 120 gradi, contemporaneamente, mentre incliniamo lo schienale, anche la struttura del poggiatesta si inclinerà per offrire il massimo comfort.*



REF.04889

REF.04889/73

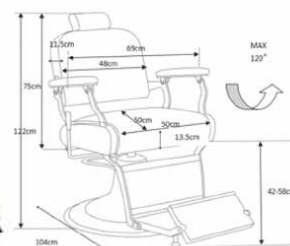

## Barbierstuhl CLASSIC

### Poltrona barber CLASSIC



Der Barbierstuhl CLASSIC mit klassischen Linien und modernster Verarbeitung. Er ist mit einer Hydraulikpumpe zur Regulierung der Sitzhöhe ausgestattet. Die Fußstütze ist schwenkbar und die Rückenlehne ist verstellbar, um dem Kunden maximalen Komfort zu bieten. Der Schaumstoff der Rückenlehne ist 2,5 cm und der Sitz 7,5 cm dick, so dass sich der Kunde sehr wohl fühlen wird. Auch die Kopfstütze ist abnehmbar und verstellbar, so dass sie an jeden Arbeitsplatz angepasst werden kann. Erhältlich in drei Farben: schwarz, granat und grün.

La poltrona da barbiere CLASSIC si distingue per linee classiche e finiture di ultima generazione. È dotata di una pompa a gas per regolare l'altezza della seduta. Il poggiatesta è girevole e lo schienale è reclinabile per offrire il massimo comfort al cliente. La gommapiuma dello schienale ha uno spessore di 2,5 cm e il sedile di 7,5 cm, questo farà sì che il cliente si adatti bene alla poltrona e si senta completamente a suo agio. Anche il poggiatesta è removibile e anche regolabile per poterlo così adattare ad ogni esigenza. Disponibile in tre colori: nero, granata e verde.

REF.06087/50

REF.06087/73

REF.06087/62

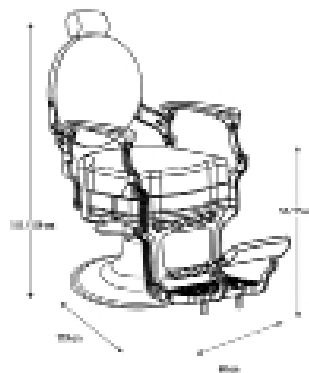

## Hydraulischer Barbierstuhl MODERNIS

### Poltrona barber MODERNIS



REF. 03628

- » Dreht sich um 360°
  - » Breite von Arm zu Arm 57 cm
  - » Kopfstütze 19 x 13 cm
  - » Rückenlehne 51 x 41 cm
  - » Neigbar um 130°
- 
- » Ruota di 360°
  - » Larghezza da bracciolo a bracciolo: 57 cm
  - » Poggiatesta 19 x 13 cm
  - » Schienale 51 x 41 cm
  - » Reclinabile 130°



**Hydraul. Stuhl zur individuellen Gestaltung**  
**Poltrona barber, personalizzabile**

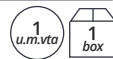

REF.04508/01



### GESTALTE DEINEN BARBIERSTUHL

1. ENTSCIEDEN SIE DIE FARBE DES SOCKELS
2. WÄHLEN SIE DIE FARBE DER POLSTERUNG

- » Stuhlgestell: Aluminiumguss
- » Die Chromteile sind aus Bronze und Eisen
- » Die Struktur, auf der die Polsterung angebracht wird, besteht aus Kiefernholz.
- » Zertifizierte Schaumstoffe und Beschichtungen
- » Sockel mit lackiertem Polyester beschichtet (gleiches System wie bei Autos)

### PERSONALIZZA LA TUA POLTRONA

1. DECIDI IL COLORE DELLA BASE
2. SCEGLI IL COLORE DEL TUO SEDILE

- » Struttura della sedia: lega di alluminio
- » Le parti cromate sono in bronzo e ferro
- » La struttura su cui poggia il rivestimento è in pino
- » Imbottitura e rivestimenti certificati
- » Base rivestita in poliester verniciato (stesso sistema delle auto)



## Neigbarer Stuhl Poltrona reclinabile



- » Neigung 130° / Hydraulik
- » Breite von Arm zu Arm: 57 cm
- » Breite der Kopfstütze: 19 cm
- » Rückenlehne: 51 x 41 cm
- » Kopfstützen Höhe: 13 cm
- » Abstand zwischen Rückenlehne und Kopfstütze: 14 cm
- » Gewicht: 32,5 kg
- » Abnehmbarer Kopf mit einer Verstellung

- » Reclinabile 130° / idraulica
- » Larghezza da bracciolo a bracciolo: 57 cm
- » Larghezza del poggiatesta della sedia: 19 cm
- » Schienale: 51 x 41 cm
- » Altezza del poggiatesta: 13 cm
- » Distanza tra schienale e poggiatesta: 14 cm
- » Peso: 32,5 kg
- » Poggiatesta smontabile con una posizione



REF. 02975/50

## Barbierstuhl TRADITIONAL Poltrona barber TRADITIONAL



Der TRADITIONAL Barbierstuhl wurde als nüchterner und leicht zu handhabender Stuhl hergestellt, im Vintage Stil, ohne den Komfort zu vergessen. Er ist mit einer Hydraulikpumpe zur Regulierung der Sitzhöhe und einer verstellbaren Rückenlehne ausgestattet, um dem Kunden maximalen Komfort zu bieten. Der Schaumstoff des Rückens hat eine Dicke von 9 cm und des Sitzes von 10 cm, so dass sich der Kunde gut an den Sessel anpassen und sich sehr wohl fühlen kann. Die Kopfstütze ist abnehmbar und auf verschiedene Höhen einstellbar. Es hat auch eine bequeme Fußstütze.

La poltrona da barbiere TRADITIONAL è stata realizzata come una sedia sobria e maneggevole, con uno stile molto vintage, senza dimenticare il comfort. È dotata di una pompa a gas per regolare l'altezza della seduta e di uno schienale reclinabile per offrire il massimo comfort al cliente. La gommapiuma dello schienale ha uno spessore di 9 cm e il sedile di 10 cm, questo farà sì che il cliente si adatti bene alla poltrona e si senta completamente a suo agio. Il poggiatesta è rimovibile e regolabile a diverse altezze. Dispone inoltre di un comodo poggiatesta.

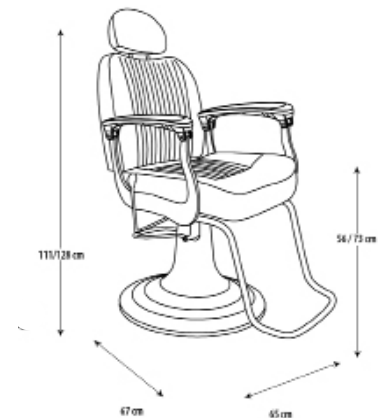

REF.06089/50

### Waschbecken TRADITIONAL Poltrona lavatesta TRADITIONAL



Das Waschbecken TRADITIONAL wurde in Anlehnung an den Stuhl TRADITIONAL (ref.06089/50) wurde als nüchternes und sehr altertümliches Waschbecken hergestellt, ohne dabei den Komfort zu vergessen. Vervollständigen Sie die Gestaltung Ihres Salons mit diesem Waschbecken!

La poltrona lavatesta TRADITIONAL sulla linea della poltrona barber TRADITIONAL (rif. 06089/50) è stata realizzata come una lavatesta dallo stile sobrio e molto vintage, senza però dimenticare il comfort. Completa il design del tuo salone con questo lavatesta!



REF.06090/50

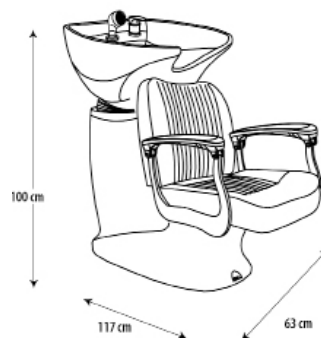

### Waschbecken STAFFORD Poltrona lavatesta STAFFORD



Das Waschbecken Stafford, das in der Linie des "Traditional" Barbierstuhls (ref.06089/50) design ist, folgt ebenfalls der Ästhetik des "traditionellen" Waschbeckens, jedoch mit dem Unterschied, dass das Waschbecken Stafford es aus Stahl gefertigt und eine abgenutzte Oberfläche "vintage" auf dem Sitz hat.

La poltrona lavatesta Stafford, seguendo la linea della poltrona da barbiere "tradizionale" (rif.06089/50) segue anche l'estetica della poltrona lavatesta "tradizionale" ma con la differenza che la poltrona lavatesta Stafford si caratterizza per essere realizzata in acciaio e con una finitura "vintage" sulla seduta.



REF.06957/69

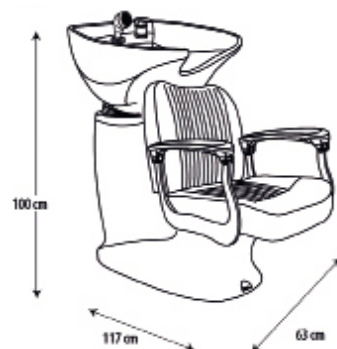

## Waschbecken STIL

### Poltrona lavatesta STIL



- » Armlehnen und Bedienelemente aus Chrom
- » Keramikbecken und Glasfasersockel
- » Schiebesitz
- » Sockellänge 76 cm
- » Sitzbreite 48 cm
- » Höhe der Rückenlehne 41 cm
- » Keramikbecken 57 x 50 x 20 cm
- » Gesamthöhe 95 cm

- » Braccioli e rubinetto cromati
- » Lavello in ceramica e base in fibra di vetro
- » Sedile scorrevole
- » Lunghezza base 76 cm
- » Larghezza sedile 48 cm
- » Altezza schienale 41 cm
- » Lavello in ceramica 57 x 50 x 20 cm
- » Altezza totale 95 cm

REF. 02841

REF. 02841/54

REF. 02841/58

- » \* Ersatzteile verfügbar
- » \*Parti di ricambio disponibili



## Kinderstühle

### Poltrone per bambini



Hochwertige Kinderstühle, aus Metall und im Vintage-Stil. Es handelt sich um ein neues und revolutionäres Konzept, das die Erfahrung, zum Friseur zu gehen, angenehm und frei von Angst machen soll. Tretautos, die funktionieren, wenn sie aus der Halterung entfernt werden. Dekorative Lichter, ohne Hupe und Sicherheitsgurt. Durch Drehen des Lenkrades werden die Vorderräder bewegt.

*Poltrone per bambini di alta qualità, realizzate in metallo e con uno stile vintage. È un concept nuovo e rivoluzionario pensato per rendere piacevole e senza capricci l'esperienza di andare dal parrucchiere ai bambini. Auto a pedali che funzionano se rimosse dal piedistallo. Luci decorative, senza clacson e cintura di sicurezza. Girando il volante, le ruote anteriori si muovono.*

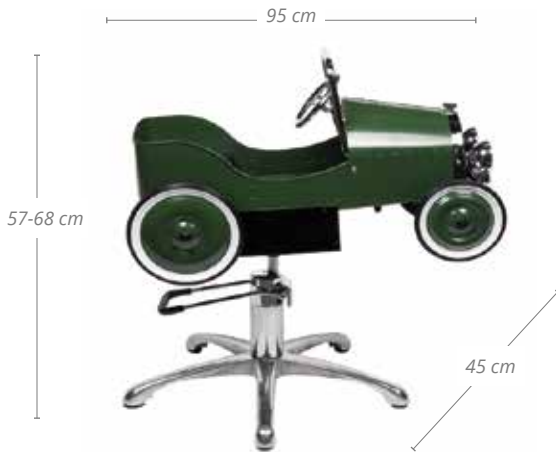

24 kg

REF.04728



26,8 kg

REF.04727



### Spezialstuhl für Kinder

Poltrona speciale per bambini



54-79 cm

REF.02733

### Sitzkissen für Kinder

Cuscini speciali per bambini



Wir haben auch spezielle Kissen, die für jeden Friseurstuhl geeignet sind und dem Profi ein komfortableres Arbeiten ermöglichen, da sie das Kind auf die ideale Höhe bringen.

Disponiamo inoltre di cuscini speciali adatti a qualsiasi poltrona da parrucchiere che permettono al professionista di lavorare più comodamente, in quanto sollevano il bambino all'altezza ideale.



REF.04506/50



REF.04506/58



REF.04506/59



REF.04506/60

### Sitzkissen für Kinder

Cuscini speciali per bambini



REF.07329/50



### Sitzkissen für Kinder

Cuscini speciali per bambini



REF.03939

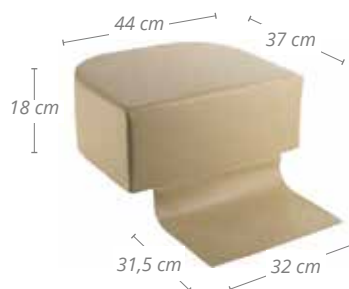

REF.04506/69

### BARBER Wandspiegel Specchio da parete BARBER



REF.06091

Der Wandspiegel BARBER im Vintage-Stil ist funktionell und praktisch dank seines Regalsystems, das es Ihnen ermöglicht, die gewünschten Objekte abzustellen. Er verleiht Ihrem Salon einen "Old-School"-Touch!

*Lo specchio da parete BARBER, in stile vintage, è funzionale e pratico grazie alla sua mensola in quanto permette di appoggiare gli oggetti che si vuole. Dai un tocco "old school" al tuo salone!*



### Rustikaler Frisiertisch der Barber Line Specchio rustico con mensola Barber Line



REF.06670

Frisierkommode aus Polyurethanharz auf mdf-Basis, einem Material mit besseren Eigenschaften als Holz in Bezug auf Festigkeit und Stabilität. Sicherheitsgeprüft feuerfest, selbstlöschend und antibakteriell. Oberfläche in rustikalem Holz mit zwei Zierteilen, die schwarzes Eisen imitieren. Holzähnlicher Touch, perfekte Imitation.

*Specchio con mensola realizzato in resina poliuretanic a base di mdf, un materiale con proprietà migliori del legno in termini di resistenza e stabilità. Classificazione: ignifuga, autoestinguente e antibatterica. Finitura in legno rustico con due placche ornamentali che imitano il ferro in colore nero. Simile al legno al tatto, imitazione perfetta.*

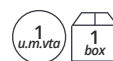

**Arbeitswagen aus Holz/Metall TOD**  
*Carrello barber in legno e metallo TOD*

REF.04698/54

**Kapitän Cook Capta-Tonne**  
*Bidone Captain Cook*

58 cm



88 cm

REF.06054

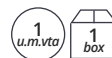
**Empfangstheke aus Holz und Metall mit Spiegeleffekt**  
**Bancone reception in legno e metallo a effetto specchio**

REF.03935

Mit Innenfächern aus Holz zur Aufbewahrung und Ablage  
Con scomparti interni in legno**Sofa mit 3 Sitzplätzen**  
**Divano attesa 3 posti**

REF.03950

» In Kunstleder  
» In similpelle



## Empfangstheke Eiche EARTH

### Bancone reception in rovere EARTH



- » Graphit-Laminat
- » Mit verstellbaren Einlegeböden und 1 Schublade

- » Laminato in grafite
- » Con ripiani regolabili e 1 cassetto

REF.04518/50

REF.04518/65

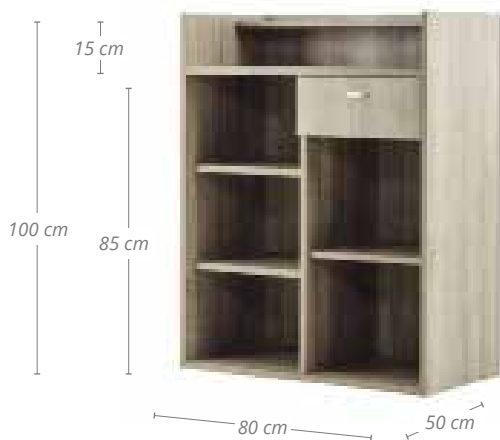

REF.04518/58

REF.04518/72

## Rolle 100 Schutzbezüge für stuhl

### Rotolo 100 protezioni per poltrone

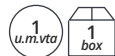

REF.07239



NEW

- » Halten Sie Keime von Ihrem Sitzplatz fern. Schnelle und einfache Desinfektion in wenigen Sekunden. Entfernen Sie danach den Bezug von dem Sitz und entsorgen Sie ihn. Passt für die meisten Stühle mit Lehne.
- » 65+16 x 150 cm / 0,025 mm

- » Mantieni i germi lontani. Disinfezione rapida e semplice: in pochi secondi rimuovi il rivestimento del sedile e lo smaltisci. Si adatta alla maggior parte delle poltrone con schienale.
- » 65+16 x 150 cm / 0,025 mm



**Handbrause mit Anschluss**  
**Doccia con supporto**

1 u.m.vta  
20 box

REF.03004



**Aufsatz Dusch-Set**  
**Set doccia adattabile**

1 u.m.vta  
10 box

REF.01960



**Einhandmischer für Waschbecken**  
**Miscelatore per lavatesta**

1 u.m.vta  
25 box

REF.02837



**Ionischer Duschkopf**  
**Soffione doccia ionico**

1 u.m.vta  
6 box

REF.03750



Spart Wasser  
 Bessere Wasserqualität

Risparmio idrico Migliore  
 qualità dell'acqua

**Organisator für hängende Handtücher**  
**Organizer per appendere asciugamani**

1 u.m.vta  
6 box

REF.04378

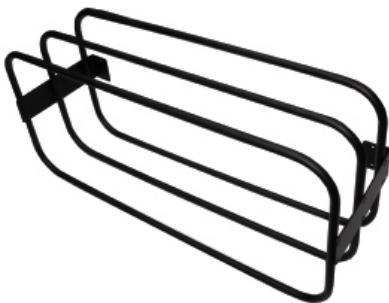

**Handtuchhalter**  
**Porta asciugamani**

1 u.m.vta  
4 box

REF.03159



» Mit Rädern  
 » Waschbarer  
 Container-Beutel  
 » Struktur aus  
 rostfreiem Stahl

» Con ruote  
 » Borsa contenitore  
 lavabile  
 » Struttura in acciaio  
 inox

08

# Zubehör

ACCESSORI

*Schutzpapier, Barbershop-Kleidung,  
Sprühflaschen, Koffer, Hygiene...*

*Carta collo, abbigliamento da barbiere,  
spruzzini, valigie, igiene...*



Nackpapier ist ein Klassiker im Friseurladen, um Juckreiz im Nacken und die Möglichkeit zu vermeiden, dass kleine Härchen in die Kleidung gelangen.

*La carta da collo è un classico dei saloni da barbiere per evitare prurito al collo e che i peli possano entrare nei vestiti.*

### Packung 5 Rollen Barber Line Nackpapier Confezione da 5 rotoli di carta da collo Barber Line



REF. 06596

REF. 06927

REF. 04651



- » 80 Anwendungen
- » Schwarz
- » Weißer Klebstoff

- » 80 servizi
- » Nero
- » Colla bianca



- » 80 Anwendungen
- » Schwarz
- » Weißer Klebstoff

- » 80 servizi
- » Nero
- » Colla bianca



- » 100 Anwendungen
- » Weiß
- » Weißer Klebstoff

- » 100 servizi
- » Bianca
- » Colla nera



Recycletes schwarzes Nackpapier, das nicht verblasst, ist chlorfrei und könnte daher für Lebensmittel verwendet werden (ISEGA-zertifiziert). Außerdem ist es FSC- (Material aus kontrollierten Wäldern) und PEFC- (nachhaltige Waldbewirtschaftung) zertifiziert.

*Carta da collo nera riciclata, non stinge, priva di cloro, potrebbe essere utilizzata anche per uso alimentare (certificata ISEGA). Possiede anche il certificato FSC (di materiale proveniente da foreste controllate) e PEFC (gestione forestale sostenibile).*

Packung 5 Rollen spezielles Friseur-Nackpapier, schwarzer Klebstoff. Vorgeschrittene Packungseinheit

*Confezione da 5 rotoli di carta speciale per collo da barbiere, colla nera.*

### Rolle Nackpapier Rotolo di carta da collo



REF. 00681

- » Elastisch
- » Perfekte und bequeme Passform
- » Hygienisch
- » Einwegpapier
- » 100 Anwendungen
- » 500 Anwendungen
- » Verhindert Juckreiz und Brennen am Hals

- » Elastica
- » Si adatta in maniera comoda e perfetta
- » Igienica
- » Usa e getta
- » 100 servizi
- » 500 servizi
- » Evita il prurito e il bruciore al collo



**Haar Pad**  
**Separatori di capelli**

- » Beutel mit 2 Pads
- » Klettverschluss

**REF.06440**

- » Beutel mit 2 Pads
- » Klettverschluss

**REF.06613**

- » Busta da 2 separatori
- » Velcro

- » Busta da 2 separatori
- » Velcro

**Halter für Nackenpapier**  
**Portarotoli per carta da collo**

- » Für Ref. 00681, 04651 und 06596
- » Per rif. 00681, 04651 e 06596

**REF. 00800****Halter für Nackenpapier**  
**Portarotoli per carta da collo**

- » Material: abs schwarz
- » Kann an der wand aufgehängt werden
- » Materiale: abs nero
- » Può essere appeso alla parete

**REF. 06803****NEW****Augenschutz Barbiersalon**  
**Protezione per occhi**

- » Beutel mit 50 Augenschützern
- » Busta da 50 protezioni per gli occhi

**REF. 06315****Gehörschutz 50 Stück**  
**Protezione per le orecchie 50 unità**

- » Abmessungen: 2\*4,5 cm
- » Gewicht: 0,40 Gramm
- » Plastisches Material

**REF. 07008**

- » Dimensioni: 2\*4.5 cm
- » Peso: 0,40 grammi
- » Materiale plastico



## Nackenumhang Silikon

### Mantella in silicone

**EUROsil**  
PROFESIONALE



1  
u.m.vta

10  
box

REF. 07006

40x40 cm



## BARBER LINE Schneideumhang

### Mantella da taglio BARBER LINE



1  
u.m.vta

40  
box

REF. 06988

- » Pongee-Polyester
- » Wasserabweisend
- » Gewicht 150 gr
- » Knopf-Verschluss

- » Poliester Pongee
- » Idrorepellente
- » Peso 150 g
- » Chiusura a bottone

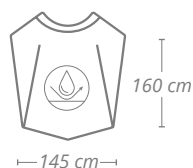
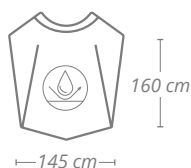

145 cm



1  
u.m.vta

40  
box

REF. 06989

## EUROSTIL- Schneideumhang

### Mantella da taglio EUROSTIL

- » Pongee-Polyester
- » Wasserabweisend
- » Gewicht 150 g
- » Knopf-Verschluss

- » Poliester Pongee
- » Idrorepellente
- » Peso 150 g
- » Chiusura a bottone

**EUROsil**  
PROFESIONALE



### Gestreifter Umhang Barberbole Mantella a righe barber



- » Pongee-Polyester
- » Wasserabweisend
- » Gewicht: 150 Gramm
- » Verschluss: Haken



REF.06991

- » Poliester Pongee
- » Idrorepellente
- » Peso: 150 grammi
- » Chiusura: ganci



### Schwarz-weiß gestreifter Umhang Mantella a righe bianche nere



- » Pongee-Polyester
- » Wasserabweisend
- » Gewicht: 150 Gramm
- » Knopf-Verschluss



REF.06992

- » Poliester Pongee
- » Idrorepellente
- » Peso: 150 grammi
- » Chiusura a bottone



### Gestreifter Umhang Totenkopf Mantella a righe con logo



- » Pongee-Polyester
- » Wasserabweisend
- » Gewicht: 150 Gramm
- » Verschluss: Haken

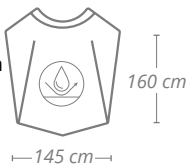

REF.06993

- » Poliester Pongee
- » Idrorepellente
- » Peso: 150 grammi
- » Chiusura: ganci



### Umhang Utensilien Mantella fantasia barber



- » Pongee-Polyester
- » Wasserabweisend
- » Gewicht: 150 Gramm
- » Knopf-Verschluss

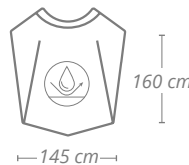

REF.06995

- » Poliester Pongee
- » Idrorepellente
- » Peso: 150 grammi
- » Chiusura a bottone



### Umhang Barber Shop Mantella Barber Shop

- » Pongee-Polyester
- » Wasserabweisend
- » Gewicht: 150 Gramm
- » Knopf-Verschluss

- » Poliestere Pongee
- » Idrorepellente
- » Peso: 150 grammi
- » Chiusura a bottone

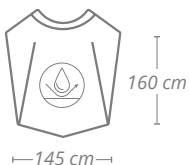

REF.06997



### EUROSTIL-Schneideumhang Mantella da taglio EUROSTIL

- » Modell Totenkopf
- » 100% Nylon
- » Knopf-Verschluss

- » Modello con teschio
- » 100% nylon
- » Chiusura a bottone



REF.04577



### Beutel 30 Capes schwarz Confezione da 30 mantelline nere

- » Einmaligen Gebrauch
- » Monouso

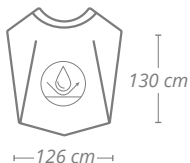

REF. 07243



NEW

### Kunststoffumhang Färben Mantella in plastica per tintura

- » Groß
- » Klettverschluss

- » Grande
- » Velcro



REF. 01174





### Schürze Jeansstoff mit Taschen Grembiule di jeans con tasche

» Gewicht: 200 Gramm  
» Peso: 200 grammi

REF. 07010

» Gewicht: 200 gramm  
» Schwarz mit details aus kunstleder

REF. 07057

» Peso: 200 grammi  
» Nero con dettagli in similpelle.

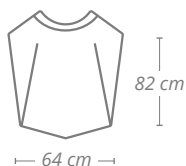

NEW

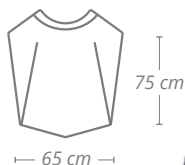

NEW



### Blaue Jeans Schürze BARBER LINE Grembiule in jeans blu BARBER LINE

» Gewicht: 200 Gramm  
» Mit dem Logo der Barber Line gekennzeichnet

REF. 07058

### BARBER LINE Schürze Grembiule BARBER LINE

» 3 Taschen, 1 obere, 2 untere  
» 6 Unterteilunge, 1 obere und 5 untere

REF. 06182

» Peso: 200 grammi  
» Contrassegnato con il logo Barber Line

» 3 tasche, 1 superiore, 2 inferiori



### CAPTAIN COOK Schneideumhang

#### Mantella da taglio CAPTAIN COOK

1  
u.m.vta

12  
box

- » 100% Nylon
- » 100% Nylon

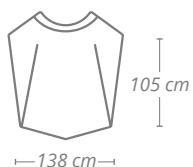

REF.04975/50

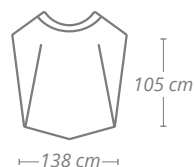

REF.04975/58



### CAPTAIN COOK Schürze

#### Grembiule CAPTAIN COOK

1  
u.m.vta

12  
box

- » 3 Taschen, 1 obere, 2 untere
- » 6 Unterteilungen, 1 obere und 5 untere

» 3 tasche, 1 superiore, 2 inferiori

REF. 06181

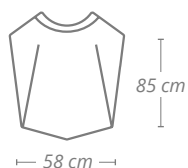

**Gestreifter Barbier Umhang**  
*Mantella da barbiere a righe*

1 u.m.vta 40 box

**MOD. 21800976**

- » 100% feiner Polyester
- » Mit Schnappverschluss
- » Leicht zu bügeln
- » Ohne Dekor und antistatisch
- » Einheitsgröße

- » 100% poliestere fine
- » Chiusura con bottone a pressione
- » Facile da stirare
- » Antistatico e non scolora.
- » Taglia unica

 131/132 cm  
 143/144 cm

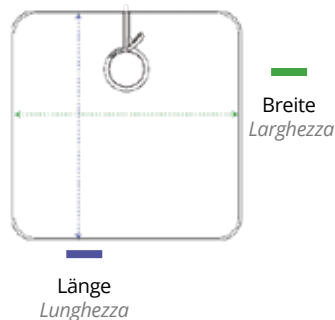
**REF. 06351**

**Berberpole Umhang**  
*Mantella a righe da barbiere*

1 u.m.vta 40 box

**MOD. 21800974**

- » 100% feiner Polyester
- » Mit Druckknöpfen
- » Leicht zu bügeln
- » Ohne Dekor und antistatisch
- » Einheitsgröße

- » 100% poliestere fine
- » Chiusura con bottone a pressione
- » Facile da stirare
- » Antistatico e non scolora.
- » Taglia unica

 131/132 cm  
 143/144 cm

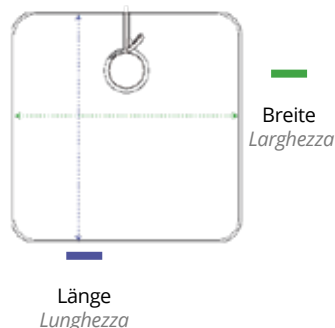
**REF.06353**

**Grauer Tarnumhang**  
*Mantella mimetica grigia*

1 u.m.vta 40 box

**MOD. 21800975**

- » 100% feiner Polyester
- » Mit Druckknopf
- » Leicht zu bügeln
- » Ohne Dekor und antistatisch
- » Einheitsgröße

- » 100% poliestere fine
- » Chiusura con bottone a pressione
- » Facile da stirare
- » Antistatico e non scolora.
- » Taglia unica

 131/132 cm  
 143/144 cm

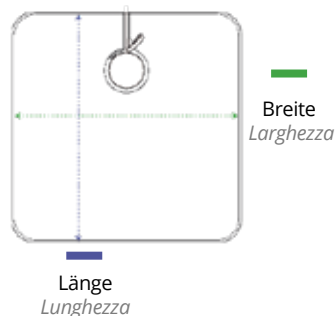
**REF.06352**

### Kasack mit Mao-Kragen Camicia con colletto coreano

MOD. 51805305

Kasack mit Mao-Kragen und YKK-Reißverschluss. Taschen mit Lätzchen leicht zu bügeln. Ohne Dekor und antistatisch. 100% feiner Polyester.

*Camicia con colletto alla coreano con cerniera YKK. Copritasche anti-peluria. Facile da stirare. Antistatica e non scolora. 100% poliestere fine*



Länge  
Lunghezza

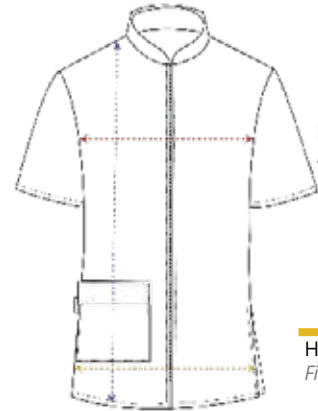

Brustumfang  
Petto

Hüfte  
Fianchi

S

106-110 cm  
110-114 cm  
72-74 cm

REF.06357/50/1

M

112-116 cm  
114-118 cm  
73-75 cm

REF.06357/50/2

L

118-122 cm  
120-124 cm  
74-76 cm

REF.06357/50/3

XL

130-134 cm  
132-136 cm  
75-77 cm

REF.06357/50/4

MOD. 51805305



Länge  
Lunghezza

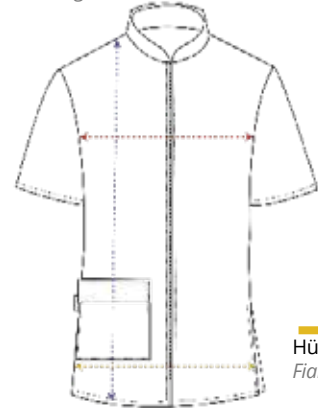

Brustumfang  
Petto

Hüfte  
Fianchi

S

106-110 cm  
110-114 cm  
72-74 cm

REF.06357/58/1

M

112-116 cm  
114-118 cm  
73-75 cm

REF.06357/58/2

L

118-122 cm  
120-124 cm  
74-76 cm

REF.06357/58/3

XL

130-134 cm  
132-136 cm  
75-77 cm

REF.06357/58/4

**Retro Jeans Schürze**  
**Grembiule retró in jeans**
**MOD. 31803155**

Elastische Retro Schürze aus Jeansstoff mit Details aus braunem Lackleder. Zentrale Tasche mit Applikation für Utensilien. Gekreuzte verstellbare Clips auf der Rückseite. Zentraler Schnitt. Einheitsgröße für alle

- » 60% Polyester
- » 37% Baumwolle
- » 3% elastisch

» *Grembiule retró in jeans elasticizzato con dettagli in similpelle marrone. Tasca centrale con tasca per utensili. Clip di regolazione incrociate sul retro. Taglio centrale. Taglia unica*

- » 60% poliestere
- » 37% cotone
- » 3% elastico



27/28 cm

69/70 cm

81/82 cm

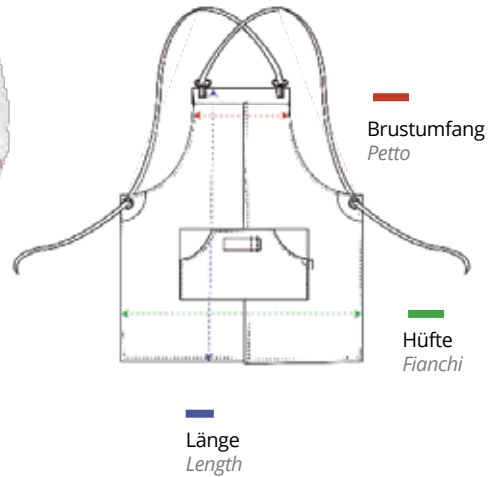
**REF.06355**

**Jeans Latzschürze**  
**Grembiule in jeans**
**MOD. 31603125**

Latzschürze aus elastischen Jeansstoff. Verstellung mit Gurt und Schlaufenverschluss. Mit 4 Taschen (mittlere Tasche in 2 + 2 kleine Unterteilungen). Einheitsgröße

- » 60% Polyester
- » 37% Baumwolle
- » 3% elastisch

» *Grembiule in jeans elasticizzato. Regolazione con cintura e chiusura con laccio. Con 4 tasche (tasca centrale divisa in 2 + 2 piccole). Taglia unica*

- » 60% poliestere
- » 37% cotone
- » 3% elastico



25/26 cm

82/83 cm

81,50/82,50 cm

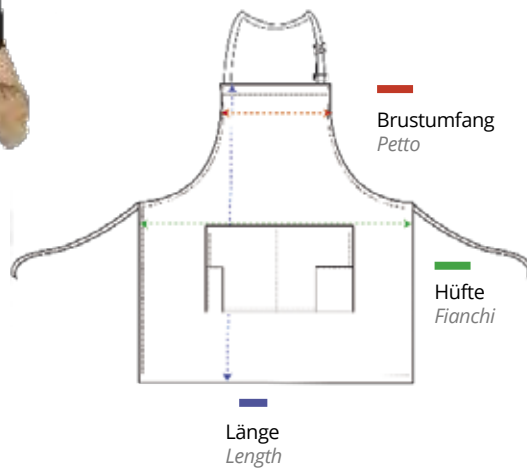
**REF. 06310/50**



## Schürze aus Kunstleder Grembiule in similpelle

MOD. 31803151

Schürze aus glattem Kunstleder.  
Keine Taschen. Wasserdicht. Mit  
Nackenverstellung

» Kunstleder

*Grembiule in similpelle. Senza  
tasche. Impermeabile. Con  
regolazione sul collo*

» Similpelle



28/29 cm  
66/67 cm  
81,50/82,50 cm

REF.06350

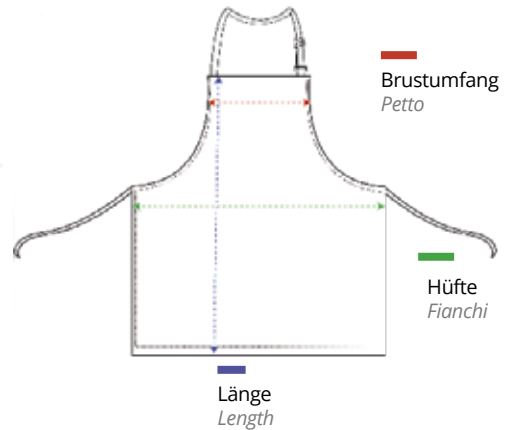

## Unisex-Hosen Pantaloni unisex

MOD. 41300904

Hose aus feinem Polyester mit 3  
Taschen. In der Taille mit einem  
Kordelzug verstellbar. Leicht zu bügeln.  
Ohne Dekor und antistatisch.

» 100% feiner Polyester

*Pantaloni in poliestere fine con 3 tasche.  
Vita regolabile con laccio. Facile da  
stirare. Antistatico e non scolora.*

» 100% poliestere fine

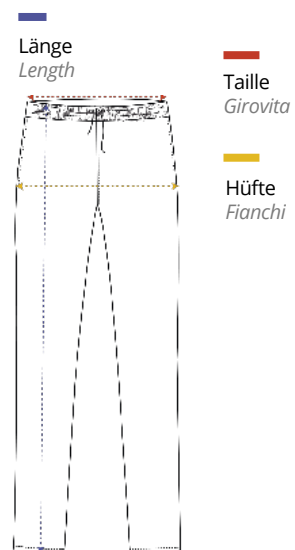

S

96-96 cm  
92-96 cm  
99-101 cm

REF.06356/1

M

102-106 cm  
104-108 cm  
107-109 cm

REF.06356/2

L

110-114 cm  
110-114 cm  
107-109 cm

REF.06356/3

XL

112-116 cm  
114-118 cm  
108-110 cm

REF.06356/4

**Sprühflasche Barbier farbig  
Spruzzino Barber Line**

- » 6 Bernsteinfarben + 3 durchsichtig + 3 grau
- » Material: Kunststoff
- » Gewicht: 76 Gramm

500 ml

REF.06998

- » Materiale: plastica
- » Peso: 76 grammi



25 cm

6,5 cm

**Sprühflasche Barbier farbig  
Spruzzino Barber Line**

- » 6 Bernsteinfarben + 3 durchsichtig + 3 grau
- » Material: Kunststoff
- » Gewicht: 86 Gramm

650 ml

REF.06999

- » Materiale: plastica
- » Peso: 86 grammi



24,5 cm

7,5 cm

**Sprühflasche Parfüm Barbier farbig  
Spruzzino Barber Line**

- » 6 Bernsteinfarben + 3 durchsichtig + 3 grau
- » Material: Kunststoff
- » Gewicht: 76 Gramm

280 ml

REF.07000

- » Materiale: plastica
- » Peso: 76 grammi

**Sprühflasche Barbier Totenkopf  
Spruzzino Barber Line teschio**

- » Mit japanischem Sprühkopf
- » Material: Kunststoff
- » Gewicht: 101 Gramm
- » 6 Bernsteinfarben + 6 schwarz

500 ml

REF.07002

- » Materiale: plastica
- » Peso: 101 grammi



**EUROSTIL-Sprühflasche**  
**Spray EUROSTIL**

30 ml

REF.07001

- » Klare Flasche mit schwarzem Sprühkopf
- » Material: Kunststoff
- » Gewicht 45 Gramm

- » *Bottiglia trasparente con sprayer nero*
- » *Materiale: plastica*
- » *Peso 45 g*

**Zerstäuber**  
**Atomizzatore**

**Kontinuierliches Spray:** versprüht das Wasser mit nur einem Knopfdruck fein und gleichmäßig unter dem gleichen Druck von Beginn an bis zum letzten Tropfen.

**360°:** kann aus allen Winkeln verwendet werden, sogar mit der Düse nach unten. Feine Zerstäubung vom Typ Nebel, die das Wasser gleichmäßig auf das ganze Haar verteilt.

**Fassungsvermögen:** 300 ml nachfüllbar.

**Fixes Druckvolumen:** 1,25 cc kontinuierlich

**Verhindert das Ermüden** der Hand im Vergleich mit den Standard-Sprays. Ohne gasförmige Schadstoffe.

**Keine umweltschädlichen Gase**

**Spray continu:** avec une seule pression, il pulvérise l'eau de manière fine et uniforme, avec la même pression du début jusqu'à la dernière goutte.

**360° :** il peut être utilisé depuis tous les angles, y compris la tête en bas. Pulvérisation fine, type brume, qui distribue l'eau de manière uniforme sur tous les cheveux

**Capacité :** 300 ml rechargeable.

**Volume fixe de pression :** 1,25 cc continu.

**Évite la fatigue de la main** par rapport à d'autres spray standards.

**Sans gaz contaminant.**

300 ml

REF.04731

NEW

300 ml

REF.07247



300 ml

REF.04978



300 ml

REF.06243





**Zerstäuber Barber Line**  
**Spruzzini Barber Line**» Aluminium  
» Alluminio

280 ml

REF.04837

» Talkum  
» Talco

180 ml

REF.06118

**Klassischer Talkumpuder-Zerstäuber BARBER LINE**  
**Classico per talco BARBER LINE**» Talkum  
» Talco

180 ml

REF.06179

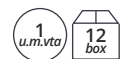

180 ml

REF.06178



**Aluminium-zerstäuber**  
**Spruzzino in alluminio**

- » Lackiertes Interieur
- » Interno laccato

280 ml

REF.01384

- » Neutral
- » Neutro



280 ml

REF.01384/02

23,5 cm



**Aussteller von 30 Aluminiumzerstäubern**  
**Espositore per 30 spruzzini in alluminio**



280 ml

REF.01465

280 ml

REF.01465/02



- » Eurostil
- » Eurostil

- » Neutral
- » Neutro

**Plastik-Zerstäuber**  
**Spruzzino in plastica**

- » Mit Anhänger
- » Con gancio



130 ml

REF.03401

- » japanisch schwarz
- » Nero giapponese



300 ml

REF.04377



### Barbier-Rucksack Zaino - Valigia per barbieri



REF.06797

- » 4 große Fächer mit Reißverschluss
- » Es hat mehr spezielle Innenfächer für Maschinen und Utensilien
- » Material: Polyester-ähnlich Haut
- » Verschlüsse an den Griffen mit Clip

- » 4 ampi scomparti con chiusura a zip
- » Dispone di scomparti interni per macchine e utensili
- » Materiale: similpelle in poliester
- » Chiusura sui manici con clip



### Schwarzer Barbier-Koffer Valigetta nera da barbieri



REF.06438



### Kunstleder-Rollkoffer für Friseurbedarf (leer) Valigia trolley da parrucchiere (vuota)

Alle Koffer werden leer verkauft  
Tutte le valigie vengono vendute vuote



REF.04308

REF.06136



- » 3 große Fächer mit 2 Ablagen oben mit Aussparungen für Utensilien
- » 4 Räder für bequemen und einfachen Transport
- » Mit abnehmbaren Rädern



- » 3 ampi scomparti con 2 ripiani nella parte superiore con rientranze per riporre gli utensili
- » 4 ruote per spostarlo in maniera comoda e facile
- » Con ruote smontabili

### 4-Teiliger Rollkoffer Valigia trolley a 4 blocchi



REF.04943

Doppelterr Koffer mit Rollen. Der obere Kofferteil kann in einen Tragekofferrumgewandelt werden, der mit einem Schulterriemen ausgestattet ist. Er verfügt über zwei seitlich verschiebbare Innenfächer. Der Innenraum ist breit und der untere Teil ist abnehmbar und kunststoffbeschichtet, so dass der Koffer leicht zu reinigen ist. Auch auf der Rückseite hat er eine Außentasche.

Das untere Gehäuse mit Rädern hat eine kunststoffbeschichtete Innenseite und ist zur einfachen Reinigung abnehmbar. Es wird mit einem Bürstenhalter Abteil geliefert, der mittels eines Klettverschlusses befestigt wird. Dieses Abteil ist zwischen Ober- und Unterkoffer austauschbar. Er verfügt über 8 Schubladen zum Aufbewahren und Sortieren kleiner Produkte und eine Tasche auf jeder Seite. Jedes Kofferteil hat 4 herausnehmbare Schubladen integriert, die in einem Stück zusammengefügt sind

*Valigia doppia in nylon con ruote. La valigia può essere convertita in un bagaglio a mano che viene fornito con una tracolla. Ha due ripiani interni che possono essere spostati sui lati. L'interno è spazioso e la parte inferiore è rimovibile e plastificata per facilitare la pulizia della valigia. Anche nella parte posteriore ha una tasca esterna.*

*La valigia inferiore, su ruote, ha una parte interna plastificata ed è rimovibile per rendere più facile la pulizia. Viene insieme con una coperta portaspaiole fissata con velcro. Questa coperta può essere scambiata tra la valigia superiore e quella inferiore. Dispone di 8 cassetti per riporre e separare piccoli prodotti e una tasca su ogni lato. Ogni colonna integra 4 cassetti estraibili uniti in un unico blocco.*



### Friseurtasche mit Rädern Trolley da parrucchiere



» Mit einer Metallstruktur, die es ermöglicht, den Koffer als Sitz zu verwenden

REF.04402/50

» Con struttura in metallo che permette di utilizzare la valigia come seduta



**Inklusive  
Toilettentasche (leer)  
Beauty case (vuoto)  
incluso**



### Rollkoffer Valigia trolley



REF.03814/50



### Friseirkoffer aus Aluminium Valigia da parrucchiere in alluminio



REF.04307

» (Leer)  
» (Vuota)



**Packung mit 75 CELLULOSE Handtüchern**  
**Confezione da 75 salviette CELLULOSA**

- » Spezielle Maniküre
- » Speciale per

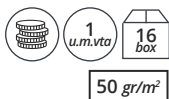

REF. 04204

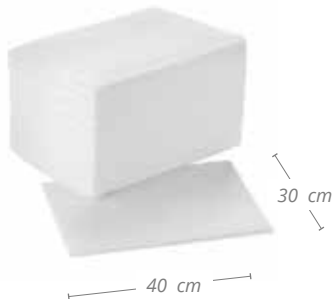
**Packung mit 25 SPUNLACE Handtüchern**  
**Confezione da 25 salviette SPUNLACE**

- » Gefaltet auf 20 x 20 cm
- » 50% Polyester / 50% Viskose
- » Piegata 20 x 20 cm
- » 50% poliestere / 50% viscosa



REF. 04916



REF. 03221

**Packung mit 90 CELLULOSE Handtüchern**  
**Confezione da 90 salviette CELLULOSA**

REF. 04076

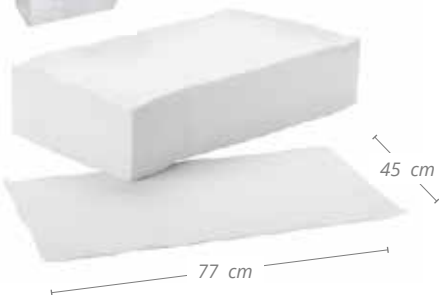
**Packung mit 100 SPUNLACE Handtüchern**  
**Confezione da 100 salviette SPUNLACE**

- » Superabsorbierend
- » Ultra assorbenti

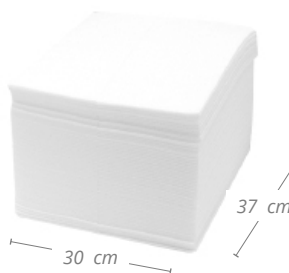

REF. 03283

**Beutel 25 Handtücher SPUNLACE**  
**Confezione da 25 salviette SPUNLACE**

- » Superabsorbierend
- » Ultra assorbenti



REF. 07233

NEW

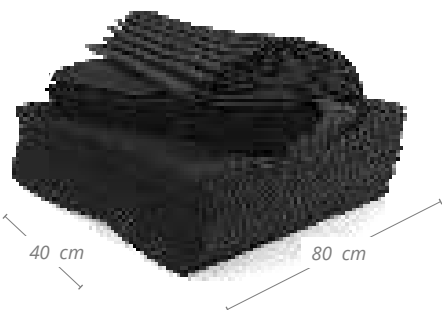
**35 SPUNLACE-Handtücher**  
**Confezione da 35 salviette PUNLACE**

- » Superabsorbierend
- » Gefaltete Handtücher
- » Ultra assorbenti
- » Salviette piegate



REF. 04509

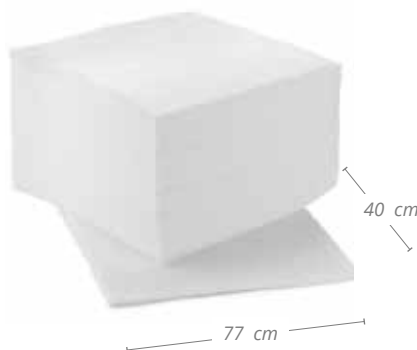

**Handtuch aus 100% Baumwolle**  
**Asciugamano 100% cotone**



REF. 02947/50

» Bleichmittelbeständig  
 » Resistente alla candeggina

REF. 04953/50

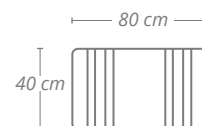
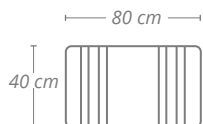

REF. 02901/50

» Bleichmittelbeständig  
 » Resistente alla  
 candeggina

REF. 06829/50

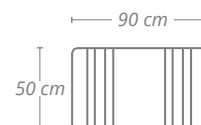
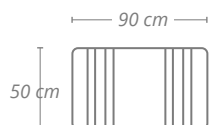

**Barbier-Handtuch aus 100% Baumwolle**  
**Asciugamano da barbiere 100% cotone**



380 gr

REF. 06413/50

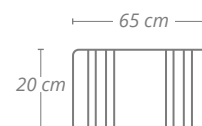

## 100 HANDSCHUHE PE zum einmaligen Gebrauch und für eine astreine Hygiene

### 100 Guanti pe monouso



REF. 07257

- » Beidhändig
- » Einheitsgröße
- » Multifunktional

- » *Ambidestro consente a ciascun guanto di essere usato per qualsiasi mano*
- » *Taglia unica*
- » *Multiuso*



NEW



## 100 transparente Polyethylenhandschuhe

### 100 Guanti polietilene trasparenti



REF. 07804

- » 100% reines Polyethylen HDPE 0,7+/-2%/pc
- » Hypoallergen, undurchlässig, Einheitsgröße
- » EPI Handelsklasse 1, angefertigt und gekennzeichnet CE
- » Kompatibel mit Lebensmittelgebrauch 2011/10/CE
- » 30 cm. hoch x 25 cm. Breit - Finger 15 cm breit Handgelenk

- » *Polietilene hdpe 100% 0,7 +/- 2% g / pz*
- » *Anallergici, impermeabile, taglia unica,*
- » *DPI di categoria 1, prodotti e marcati CE,*
- » *Compatibile con uso alimentare 2011/10 / CE*
- » *30 Cm altezza x 25 cm larghezza x 15 larghezza polso 15*



NEW



## Beutel mit 100 Einweghandschuhen

### Confezione da 100 guanti monouso



REF. 07304



NEW



### Schachtel 20 schwarze Latex-Handschuhe

Confezione da 20 guanti neri in latex

LATEX / LATEX  
AQL 1,5



OHNE Pulver  
SENZA polvere

S/M

REF. 02832

M

REF. 02833

L

REF. 02834



Erfüllt alle Vorschriften / Rispetta le normative: EN 374-1, EN 374-2, EN 374-3, CE

### Schachtel 100 schwarze Nitril-Handschuhe

Confezione da 100 guanti in nitrile

NITRILE / NITRILE  
AQL 1,5



OHNE Pulver  
SENZA polvere

S/M

REF. 06686

S/M

REF. 06687

S/M

REF. 06688



Cumple normativa / Rispetta le normative: EN 374-1, EN 374-2, EN 374-3, CE

### Plexiglas Scherenhalter

Espositore per forbici

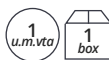

REF.04074



### Behälter für Scheren

Contentitore per forbici

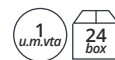

REF.04740



### Visitenkartenbox aus Aluminium

Porta biglietti da visita in alluminio

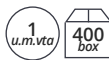

REF.02470



### Taillengürtel für Utensilien

Cintura portastrumenti



REF.04310



Alle Friseur Taschen werden  
leer verkauft

Tutti i portautensili vengono  
venduti vuoti



## Etui für Utensilien Portastrumenti

- » Mit 5 Unterteilungen (leer)
- » Con 5 combinabili (vuoto)



REF.03622



REF.03620



REF.03621



## CAPTAIN COOK CAPTAIN COOK

- » Etui für Utensilien
- » Astuccio per attrezzi



REF.04979

- » Schwarze Mütze
- » Cappellino nero



REF.07430



NEW

- » Schwarzes T-Shirt
- » Maglietta nera



S

REF.04957/4

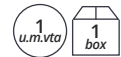

M

REF.04957/1

L

REF.04957/2

XL

REF.04957/3

## Hydroalkoholische Lösung Soluzione idroalcolica



 <b>NEW</b> 100 ml REF.07176	 <b>NEW</b> 500 ml REF.07177	 <b>NEW</b> 1 L REF.07260	 <b>NEW</b> 1 L REF.07214
1 u.m.vta 63 box	1 u.m.vta 24 box	1 u.m.vta 12 box	1 u.m.vta 12 box

» Mit dosierpumpe  
» Con pompa dosatrice

## Hydroalkoholisches Gel mit Aloe Vera Gel idroalcolico con Aloe Vera

**NEW**

100 ml

REF.07246

1 u.m.vta  
40 box



## Hydroalkoholisches Gel Gel idroalcolico

**NEW**

500 ml

REF.07216

1 u.m.vta  
12 box



## Alkohol 96° Alcol 96°

**NEW**

1 L

REF.07218

1 u.m.vta  
12 box



**Artikel, die ausschließlich in Spanien verkauft werden**  
*Articoli in vendita esclusiva IN SPAGNA*

### Antiseptikum Daromix GH Antisettico Daromix GH



500 ml

REF.06200



- » AEMPS-Registrierungsnummer: 905-DE5
- » Wasser-alkoholisches Antiseptikum zur hygienischen Händedesinfektion durch Reibung
- » Wissenschaftlich garantierte Wirksamkeit
- » Breites Biozid Spektrum ab 30 sec
- » Hypoallergene Formel
- » Bewahrt die Hautfeuchtigkeit
- » Keine Hautreizung
- » Schnell trocknend
- » Wirksam als: Bakterizid, Levurozid, Viruzid und Mikrobakterizid

- » Numero di registrazione AEMPS: 905-DE5
- » Antisettico idroalcolico per la disinfezione igienica delle mani per sfregamento
- » Efficacia scientificamente garantita
- » Biocida ad ampio spettro a partire da 30 sec
- » Formula ipoallergenica
- » Preserva l'idratazione della pelle
- » Non irritante per la pelle
- » Asciuga velocemente
- » Efficace come: battericida, lieviticida, viricida e microbattericida

### Desinfektionsmittel Limoseptol Disinfettante Limoseptol



50 ml

REF. 06151

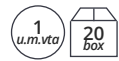

1 L

REF.06150



- » AEMPS-Registrierungsnummer: 47-DE5
- » Hochwertiges Produkt, das ausschließlich für Hygiene, Reinigung und Desinfektion entwickelt wurde, für professionelle Utensilien eines Salons.
- » Waschmittelwirkung - breites Spektrum
- » Biologisch abbaubar - phosphatfrei und FORMOLFREI
- » Keimtötende und desinfizierende Wirkung gegen: Bakterien, Hefen und Pilze
- » Mischverhältnis
- » 100 ml Produkt = 10 Liter Wasser

- » Numero di registrazione AEMPS: 47-DE5
- » Prodotto di alto livello sviluppato esclusivamente per l'igiene, la pulizia e la disinfezione degli utensili professionali nei centri estetici
- » Azione detergente - Ampio spettro
- » Biodegradabile - Senza fosfati e senza FORMOLO
- » Efficacia germicida e DISINFETTANTE contro: batteri, lieviti e funghi
- » Dose da mescolare
- » 100 ml di prodotto = 10 litri di acqua

## Flasche speziell für hydroalkoholische Lösung und hydroalkoholische Lösung Speciale per gel e soluzione idroalcolica



300 ml

REF.07279



NEW

» Mit wandhalterung  
» Con supporto a parete



300 ml

REF.07278



NEW

## Große Sterilisor-Flasche

Contentore in vetro per la disinfezione degli attrezzi



1 L

REF.06141

» Ideal zum sterilisieren kleiner Utensilien  
» Material: Glas

» Ideale per sterilizzare piccoli utensili  
» Materiale: vetro



**Spiegel  
Specchi**» Schwarzer Spiegel  
» Specchio nero» T.V.-Spiegel  
» Specchio TV

REF. 02591/50



REF. 00254/50

» Professioneller Spiegel mit schwarzen  
Griffen  
» Specchio professionale con maniglie nere» Professioneller Doppelspiegel  
» Specchio professionale doppio

REF. 01955/50

REF. 04379

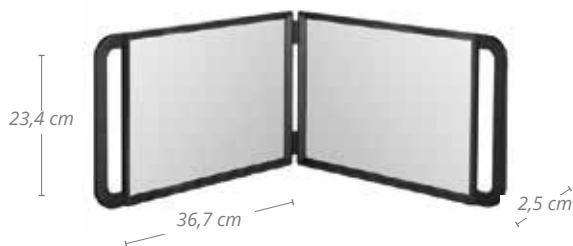
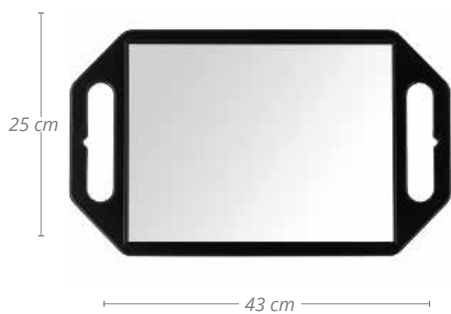
**Spiegel mit schwarzem Griff aus EVA-Schaumstoff**  
Specchio in schiuma EVA con manico nero

REF. 02170



## Anti-fog-schutzbrille Occhiali protettivi antivapore



REF.07256

- » Schutz zur Prävention gegen Infektionen: schützt wirksam gegen Spritzer, Kies usw.
- » Verwendungsort: jeder Ort, an dem Augenschutz erforderlich ist
- » Innovatives, komfortables Design. Passt sich perfekt an jede Kopfform und Kopfgröße an
- » Kann gleichzeitig mit Ihrer normalen Brille verwendet werden
- » EG-Zertifizierung
- » Material: Kunststoff

- » *Protezione per prevenire le infezioni: proteggere efficacemente da schizzi, schegge, ecc.*
- » *Luogo di utilizzo: qualsiasi luogo in cui è richiesta la protezione degli occhi*
- » *Confortevole design innovativo. Si adattano perfettamente a qualsiasi forma e dimensione della testa*
- » *Possono essere utilizzati contemporaneamente agli occhiali da vista.*
- » *Certificato CE*
- » *Materiale: plastica*



## Desinfizierende Fussmatte Tappetino disinfettante per scarpe



REF.07234

Extra flache Fußmatte mit nur 1 cm Höhe zur Verhinderung von Ausrutschen, hergestellt aus Polypropylen auf einer Gummiunterlage, enthält ionisiertes Aluminium. Maße: 60 cm Breite x 40 cm Länge x 1 cm Höhe/Dicke.

Verwendung: die Matte auf eine ebene, waagerechte Fläche legen, etwa 700 ml Desinfektionsflüssigkeit auf die Ablage auftragen. Es ist ratsam, einen Fußabtreter auf die Ablage zu legen, um die Schuhe des Kunden zu trocknen.

*Tappetino extra piatto alto solo 1 cm per evitare inciampi, realizzato in polipropilene su base in gomma e contenitore in alluminio ionizzato. Misure: 60 cm di larghezza x 40 cm di lunghezza x 1 cm di altezza/spessore.*

*Modo d'uso: posizionare il tappetino su una superficie piana e livellata, applicare circa 700ml di liquido disinfettante sul vassoio. Si consiglia di posizionare un tappetino accanto al vassoio per asciugare le scarpe del cliente.*

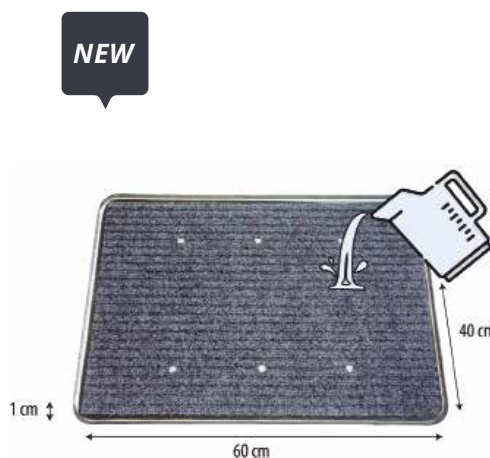

## Beutel 100 Schuhüberzüge Copriscarpe da 100 unità



REF.07211

- » Einweg
- » Plastik
- » Monouso
- » Plastico



**Automatischer wandgelspender mit tablet**  
*Erogatore automatico di gel da parete con vassoio*

NEW

**Automatischer tisch-gel-spender**  
*Erogatore automatico di gel da parete*

NEW

**Automatischer gelspender mit sockel**  
*Erogatore di gel automatico con treppiede*

NEW

**Manueller wandspender**  
*Erogatore manuale da parete*

NEW



- » Werkstoff: ABS
- » Pumpentyp: Gel-Tropf
- » Stromversorgung: 4 Batterien (LR14 Größe C)
- » Erkennungsabstand: 6-10 cm.
- » Abgabemenge e: 0,8-1 ml einstellbar

- » Materiale: ABS
- » Tipo di pompa: erogazione di gocce di gel
- » Alimentazione elettrica: 4 batterie (LR14 tipo C)
- » Distanza di rilevamento: 6-10 cm.
- » Uscita: 0,8-1 ml regolabile

## Besen aus Gummi

### Scope di gomma

4  
u.m.vta

16  
box

REF.01223

- » Mit Borsten
- » Con linguetta



5  
u.m.vta

20  
box

REF. 01285/50



- » Die leicht zu reinigenden und langlebigen Borsten sind so konstruiert, dass sie den Staub mitreißen, ohne ihn anzuheben, was sie ideal für Allergiker macht, da sie eine saubere Umgebung begünstigen.

5  
u.m.vta

20  
box

REF.02420

- » *Facile da pulire e di lunga durata, l'efficienza del design dei suoi denti riesce a trascinare la polvere senza sollevarla, rendendola ideale per chi soffre di allergie in quanto aiuta a mantenere i locali puliti*



## Besenstiel

### Manico di scopa

- » Leicht zu reinigen und langlebig
- » Kunststoffhalter
- » Ideal für alle Arten von Bodenbelägen, insbesondere Parkett

12  
u.m.vta

12  
box

REF.01131

- » Extra ausziehbar
- » Telescopico

10  
u.m.vta

10  
box

REF.01365

- » *Facile da pulire e di lunga durata*
- » *Gancio in plastica*
- » *Ideale per tutti i tipi di pavimento, in particolare il parquet*





09

# Ausbildung

## FORMAZIONE

*Männliche Schaufensterpuppen,  
Halter, Stative...*

*Teste studio uomo,  
Supporti e Treppiedi*



# BERGMANN

## HAIR AND MORE...

- » Natürliche Implantationen
- » Schneiden, Bleichen, Färben, Kämmen und Trocknen

- » *Impianto naturale*
- » *Tagliare, decolorare, tingere, acconciature e asciugatura*



20 cm  
aprox.

**Boy**  
REF. 06341

## EURO *stil*

PROFESSIONAL

### Männliche Schaufensterpuppe, 100% Teste studio uomo, CAPELLI 100% NATURALI

Halter nicht inbegriffen  
Supporto non incluso



- » 42 Implantate pro cm<sup>2</sup>
- » 7-8 Haare pro Implantat
- » Ca. 320 Haare pro cm<sup>2</sup>
- » Zum Schneiden, Bleichen, Färben, Stylen, Trocknen und Glätten
- » Maximale Temperatur 180°C

- » 42 impianti per cm<sup>2</sup>
- » 7-8 capelli per impianto
- » 320 capelli circa per cm<sup>2</sup>
- » *Per tagliare, decolorare, tingere, acconciature, asciugatura e piastra*
- » *Temperatura massima 180°C*

### Castanie · Castano

- » Natürliches Implantat 45°

REF. 02495

- » *Impianto naturale 45°*

### Kastanie mit Bart · Castano con barba

- » Natürliches Implantat 45°.
- » Auch zum Bartschneiden

REF. 02169

- » *Impianto naturale 45°*
- » *Anche per taglio della barba*



15 - 18 cm

Ø 58 cm



15 - 18 cm

Ø 58 cm

**Männliche Schaufensterpuppe, 100%**  
**Testa di manichino uomo, CAPELLI 100% NATURALI**



- » 42 Implantate pro cm2
- » 7-8 Haare pro Implantat
- » Ca. 320 Haare pro cm2
- » Zum Schneiden, Bleichen, Färben, Stylen, Trocknen und Glätten
- » Maximale Temperatur 180°C

- » 42 impianti per cm2
- » 7-8 capelli per impianto
- » 320 capelli circa per cm2
- » Per tagliare, decolorare, tingere, acconciare, asciugatura e piastra
- » Temperatura massima 180°C

**Hellbraun · Castano chiaro**

- » Natürliches Implantat 45°
- » Impianto naturale 45°

**Joe**  
REF. 06147

- » Klassische 90°-Implantation
- » Impianto naturale 45°

**Joe**  
REF. 04909



15 - 18 cm

Ø 54 cm



15 - 18 cm

Ø 54 cm



**Hellbraun mit Bart · Castano chiaro con barba**

- » Natürliche Implantate 45°
- » Impianto naturale 45°

**Daniel**  
REF. 06148

- » Klassische 90°-Implantate
- » Impianto naturale 45°

**Daniel**  
REF. 04908



15 - 18 cm

Ø 54 cm



15 - 18 cm

Ø 54 cm



### Halter schaufensterkopf Supporti per teste studio

» Kunststoff  
» Plastica



1 u.m.vta  
25 box

REF. 00983

» Kunststoff  
» Plastica



1 u.m.vta  
50 box

REF. 01461

» Kunststoff  
» Plastica



1 u.m.vta  
10 box

REF. 06276

» Kunststoff  
» Plastica



1 u.m.vta  
10 box

REF. 06162

» Aluminium  
» Alluminio



1 u.m.vta  
12 box

REF. 03625

### Stativ Halter Schaufensterkopf Supporti a treppiede per teste studio

» Aluminium  
» Alluminio

1 u.m.vta  
10 box

REF. 03738

» Aluminium  
» Alluminio

1 u.m.vta  
1 box

REF. 03624

» Aluminium  
» Alluminio

1 u.m.vta  
6 box

REF. 01841



166 - 81 cm



133 - 65 cm



126 - 78 cm





# Spezial Schönheitsbehandlung

## SPECIALE ESTETICA

## 01 Linie Gesichtspflege Linea cura del viso 528

Reinigung und Vorbereitung der Haut .....	529
<i>Pulizia e preparazione della pelle</i>	
Crems und Behandlung, Ätherische Öle .....	531
<i>Creme e trattamenti, Oli essenziali</i>	
Aussteller und Zubehör · <i>Espositori e accessori</i> .....	542
Inhalatoren und Zubehör · <i>Vaporizzatori e accessori</i> .....	543

## 02 Linie Körperpflege Linea per la cura del corpo 546

Crems und Behandlungen, basisöle .....	547
<i>Creme e trattamenti, oli base</i>	
Zubehör · <i>Accessori</i> .....	555

## 03 Haarentfernung Epilazione 556

Wachs kg · <i>Cera, formato KG</i> .....	557
Zubehör Wachs kg · <i>Accessori cera kg</i> .....	562
Wachs Format Roll-on · <i>Cera formato roll-on</i> .....	568
Zubehör Wachs-Roll-on · <i>Accessori per cera roll-on</i> .....	571
Enthaarungspinzetten · <i>Pinzette depilatorie</i> .....	580

## 04 Maniküre und pediküre Manicure e pedicure 586

Nagellacke POLLIÉ · <i>Pollié nail polish</i> .....	587
Semi-permanenter Nagellack P-LACK .....	593
<i>Smalto semipermanente P-LACK</i>	
Acryl-Gel · <i>Acrylic gel</i> .....	596
Nagellackentferner · .....	598
<i>Solvente per unghie</i>	
Gel- und Acryl-Pinsel · <i>Pennelli per gel e acrilico</i> .....	601
NAIL ART · <i>NAIL ART</i> .....	603
Lampen · <i>Lampade LED</i> .....	612
Paraffin · <i>Paraffina</i> .....	618
Nagelfräsern · <i>Micromotori</i> .....	620
Lupen · <i>Lenti d'ingrandimento</i> .....	629
Nagelfeile und Polierblöcke · <i>Lima e blocco per lucidare</i> .....	631
Sterilisator · <i>Sterilizzatori</i> .....	648
Nagelhautzange · <i>Tagliacuticole</i> .....	650
Nagelknipser für fingernägel · <i>Tagliaunghie</i> .....	655
Schieber · <i>Spingitori</i> .....	659
Accessoires Maniküre · <i>Accessori per manicure</i> .....	660
Haut- und Fingernagelscheren · <i>Forbici per pellicine e unghie</i> .....	661
Hautschieber .....	663
<i>Bastoncini arancio</i>	
Spezifische Pediküre · <i>Pedicure specifiche</i> .....	664

## 05 Make-up Trucco 674

Stifte, Eyeliner und wimpermaske .....	675
<i>Matite, eyeliner e mascara</i>	
Abschminkschwämme · <i>Spugne struccanti</i> .....	680
Schwämme Make-up · <i>Spugne per il trucco</i> .....	682
Pinsel / Make-up-Pinsel .....	685
<i>Pennelli per il trucco</i>	

## 06 Wimpern Ciglia 700

Wimpern POLLIÉ · <i>Ciglia POLLIÉ</i> .....	701
Wimpern ANDREA · <i>Ciglia ANDREA</i> .....	706
Kits Wimpern, Strähnen und Haar für Haar .....	710
<i>Kit per ciglia, ciocche e pelo per pelo</i>	
Verkaufsträger, Wimpernkleber und Accessoires .....	712
<i>Espositori, colla per ciglia e accessori</i>	
Augenbrauen · <i>Sopracciglia</i> .....	713

## 07 Accessoires und hygiene Accessori e igiene 714

Abdeckungen und Papier für Kosmetikstuhl .....	715
<i>Fodere e carta coprilettino</i>	
Handtücher und Bettwäsche .....	716
<i>Asciugamani e lenzuola</i>	
Schutzausrüstung · <i>Protettori, Guanti</i> .....	719
Einmaliger Gebrauch · <i>Monouso</i> .....	722
Baumwolle · <i>Cotone</i> .....	728
Spiegel · <i>Specchi</i> .....	729
Hygienischen Gesichtsmasken · <i>Maschere facciali</i> .....	735
Kleidung / Uniformen · <i>Abbigliamento / uniformi</i> .....	737
Led ringleuchte · <i>Arco luminoso a led</i> .....	743
Koffer · <i>Valigie</i> .....	744
Pulverisatoren · <i>Spruzzini</i> .....	750
UV-Schutz · <i>Protettori UV</i> .....	751
Antiseptika und Desinfektionsmittel .....	752
<i>Antisettici e disinfettanti</i>	

## 08 Mobiliar Complementi d'arredo 756

Kosmetikstühle · <i>Lettoni</i> .....	757
Maniküretisch · <i>Tavolo da manicure</i> .....	762
Wagens Maniküre/Pediküre .....	764
<i>Carrelli per manicure/pedicure</i>	
Wagens Maniküre/Pediküre .....	765
<i>Carrelli per manicure/pedicure</i>	
Handkoffer und Stühle de Make-up .....	771
<i>Valigie e sedie per il trucco</i>	

Die in diesem Katalog aufgeführten Preise sind empfohlene Preise, Steuern nicht inbegriffen.  
Die Preise gelten bis auf Tippfehler.  
Industrias Oriol 1942, S.L. behält sich das Recht vor, Änderungen ohne vorherige Ankündigung vorzunehmen.

*I prezzi indicati in questo catalogo sono prezzi consigliati, IVA esclusa.  
I prezzi saranno validi salvo errori tipografici.  
Industrias Oriol 1942, S.L. si riserva il diritto di apportare modifiche senza preavviso.*



01

# Linie gesichtspflege

LINEA CURA  
DEL VISO

*Reinigung und Reparatur der Haut,  
Cremes und Behandlung,  
Verkaufsträger, Zubehör...*

*Pulizia e riparazione della pelle,  
creme e trattamenti, espositori,  
accessori...*



## Mizellenwasser vs Reinigungsmilch Acqua micellare vs latte detergente



Für eine gute Gesichtereinigung sind eine Reinigungsmilch, die Hautverunreinigungen beseitigt, und ein Gesichtswasser, das neben seiner zusätzlichen Reinigungskraft auch desinfiziert und die Poren schließt, unverzichtbar. Das Gesichtswasser und die Reinigungsmilch Tassel enthalten hautschonendes Azulen. Alternativ kann auch Mizellenwasser verwendet werden. Dies reinigt schnell und ist sanft zur Haut. Unsere Produktpalette bietet eine große Auswahl, bei der Sie das für Sie passende Produkt finden werden.

*Per una buona pulizia del viso è essenziale un latte detergente che rimuova tutto lo sporco e un tonico che pulisca i resti disinfettando e chiudendo i pori. Il latte e il tonico detergente Tassel contengono azulene, più delicato sulle pelli sensibili. È possibile inoltre utilizzare acqua micellare che consente di risparmiare passaggi nel processo di pulizia ed è delicata sulla pelle. Varie opzioni per purificare la tua pelle. Scegli il tuo prodotto!*

### Reinigungsmilch Latte detergente



500 ml

REF.07094



### Revitalisierendes Gesichtswasser Tonifico rivitalizzante



500 ml

REF.07095



#### Arganöl und Aloe vera

Die Verwendung der Reinigungsmilch hilft, die Unreinheiten und die in der Haut angesammelten Schmutzreste zu entfernen. Auf diese Weise wird die Haut mit Sauerstoff versorgt, strahlt mehr und sieht gesünder aus. Mit Azulen für empfindliche Haut, fettet nicht. Für den täglichen Gebrauch.

#### Olio di argan e aloe vera

*L'utilizzo del latte detergente aiuta a rimuovere le impurità e lo sporco accumulati nella pelle. In questo modo la pelle risulta ossigenata ed appare più luminosa e sana. Con azulene per pelli sensibili, non grassa. Per uso quotidiano.*

#### Arganöl und Aloe vera

Die Verwendung des Gesichtswassers wirkt ausgleichend nach der Reinigung mit der Reinigungsmilch. Es ist der endgültige Schritt, um die Reinigung abzuschließen. Es verschafft der Haut Frische und Vitalität. Enthält Azulen, ideal für empfindliche Haut. Für den täglichen Gebrauch.

#### Olio di argan e aloe vera

*L'utilizzo del tonico per il viso agisce come equilibrante dopo la pulizia con il latte detergente. È il passaggio finale per completarla. Dona freschezza e vitalità alla pelle. Contiene azulene, ideale per pelli sensibili. Per uso quotidiano.*

## Gesichtspeeling

### Esfoliante per il viso



#### Natürliches mineralisches Peeling

Das Arganöl und die Aloe vera besitzen restrukturierende und regenerierende Eigenschaften. Der natürliche mineralische Wirkstoff besitzt großartige Eigenschaften für die Exfoliation. Er entfernt und beseitigt die abgestorbenen Zellen, ohne die Haut zu beschädigen. Die Haut wird sauber, sanft, strahlend und weist eine hohe Atmungsfähigkeit auf, was die Absorption bei jeder Schönheitsbehandlung begünstigt. Kann als übliches Gesichtspeeling verwendet werden.

#### Minerale naturale esfoliante

L'olio di argan e l'olio di aloe vera hanno proprietà ristrutturanti e rigeneranti. Il principio attivo minerale naturale ha grandi proprietà esfolianti. Elimina e rimuove le cellule morte senza danneggiare la pelle, lasciandola pulita, morbida, luminosa e con grande capacità respiratoria, favorendo l'assorbimento di qualsiasi trattamento estetico. Può essere usato come un normale scrub per il viso.



100 ml

REF.06071

## Mizellenwasser

### Acqua micellare



400 ml

REF.04206



## Black Mask Tiefenreinigung

### Black Mask pulizia profonda



50 ml

REF.04580



#### Reinigt, belebt und hydratisiert

Mizellenwasser 3 in 1. Reinigt, entfernt Schminke und beseitigt Unreinheiten der Haut ohne Notwendigkeit des Ausspülens. Erhält das Feuchtigkeitsgleichgewicht und den pH-Wert der Haut und macht sie rein und sanft. Wirkt selbst bei widerstandsfähigem Make-up. Milder Rosenduft.

#### Deterge, tonifica e idrata

Acqua micellare 3 in 1. Deterge, rimuove il trucco e rimuove le impurità dalla pelle senza risciacquare. Rispetta l'equilibrio idrico e del pH della pelle, lasciandola pulita e levigata. Efficace con il trucco più duro. Delicato profumo di rose.

#### Peel-off-Maske:

Das Produkt wird hauptsächlich auf der Grundlage einer sanften und effektiven Formel aus pflanzlicher Aktivkohle, Aloe vera, Hafer und pflanzlichem Glycerin hergestellt. Ermöglicht die Tiefenreinigung der Unreinheiten der Haut, ohne jede schädliche oder aggressive Wirkung auf die Haut.

#### Maschera peel-off:

Prodotto appositamente realizzato sulla base di una formula delicata ed efficace che contiene carbone vegetale attivo, aloe vera, avena e glicerina vegetale. Permette di pulire in profondità le impurità dalla pelle, senza alcun tipo di danno o aggressione.

## TASSEL SKIN COSMETICS bringt die Linie HYALURONIC auf den Markt TASSEL SKIN COSMETICS lancia sul mercato la linea HYALURONIC

Die Hyaluronsäure ist eine strukturelle Komponente der extrazellulären Matrix der Haut, die zusammen mit dem Kollagen und den elastischen Fasern die Struktur der Dermis bilden, und sie ist damit beauftragt, die Haut hydratisiert zu halten. Eine mangelnde Hydratation kann kontraproduktive Auswirkungen auf unsere Dermis und Epidermis haben und macht die Haut empfindlicher für die Faktoren, die das Altern beschleunigen.

*L'acido ialuronico è un componente strutturale della matrice extracellulare della pelle che, insieme al collagene e alle fibre elastiche, formano la struttura del derma cutaneo ed è responsabile del mantenimento dell'idratazione della pelle. Una mancanza di idratazione può produrre effetti controproducenti sul nostro derma e sull'epidermide, rendendo la pelle più sensibile ai fattori che ne accelerano l'invecchiamento.*

» Ref. 07800 auf Seite 541  
 » Rif. 07800 a pagina 541



### Creme hyaluronic Crema hyaluronic



Speziell für dehydrierte Haut. Aufgrund ihrer Zusammensetzung verdichtet sie die Haut erneut und verringert umgehend die Tiefe der Falten. Bekämpft die Gesichtsfältchen. Täglicher Gebrauch.

Eigenschaften:

- » Hochgradig feuchtigkeitsspendend und befeuchtend
- » Verbessert sichtbar die Lipidbarriere der Haut
- » Stimuliert die Zellregeneration der Haut
- » Mildert die Gesichtsfältchen, reduziert die Faltentiefe
- » Füllt die feinen Linien und Falten der Haut auf

Anwendung: auf sauberer Haut sowohl im Gesichtsbereich als auch an Hals und Dekolleté mit sanften kreisenden Massagen anwenden, bis zur vollständigen Absorption. Kann Tag und Nacht angewandt werden, je nach den Erfordernissen der Haut.

*Specifico per pelli disidratate. Per la sua composizione ridensifica la pelle, riducendo immediatamente la profondità delle rughe. Combatte le linee dell'espressione. Per uso quotidiano.*

Proprietà:

- » Altamente idratante e umettante
- » Migliora visibilmente la barriera lipidica della pelle
- » Stimola la rigenerazione delle cellule della pelle
- » Leviga le linee dell'espressione, riducendo la profondità delle rughe
- » Riempie le linee sottili e le rughe della pelle

*Applicazione: applicare sulla pelle pulita della zona del viso, collo e scollatura con delicati massaggi circolari, fino al completo assorbimento. Può essere applicata giorno e notte a seconda delle esigenze della pelle.*



50 ml

REF.06798

### Serum hyaluronic Siero hyaluronic



Faltenfüller. Anti-Aging-Effekt, dämmt die Auswirkungen des Alterungsprozesses ein und hält die Haut hydratisiert, elastisch und strahlend.

Es handelt sich um ein hoch konzentriertes Hyaluronsäure-Serum, das hilft, die Haut zu rehydrieren und gegen Wasserverlust vorzubeugen. Es verstärkt zugleich Ihre Abwehrkräfte und verbessert spürbar Volumen, Festigkeit und Sanftheit der Haut.

Anwendung: morgens und abends vor der Feuchtigkeitscreme auf sauberer und trockener Haut von Gesicht, Hals und anwenden. Bis zur vollständigen Absorption einmassieren.

*Filler antirughe. Effetto anti-età, contrasta gli effetti del passare del tempo, lasciando la pelle più idratata, elastica e luminosa.*

*È un siero ad alta concentrazione di acido ialuronico che aiuta a reidratare la pelle e prevenire la perdita di acqua, rafforzandone le difese e migliorandone notevolmente il volume, la compattezza e la levigatezza.*

*Applicazione: applicare mattina e sera prima della crema idratante, sulla pelle pulita e asciutta di viso, collo e scollatura. Massaggiare fino al completo assorbimento*



50 ml

REF.06799



## Feuchtigkeits-Tagescreme Crema da giorno idratante

### Hydro-nährhaft day - Premium

Hydro-nährhafte Behandlung, die die Mechanismen der Haut stimuliert und wiederherstellt. Dank seiner Wirkstoffe: liposomiertes Gletscherwasser, Hyaluronsäure, Ceramide, Aloe vera und Arganöl, restauriert sie die natürliche Lipidbarriere der Haut und beugt gegen den Verlust von transepidermischem Wasser (TWEL) vor. Verbessert die Sanftheit, die Feuchtigkeitsbilanz und die Flexibilität der Haut.

### Hidra-nutrive day - Premium

Trattamento idro-nutriente che stimola e ripristina i meccanismi della pelle. Grazie ai suoi principi attivi: acqua liposomiale di ghiacciaio, acido ialuronico, ceramidi, aloe vera e olio di argan, ripristina la naturale barriera lipidica della pelle, prevenendo la perdita di acqua transepidermica (TWEL). Migliora la levigatezza, l'equilibrio idrico e la flessibilità della pelle.



50 ml

REF.06451



200 ml

REF.07184



3 ml

REF.06653



## Nährstoffreiche Nachtcreme Crema da notte nutriente

### Arganöl und Aloe vera

Feuchtigkeitscreme, angereichert mit Arganöl und Aloe vera. Indiziert für jeden Hauttyp. Ihre Wirkstoffe stimulieren die Widerstandsfähigkeit der Zellen gegen freie Radikale und helfen bei der Regeneration der Dermis. Verschafft der Haut Leuchtkraft, Glätte und Festigkeit. Rasche Absorption. Täglich anwenden, vorzugsweise abends.

### Olio di argan e aloe vera

Crema idratante arricchita con olio di argan e aloe vera. Adatta a tutti i tipi di pelle. I suoi principi attivi stimolano la capacità cellulare contro i radicali liberi e aiutano la rigenerazione del derma. Dona luminosità, levigatezza e compattezza alla pelle. Rapido assorbimento. Applicare quotidianamente, preferibilmente la sera.



50 ml

REF.03541



200 ml

REF.03699



3 ml

REF.07297

NEW



### Extrakt aus Kaviar und Weinrose Estratto di caviale e rosa mosqueta



#### Kaviar-Pflegecreme Crema nutriente al caviale

Lipoproteinkomplex mit Kaviar, reich an Vitaminen, Aminosäuren und Oligoelementen. Indiziert für dehydrierte und reife Haut, mit regenerierender Wirkung dank der Weinrose. Verhindert und mildert die Spuren des Alterns und von schädlichen Umwelteinflüssen. Rasche Absorption. Für bessere Ergebnisse vorzugsweise zweimal am Tag anwenden.

*Complesso lipoproteico al caviale, ricco di vitamine, aminoacidi e oligoelementi. Indicato per pelli disidratate e mature, ad alto potere rigenerante grazie alla rosa mosqueta. Previene e ammorbidisce i segni del tempo e quelli causati dalle aggressioni esterne. Rapido assorbimento. Per risultati ottimali, applicare preferibilmente due volte al giorno.*



50 ml

REF.03543



200 ml

REF.06452



3 ml

REF.06654



#### Depigmentierende Creme E-Pigment Crema depigmentante E-Pigment

Dafür konzipiert, um auf die dunkelsten Stellen des Gesichts zu wirken, die Produktion von Melanin zu stoppen und die Produktion von neuen Zellen zu stimulieren, die die Haut erneuern, so dass sie ihren normalen Ton wiedergewinnt. Angereichert mit Glycyrrhiza Glabra Root Extract, Kojisäure, Alphahydroxysäure.

- » Reinigt und reduziert die Intensität von Flecken
- » Erhöht die Leuchtkraft und homogenisiert den Hautton
- » Verbessert die Hydratation und die Barrierefunktion der Haut
- » Schützt die Haut vor Sonnenschäden und beugt gegen Flecken vor

*Formulata essenzialmente per agire sulle zone più scure del viso, aiutando a fermarne la produzione di melanina e stimolando la generazione di nuove cellule che rinnovano la pelle, recuperando così il suo tono abituale. Arricchita con estratto di radice di glycyrrhiza glabra, acido cogico, alfa idrossiacidi.*

- » Schiarisce e riduce l'intensità delle macchie
- » Aumenta la luminosità e uniforma il tono della pelle
- » Migliora l'idratazione e la funzione di barriera della pelle
- » Protegge la pelle dai danni del sole e previene la comparsa di macchie



50 ml

REF.06800





### Feuchtigkeitsschme mit Gold Crema idratante con oro

#### Gold und Weinrose

Indiziert für reife Haut, täglicher Gebrauch. Die natürlichen Oligoelemente stimulieren die Widerstandskraft der Zellen gegen freie Radikale, helfen bei der Regeneration der Dermis, wirken gegen Schläfftheit und verschaffen der Haut Leuchtkraft, Glätte und Festigkeit. Emulgator der neuesten Generation: nicht ionisch, natürliches und PEG-freier Emulgator. Stark hydratierende Eigenschaften, verbessert sichtbar die Textur der Haut.

**Gold:** verstärkt die Leuchtkraft (ideal für fahle und sehr dunkle Haut), hat außerdem eine straffende und regenerierende Wirkung, die Haut sieht sichtbar jünger aus

**Argirelox:** dieses Peptid ist ein aktiver Inhaltsstoff, der Gesichtsfältchen bekämpft und die Muskelkontraktion der präsynaptischen Membrane vermindert

**Pollushield:** funktionaler Inhaltsstoff, der als eine Barriere zwischen der Haut und den Schadstoffen in der Umwelt wirkt und auch das Antioxidans-Potenzial der Haut erhöht.

**Weinrose:** natürliche Antifaltencreme, die die Produktion von Kollagen, Elastin und Hyaluronsäure fördert, welche der Haut Festigkeit und Elastizität geben

#### Oro e rosa mosqueta

Indicato per pelli mature, uso quotidiano. Gli oligoelementi naturali stimolano la capacità cellulare contro i radicali liberi, aiutano a rigenerare il derma, agiscono contro la flaccidità e donano luminosità, compattezza e alla pelle.

Emulsionante di ultima generazione: emulsionante non ionico, naturale e PEG-free. Notevoli proprietà idratanti e texture della pelle visibilmente migliorata.

**Oro:** esalta la luminosità (ideale per pelli spente e molto scure) ha anche un effetto tensore e rigenerante, pelle visibilmente più giovane

**Argirelox:** questo peptide è un ingrediente attivo che combatte le rughe di espressione attenuando la contrazione muscolare a livello pre-sinaptico.

**Pollushield:** ingrediente funzionale che funge da barriera tra la pelle e le sostanze inquinanti nell'ambiente e aumenta anche il potenziale antiossidante della pelle

**Rosa mosqueta:** antirughe naturale che favorisce la produzione di collagene, elastina e acido ialuronico, che donano compattezza ed elasticità alla pelle



50 ml

REF.04980



200 ml

REF.07185



3 ml

REF.06655



**Active cells · Anti-Aging · pflanzliche Stammzellen**  
 Active cells · antietà · cellule staminali vegetali



Der Extrakt aus Stammzellen pflanzlichen Ursprungs verhindert und verlangsamt das frühzeitige Altern. Hilft bei der Stimulierung der Regeneration des Hautgewebes, dem er Festigkeit und Elastizität verleiht, und schwächt die durch den Alterungsprozess auftretenden Flecken und Falten ab. Serum von rascher Absorption wegen seiner leichten Textur. Das Serum vor der Creme anwenden und beide Produkte für ein wirksames Ergebnis verwenden.

**Eigenschaften:**

Anti-Aging-Wirkung, die den Prozess des Alterns verlangsamt und die Zellregeneration des Hautgewebes stimulieren. Reparatur der schädlichen Umweltwirkungen, besonders der Verschmutzung und der UV-Strahlung.

*L'estratto di cellule staminali di origine vegetale previene e rallenta l'invecchiamento precoce. Aiuta a stimolare la rigenerazione del tessuto cutaneo, donandogli compattezza, elasticità e attenuando le macchie e le rughe prodotte dal passare del tempo. Siero a rapido assorbimento grazie alla sua texture leggera. Applicare il siero prima della crema e utilizzare entrambi i prodotti per un risultato più efficace.*

**Proprietà:**

*Anti invecchiamento e anti età, poiché rallenta il processo di invecchiamento e stimola la rigenerazione cellulare del tessuto cutaneo. Riparazione degli effetti nocivi dell'ambiente, in particolare dell'inquinamento e della radiazione UV.*



» Ref. 03926 auf Seite 542  
 » Rif. 03926 a pagina 542

**Creme**  
**Crema**



50 ml

REF.03702

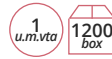

3 ml

REF.06656



30 ml

REF.03703



Halbflüssige Creme von rascher Absorption. Indiziert für reife Haut. Für eine wirksamere Behandlung nach dem Serum Verwenden. Der tägliche Gebrauch Tag und Nacht wird empfohlen.

*Crema semifluida a rapido assorbimento. Indicato per pelli mature. Utilizzare dopo il siero per un trattamento più efficace. Si consiglia l'uso quotidiano giorno e notte.*

**Serum**  
**Eliianr Serum**



Serum von rascher Absorption und leichter Textur. Das Serum vor der Creme anwenden. Für ein wirksames Ergebnis beide Produkte anwenden. Täglicher Gebrauch.

*Siero a rapido assorbimento grazie alla sua texture leggera. Applicare il siero prima della crema. Usa entrambi i prodotti per un risultato più efficace. Per uso quotidiano.*



## Kollagen Collagene



### Unmittelbare Wirkung

Kollagen-Konzentrat. Dank seiner festigenden Kraft und seiner Konzentration wird die Schlaffheit des Gesichts schrittweise korrigiert, insbesondere in den Bereichen rund um Augen, Lippen, Hals usw. Täglicher Gebrauch. Schmiert nicht und wird schnell absorbiert. Täglich anwenden.

30 ml

REF.03548

### Effetto immediato

Concentrato di collagene. Grazie al suo potere rassodante e alla sua concentrazione, la flaccidità del viso viene gradualmente corretta, soprattutto nelle zone del contorno occhi, delle labbra, del collo, ecc. Uso quotidiano. Non unge e si assorbe rapidamente. Applicare quotidianamente.



» Ref. 04664 auf Seite 542

» Rif. 04664 a pagina 542

## Augenkontur Focus 3 Contorno occhi Focus 3

Creme mit frischer und leichter Textur, die bei der Reparatur der kleinen Falten der Augenkontur dank folgender Wirkstoffe hilft:

**1. Vitamin C:** antioxidierend, wirkt gegen freie Radikale

**Kamille:** beruhigend und abschwellend

**Beta-Carotine:** Anti-Aging-Effekt

2. Sorgt für Glätte, hilft bei der Bekämpfung von Tränensäcken, Augenringen und Anzeichen von Müdigkeit. Für den täglichen Gebrauch

*Crema dalla texture fresca e leggera che aiuta a riparare le piccole rughe del contorno occhi grazie ai suoi principi attivi:*  
**1. Vitamina C:** antiossidante e anti-radicali liberi

**Camomilla:** lenitiva e decongestionante

**Beta-caroten:** anti invecchiamento

2. Dona morbidezza, aiuta a combattere borse, occhiaie e segni di stanchezza. Per uso quotidiano.



30 ml

REF.03741



3 ml

REF.06658





## Adstringierende fettige Hautlinie Linea astringente per pelli grasse



### Reinigungsmousse T-PURITY Mousse detergente T-PURITY



200 ml

REF.06084

Linie fettige  
Haut /  
adstringierend  
Linea pelle grassa  
/astringente

Ausgezeichnete talkregulierende, feuchtigkeitsspendende und spülende Eigenschaften für die Haut, mit denen das Make-up, die Unreinheiten und den Überschuss an Fett sanft entfernt werden, ohne die Haut zu reizen. Ihre flüssige Textur wird zu einem leichten, sanften Schaum, der für eine Tiefenreinigung sorgt, hydratiert und das Gleichgewicht der Haut verbessert. Sorgt für ein seidennattes und samtiges Aussehen der Haut.

Segensreich aufgrund ihrer Wirkstoffe: feinere und reduzierte Poren, schattierter Glanz, sanftere und reinere Hauttextur, weiches und mattifiziertes Aussehen.

*Eccellenti proprietà sebo-regolatrici, idratanti e balsamiche per la pelle che rimuovono delicatamente trucco, impurità e sebo in eccesso senza irritare la pelle. La sua texture liquida si trasforma in una schiuma leggera e morbida che fornisce una pulizia profonda, idratando e mantenendo l'equilibrio della pelle. Recupera un aspetto opaco e vellutato.*

*Grazie ai suoi principi attivi, apporta benefici: pori ridotti e più fini, lucentezza sfocata, texture della pelle levigata e purificata, aspetto levigato e opaco.*

### Adstringierende Creme T-PURITY Crema astringente T-PURITY

Frisches Creme-Gel mit leichter Textur, speziell zubereiteten Wirkstoffen, die feuchtigkeitsspendend, talkregulierend und mattifizierend gegen das Glänzen wirken, das durch den Fettüberschuss auf der Haut entsteht. Minimiert Poren, schwarze Punkte und Mitesser. Ist mit pflanzlichen Wirkstoffen zubereitet, die die Lipidbarriere erneuern sowie entzündungshemmend, mattifizierend und talkregulierend wirken.

*Crema-gel fresca e dalla texture leggera, formula con principi attivi idratanti, sebo-regolatori e opacizzanti della lucentezza causata dall'eccesso di sebo sulla pelle. Riduce al minimo i pori, i punti neri e i brufoli. Formula con principi attivi vegetali che agiscono come antinfiammatori, ristrutturanti della barriera lipidica, opacizzanti e sebo-regolatori.*

Linie pieles  
grasas /  
astringentes  
Linea pelle grassa  
/astringente



50 ml

REF.06086

### Gesichtswasser adstringierend T-PURITY Tonico astringente T-PURITY



200 ml

REF.06085

Linie fettige  
Haut /  
adstringierend  
Linea pelle grassa  
/astringente

Adstringierendes Gesichtswasser, besonders für fettige Haut geeignet, regelt den Fettüberschuss, verhindert das Glänzen und hilft, Hautunreinheiten zu beseitigen.

Dank seiner Wirkstoffe schließt es die Poren, sorgt für einen seidenmatten und sanften Effekt auf der Haut und kontrolliert das Glänzen und das Fett auf der Haut. Bekämpft und verhindert Hautunreinheiten: regulierende Eigenschaften des Talgs, hilft, die Verbreitung von Bakterien zu kontrollieren und verhindert die Infektion der Poren, die zu Akne führen kann.

*Tonico astringente per il viso, appositamente formulato per la pelle grassa, regola il sebo in eccesso, previene la lucentezza e aiuta ad eliminare le macchie.*

*Grazie ai suoi principi attivi, restringe i pori, aiuta a ottenere un effetto levigato e opaco sulla pelle controllando la lucentezza e il grasso sulla pelle. Combatte e previene le macchie: proprietà sebo-regolatrici, aiuta a controllare la proliferazione batterica, prevenendo l'infezione dei pori che causa l'acne.*



3 ml

REF.06657



**Ätherische Öle · Oli essenziali**

Die meisten ätherischen Öle werden durch Destillation und Kaltpressung gewonnen; so erhält man eine Flüssigkeit, die die reine Essenz der Pflanze darstellt und es uns ermöglicht, alle ihre Eigenschaften zu nutzen.

*La maggior parte degli oli essenziali si ottengono per distillazione e pressione a freddo, in questo modo è possibile ottenere un liquido che rappresenta la pura essenza della pianta e ci permette di godere di tutte le sue proprietà.*



» Ref. 04995  
auf Seite 542  
» Rif. 04995 a  
pagina 542

**Ätherisches Öl Lavendel · Olio essenziale di lavanda**

Dies ist ein natürliches Antibiotikum und ein Antiseptikum mit heilender Wirkung. Entwässert und bekämpft die Cellulite, hilft, die Knoten unter der Haut zu beseitigen und ist ein großartiges Antiseptikum. Wirkt effektiv gegen Mikroorganismen wie Bakterien und Pilze. Entzündungshemmend, bekämpft Hautprobleme wie die Akne. Hilft auch, die Dermis nach Sonnenbrand zu regenerieren, da es den Zellstoffwechsel aktiviert. Der Lavendel trägt zur aktiven Regeneration des Gewebes bei, um die Haut jünger zu erhalten. Sorgt für zusätzliche Hydratation. Einige Tropfen dieses Öls können auch bei jeder anderen Gesichts- oder Körperbehandlung angewandt werden.

*È un antibiotico naturale e un agente antisettico e curativo. Drena, combatte la cellulite, aiuta a diluire i noduli sottocutanei ed è un ottimo antisettico. Agisce efficacemente contro i microrganismi batterici e fungini. Antinfiammatorio, combatte i problemi della pelle come l'acne. Aiuta anche a rigenerare il derma dopo le ustioni, poiché attiva il metabolismo cellulare. La lavanda contribuisce alla rigenerazione attiva dei tessuti per mantenere la pelle più giovane. Fornisce idratazione extra. È possibile anche applicare alcune gocce di questo olio in qualsiasi trattamento per viso o corpo.*



30 ml

REF.06049

15 ml

REF.06044

**Ätherisches Öl Weinrose · Olio essenziale di rosa mosqueta**

Regeneriert der Haut hervorragend. Wirkt oberflächlich als natürlich befeuchtender Faktor und verbessert die Hydratation. Nährt und regeneriert, schwächt Narben und Falten sichtbar ab. Korrigiert und verhindert Hautprobleme aufgrund von Lichtalterung, mit Hilfe der Selbsterzeugung von Melanin. Um Striemen während der Schwangerschaft zu verhindern, wird ihr Gebrauch während des letzten Quartals der Schwangerschaft an Bauch und Brüsten empfohlen. Trägt dazu bei, die Pigmentierung zu verteilen, so dass die Flecken abgeschwächt oder beseitigt werden, etwa bei Akne, Sonnenflecken usw. Kräftigend, mit heilender und verjüngender Wirkung, verhindert die Oxidation der Zellen.

*Ottimo rigeneratore della pelle. Agisce in superficie come fattore idratante naturale, migliorando l'idratazione. Nutre e rigenera, attenuando visibilmente cicatrici e rughe. Corregge e previene i problemi cutanei dovuti al fotoinvecchiamento, attraverso l'autogenerazione della melanina. Per evitare le smagliature durante la gravidanza, si consiglia di utilizzarlo durante l'ultimo trimestre di gravidanza su addome e seno. Contribuisce a ridistribuire la pigmentazione consentendo di ridurre o eliminare macchie dovute a casi di acne, macchie solari, ecc. Azione tonificante, cicatrizzante, ringiovanente e previene l'ossidazione cellulare.*



30 ml

REF.06053

15 ml

REF.06052

**Ätherisches Öl Eukalyptus · Olio essenziale di eucalipto**

Schlank machender Effekt, fördert die Flüssigkeitsretention, adstringierend, wirkt antibakteriell bei Hautproblemen, Pedikulose und Schuppen, erfrischende Wirkung, strafft die peripheren Blutgefäße. (Ideal zum Massieren von müden Beinen). Wenn Sie einige Tropfen dieses Öls Ihrem täglichen Shampoo hinzufügen, ist dies eine großartige Möglichkeit zur Stimulation der Follikel von Haar und Kopfhaut sowie zur Bekämpfung von Schuppen. Einige Tropfen dieses Öls können auch bei jeder anderen Gesichts- oder Körperbehandlung angewandt werden.

*Effetto snellente, astringente, agisce come antibatterico per problemi cutanei, pediculosi e forfora, effetto rinfrescante, restringe i vasi sanguigni periferici. (Ideale per massaggi per gambe stanche). Aggiungere qualche goccia di questo olio al tuo shampoo quotidiano è un'ottima opzione per stimolare i follicoli dei capelli e del cuoio capelluto e per combattere la forfora. Puoi anche applicare alcune gocce di questo olio in qualsiasi trattamento per viso o corpo.*



30 ml

REF.06048

15 ml

REF.06043

**Ätherische Öle · Oli essenziali**

Die meisten ätherischen Öle werden durch Destillation und Kaltpressung gewonnen, auf diese Weise erhält man eine Flüssigkeit, die die reine Essenz der Pflanze darstellt und uns ermöglicht, alle Eigenschaften zu nutzen.

*La maggior parte degli oli essenziali si ottengono per distillazione e pressione a freddo, in questo modo è possibile ottenere un liquido che rappresenta la pura essenza della pianta e ci permette di godere di tutte le sue proprietà.*

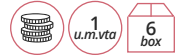

» Ref. 04995  
auf Seite 542  
» Rif. 04995 a  
pagina 542

**Ätherisches Öl Teebaum · Olio essenziale di albero del tè**

Seine Anwendungen basieren im Wesentlichen auf seinen antibakteriellen und antiseptischen Eigenschaften, zu denen ein leichter lokaler anästhetischer Effekt kommt. Seine Eigenschaften: heilende Wirkung, schützt die Haut, wirkt direkt beim Schweißabbau, reinigt die Haut, hilft gegen Ekzeme, Wunden, Flecken an Gesicht, Händen und Dekolleté. Entwässernd und schlank machend. Wird auch für Cuticula verwendet, die durch seine antiseptische Wirkung gereinigt wird.

*Le sue applicazioni sono fondamentalmente basate sulle sue proprietà battericide e antisettiche, alle quali si aggiunge un lieve effetto anestetico locale. Le sue proprietà: cicatrizzanti, dermoprotettive, agisce direttamente sulla degradazione del sudore, demopurificante, combatte eczemi, piaghe, macchie su viso, mani e scollatura. Drenante e snellente. Per la sua azione antisettica viene utilizzato anche per le cuticole dopo che sono state rimosse.*



30 ml

REF.06046

15 ml

REF.06041

**Ätherisches Öl Rosmarin · Olio essenziale di rosmarino**

Haar: empfiehlt sich zur Stärkung des Haars. Stimuliert den Kreislauf, fördert das Wachstum und stärkt die Haarwurzeln. Verbessert die Kapillarstruktur von dünnem und brüchigem Haar.

Haut: Rosmarin wird häufig in kosmetischen Anti-Aging-Cremes verwendet und ist ein hervorragendes Antioxidans. Einige seiner Komponenten, wie die Rosmarinsäure, fördern die Bildung von neuen Zellen. Es wirkt abschwellend, entzündungshemmend, heilend, erfrischend und adstringierend.

*Capelli: consigliato per rinforzare i capelli. Stimola la circolazione favorendo la crescita, rafforzando le radici e migliorando la struttura capillare dei capelli fini e fragili.*

*Pelle: il rosmarino trova ampio impiego nelle creme cosmetiche anti-età poiché è un ottimo antiossidante. Alcuni dei suoi componenti, come l'acido rosmarinico, favoriscono la formazione di nuove cellule. È decongestionante, antinfiammatorio, cicatrizzante, rinfrescante e astringente.*



30 ml

REF.06047

15 ml

REF.06042

**Ätherisches Öl Minze · Olio essenziale di menta**

Auf der Haut ist es sehr nützlich, da es bei der Feuchtigkeitretention hilft und so frühzeitiges Altern verhindert. Bei Massagen erzeugt es einigen Stellen eine einmalige entspannende Wirkung. Angewandt in einer täglichen Basiscreme, wirkt es gegen Rötung der Haut aufgrund von Entzündungen oder Akne. Ätherisches Öl aus Minze hat folgende Eigenschaften: reguliert das Hautfett, reinigt bei Akne, beseitigt Ödeme und hilft bei der Flüssigkeitsretention, reduziert Cellulite, wirkt abschwellend und erfrischend für die Haut.

*È molto utile sulla pelle in quanto aiuta a trattenere l'umidità, prevenendo l'invecchiamento precoce. Se utilizzato per i massaggi, in zone specifiche, è possibile ottenere un effetto rilassante unico. Applicato insieme a una crema base per uso quotidiano, agisce sugli arrossamenti cutanei dovuti a infiammazioni o acne. L'utilizzo dell'olio essenziale di menta piperita ha proprietà di: regolazione del grasso della pelle, pulizia dell'acne, eliminazione di edemi e ritenzione di liquidi, riduzione della cellulite, azione decongestionante e rinfrescante della pelle.*



30 ml

REF.06050

15 ml

REF.06045

## Gesichtsmaske für normale und gemischte Haut

### Maschera viso per pelli normali e miste



400 ml

REF.04454

#### Bereich T: Stirn, Nase und Kinn

Es handelt sich um eine Kombination für trockene und fettige Haut. Einige Bereiche weisen normalerweise einen Überschuss an Talg auf, wie der Bereich T (Stirn, Nase und Kinn) und andere Stellen leiden mehr unter Dehydrierung, wie etwa im Bereich U (Bereich unterhalb der Wangenknochen und Kiefern).

Seine Wirkstoffe pflanzlichen Ursprungs, Rheum Rhaponticum Root Extract, wirken durch Aktivierung der natürlichen Hydratationsmechanismen der Haut, womit die Hornschicht und dessen Komponenten restrukturiert, das Abblättern reguliert und die Barrierefunktion restauriert werden.

#### Zona T: fronte, naso e mento

*È una combinazione di pelle secca e pelle grassa. Alcune zone tendono ad avere più sebo in eccesso, come la zona T (fronte, naso e mento), e altre zone soffrono maggiormente la disidratazione, come di solito accade alla zona U (zona sotto gli zigomi e la mascella).*

*I suoi principi attivi di origine vegetale, estratto di radice di rheum rhaponticum, agiscono attivando i naturali meccanismi di idratazione della pelle, ottenendo: ricostruzione dello strato corneo e dei suoi componenti, regolazione della desquamazione, ripristino della funzione di barriera.*



## Gesichtsmaske trockene Haut

### Maschera viso per pelli secche



400 ml

REF.04974

#### Hervorragende Hydratation

Trockene Haut benötigt immer eine ausgiebige Hydratation und eine besondere Pflege, da sie leichter rot wird und empfindlicher ist. Daher ist die Gesichtsmaske für empfindliche Haut dank ihrer Wirkstoffe pflanzlichen Ursprungs, Salix alba (Silberweide) Bark-Extrakt, alternifolia melaleuca, Curculigo Orchioides Root Extrakt, wirken auf den inneren Kontrollmechanismus des pH-Werts der Haut, repariert die Barrierefunktion und verursacht eine Verringerung der Reaktivität und Empfindlichkeit der Haut. Somit wird die Kohäsion zwischen den Zellen verbessert und die Integrität der Epidermis wiederhergestellt.

#### Ottima idratazione

*Le pelli secche hanno sempre bisogno di un apporto significativo di idratazione e cure speciali in più, poiché tendono ad arrossarsi facilmente e sono più sensibili. Per questo, la maschera viso per pelli sensibili, grazie ai suoi principi attivi di origine vegetale, estratto di corteccia di salix alba (salice), alternifolia melaleuca, estratto di radice di curculigo orchioides, agisce sul meccanismo interno di controllo del pH cutaneo, riparando la funzione di barriera e provocando una diminuzione della reattività e della sensibilità della pelle. Pertanto, migliora la coesione tra le cellule, ripristinando così l'integrità dell'epidermide.*



## Gesichtsmaske fettige Haut

### Maschera viso per pelli grasse



400 ml

REF.03810

#### Gleicht den Fettüberschuss aus

Bewahrt den Feuchtigkeitsausgleich und verhindert, dass eine äußere Substanz wie z.B. Schweiß oder Feuchtigkeit Bakterien produziert. Eine ihrer Komponenten ermöglicht die Feuchtigkeitsabsorption. Dies hinterlässt auf der Haut einen Schutzfilm, der eine Hautsenkung und gleichzeitig die Reinigung und die Hydratation bewirkt. Der Leaf Extrakt aus der Pflanze Barosma Betulina gleicht den Fettüberschuss aus und behandelt die sichtbaren Poren durch Verringerung ihrer Anzahl und Größe, womit die Talgablagerungen ausgeglichen und die Textur der Haut sichtbar verbessert wird.

#### Bilancia il grasso in eccesso

Mantiene un equilibrio idrico e impedisce a qualsiasi agente esterno come sudore, umidità, ecc., di produrre batteri. Uno dei suoi componenti è responsabile di esercitare un'azione assorbente contro l'umidità. Ciò permette di lasciare sulla pelle un film protettivo che rilascia la pelle, esercitando la sua funzione purificante e idratante. Il suo estratto attivo di foglie di barosma betulina riequilibra il sebo in eccesso e tratta i pori visibili, riducendoli in numero e dimensioni, riequilibrando la secrezione sebacea e migliorando visibilmente la consistenza della pelle.



## Verkaufsträger verschiedene gesichtsmasken

### Espositore hyaluronic (in regalo)



REF.07800

Enthält 2 Cremes mit Hyaluronsäure Ref. 06798 und 2 Seren mit Hyaluronsäure Ref. 06799.

Include 2 creme con acido ialuronico rif. 06798 e + 2 serum con acido ialuronico ref. 06799.

NEW



## Verkaufsträger aus Holz ätherischen Öle Espositore in legno oli essenziali



REF.04995



- » Verkaufsträger aus Holz ätherischen Öle
- » 42 ätherischen Öle
- » 6 Modelle von 15 ml por jede referencia (x6)
- » 1 Modell von 30 ml por jede referencia (x6)
- » Geschenk 20 Broschüren
- » 42 Oli essenziali
- » 6 modelli da 15 ml per ogni riferimento (x6)
- » 1 modello da 30 ml per ogni riferimento (x6)
- » In regalo 20 opuscoli

## Verkaufsträger aus Holz ätherischen Öle 15 ml Espositore in legno oli essenziali 15 ml



REF.04995/01



- » Leer
- » Vuoto

**2 + 1 frei**  
**2 + 1 Gratis**

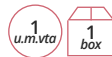

REF.04664



- Verkaufsträger für Cremes, bestehend aus:
- » 3 Tagcremes Hydra-Nutrive (REF. 06451)
  - » 3 Nachtcremes Hydra- Nutrive (REF. 03541)
  - » 3 Feuchtigkeitscremes mit Gold (REF. 04980)
  - » 3 Pflegecremes mit Kaviar (REF. 03543)
  - » 6 Kollagen pur (REF. 03548)
  - » 20 Informationsbroschüren
  - » 12 x 5 Sachets + Poster

Espositore per creme composto da:

- » 3 creme da giorno Hydra-Nutrive (RIF. 06451)
- » 3 creme da notte Hydra-Nutrive (RIF. 03541)
- » 3 creme idratanti con oro (RIF. 04980)
- » 3 creme nutrienti al caviale (RIF. 03543)
- » 6 al collagene puro (RIF. 03548)
- » 20 opuscoli informativi
- » 12 x 5 bustine + poster

**4 + 1 frei**  
**4 + 1 Gratis**

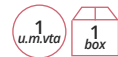

REF.03926



- Verkaufsträger bestehend aus:
- 5 Cremes Active · Cells Anti-Aging aus pflanzlichen Stammzellen (REF. 03702)
  - 5 Seren Active · Cells Anti-Aging aus pflanzlichen Stammzellen (REF. 03703)

Espositore composto da:

- » 5 creme anti-tetà Active Cells con cellule staminali vegetali (RIF. 03702)
- » 5 sieri anti-tetà Active Cells con cellule staminali vegetali (RIF. 03703)

## Gesichtssauna Sauna facciale

MEDISANA®



105 W

REF. 03280

- » Indiziert für die Reinigung der Haut und zur Linderung von Atemwegserkrankungen
- » Zubehör: Messbecher und Zubehörteil für die Nase. Diffusor, damit das Spray konstant bleibt. PTC-Erwärmung von hoher Qualität
- » Leicht zu reinigen
- » Leistung: 105 W

- » *Indicato per la pulizia della pelle e per il sollievo delle malattie respiratorie*
- » *Accessori: misurino e accessorio per il naso. Nebulizzatore per nebulizzazione sia costante. Riscaldamento PTC di alta qualità*
- » *Facile da pulire*
- » *Potenza: 105 W*



## Gesichts-Inhalator Vaporizzatore facciale



1 L

REF. 04952



Nur mit destilliertem Wasser verwenden. Mit Funktion für kalten und warmen Dampf. Der Inhalator umfasst die Funktion OZON-Dampf, was sowohl kalt als auch warm mehr Wasserdampf erzeugt. Wenn das Wasser unter dem Minimum liegt, schaltet sich der Inhalator zur Sicherheit automatisch ab. Das Kopfteil kann um 120° gedreht werden.

- » Spannung: 220-240 V
- » Frequenz: 50-60 Hz
- » Leistung: 650 W
- » Fassungsvermögen Tank: 1 l

*Utilizzare solo con acqua distillata. Con funzione vapore caldo e freddo. Il vaporizzatore ha la funzione vapore di OZONO, che genera più vapore acqueo sia nel vapore caldo che in quello freddo. Quando l'acqua è al di sotto del minimo, il vaporizzatore si spegnerà automaticamente per sicurezza. La testina può ruotare di 120°.*

- » *Voltaggio: 220-240V*
- » *Frequenza: 50-60Hz*
- » *Potenza: 650 W.*
- » *Capacità del serbatoio: 1L*





**Beutel 10 mini-spateln für creme, transparent**  
 Confezione 10 mini spatole per crema trasparenti

1 u.m.vta  
 100 box

REF.07328

NEW



**Gesichts-Massagebürste**  
 Spazzola per massaggio

» Ideal für die Exfoliation  
 » Ideale per esfoliare

1 u.m.vta  
 12 box

REF.01811

» Mit Kabel-Schutzkappe  
 » Con cappuccio protettivo per le setole

1 u.m.vta  
 50 box

REF.06660



**Bohrkrätzer**  
 Schiaccia brufoli

» Großer Schnäpper  
 » Archetto grande

1 u.m.vta  
 50 box

REF.01477

» Kleiner Schnäpper  
 » Archetto piccolo

1 u.m.vta  
 50 box

REF.01478

» Doppelt  
 verwendbar  
 » Duplice uso

1 u.m.vta  
 40 box

REF.01479



16,5 cm



16 cm



13,5 cm

## Konjakwurzel-Schwämme

### Spugne Konjac



Schwämme mit extra feiner Textur, hergestellt auf der Grundlage von Konjakwurzeln, reich an Mineralien. Er ist 100% natürlich, biologisch abbaubar, nachhaltig und umweltfreundlich. Frei von Farbstoffen, Konservierungsmitteln und künstlichen Pigmenten. Antimikrobiell dank seiner alkalischen Beschaffenheit und mit hoher Hautreinigungsfähigkeit. Mit dem Schwamm ist es nicht notwendig, Seife oder Reinigungsmittel verwenden, da der Schwamm selbst die Fähigkeit besitzt, den gesamten Schmutz und die Unreinheiten der Haut zu entfernen.

*Spugne dalla texture extra fine a base di radici di konjac, ricche di minerali. 100% naturali, biodegradabili, sostenibili e rispettose dell'ambiente. Senza coloranti, conservanti e pigmenti artificiali. Antimicrobico grazie alla sua natura alcalina e con grande capacità di pulire la pelle. Con l'utilizzo della spugna, non è necessario utilizzare sapone o detergenti, poiché la sola spugna ha la capacità di rimuovere tutto lo sporco e le impurità dalla pelle.*



REF.04970



#### Holzkohle aus natürlichem Bambus

- » Beseitigt den Überschuss an Talg, sanfte Exfoliation, reinigt die Poren in der Tiefe, welche Bakterien ansammeln können, die zu Akne führen
- » Beseitigt die schwarzen Punkte und hinterlässt einen Film zur Versorgung und Verbesserung der Schutzbarriere der Haut, ohne Notwendigkeit der Verwendung von chemischen Scheuermitteln
- » Bringt den pH-Wert der Haut ins Gleichgewicht
- » Besonders indiziert für fettige Haut und mit Tendenz zu Akne
- » Nicht geeignet für empfindliche Haut
- » Der Schwamm muss alle 2 Monate ausgetauscht werden

#### Carbone di bambù naturale

- » Rimuove il sebo in eccesso, esfolia delicatamente, purifica in profondità i pori che possono portare a batteri che causano l'acne
- » Elimina i punti neri lasciando un film per nutrire e migliorare la barriera protettiva della pelle, senza bisogno di abrasivi chimici
- » Riequilibra il pH della pelle
- » Particolarmente indicata per pelli grasse e a tendenza acneica
- » Non adatta per pelli sensibili.
- » La spugna deve essere sostituita ogni 2 mesi



REF.04971



#### Aloe vera. Beruhigend, feuchtigkeitsspendend und befeuchtend

- » Bringt den pH-Wert Ihrer Haut ins Gleichgewicht
- » Hinterlässt einen Film zur Versorgung und Verbesserung der Schutzbarriere der Haut
- » Sie können sie nach der Haarentfernung verwenden, denn sie hilft dabei, die Haut zu beruhigen und zu befeuchten
- » Ideal für normale und gemischte Haut
- » Der Schwamm muss alle 2 Monate ausgetauscht werden

#### Aloe Vera. Calmante, idratante e umettante

- » Riequilibra il pH della pelle
- » Lascia un film per nutrire e migliorare la barriera protettiva della pelle
- » Puoi usarlo dopo la ceretta perché aiuta a lenire e idratare la pelle
- » Ideale per pelli normali e miste
- » La spugna deve essere sostituita ogni 2 mesi



REF.04972



#### Samen der Damaszener-Rose. Hydratisiert, nährt und regeneriert

- » Hinterlässt einen Film, der befeuchtet, nährt und die Schutzbarriere der Haut verbessert
- » Reduziert die Notwendigkeit der Verwendung von Seifen, die Ihre delikate Haut reizen können
- » Besitzt einen natürlichen beruhigenden Effekt
- » Besonders indiziert für sehr empfindliche Haut, selbst in frühem Alter
- » Der Schwamm muss alle 2 Monate ausgetauscht werden

#### Semi di rosa bulgara. Idrata, nutre e rigenera

- » Lascia un film ideale per umettare, nutrire e migliorare la barriera protettiva della pelle
- » Riduce la necessità di saponi che possono irritare le pelli delicate
- » Ha un effetto calmante naturale
- » Particolarmente adatta per pelli molto sensibili e anche in tenera età
- » La spugna deve essere sostituita ogni 2 mesi

02

# Linie körperpflege

LINEA PER  
LA CURA DEL  
CORPO

*Cremes, Behandlungen  
und Zubehör...*

*Crema, trattamenti  
e accessori...*



**Basisöle · Oli base**

Basisöle sind auch bekannt als Trägeröle. Sie wirken als Träger bei der Anwendung der ätherischen Öle im Gesicht und am Körper und sorgen die notwendige Beweglichkeit bei der Massage durch die Schmierung, die sie bieten. Zugleich bieten sie die für die Mischung eigenen therapeutischen Eigenschaften. Es sind feste Öle, d.h. sie verdampfen nicht (im Unterschied zu den ätherischen Ölen).

Angereichert mit Traubenkernöl. Hochgradig erweichend, schützende Eigenschaften, ideal als Vehikel zur Durchdringung für andere Komponenten, wenn es mit verschiedenen Wirkstoffen kombiniert wird. Wegen seines hohen Gehalts an Antioxidantien, Vitaminen C, D, E und Beta-Carotin, erhöht es die Widerstandskraft der Haut und macht sie elastischer. Wird sehr schnell absorbiert und kann für jeden Hauttyp verwendet werden.

*Gli oli base sono anche noti come oli vettori o portanti. Agiscono come vettori portanti nell'applicazione degli oli essenziali su viso e corpo, facilitando il movimento necessario nel massaggio grazie alla lubrificazione che offrono e, a loro volta, conferiscono alla miscela le proprie proprietà terapeutiche. Sono oli fissi, cioè non evaporano (a differenza degli oli essenziali che lo fanno).*

*Arricchiti con olio di vinaccioli. Proprietà altamente emollienti e protettive, ideale come veicolo di penetrazione di altri componenti in combinazione con diversi principi attivi. Per il suo alto contenuto di antiossidanti, vitamine C, D, E e betacarotene, aumenta la resistenza della pelle, rendendola più elastica. Si assorbe molto rapidamente e può essere utilizzato su qualsiasi tipo di pelle.*

**Basisöl Ringelblume**  
**Olio base di calendula**

Besitzt entzündungshemmende und beruhigende Eigenschaften; vor allem nach aggressiven Behandlungen für die Haut wie die Haarentfernung oder ein Peeling erzeugt das Öl ein Gefühl der Entspannung und lindert Rötungen. Hohe feuchtigkeitsspendende Wirkung, nahrhaft und reinigend. Besonders nützlich für empfindliche Haut wie die von Babys oder Menschen mit ständigen Reizungen. Geeignet für trockene oder sehr trockene Haut. Reich an Vitamin E. Kann direkt als Reinigungsmilch verwendet werden, vor allem bei sehr empfindlicher Haut, die leicht gereizt wird

*Ha proprietà antinfiammatorie e lenitive, quindi dopo aver sottoposto la pelle a trattamenti aggressivi come la ceretta o l'esfoliazione, l'uso dell'olio produce una sensazione di rilassamento e sollievo contro gli arrossamenti. Alto potere idratante, nutriente e struccante. Particolarmente utile per la pelle sensibile come quella dei bambini o delle persone che soffrono di irritazioni costanti. Adatto per pelli secche o molto secche. Ricco di vitamina E. Può essere utilizzato direttamente come struccante, soprattutto su pelli molto sensibili e facilmente irritabili.*



1 L

REF.06036

**Basisöle · Oli base****Basisöl Süße Mandeln**  
**Olio base di mandorle dolci**

Das Öl aus süßen Mandeln ist eines der Öle par excellence für die Massage. Eigenschaften: gibt der Haut Elastizität und Glätte. Gute Durchdringung der Haut, hinterlässt kein Fett auf der Haut. Nahrhaft und regenerierend. Geeignet für jeden Hauttyp, auch von Kindern und von älteren Menschen. Ideal für brüchige oder rissige Haut. Stärkend für die schwachen Haare, trägt zum Entfernen von Schuppen auf der Kopfhaut bei. Es ist ein natürlicher Feuchtigkeitsspender und regeneriert die Wimpern.

*L'olio di mandorle dolci è uno degli oli da massaggio per eccellenza. Proprietà: dona elasticità e levigatezza alla pelle. Buona penetrazione cutanea, non lascia la pelle grassa. Nutriente e rigenerante. Adatto a tutti i tipi di pelle compresi bambini e anziani. Ideale per pelli fragili o screpolate. Rinforza i capelli deboli, aiuta la scomparsa delle squame sul cuoio capelluto. È un rigeneratore e idratante naturale per le ciglia.*



1 L

REF.06037

**Basisöl Weinrose**  
**Olio essenziale di rosa mosqueta**

Die Weinrose ist regeneriert die Haut hervorragend. Wirkt oberflächlich als natürlicher befeuchtender Faktor und verbessert die Hydratation. Nährt und regeneriert, schwächt Narben und Falten sichtbar ab. Korrigiert und verhindert die Probleme der Haut aufgrund von Lichtalterung durch die Selbsterzeugung von Melanin. Trägt zur Neuverteilung der Pigmentierung bei, wodurch die Flecken abgeschwächt oder beseitigt werden. Kräftigende und heilende Wirkung, verjüngend, verhindert die Oxidation der Zellen.

*La rosa mosqueta è un ottimo rigeneratore della pelle. Agisce in superficie come fattore idratante naturale, migliorando l'idratazione. Nutre e rigenera, attenuando visibilmente cicatrici e rughe. Corregge e previene i problemi cutanei dovuti al fotoinvecchiamento, attraverso l'autogenerazione della melanina. Aiuta a redistribuire la pigmentazione e a schiarire ed eliminare le macchie. Azione tonificante, cicatrizzante, ringiovanente che previene l'ossidazione cellulare.*



1 L

REF.06035

**Basisöl Jojoba**  
**Olio base di jojoba**

Hervorragende Hautpenetration, hinterlässt aufgrund seiner guten Absorptionsfähigkeit kein Fett auf der Haut. Für fettige Haut sowie für die Anti-Akne-Behandlung empfohlen, wegen seiner antibakteriellen Eigenschaften, und zur Anti-Talg-Behandlung, da es den Talg auflöst, der sich in den aktiven Hautfollikeln absetzt und das Kapillarwachstum behindert. Hervorragendes Kapillaröl, das trockene und brüchige Haare nährt. Wirkt als Schutz gegen mögliche Reizungen oder Störungen der Haut durch Färbungen und Dauerwellen.

*Ottima penetrazione cutanea, non lascia la pelle grassa grazie alla sua ottima capacità di assorbimento. Indicato per pelli grasse oltre che per trattamenti anti-acne per le sue proprietà battericide e come trattamento antiseborroico poiché scioglie il sebo che si deposita nei follicoli piliferi attivi, ostacolando la crescita dei capillari. Ottimo olio per capelli in quanto nutre i capelli secchi e fragili. Agisce come protettore contro possibili irritazioni o alterazioni della pelle causate da coloranti e permanenti.*



1 L

REF.06038

**Basisöle · Oli base****Basisöl Teebaum**  
**Olio base di albero del tè**

Seine Anwendungen basieren im Wesentlichen auf seinen antibakteriellen und antiseptischen Eigenschaften, zu denen noch ein leichter lokaler anästhetischer Effekt kommt. Seine Eigenschaften: heilend, hautschützend, wirkt direkt beim Abbau von Schweiß, hautreinigend, hilft gegen Ekzeme, Wunden, Flecken an Gesicht, Händen, Dekolleté. Entwässernd und schlank machend. Wird auch für die Cuticula verwendet, die durch seine antiseptische Wirkung gereinigt wird.

*Le sue applicazioni sono fondamentalmente basate sulle sue proprietà battericide e antisettiche, alle quali si aggiunge un lieve effetto anestetico locale. Le sue proprietà: cicatrizzanti, dermoprotettive, agisce direttamente sulla degradazione del sudore, dermopurificante, combatte eczemi, piaghe, macchie su viso, mani e scollatura. Drenante e snellente. Per la sua azione antisettica viene utilizzato anche per le cuticole dopo che sono state rimosse.*



1 L

REF.06051

**Basisöl Olive**  
**Olio base di oliva**

Erweichend, Antioxidantien, belebende, feuchtigkeitsspendend und mit beruhigenden Eigenschaften. Hat eine Fettzusammensetzung, die dem der menschlichen Haut sehr ähnlich ist. Restauriert die Feuchtigkeit und die Barrierefunktion der Haut und begünstigt die Zellregeneration. Seine Anwendung auf der Haut wirkt erweichend, es repariert und schützt vor vorzeitigem Altern. Antimikrobielle und antibakterielle Wirkung.

*Proprietà emollienti, antiossidanti, tonificanti, idratanti e calmanti. Ha un profilo lipidico molto simile a quello della pelle umana. Ripristina l'idratazione e la funzione barriera della pelle, favorendo la rigenerazione cellulare. La sua applicazione sulla pelle agisce come emolliente, riparatore e protegge dall'invecchiamento precoce. Attività antimicrobica e antibatterica.*



1 L

REF.06039

**Basisöl Argan**  
**Olio base di Argan**

Enthält Antioxidantien wie Vitamin E und ist reich an Fettsäuren. Regenerierend und festigende de Geweben, da es die Kollagen- und Elastinfasern stärkt, die Hautbarriere verbessert und die Reduzierung des Feuchtigkeitsverlusts verhindert, entzündungshemmend für den Gebrauch nach Sonneneinstrahlung, nahrhaft und regenerierend. Dank seines Gehalts an Tocopherol besitzt es eine große anti-oxidierende Wirkung, auch in der Tiefe, bei Ernährungsmangel der Haut. Ideal für Haar und Fingernägel, da es ihnen Glanz gibt und sie durch seine hohe Nährwertkapazität stärkt.

*Contiene antiossidanti come la vitamina E ed è ricco di acidi grassi. Rigenera e rassoda i tessuti in quanto rinforza le fibre di collagene ed elastina, migliora la barriera cutanea permettendo la riduzione della perdita di idratazione, antinfiammatorio da utilizzare dopo l'esposizione al sole, nutriente e rigenerante. Grazie al suo contenuto di tocoferoli, ha un grande potere antiossidante, agendo in profondità sulla denutrizione della pelle. Ideale per capelli e unghie in quanto dona loro lucentezza e li rinforza grazie alla sua elevata capacità nutritiva.*



1 L

REF.06040

**Körperpeeling**  
**Esfoliante per il corpo**1  
u.m.vta20  
box**Arganöl und Aprikosenkern**

Peeling, angereichert mit Arganöl, das für Hydratation sorgt, und mit Aprikosenkern, das einen Peeling-Effekt erzeugt und abgestorbene Zellen sowie angesammelte Unreinheiten entfernt. Die Verwendung des Körperpeelings hilft, die abgestorbenen Hautzellen zu beseitigen, die sich trotz der Reinigung ansammeln und so die richtige Sauerstoffzufuhr verhindern. Lindert Haut, die glänzender erscheint, und bereitet sie für die spezifischen Behandlungen vor, deren Wirkstoffe nach dem Peeling besser eindringen. Angenehmes Fruchtaroma.

Kann wegen der natürlichen und milden Eigenschaften des Aprikosenkerns als übliches Körperpeeling genutzt werden. Nicht für empfindliche Haut geeignet  
Neue verbesserte Formel

**Olio di Argan e nocciolo di albicocca**

*Esfoliante arricchito con olio di argan che fornisce idratazione e nocciolo di albicocca che ha un effetto esfoliante, eliminando le cellule morte e le impurità accumulate. L'utilizzo dello scrub per il corpo aiuta a rimuovere le cellule morte della pelle che si accumulano nonostante la pulizia, impedendone la corretta ossigenazione. Ammorbidisce la pelle, che appare più liscia e luminosa, preparandola a ricevere trattamenti specifici i cui principi attivi penetreranno meglio dopo l'esfoliazione. Piacevole aroma fruttato.*

*Può essere usato come un normale scrub per il corpo grazie alle proprietà naturali e delicate del nocciolo di albicocca. Non adatto a pelli sensibili  
Nuova formula migliorata*



250 ml

REF.06648

**Kit Körper- und Gesichtspeeling mit Gummischaum als Geschenk**  
**Kit esfoliante per corpo e viso con spugna in omaggio**1  
u.m.vta12  
box

REF.04883

Enthält:  
Include:REF.06071  
REF.06648  
REF.04590

**Antizellulitische Wärmeeffekt**  
**Crema anticellulite effeto calore**

 1 u.m.vta  
 25 box

250 ml

REF.03546

 1 u.m.vta  
 12 box

500 ml

REF.03547

**Festigende remodelierende Wirkung**  
**Rassodante e rimodellante**

 1 u.m.vta  
 20 box

250 ml

REF.03932

 1 u.m.vta  
 5 box

500 ml

REF.03931

**Salze vom Toten Meer, Aloe vera und Arganöl**

Die passende Kombination aus so kräftigen Meeresalgen wie u.a. die LAMINARIA und der FUCUS ermöglichen es, zusammen mit dem Ruscus, dem jodierten Extensin oder dem Koffein, Fettansammlungen (Lypolyse) abzubauen und zu mobilisieren. Die Anregung des Kreislaufs und die lokale Erhöhung der Temperatur schaffen die erforderlichen Voraussetzungen für diesen Prozess und machen diese Creme zu einem idealen Produkt für die Behandlung der Cellulite und dem Volumen. Das Argan- und das Aloe-vera-Öl besitzen restrukturierende und regenerierende Eigenschaften.

**WÄRMEEFFEKT.** Besonders in den problematischsten Bereichen (Gesäß, Hüften, Schenkel usw.) einmassieren und einwirken lassen. Beugt auch gegen die sogenannte "Orangenhaut" vor. Aktiviert die Mikrozirkulation. Nicht für empfindliche Haut empfohlen.

**Sali del Mar Morto, aloe vera e olio di argan**

L'adeguata combinazione di alghe marine potenti come la LAMINARIA e il FUCUS insieme al ruscus, la estensina iodata o la caffeina, tra gli altri, consente di diminuire e sciogliere l'accumulo di grasso (lipolisi). L'attivazione della circolazione e l'innalzamento locale della temperatura creano le condizioni necessarie per lo sviluppo di questi processi, rendendo questa crema un prodotto ideale per il trattamento della cellulite e del volume. L'olio di argan e aloe vera hanno proprietà ristrutturanti e rigeneranti.

**EFFETTO CALORE** Massaggiare concentrandosi soprattutto sulle zone più problematiche (glutei, fianchi, cosce, ecc.). Previene anche la cosiddetta "pelle a buccia d'arancia". Attiva la microcircolazione. Non consigliata per pelli sensibili.

**Extrakt aus Zitrone, Kollagen und Algen**

Festigende remodelierende Creme, die die Haut festigt, die Zellaktivität stimuliert sowie die Elastizität und die Festigkeit verbessert. Hilft bei der Entfernung von Giftstoffen und remodeliert die Figur. An den problematischsten Stellen einmassieren und einwirken lassen.

**Estratto di limone, collagene e alghe**

Crema rassodante-rimodellante che rassoda la pelle stimolando l'attività cellulare e migliora l'elasticità e la compattezza. Aiuta ad eliminare le tossine e rimodella la figura. Massaggiare concentrandosi sulle zone più problematiche.

**Salze vom Toten Meer, Algen und Zitronenextrakt**  
**Sali del Mar Morto, alghe ed estratto di limone**

Für Behandlungen zur Reduzierung des Aussehens und der Intensität der Cellulite oder "Orangenhaut" verfügen wir über festigende, belebende und reduzierende Behandlungen. Alle mit natürlichen Produkten wie Salzen vom Toten Meer, Algen oder Zitronenextrakt. Mit Hilfe von kreisenden Massagen in den problematischsten Bereichen tragen wir zur Absorption des Produkts bei.

Per i trattamenti che aiutano a ridurre l'aspetto e l'intensità della cellulite o della pelle a "buccia d'arancia", abbiamo trattamenti rassodanti, tonificanti e riducenti. Tutti con prodotti naturali come sali del mar morto, alghe o estratto di limone. Con l'ausilio di massaggi circolari nelle zone più problematiche aiuteremo l'assorbimento del prodotto.



## Arganöl + Aloe vera

### Olio di argan + Aloe vera



Arganöl dringt schnell in die Haut ein und hydratisiert sie und ohne Fettüberschuss. Der Baum der Argania Spinosa, der nur im Südwesten Marokkos wächst, ist aufgrund seiner Eigenschaften ein einzigartiger Baum auf der Welt. Das Öl wird ohne Verwendung von chemischen Produkten entnommen, es ist ein biologisches Produkt mit nachgewiesenen Vorteilen. Die durchgeführten chemischen Analysen bestätigen seine wertvollen dermatologischen Eigenschaften, und die Kombination mit der Aloe vera bewirkt, dass die heilende und regenerative Wirkung verstärkt wird.

*L'olio di Argan penetra rapidamente nella pelle lasciandola idratata e priva di sebo in eccesso. L'albero di Argania Spinosa, che cresce solo nel sud-ovest del Marocco, è per le sue caratteristiche un albero unico al mondo. L'olio viene estratto senza alcun utilizzo di sostanze chimiche ed è un prodotto biologico dai benefici comprovati. Le analisi chimiche effettuate confermano le sue preziose proprietà dermatologiche e la combinazione con l'aloe vera potenzia gli effetti cicatrizzanti e rigenerativi.*

## Lotion feuchtigkeitsspendende Body Milk

### Lozione idratante body milk

#### Arganöl und Aloe vera

Ihre Zusammensetzung, die reich an Arganöl und Aloe vera ist, sorgt für Sanftheit, Hydratation und ein große Regenerationskraft für die Haut. Stärkt den Hydro-Lipid-Mantel und bereitet die Haut auf den alltäglichen Stress vor, so dass die ständige Verwendung der Lotion hilft, Schläffheit und Anzeichen des Alterns zu regulieren und zu verhindern. Wird schnell absorbiert. Besonders indiziert für trockene Haut.

#### Olio di argan e aloe vera

La sua composizione ricca di olio di argan e aloe vera dona morbidezza, idratazione e un grande potere rigenerante alla pelle, rinforzando il mantello idrolipidico e preparandola allo stress quotidiano, in modo che il suo uso continuato aiuti a regolare ed evitare la comparsa di flaccidità. e segni di invecchiamento. Rapido assorbimento. Particolarmente adatto per pelli secche.



1 u.m.vta  
9 box  
800 ml

REF.04459



1 u.m.vta  
8 box  
400 ml

REF.04458

## Schwamm für Körperschlamm

### Spugna corpo per fanghi

1  
u.m.vta

12  
box

» Klein  
» Piccola

REF.03169

» Groß  
» Grande

REF.03170



- » Speziell zur Entfernung der Reste von Schlammbehandlungen
- » Trocknen und härten aus, um die Entstehung von Keimen zu verhindern
- » Außergewöhnliche Sanftheit und Haltbarkeit

- » Speciale per rimuovere i fanghi
- » Si seccano e induriscono per prevenire la formazione di germi
- » Morbidezza straordinaria e di lunga durata

## Vibrierender Massagestab mit roter Lampe MEDISANA

### Massaggiatore a luce rossa MEDISANA

1  
u.m.vta

4  
box

- » Angenehme Massage durch Vibration
- » Möglichkeit der Konfiguration verschiedener Massage-Winkel
- » Enthält 5 austauschbare Massage-Zubehör
- » Die rote Lampe und die Wärme können ebenfalls angeschlossen werden
- » 2 verstellbare Niveaus der Massageintensität
- » Praktisches Design für eine bequeme Selbstmassage

- » *Piacevole massaggio vibratorio*
- » *Possibilità di impostare diversi angoli di massaggio*
- » *Include 5 accessori per massaggi intercambiabili*
- » *È possibile collegare anche luce rossa e calore*
- » *2 livelli di intensità di massaggio regolabili*
- » *Design pratico per un comodo automassaggio*



## Behandlungsflüssigkeit kalte Binden

### Liquido per i bendaggi a freddo



1 L

REF.07012

ENTSPANNEND – ERFRISCHEND – ENTLASTEND – ANTIZELLULITIKUM  
Von reduzierender Wirkung. Pflanzliche und hypothermische Wirkstoffe,  
KONZENTRAT 1 x 3

Mischung: 1 Teil Flüssigkeit kalte Binden + 3 Teile Wasser  
Kosmetische Lotion mit pflanzlichen Wirkstoffen (Seetang, Efeu,  
Stechpalme) und hypothermische Wirkstoffe, die ein lokales Abkühlen  
der Temperatur in dem behandelten Bereich für einen kontrollierten  
Zeitraum erzeugen.

#### GEBRAUCHSANLEITUNG:

Einen Teil der Lotion mit 3 Teilen Wasser mischen und die Binden in  
der Mischung aufweichen und damit den zu behandelnden Bereich  
einwickeln. 30 bis 45 Minuten einwirken lassen und etwa 2 Stunden lang  
nicht duschen. Zwei- oder dreimal in der Woche verwenden.

RILASSANTE - RINFRESCANTE - DECONGESTIONANTE - ANTI-CELLULITE ad  
azione

riduttrice. Principi attivi vegetali e ipotermici CONCENTRATO 1 x 3

Miscela: 1 parte di liquido per bendaggio freddo + 3 parti di acqua

Lozione cosmetica con principi attivi vegetali (fucus, edera, aquifolium) e  
ipotermici che producono un raffreddamento locale della temperatura nella  
zona trattata per un tempo controllato.

#### COME USARE:

Mescolare una parte della lozione con 3 parti di acqua e immergere le bende  
nella miscela, avvolgendole poi intorno alla zona da trattare. Tenere da 30  
a 45 minuti e non fare la doccia per circa 2 ore. Usare due o tre volte a  
settimana.



## Rolle kalte Binden 15x10 Krepp

### Rotolo per bendaggi freddi 15x10 crepe



REF.07108



Hergestellt aus dickem und elastischem Kreppstoff  
für Behandlungen mit kalten Binden und  
Kompressionsbehandlungen. Tränken Sie die Binden in die  
Flüssigkeit für kalte Binden (07012), um u.a. eine antizellulitische,  
entzündungshemmende Behandlung zu erzielen

Realizzato in tessuto crepe spesso ed elastico per trattamenti di  
bendaggio a freddo e trattamenti di compressione. Immergere le  
bende nel liquido per bendaggi freddi (07012) per effettuare un  
trattamento anticellulite, antinfiammatorio, ecc.

## Rolle kalte Binden 15x10 Krepp

### Rotolo per bendaggi freddi 10x10 crepe



REF.03041



Elastische Binde, sowohl längs als auch quer einsetzbar.  
Zusammensetzung: Baumwolle: 93,84%, beschichtetes  
Elastomer: 6,2%. Höhere Qualität. Binde mit Kette, an den  
Seiten geflochten, ideal für Körperbehandlungen

Bendaggio elastico sia longitudinale che trasversale.  
Composizione: cotone: 93,84%, elastomero rivestito: 6,2%.  
Qualità superiore. Benda a bordo intrecciato sui lati, ideale per  
trattamenti corporali

### Fausthandschuh aus Baumwolle Guanto in cotone

12  
u.m.vta

96  
box



REF.01916



### Fausthandschuh mit Naturborsten Guanto in crine di cavallo

1  
u.m.vta

20  
box

REF. 01084



### FarGrandeer Schwamm aus Gummi für Bad/Massage Spugna colorata in gomma per bagno/massaggio

» Groß  
» Grande

1  
u.m.vta

16  
box



REF. 04591



» Klein  
» Piccolo

1  
u.m.vta

24  
box



REF. 04590



### Holzbürste für das Bad Spazzola in legno

» Naturfaser. Griff aus Holz  
» Fibra naturale. Manico in legno

1  
u.m.vta

12  
box

REF. 00526



### FarGrandeer Bürste für das Bad Spazzola colorata

» Nylon-Borsten  
» Setole in nylon

1  
u.m.vta

15  
box

REF. 00679



03

# Haarentfernung

DEPILAZIONE

*Wachs kg, Wachs Roll-on, Wachsschmelzer,  
Zubehör, Enthaarungspinzetten...*

*Cera a kg, cera roll-on, scaldacera, acces-  
sori, pinzette...*



**Beutel 1 kg Wachsscheiben**  
**Confezione di dischi di cera da 1 Kg**

Die Haarentfernung mit niedrig schmelzendem Wachs ist sehr effektiv beim Körperhaar. Seine spezielle Formel auf der Grundlage von natürlichem Bienenwachs und Kolophonien von höchster Qualität bereitet die Haut vor? Und macht die Poren weicher. Seine Anhaftung ist vollständig, so dass es das Körperhaar von der Wurzel her entfernt, was das Neuwachstum verzögert. Um eine elastische und cremige Konsistenz bei Raumtemperatur zu erhalten, werden einige unserer Wachse mit Titandioxid verarbeitet. Auf diese Weise erreichen wir einen niedrigeren Schmelzpunkt, was die Haarentfernung begünstigt. Kombinierbare skalierte Preise ab 6 Stück mit allen Referenzen auf Seite 557.

*La ceretta a basso punto di fusione è molto efficace nella rimozione dei peli. La speciale formula a base di cera d'api naturale e colofonia di alta qualità, prepara la pelle ammorbidendone i pori. La sua aderenza è totale quindi estrae i peli alla radice, ritardandone la ricomparsa. Per ottenere una consistenza cremosa ed elastica a temperatura ambiente, alcune delle nostre cere sono realizzate con biossido di titanio. In questo modo, otteniamo un punto di fusione più basso che favorisce la depilazione. Prezzi scalabili cumulabili a partire dal box di 6 unità con tutte le referenze a pagina 557.*



1 kg

REF. 04675

- » Wachsscheiben **Brasilian**
- » Bidirektional
- » Extra flexibel
- » Keine Papierstreifen erforderlich

- » Dischi di cera **Brasilian**
- » Bidirezionale
- » Extra flessibile
- » Non ha bisogno di strisce di carta

- » Honig
- » Miele

1 kg

REF. 03916



- » Empfindliche Haut mit Titandioxid
- » Per pelli sensibili con biossido di titanio

1 kg

REF. 03917



- » Aloe Vera
- » Aloe Vera

1 kg

REF. 03918



- » Arganöl
- » Olio di Argan

1 kg

REF. 03919



- » Kakao
- » Cacao

1 kg

REF. 03920



- » Azulen
- » Azulene

1 kg

REF. 04260



**Beutel 1 kg Wachs made in Spain**  
Confezione da 1 kg di cera prodotta in Spagna

Bereiche der Behandlung: Achseln, Brust, Rücken, Arme, Bauch, Beine, Gesicht und Leisten (Roll-on für das Gesicht). Wählen Sie dasjenige aus, das am besten für Ihren Typ von Körperhaar und Haut passt: transparent, ultra-cremig, farGrande, parfümiert, niedrige Schmelze, usw. Skalierter Preis, kombinierbar mit einer der Referenzen auf Seite 558-559.

Area di trattamento: inguine, ascelle, braccia, labbro superiore, viso, corpo. Scegli quella che meglio si adatta in funzione dell'elasticità, del tipo di pelo e di pelle: trasparenti, elastiche, colorate, profumate, a basso punto di fusione, ecc.  
Prezzo scalato cumulabile con qualsiasi riferimento a pagina 558-559.

**Wachspastillen rosa - doppelt höhere Elastizität**  
**Compresse di cera rosa - doppia elasticità superiore**

Flexibel, ermöglichen sie das Auftragen einer feinen Schicht, die das Wärmegefühl reduziert. Das klassische Wachs, speziell für die Enthaarung von Leisten und Achseln.

*Flessibili, consentono di applicare uno strato sottile riducendo la sensazione di calore. Cera classica, soprattutto per la ceretta all'inguine e alle ascelle.*



1 kg

REF.06323

**Wachspastillen grün - Elastizität**  
**Compresse di cera verde - elasticità normale**

Transparent oder semitransparent, mit flüssiger Textur, kräftige Wirkung und rasches Trocknen. Leicht und kristallin, geeignet für jeden Bereich des Körpers.

*Trasparente o semitrasparente, di consistenza fluida, tiraggio forte e asciugatura rapida. Leggera e cristallina, adatta a qualsiasi zona del corpo.*



1 kg

REF.06324

**Wachspastillen blau - höhere Elastizität**  
**Compresse di cera blu - elasticità superiore**

Transparent oder semitransparent, mit flüssiger Textur, kräftige Wirkung und rasches Trocknen. Leicht und kristallin, geeignet für jeden Bereich des Körpers.

*Trasparente o semitrasparente, di consistenza fluida, tiraggio forte e asciugatura rapida. Leggera e cristallina, adatta a qualsiasi zona del corpo.*



1 kg

REF.06325

**Beutel 1 kg Wachs made in Spain**  
Confezione da 1 kg di cera prodotta in Spagna

Bereich der Behandlung: Leisten, Achseln, Arme, Oberlippe, Gesicht, Körper. Wählen Sie dasjenige aus, das am besten für Ihren Typ von Körperhaar und Haut passt: transparent, elastisch, farGrande, parfümiert, niedrige Schmelze, usw.  
Skalierter Preis, kombinierbar mit einer der Referenzen auf Seite 558-559.

Area di trattamento: inguine, ascelle, braccia, labbro superiore, viso, corpo. Scegli quella che meglio si adatta in funzione dell'elasticità, del tipo di pelo e di pelle: trasparenti, elastiche, colorate, profumate, a basso punto di fusione ecc.  
Prezzo scalato cumulabile con qualsiasi riferimento a pagina 558-559.

**Wachspastillen Schokolade – dreifach höhere Elastizität**  
**Comprese di cera cioccolato - tripla elasticità superiore**

Flexibel und elastisch, begünstigen die Anwendung und Entfernung auf sanfte und wenig aggressive Weise für die Haut. Sorgt für eine sanfte Haarentfernung, wobei die Haut leicht parfümiert wird.

*Flessibili ed elastiche, favoriscono l'applicazione e la rimozione in modo delicato e non aggressivo per la pelle. Depilazione delicata, lascia la pelle leggermente profumata.*



1 kg

REF.06328

**Wachspastillen Wein – dreifach höhere Elastizität**  
**Comprese di cera vino - tripla elasticità superiore**

Flexibel und elastisch, begünstigen die Anwendung und Entfernung auf sanfte und wenig aggressive Weise für die Haut. Von intensiver Farbe, sorgt es für eine sanfte Haarentfernung, wobei die Haut leicht parfümiert wird.

*Flessibili ed elastiche, favoriscono l'applicazione e la rimozione in modo delicato e non aggressivo per la pelle. Di colore intenso, offre una depilazione delicata, lasciando la pelle leggermente profumata.*



1 kg

REF.06327

**Wachspastillen Malve – dreifach höhere Elastizität**  
**Comprese di cera di malva - tripla elasticità superiore**

Flexibel und elastisch, begünstigen die Anwendung und Entfernung auf sanfte und wenig aggressive Weise für die Haut. Von intensiver Farbe, ist es ideal für das Körperhaar des Mannes aufgrund seiner kräftigen Wirkung.

*Flessibili ed elastiche, favoriscono l'applicazione e la rimozione in modo delicato e non aggressivo per la pelle. Di colore intenso, ideali per i peli maschili grazie al loro grande potere di tiraggio.*



1 kg

REF.06326



**Box 20 Wachsscheiben**  
**Scatola da 20 dischi di cera**

Die Haarentfernung mit niedrig schmelzendem Wachs ist sehr effektiv beim Körperhaar. Seine spezielle Formel auf der Grundlage von natürlichem Bienenwachs und Kolophonien von höchster Qualität bereitet die Haut vor? Und macht die Poren weicher. Seine Anhaftung ist vollständig, so dass es das Körperhaar von der Wurzel her entfernt, was das Neuwachstum verzögert. Um eine elastische und cremige Konsistenz bei Raumtemperatur zu erhalten, werden einige unserer Wachse mit Titandioxid verarbeitet. Auf diese Weise erreichen wir einen niedrigeren Schmelzpunkt, was die Haarentfernung begünstigt. Gestaffelte Preise, kombinierbar mit Seite 560.

*La ceretta a basso punto di fusione è molto efficace nella rimozione dei peli. La speciale formula a base di cera d'api naturale e colofonia di alta qualità, prepara la pelle ammorbidendone i pori. La sua aderenza è totale quindi estrae i peli alla radice, ritardandone la ricomparsa. Per ottenere una consistenza cremosa ed elastica a temperatura ambiente, alcune delle nostre cere sono realizzate con biossido di titanio. In questo modo, otteniamo un punto di fusione più basso che favorisce la depilazione. Prezzo scalato cumulabile con pagina 560.*

400 gr

REF. 04070

» Aloe vera  
» Aloe vera

400 gr

REF. 04071

» Honig  
» Miele

400 gr

REF. 04072

» Empfindliche Haut  
» Pelle sensibile

**Wachs-Tablett**  
Cera in vassoio» Honig  
» Miele

500 gr

REF. 03722

» Chlorophyll  
» Clorofilla

500 gr

REF. 03726

**Wachsdose**  
Cera in barattolo

400 gr

Empfindliche Haut  
Pelle sensibile

REF.04563

400 gr

Honig  
Miele

REF.03728

400 gr

Aloe vera  
Aloe Vera

REF.04735



800 gr

Empfindliche Haut  
Pelle sensibile

REF.04565

800 gr

Honig  
Miele

REF.04564

800 gr

Aloe Vera  
Aloe Vera

REF.04736



## Wachsschmelzer Scaldacera

- » Leistung: 80 W
- » Mit Thermostat
- » Ohne Kasserolle
- » Geeignet für Dosen von 400 und 500 g

- » Potenza: 80W.
- » Con termostato
- » Senza recipiente
- » Adatto per lattine da 400 e 500 g



400 gr

REF. 03321



### Ersatzteil Ricambi

400 gr

REF. RE03321/02



- » Leistung: 80 W
- » Mit Thermostat
- » Enthält Kasserolle von 800 g
- » Rasche Erwärmung des Wachses
- » Sicher und ergonomisch
- » Leicht und von kleinen Dimensionen
- » Für Scheiben, Wachs oder Perlen, Kasserolle verwenden

- » Potenza: 80W.
- » Con termostato
- » Include recipiente da 800 g
- » Rapido riscaldamento della cera
- » Sicuro ed ergonomico
- » Leggero e compatto
- » Per dischi, cera o perle, usare recipiente



800 gr

REF. 03322

### Ersatzteil Ricambi

800 gr

REF. RE03322/01



## Wachsschmelzer Scaldacera

- » Leistung: 80 W
- » Mit Thermostat
- » Mit Kasserolle von 450 g inbegriffen

- » Potenza: 80W.
- » Con termostato
- » Con recipiente da 450 g incluso



450 gr

REF. 03154



## Schutzfolien Wachsschmelzer Protezione per scaldacera

- » Beutel 100 kreisförmige Schutzfolien für Wachsschmelzer
- » Innendurchmesser: 9,8cm
- » Außendurchmesser: 16cm
- » Maximaler Innendurchmesser: 13,5cm

- » Confezione da 100 cerchi protettivi per scaldacera
- » Diametro interno: 9,8cm
- » Diametro esterno: 16cm
- » Diametro interno massimo: 13,5cm

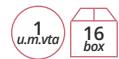

REF. 03716



## Wachsschmelzer Scaldacera



- » Leistung: 90 W
- » Elektronischer Temperatur-Thermostat
- » Ablage aus Aluminium
- » Rasche Erwärmung des Waxes
- » Sicher und ergonomisch
- » Leicht und von kleinen Dimensionen
- » Kasserolle mit ausziehbarem Griff  
inbegriffen

- » Potenza: 90W.
- » Termostato elettronico di temperatura
- » Serbatoio in alluminio
- » Rapido riscaldamento della cera
- » Sicuro ed ergonomico
- » Leggero e compatto
- » Recipiente estraibile incluso con manico

## Ersatzteil Ricambi



250 gr

REF. RE03612/01



250 gr

REF. 03612



## Wachsschmelzer Pollié Scaldacera Pollié



- » Leistung: 40 W
- » Wachsschmelzer 125 ml. Kompakt, ideal für die  
Haarentfernung von kleinen Bereichen wie Nase,  
Ohren, Augenbrauen und Bartkontur

- » Potenza: 40W.
- » Scaldacera 125 ml. Compatta, ideale per ceretta su piccole  
zone come naso, orecchie, sopracciglia e contorno barba

125 gr

REF. 06614/58

125 gr

REF. 06614/70



## Ersatzteil · Ricambi

- » Kasserolle Wachs für wachsschmelzer
- » Ref.-Nr. 06614/58, 06614/70 und 04505

- » Recipiente per cera per scaldera
- » rif. 06614/58, 06614/70 e 04505



125 gr

REF. RE06614/01

### Wachsschmelzer mit Thermostat aus Metall Scaldacera con termostato in metallo

Ideal zur Verwendung mit Wachsscheiben oder Pastillen  
Ideale per l'uso con dischi o pastiglie in cera



- » Leistung: 125W
- » Mit Filter

- » Potenza: 125W.
- » Con filtro

- » Leistung: 125W
- » Mit Filter
- » Geeignet für Dosen von 400 und 500 g

- » Potenza: 125W.
- » Con filtro
- » Adatto per barattoli da 400 e 500 g



250 gr

REF. 02905



400 kg

REF. 02928

- » Leistung: 250 W
- » Mit Filter

- » Potenza: 250W.
- » Con filtro



1 kg

REF. 02908

- » Leistung: 450 W
- » Mit Filter

- » Potenza: 450W.
- » Con filtro



4 kg

REF. 02900

Wachsschmelzer mit 2 miteinander verbundenen Behältern und mit Filter zum Filtern von wiederverwendbarem Wachs. Enthält 2 unabhängige Thermostate, einen für jeden Behälter

Scaldacera con 2 contenitori collegati e filtro per filtrare la cera riutilizzabile. Contiene 2 termostati indipendenti per ogni contenitore

## GROSSE SCHMELZER FUSORI GRANDI

### Wachsschmelzer mit Thermostat aus Metall Scaldacera con termostato in metallo

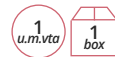

» Leistung: 2 x 450 W  
» Mit Filter

» Potenza: 2 x 450W  
» Con filtro



8 kg

REF. 02906

» Leistung: 2 x 450 W  
» Mit Filter

» Potenza: 2 x 450W  
» Con filtro



12 kg

REF. 04216

» Leistung: 2 x 450 W  
» Mit Filter

» Potenza: 2 x 450W  
» Con filtro



20 kg

REF. 04217

## Wachsspachtel Holz

### Spatola per cera in legno

 12  
u.m.vta  
12  
box

 » Mini  
» Mini

REF.01627

 » Klein  
» Piccola

REF.01628

 » Mittel  
» Media

REF.01630

 » Groß  
» Grande

REF.01632

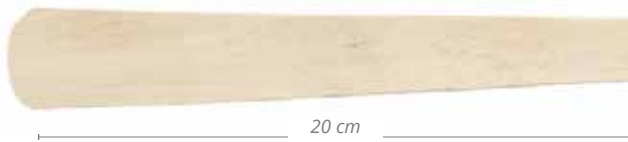
 » Super-groß  
» Extra grande

REF.01634

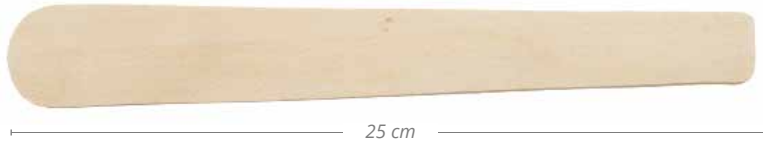

## Box 100 Spachteln aus Holz

### Scatola da 100 spatole in legno

 1  
u.m.vta  
50  
box

REF.07114

## Beutel 100 Spachteln aus Holz

### Sacchetto da 100 spatole in legno

 1  
u.m.vta  
100  
box

REF.06651

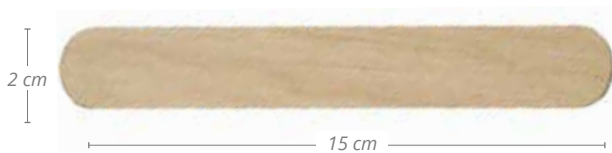

 1  
u.m.vta  
50  
box

REF.03282



**Pack 100 Wachspachteln spezial**  
 Confezione da 100 spatole speciali per cera



REF.01636



**Wachspachtel mit Griff**  
 Spatola per cera con manico



REF.01629



REF.01631



REF.01633

**Spachtel Extra Flex aus Kunststoff**  
 Spatola Extra Flex in plastica



Farbe weiß. Material Hartplastik für Wachs oder jede Art von Schönheitsbehandlung, bei der es benötigt wird  
 Colore bianco. Materiale plastico rigido per cera o qualsiasi tipo di trattamento estetico che lo richieda

REF.03229

REF.03230



**Wachspachtel aus Metall/Holz**  
 Spatola per cera in legno/metallo



REF.03469

REF.01419





## Wachs-Roll-on made in Spain

### Roll-on con cera prodotta in Spagna



Bereiche der Behandlung: Achseln, Brust, Rücken, Arme, Bauch, Beine, Gesicht und Leisten (Roll-on für das Gesicht). Wählen Sie dasjenige aus, das am besten für Ihren Typ von Körperhaaren und Haut passt: transparent, ultra-cremig, farGrande, parfümiert usw. Gestaffelte Preise, kombinierbar. Seite 568.

Area di trattamento: ascelle, petto, schiena, braccia, addome, gambe, viso e inguine (roll-on facciale). Scegli quello più adatto al tipo di peli e pelle: trasparente, ultra cremoso, colorato, profumato, ecc. Prezzi scalati combinabili pagina 568.



### Naturwachs-Roll-on - kristallin

#### Cera roll-on naturale - cristallina

Transparent oder semitransparent, mit flüssiger Textur und kräftiger Wirkung. Seine hervorragende Kombination aus Pinienharzen machen ihn zum idealen Werkzeug für eine perfekte Haarentfernung.

Trasparente o semitrasparente, dalla consistenza fluida e con tiraggio forte. La sua eccellente combinazione di resine di pino lo rendono ideale per una perfetta depilazione.



100 ml

REF.06317

### Wachs-Roll-on blau - kristallin

#### Cera roll-on blu - cristallina

Transparent oder semitransparent, mit flüssiger Textur und kräftiger Wirkung. Geeignet für alle Stellen, selbst die empfindlichsten.

Trasparente o semitrasparente, dalla consistenza fluida e con tiraggio forte. Adatto a tutte le zone, anche quelle più sensibili.



100 ml

REF.06318

### Wachs-Roll-on rosa - cremig

#### Cera roll-on rosa - cremosa

Transparent oder semitransparent, mit flüssiger Textur und kräftiger Wirkung. Seine elastische Textur erleichtert die Haarentfernung bei jedem Typ von Körperhaar.

Cera roll-on rosa - cremosa  
Trasparente o semitrasparente, dalla consistenza fluida e con tiraggio forte. Per una depilazione per qualsiasi tipo di pelo.



100 ml

REF.06319

### Wachs-Roll-on Schokolade - cremig

#### Cera roll-on cioccolato - cremosa

Von angenehmer cremiger und elastischer Textur für einen perfekten Start. Für eine sanfte und wirkungsvolle Haarentfernung, mit einem intensiven Aroma nach Schokolade.

Gradevole consistenza cremosa ed elastica per un tiraggio perfetto. Per una depilazione delicata ed efficace, con un intenso profumo di cioccolato.



100 ml

REF.06320

### Wachs-Roll-on Gold - irisierende Pigmente

#### Cera roll-on oro - pigmenti iridescenti

Dichte Textur, die die Anhaftung begünstigt und das Wärmegefühl und den Schmerz reduziert. Dank der vergoldeten Partikel erhält das Wachs seine Temperatur, was die Anwendung und den Start erleichtert.

Consistenza densa che favorisce l'aderenza e riduce la sensazione di calore e dolore. Grazie alle particelle d'oro, la cera mantiene la sua temperatura, facilitando l'applicazione e il tiraggio.



100 ml

REF.06321

### Wachs-Roll-on Wein - cremig

#### Cera roll-on vino - cremosa

Von angenehmer cremiger und elastischer Textur, für einen perfekten Start. Für eine sanfte und wirkungsvolle Haarentfernung, wobei die Haut leicht parfümiert wird.

Gradevole consistenza cremosa ed elastica per un tiraggio perfetto. Per una depilazione delicata ed efficace che lascia la pelle leggermente profumata.



100 ml

REF.06322

## Wachs-Roll-on Cera Roll-on



Das System der Haarentfernung Roll-on ist optimal für alle Profis, die nach den besten Ergebnissen streben. Die Harze, mit denen wir die Wachse herstellen, können bei höherer Temperatur als niedrig schmelzendes Wachs verwendet werden, mit dem Vorteil, dass sie durch einen feinen Streifen aufgetragen werden. So kühlt sich das Wachs beinahe augenblicklich ab, und das Wärmegefühl auf der Haut wird minimiert. Das Wachs kann leicht mit den Hygienestreifen entfernt werden. Gestaffelte Preise, kombinierbar, Seite 569-570.

*Il sistema di depilazione roll-on è ottimale per quei professionisti che cercano di ottenere i migliori risultati. Le resine con le quali produciamo le cere possono essere utilizzate ad una temperatura più elevata rispetto alle cere a basso punto di fusione, con il vantaggio di essere applicate mediante una striscia più sottile. Così, la cera si raffredda quasi istantaneamente e la sensazione di calore sulla pelle è ridotta al minimo. La cera si rimuove facilmente con le salviette igieniche. Prezzi scalati combinabili pagina 569-570.*

Roll-on Honigwachs  
Cera roll-on miele

100 ml

REF.03704

» Wachs-Roll-on Talkum mit Titandioxid  
» Cera roll-on talco con biossido di titanio

100 ml

REF.03705



» Wachs-Roll-on aus Olivenöl  
» Cera roll-on all'olio d'oliva

100 ml

REF.03739

» Wachs-Roll-on Aloe vera  
» Cera roll-on blu - cristallina

100 ml

REF.03740



» Wachs-Roll-on für Männer  
» Cera roll-on uomo

100 ml

REF.03858

» Wachs-Roll-on Azulen  
» Cera roll-on azulene

100 ml

REF.04259



## Wachs-Roll-on Cera Roll-on



Das System der Haarentfernung Roll-on ist optimal für alle Profis, die nach den besten Ergebnissen streben. Die Harze, mit denen wir die Wachse herstellen, können bei höherer Temperatur als niedrig schmelzendes Wachs verwendet werden, mit dem Vorteil, dass sie durch einen feineren Streifen aufgetragen werden. So kühlt sich das Wachs beinahe augenblicklich ab, und das Wärmegefühl auf der Haut wird minimiert. Das Wachs kann leicht mit den Hygienestreifen entfernt werden. Gestaffelte Preise, kombinierbar, Seite 569-570.

*Il sistema di depilazione roll-on è ottimale per quei professionisti che cercano di ottenere i migliori risultati. Le resine con le quali produciamo le cere possono essere utilizzate ad una temperatura più elevata rispetto alle cere a basso punto di fusione, con il vantaggio di essere applicate mediante una striscia più sottile. Così, la cera si raffredda quasi istantaneamente e la sensazione di calore sulla pelle è ridotta al minimo. La cera si rimuove facilmente con le salviette igieniche. Prezzi scalati combinabili pagina 569-570.*

» Wachs-Roll-on Kokos  
» Cera roll-on cocco



100 ml

REF.04678



» Wachs-Roll-on Apfel  
» Cera roll-on mela



100 ml

REF.04674



» Wachs-Roll-on Banane  
» Cera roll-on banana



100 ml

REF.04677



» Wachs-Roll-on Kakao  
» Cera roll-on cacao



100 ml

REF.03748



» Wachs-Roll-on Argan  
» Cera roll-on argan



100 ml

REF.03706



» Wachs-Roll-on Rosen, empfindliche Haut, mit Titandioxid  
» Cera roll-on rosa pelli sensibili con biossido di titanio



100 ml

REF.03749



100 ml

REF.03907

» Facial  
» Facciale



### Roll-on-Heizgerät mit Außenthermostat Riscaldatore roll-on con termostato esterno



REF. 04091

- » Leistung: 20 W
- » Heizgerät mit Ladebasis für eine höhere Stabilität und Verwendung
- » Fenster zur Anzeige des Wachsneaus
- » Regulierung der Temperatur von 1 bis 6
- » Kabel des Ladegeräts 2 Meter
- » Rasche Erwärmung und niedriger Verbrauch
- » Schutzabdeckung
- » Dank seines inneren Designs passt es sich an jeden Typ von Roll-on an
- » LED-Wärmeanzeige
- » 100-240 V~

- » Potenza: 20W.
- » Riscaldatore con base per una maggiore stabilità
- » Finestrina per visualizzare il livello della cera
- » Regolazione della temperatura da 1 a 6
- » Cavo della base: 2 metri
- » Riscaldamento veloce e consumi ridotti
- » Coperchio di protezione
- » Grazie al suo design interno si adatta a qualsiasi tipo di roll-on
- » Spia LED di riscaldamento
- » 100-240V~

### Roll-on-Heizgerät mit Innenthermostat Riscaldatore roll-on con termostato interno



REF. 03379

- » Leistung: 15W
- » Heizgerät für Wachs-Roll-on mit seitlicher Anzeige des Wachsneaus
- » Ergonomisches Design
- » Erreicht rasch die optimale Temperatur
- » Dank seines Innendesigns passte es sich an jeden Typ von Roll-on an
- » Innenthermostat, der die ideale Temperatur für die Anwendung des Wachses erhält
- » LED-Betriebsanzeige
- » 100-240 V~
- » 50/60 Hz

- » Potenza: 15W.
- » Riscaldatore roll-on con visore laterale per il livello di cera
- » Design ergonomico
- » Rapido pa raggiungere la temperatura ottimale
- » Grazie al suo design interno si adatta a qualsiasi tipo di roll-on
- » Termostato interno che mantiene la temperatura ideale per l'applicazione della cera
- » Led indicatore di accensione e spegnimento
- » 100-240V~
- » 50/60Hz

### Ladegerät Roll-on-Heizgerät Ref.-Nr. 03379 Base per riscaldatore roll-on rif. 03379

Kabel: 1,6 m  
Cavo: 1,6 m

- » Leistung: 15W
- » 100-240 V~



1 roll-on

REF. 03272

- » Leistung: 30 W
- » 100-240 V~

- » Potenza: 30W.
- » 100-240V~



2 roll-on

REF. 03273

- » Leistung: 45W
- » 100-240 V~

- » Potenza: 45W.
- » 100-240V~



3 roll-on

REF. 03274



**1 Roll-on-Heizgerät + 1 Ladegerät mit magnetische Basis**  
**1 riscaldatore roll-on + 1 base di ricarica con base magnetica**



100 ml

REF. 06623



- » Leistung: 20 W
- » Fassungsvermögen: 100 g
- » Frequenz: 50 Hz
- » Spannung: 220-240 V~
- » Ladegerät anschließbar an andere Ladegeräte (bis zu 5 Geräte)
- » Seitliches Fenster zur Anzeige des Wachs-niveaus
- » Kontrollregler für die Temperatur (85°C máx)
- » Leicht und von kleinen Abmessungen
- » Mit Schutzkappe

- » Potenza: 20W.
- » Capacità: 100 gr
- » Frequenza: 50Hz
- » Voltaggio: 220-240V~
- » Base collegabile ad altre basi (fino a 5 basi)
- » Finestrina laterale per vedere il livello della cera
- » Controllo del regolatore di temperatura (85°C max)
- » Leggero e compatto
- » Con cappuccio protettivo



## Haarentfernung-Kits Pollié

### Kit per la depilazione Pollié

Die Haarentfernung-Kits Pollié sind ideal für eine einfache und bequeme Haarentfernung mit allem Notwendigen für die professionelle Depilation zu Hause. Zeigen Sie das ganze Jahr über schöne Beine.

*I kit per la depilazione Pollié sono ideali per una depilazione facile e confortevole con tutto il necessario per la depilazione professionale a casa. Sfoggia delle belle gambe durante tutto l'anno.*



100 ml

REF.03310

#### Enthält · Contiene

REF. 03379

» 1 Roll-on-Heizgerät  
15W» 1 riscaldatore roll-on  
15W

REF. 03706

» 1 Roll-on Argan

» 1 roll-on di argan



REF. 02091

» 1 Pack mit 20  
Haarentfernungstreifen» 1 confezione da 20 strisce  
depilatorie

REF. 03855/01

» 3 Beutel mit 5 Öl-  
Pflegetücher Post-  
Haarentfernung» 3 pacchetti da 5  
salviettine con olio  
post-depilazione

100 ml

REF.03925

#### Enthält · Contiene

REF. 04091

» 1 Roll-on-  
Heizgerät 20 W» 1 riscaldatore roll-  
on 15W

REF. 03706

» 1 Roll-on Argan

» 1 roll-on di argan



REF. 02091

» 1 Pack mit 20  
Haarentfernungstreifen» 1 confezione da 20 strisce  
depilatorie

REF. 03855/01

» 3 Beutel mit 5  
Öl-Pflegetücher Post-  
Haarentfernung» 3 pacchetti da 5  
salviettine con olio  
post-depilazione



### Packs Papierstreifen zur Haarentfernung POLLIÉ Pacchetti di strisce di carta depilatoria POLLIÉ

» 20 Streifen  
» 20 strisce



85 g/m<sup>2</sup>

REF.02091

» 100 Streifen  
» 100 strisce



80 g/m<sup>2</sup>

REF. 00929

» 100 Streifen  
» Extra stark



90 g/m<sup>2</sup>

REF. 02556



» 100 Streifen  
» 100 strisce



80 g/m<sup>2</sup>

REF. 04207

» 100 Streifen  
» 100 strisce



80 g/m<sup>2</sup>

REF. 03804



### Rolle Haarentfernungspapier Rotolo di carta depilatoria

» Breite; 7 cm  
» Länge: 75 m

80 g/m<sup>2</sup>

REF. 06926

» Larghezza: 7 cm  
» Lunghezza: 75 m

» Breite; 7 cm  
» Länge: 100 m

80 g/m<sup>2</sup>

REF. 03806

» Larghezza: 7 cm  
» Lunghezza: 100 m



## Pack Papierstreifen zur Haarentfernung ANÓNIMAS

### Pacchetti di strisce di carta depilatoria

» 100 Streifen  
» 100 strisce



80 g/m<sup>2</sup>

REF. 00929/00

» 100 Streifen  
» Extra stark



90 g/m<sup>2</sup>

REF. 02556/00

» 10 Streifen  
» 10 strisce



80 g/m<sup>2</sup>

REF. 03805

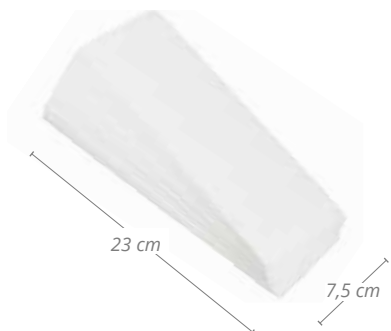

## Box mit 100 Papierstreifen zur Haarentfernung 90 Gramm hypoallergen

### Confezione da 100 strisce di carta depilatoria 90 grammi ipoallergenica



Eng geflochtene Fasern, die dem Produkt eine hohe Reißfestigkeit verleihen und als Barriere wirken, damit das Wachs nicht durchdringt

*Fibre strettamente intrecciate che conferiscono al prodotto una totale resistenza allo strappo e fanno da barriera affinché la cera non penetri*

» Extra: da es eine höhere Dichte besitzt, ist es stärker und widerstandsfähiger

» Extra: avendo più densità è più forte e più resistente

90 g/m<sup>2</sup>

REF. 06114





### Gel Post-Haarentfernung Gel post depilazione

- » 99% aloe vera
- » 99% di aloe vera



500 ml

REF.03613



### Öl Post-Haarentfernung Olio post depilazione

- » Mit Weinrose
- » Rosenduft
- » Con rosa mosqueta
- » Profumo di rosa



500 ml

REF.03614



### Öl-Pflegetücher Post-Haarentfernung Salviette con olio post depilazione

- » Beutel mit 5 Pflegetüchern
- » Pacchetto da 5 salviette



2 ml

REF.03855

- » Unverpackt
- » Sfuso



2 ml

REF.03855/01

### Box 20 Kaltwachs-Streifen EMPFINDLICHE HAUT Scatola da 20 strisce di cera fredda PELLI SENSIBILI

- » Enthaarungsstreifen für den Körper
- » Strisce per il corpo



REF.03717

- » Enthaarungsstreifen für das Gesicht
- » Strisce per il viso



REF.03718



Mit Beerenfrucht-Extrakten  
Con estratti di frutti rossi

## Box 50 konische Nadeln zur Haarentfernung

### Confezione da 50 aghi conici per depilazione



0,5 mm | Inox

REF.02965

1 mm | Inox

REF.02966

1,5 mm | Inox

REF.02967

0,5 mm | Oro-Gold

REF.02968

1 mm | Oro-Gold

REF.02969

1,5 mm | Oro-Gold

REF.02970



## Haarentfernungsnadeln schräg

### Aghi per depil. Inclinati

» Box 50 Nadeln

» Confezione 50 aghi



1 mm | Inox

REF.03287



## Gerätereiniger aus Wachs

### Detergente per apparecchi depilatori



» Lösungsmittel in Sprayform  
 » Für Schmelzer und Heizgeräte

500 ml

REF. 03437

» Solvente spray  
 » Per scaldacera e riscaldatori



## Stromleitendes Gel neutral

### Gel elettroconduttivo neutro



Das Ultraschall-Übertragungsgel TASSEL ist zur Verbesserung der Leitfähigkeit für diagnostische und therapeutische Ultraschalluntersuchungen indiziert. Es ist im Wasser löslich und hinterlässt keine Flecken. Es kann mit allen auf dem Markt verfügbaren Ultraschallgeräten verwendet werden. Es ist einfach aufzutragen, gleichmäßig und ohne zu trocknen.

Das Ultraschall-Übertragungsgel TASSEL ist für den externen Gebrauch auf die intakte Haut und ohne Hautverletzungen gedacht. Tragen Sie das Gel an der zu behandelnden Stelle auf. Es ist ein hervorragendes Leitmittel für die Ultraschalltherapie, Diagnosebilder und die Laser-Haarentfernung.

*Il gel per la trasmissione degli ultrasuoni TASSEL è indicato per migliorare la conduttività per gli ultrasuoni diagnostici e terapeutici. È solubile in acqua, non lascia macchie. Può essere utilizzato con tutti i dispositivi ad ultrasuoni disponibili sul mercato. Si stende facilmente, in modo uniforme e senza seccare.*

*Il gel per la trasmissione degli ultrasuoni TASSEL è destinato all'uso esterno su pelle intatta senza ferite cutanee. Applicare il gel sulla zona da trattare. È un eccellente agente conduttivo per la terapia a ultrasuoni, la diagnostica per immagini e la depilazione laser.*

5 L

REF. 06694



## Talkum TASSEL

### Talco TASSEL



Extrafines parfümiertes Talkumpuder. Sanftheit, Frische und Nahrung für die Haut. Die Talkumpuder Tassel sind lindernd, feuchtigkeitsspendend und pflegend.

Ideal für nach der Rasur oder Haarentfernung, Reizungen oder wunde Stellen, Rötungen, Sonneneinwirkung oder Hautverletzungen. Ohne Allergene und ohne Parabene. Dermatologisch getestet.

- » Absorbiert die Feuchtigkeit
- » Hält die Haut frisch und trocken
- » Lindert gereizte Haut
- » Mildert

*Talco extra fine profumato. Morbidezza, freschezza e nutrimento per la pelle. Il talco Tassel è ammorbidente, idratante ed emolliente. Ideale per dopo la rasatura o la ceretta, irritazioni o prurito, arrossamenti, esposizione al sole o lesioni cutanee. Senza allergeni e senza parabeni. Dermatologicamente testato.*

- » Assorbe l'umidità
- » Mantiene la pelle fresca e asciutta
- » Lenisce la pelle irritata
- » Ammorbidisce

200 gr

REF. 06429



**Box 100 Wegwerf-Rasiermesser Pollié**  
**Confezione da 100 lamette usa e getta Pollié**



REF. 02480



**Beutel 5 Rasierhobel DERBY BODY**  
**Busta 5 lamette DERBY BODY**



REF.03828

- » Beutel mit 5 Rasierhobeln, mit Schutzkamm
- » Speziell konzipiert zum Entfernen von Körperhaaren, denn der especial Schutzkamm sorgt für eine einfachere und sicherere Rasur bei längeren Haaren
- » Ideal zur Verwendung für die Rasur vor der Laser-Haarentfernung
- » Wird in Krankenhäusern für Rasuren vor einem chirurgischen Eingriff empfohlen
- » Kopfteil und Griff aus Styropor

- » *Confezione da 5 lamette, con pettine protettivo*
- » *Appositamente progettate per rimuovere i peli del corpo grazie allo speciale pettine protettivo che offre una rasatura più facile e sicura dei peli più lunghi*
- » *Ideali da utilizzare per la rasatura prima della depilazione laser*
- » *Consigliato negli ospedali per la rasatura prima dell'intervento chirurgico*
- » *Testa e manico in polistirene*



**Beutel 5 Rasierhobel DERBY 2**  
**Busta 5 lamette DERBY 2**



REF.02948

- » Zwei Klingen
- » Due lame





## Enthaarungspinzetten Pinzette depilatorie

12  
u.m.vta

12  
box



» Kopfspitze  
» Punta convessa

Nickel

REF.01080



» Kopfspitze  
» Punta convessa

Nickel

REF.00938



8 cm



8 cm



» Kopfspitze  
» Punta convessa

Nickel

REF.00939



» Flache Spitze  
» Punta piatta

Inox

REF.02469



9 cm



9,5 cm



» Kopfspitze  
» Punta convessa

Nickel

REF.01081



» Schräge Spitze  
» Punta obliqua

Inox

REF.02468



9 cm



9,5 cm



» Kopfspitze  
» Punta convessa

Nickel

REF.00940



» Feine Spitze  
» Punta fine

Inox

REF.02467



9 cm



9,5 cm



## Enthaarungspinzetten Pinzette depilatorie

12  
u.m.Vta

12  
box



» Kopfspitze  
» Punta convessa

Nickel

REF.00937



» Kopfspitze  
» Punta convessa

Nickel

REF.01974

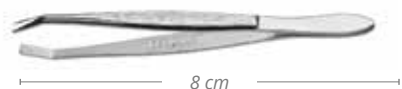

8 cm



8 cm



» Schräge Spitze  
» Punta obliqua

Inox

REF.01404



» Flache Spitze  
» Punta piatta

Inox

REF.01405

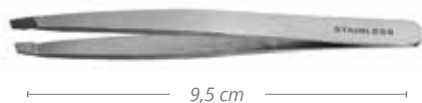

9,5 cm

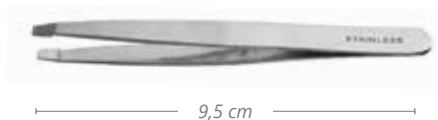

9,5 cm



» Feine Spitze  
» Punta fine

REF.01403



» Feine Spitze  
» Punta fine

REF.01402





9,5 cm



9,5 cm

**Enthaarungspinzetten POLLIÉ**  
**Pinzette depilatorie POLLIÉ**



 12  
 u.m.vta
 
 12  
 box

 » Flache Spitze  
 » Punta piatta

REF.01339

 » Kopfspitze  
 » Punta convessa

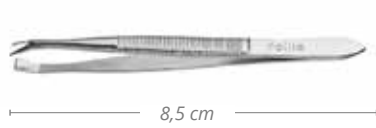
REF.02625



 » Flache Spitze  
 » Punta piatta

REF.01340

 » Kopfspitze  
 » Punta convessa

REF.02626



 » Flache Spitze  
 » Punta piatta

REF.01341



 » Kopfspitze  
 » Punta convessa

REF.02627



 » Flache Spitze  
 » Punta piatta

REF.02793

 » Flache Spitze  
 » Punta piatta

REF.02794

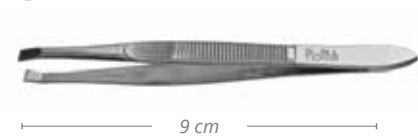

 » Flache Spitze  
 » Punta piatta

REF.02795

 » Schräge Spitze  
 » Punta obliqua

REF.02628

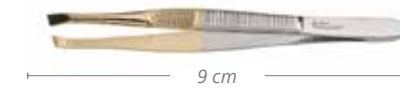

 » Flache Spitze  
 » Punta piatta

REF.02796



### Enthaarungspinzetten POLLIÉ

#### Pinzette depilatorie POLLIÉ

12  
u.m.vta

12  
box



» Kopfspitze  
» Punta convessa

REF.03206

REF.03205



8 cm



8 cm

### Enthaarungspinzetten ANATOMICAL

#### Pinzette depilatorie ANATOMICAL

12  
u.m.vta

12  
box



» Feine Spitze  
» Punta fine



10 cm

Inox

REF.02631



» Flache Spitze  
» Punta piatta



9,5 cm

Inox

REF.02629



» Schräge Spitze  
» Punta obliqua

REF.02540/50



9 cm



» Schräge Spitze  
» Punta obliqua

Inox

REF.02630



9,5 cm



» Schräge Spitze  
» Punta obliqua

REF.02742/50



9,5 cm



» Schräge Spitze  
» Punta obliqua

Inox

REF.02500



10 cm



## Enthaarungspinzetten schräg, farGrande

### Pinzette obliqua, colorate

12  
u.m.vta

12  
box



» Schräge Spitze  
» Punta obliqua



REF.02123



» Schräge Spitze  
» Punta obliqua

Inox

REF.02499



» Schräge Spitze  
» Punta obliqua



REF.02744



6,5 cm

REF.02744/50



» Schräge Spitze  
» Punta obliqua

REF.02743



» Schräge Spitze  
» Punta obliqua

REF.02742



REF.02743/50

REF.02742/50



8 cm



9,5 cm

**Verkaufsträger 24 Pinzetten schräg, farGrande 9,5 cm**  
**Espositore 24 pinzette oblique colorate 9,5 cm**

1  
u.m.vta

20  
box

REF.03723



» Schräge Spitze  
 » Punta obliqua



**Verkaufsträger 24 Pinzetten mit Tieraufdruck 9,5 cm**  
**Espositore 24 pinzette animalier 9,5**

1  
u.m.vta

20  
box

REF.03724



» Schräge Spitze  
 » Punta obliqua



**Verkaufsträger 24 Pinzetten schwarz 9 cm**  
**Espositore 24 pinzette nere 9 cm**

1  
u.m.vta

20  
box

REF.03725



» Schräge Spitze  
 » Punta obliqua



# Maniküre und pediküre

MANICURE  
E PEDICURE

*Nagellacke, Nagellackentferner,  
Manikürelampen, Nagelfräser, Lupen,  
Nagelfeilen, Zangen...*

*Smalti per unghie, solventi per unghie, lam-  
pade per manicure, torni per unghie, lenti  
d'ingrandimento, lime, pinzette...*



### Wie lackiere ich meine Fingernägel? · Come applicare lo smalto

1. Eine Grundlage zum Schutz des Fingernagels auftragen
2. Vor Auftragen des farbigen Lacks ist es notwendig, den Inhalt ein wenig zu bewegen, allerdings in keinem Fall durch Schütteln von oben nach unten, da dies dazu führen kann, dass die Farbe Blasen auf Ihren Fingernägeln hinterlässt. Ideal ist es, den Flakon zwischen die Hände zu legen und horizontal drehen zu lassen. Wenn Sie den Lack auf die Fingernägel auftragen, ist es wichtig, dass Sie dies von der Mitte aus machen und ihn vertikal ausbreiten
3. Die Anwendung erfolgt mit wenig Lack auf dem Pinsel, beginnend von der Nagelhaut bis hin zur Spitze des Fingernagels, von unten nach oben
4. Damit der Lack so lange wie möglich hält, sollte das gewünschte Top Coat aufgetragen werden, das die Spitze versiegelt
5. Zum Schluss, Öl für die Nagelhaut und Handcreme auftragen

1. Applicare una base per proteggere l'unghia
2. Prima di applicare lo smalto colorato, è necessario agitare un po' il contenuto, anche se in nessun caso dovresti farlo scuotendolo dall'alto verso il basso, poiché questo farà sì che lo smalto lasci delle bolle sulle unghie. Il procedimento ideale è quello di prendere il flaconcino con la mano e farlo girare orizzontalmente. Quando applichi lo smalto sulle unghie, è importante farlo dalla metà e stenderlo in maniera verticale
3. L'applicazione verrà eseguita con una piccola quantità di smalto sul pennello, partendo dalla cuticola fino alla punta dell'unghia. Dal basso verso l'alto
4. Affinché lo smalto duri il più a lungo possibile, applicare il Top Coat desiderato, sigillando la punta
5. Per concludere, applicare l'olio per le cuticole e la crema per le mani

### Verkaufsträger Nagellack POLLIÉ Espositore per smalti POLLIÉ

- » 3 Lacke x 33 Farben = 99 Lacke insgesamt
- » 1 farbige Karte
- » Verkaufsträger
- » 1 Poster

- » 3 smalti x 33 colori = 99 smalti in totale
- » 1 tavolozza colori
- » Espositore
- » 1 poster



REF.03609

### Nagellacke POLLIÉ Smalti per le unghie POLLIÉ



12 ml

REF.03505



Solides Weiß  
Bianco "solido"

REF.03507



Weiß  
Bianco



REF.03503



Perlweiß  
Bianco perla

REF.03501



Eis  
Ghiaccio

## Nagellacke POLLiÉ

### Smalti per le unghie Pollié

3  
u.m.vta

3  
box

12 ml

REF.03497

REF.03513

REF.07426

REF.07424

REF.03422



Beige  
Beige



Sandfarben  
Sabbia



**NEW**  
Nackt-Rosa  
Rosa nudo



**NEW**  
Super nackt  
Super nudo



Camel  
Camel

REF.03495



Pastell-Rosa  
Rosa pastello



REF.03494

Perlmutter-Rosa  
Rosa perlato



REF.04477

Candy-Rosa  
Rosa Candy



REF.03496

Kaugummi-Rosa  
Rosa Bubblegum

REF.03504



Fuchsia-Rosa  
Rosa fucsia



REF.04479

Amarant  
Amaranto



REF.03423

Terrakotta  
Terracotta



REF.06239

Remoulade  
Barbabietola

REF.03510



Orange  
Corallo



REF.03511

Fräse  
Fragola



REF.03502

Passionsrot  
Rosso passione



REF.07423

**NEW**

Kirschrot  
Ciliegia

## Nagellacke POLLIÉ

### Smalti per le unghie POLLIÉ



12 ml



REF.03490

Kirschrot  
Rosso ciliegia



REF.04295

Metallic-Rot  
Rosso metallizzato



REF.03493

Granatro  
Granata



REF.03491

Schokolade  
Cioccolato



REF.03859

Gelb  
Giallo



REF.04085

Golden  
Dorato



REF.03499

Bronze  
Bronzo



REF.04292

Kupfer Metallic  
Rame metallizzato



REF.04227

Pastell-Türkis  
Turchese pastello



REF.03860

Smaragdgrün  
Verde smeraldo



REF.04569

Meeresgrün  
Verde mare



REF.04478

Aquamaringrün  
Verde  
acquamarina



REF.04294

Jadegrün  
Verde Giada



REF.03509

Türkis  
Turchese



REF.04570

Wacholdergrün  
Verde ginepro



REF.03420

Waldgrün  
Verde bosco

Nagellacke POLLIÉ  
Smalti per le unghie POLLIÉ3  
u.m.vta3  
box

12 ml



REF.06240

Urwaldgrün  
Verde giungla

REF.03861

Cyanblau  
Blu ciano

REF.04293

Metallic-Blau  
Blu metallizzato

REF.03508

Metallic-Blau  
Blu metallizzato

REF.04567

Indigoblau  
Indigo

REF.03506

Perliges Lila  
Viola perla

REF.04226

Pastell-Lila  
Viola pastello

REF.04568

Amethyst  
Ametista

REF.07425

NEW  
Intensives Lila  
Viola intenso

REF.03421

Violett  
Violetto

REF.04082

Aubergine  
Viola  
melanzana

REF.04291

Silber  
Argento

REF.03512

Mattgrau  
Grigio opaco

REF.03492

Schwarz  
Nero

REF.04084

Silber glitzernd  
Glitter argento

REF.04086

Farbig glitzernd  
Glitter colorato

## Nagellacke POLLIÉ

### Smalti per le unghie POLLIÉ

3  
u.m.vta

3  
box

12 ml



REF.03913

Top Coat "matt" trocknend  
Top coat "opaco" essiccante



REF.04261

Top Coat "matt"  
trocknend  
Top Coat effetto "gel"



REF.03518

Glanz trocknend  
(Top Coat)  
Lucentezza essiccante  
(top coat)



REF.03514

Vitaminreiche  
Grundlage  
Base vitaminica



REF.03515

Anti-Striemen  
Anti righe



REF.03516

Härter  
Indurente



REF.03517

Nagelhautentferner  
Gel  
Gel per rimuovere le  
cuticole

### Karte Farbpalette Nagellack POLLIÉ

#### POLLIE nail polish colours chart

1  
u.m.vta

150  
box

12 ml

REF.06580

» Umfasst 4 Farbräder  
» Include 4 rotelle con i colori



### Spray zum Trocknen der Fingernägel

#### Spray per asciugare le unghie

1  
u.m.vta

12  
box

200 ml

REF.06693

Beschleunigt das Trocknen des Nagellacks, bringt seinen Glanz zur Geltung und verhindert dessen Abnutzung. Auf die gerade lackierten Fingernägel aufsprühen, bei getrennten Fingern und in einem Abstand von etwa 15 Zentimetern.

Accelera l'asciugatura dello smalto, ne esalta la lucentezza e previene il deterioramento della vernice. Nebulizzare sulle unghie dipinte di fresco, separando le dita e ad una distanza di circa 15 centimetri.





**Kit Nagellacke "Back to basics"**  
**Kit smalto "Back to basics"**1  
u.m.vta 6  
box

4 x 12 ml

REF.07154

**Kit Nagellacke französische Maniküre**  
**Kit smalto per manicure francese**1  
u.m.vta 6  
box

4 x 12 ml

REF.03863





### SCHRITT FÜR SCHRITT NAGELLACK P-LACK · PASSO PER PASSO SMALTO P-LACK

1. Eine feine Grundschicht P-Lack Base auftragen, ohne die Nagelhaut oder die Kontur des Fingernagels zu berühren. Den Rand des Fingernagels gut mit der gleichen Grundlage versiegeln. Diesen Vorgang an der ersten Hand durchführen und mit einer UV-Lampe 120 Sekunden oder mit einer LED-Lampe 90 Sekunden lang trocknen/polymerisieren. Mit der anderen Hand wiederholen.
2. Anschließend eine feine Schicht P-Lack Colour auftragen, ohne die Nagelhaut oder die Kontur des Fingernagels zu berühren. Den Rand des Fingernagels gut mit der gleichen Farbe versiegeln. Den Nagellack an der ersten Hand mit einer UV-Lampe 120 Sekunden lang oder mit einer LED-Lampe 90 Sekunden trocknen und polymerisieren. Den gleichen Vorgang an der anderen Hand wiederholen.
3. Eine zweite feine Schicht P-Lack Colour auftragen, unter Befolgung der gleichen Anweisungen wie bei der ersten Schicht. Es ist sehr wichtig, den Rand des Fingernagels gut zu versiegeln.
4. Für eine längere Haltbarkeit und ein perfektes, strahlendes Finish tragen wir eine feine Schicht P-Lack Gloss unter den gleichen Anweisungen wie in den vorangehenden Fällen auf.
5. Zum Schluss die klebrigen Reste entsorgen und die Fingernägel durch Befeuchten eines Pflagetuch aus Zellulose mit dem Nail Cleaner entfetten, Fingernagel für Fingernagel reinigen. Strahlendes Finish ohne dunkle Stellen.
6. Öl auf die Nagelhaut und Feuchtigkeitscreme auftragen

1. Applicare uno strato sottile di P-Lack base, senza toccare le cuticole o il contorno dell'unghia. Sigillare bene il bordo dell'unghia con la stessa base. Eseguire questa operazione nella prima mano e asciugare/polimerizzare con una lampada UV per 120 secondi o con una lampada LED per 90 secondi. Ripetere con l'altra mano.
2. Applicare in seguito uno strato sottile di P-Lack base, senza toccare le cuticole o il contorno dell'unghia. Sigillare bene il bordo dell'unghia con lo stesso colore. Eseguire questa operazione nella prima mano e asciugare e polimerizzare con una lampada UV per 120 secondi o con una lampada LED per 90 secondi. Ripetere la stessa operazione con l'altra mano.
3. Applicare un secondo strato sottile di P-Lack colour seguendo le stesse indicazioni del primo strato. È molto importante sigillare bene il bordo dell'unghia.
4. Per una durata maggiore con una finitura perfetta e brillante, applicare un sottile strato di P-Lack Gloss seguendo le stesse indicazioni dei casi precedenti.
5. Per finire: rimuovere i residui appiccicosi e sgrassare le unghie inumidendo una salvietta in cellulosa con Nail Cleaner, pulire unghia per unghia. Finitura finale lucida senza zone opache.
6. Applicare olio sulle cuticole e crema idratante

#### Farbkarte P-lack Tavolozza colori P-lack



REF.06558



Semi-permanente Nagellacke P-LACK  
Smalti semipermanenti P-LLACK

9 gr

REF.06247



Dark Sky

REF.06246



Flames



REF.06245



Dark Rouge

REF.06248



Summer Fire

REF.06249



Violet Arrow

REF.06250



Rosa Candy

REF.06251



Barbies dress

REF.06253



Rosa Ribbon

REF.06254

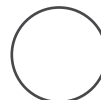

Pure Bianco

REF.06255



Verde Paradise

REF.06256



Clear Rosa

REF.06257



Clear Bianco

REF.06258



Chestnut

REF.06262



Baby Doll

Semi-permanente Nagellacke P-LACK  
Smalti semipermanenti P-LACK

9 gr

REF.06259



Glitter shine top

REF.06260



Top Coat

REF.07117



Top coat no wipe

REF.06261



Base

REF.06244



Nero

REF.06592



Violet

REF.06593



Wine

REF.06594

French  
Rosa

REF.06595



Ferrari

REF.06942

Neongrün  
Verde neon

REF.06943

Neonorange  
Arancio neon

REF.06944

Neongelb  
Giallo neon

REF.06945

Neonrosa  
Rosa neon

### Nail Primer POLLIÉ

#### Primer per unghie POLLIÉ

Nagellack zur Gewährleistung der perfekten Haftung des Gels und des Acryls. Enthält Säuren.

#### ANWENDUNG:

- » 1. Die Fingernägel vorbereiten
- » 2. Eine feine Schicht auftragen und an der Luft trocknen lassen
- » 3. Aufbau-Gel oder Acryl auftragen und das Verfahren fortsetzen

*Smalto per unghie per garantire la perfetta adesione di gel e acrilico. Contiene acidi.*

#### COME USARE:

- » 1. Prepara le unghie
- » 2. Applicare uno strato sottile e lasciare asciugare all'aria
- » 3. Applicare l'acrilico o il gel ricostruttivo e continuare con il processo



7 ml

REF.06673

ACRYLIC GEL  
ACRYLIC GEL



7 ml

REF.07116



Acid free

### P-LACK Nagelvorbereitung

#### P-LACK Nagelvorbereitung



15 ml

REF.07421



NEW

### Nagellack Grundlage/Top Coat

#### Smalto per unghie base/top

Produkt 2 in 1, transparent: Grundlage und Top Coat für das Acryl-Gel. Wird als Grundlage vor dem Acryl-Gel als Top für den Abschluss aufgetragen.

*Prodotto trasparente 2 in 1: base e top per gel acrilico. Si applica come base prima del gel acrilico e poi come top per finire.*



9 gr

REF.06674



## Acrylic gel

### Acrylic gel

1  
u.m.vta

12  
box



Acryl-Gel ist die perfekte Kombination zwischen der Acryl- und der Gel-Technik

#### ANWENDUNG:

- » Das Beste am Acryl: Kraft, Haltbarkeit und maximale Härte mit einer feineren Bearbeitung
- » Das Beste an dem Gel: es ist flexibel, geruchslos, frei von Monomeren, sauber und leicht aufzufüllen. Verfügbar in 5 Farben

*Acrylic Gel è la perfetta combinazione di tecniche acriliche e gel.*

#### COME SI USA:

- » *Il meglio del gel: resistenza, durata e massima durezza con una scolpitura più fine*
- » *La cosa migliore del gel: flessibilità, inodore, senza monomero, pulito e facile da riempire. Disponibile in 5 colori*

- » Transparentes Rosa
- » *Rosa trasparente*

60 gr

REF.06597



- » Weiß
- » *Bianco*

60 gr

REF.06598



- » Hell
- » *Chiaro*

60 gr

REF.06599



- » Tarnfarbe
- » *Mimetico*

60 gr

REF.06600



- » Intensives Rosa
- » *Rosa intenso*

60 gr

REF.06601



**P-LACK Nagelvorbereitung**  
**Preparazione delle unghie P-LACK**

NEW



1 L

REF.07422



**Nagellackentferner P-LACK**  
**Solvente per unghie P-LACK**

- » Reines Azeton
- » Orangen-Parfüm
- » Acetone puro
- » Profumo d'arancia



1 L

REF.06263



**Nagelreiniger P-LACK**  
**Detergente per unghie P-LACK**



1 L

REF.06283



**Nagellackentferner ölig, rosa**  
**Solvente per unghie oleoso rosa**

Nagellackentferner mit Azeton, angereichert mit Rizinusöl. Entfernt den Lack auf sanfte Weise von den Fingernägeln, gibt ihnen Glanz und parfümiert sie

*Solvente acetone arricchito con olio di ricino. Rimuove delicatamente lo smalto dalle unghie, lasciandole lucide e profumate*

- » Mit Azeton
- » Con acetone

**Nagellackentferner ohne Azeton**  
**Solvente per unghie senza acetone**

Mit Rizinusöl, das die Nagelhaut hydratisiert  
*Con olio di ricino per idratare le cuticole*

- » Acetonfrei, mit Dosierer
- » Senza acetone, con dosatore



150 ml

REF.06608



1 L

REF.06607



500 ml

REF.07172

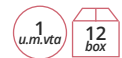

1 L

REF.07173



### Nagellackentferner P-LACK

Solvente per unghie P-LACK

NEW

1  
u.m.vta19  
box

150 ml

REF.07109



NEW

1  
u.m.vta12  
box

1 L

REF.07110



### Nagelreiniger (Reiniger / Entfetter)

Detergente per unghie (detergente / sgrassante)

NEW

1  
u.m.vta19  
box

150 ml

REF.07111



NEW

1  
u.m.vta24  
box

400 ml

REF.07112





### Nagellackentferner express Solvente per unghie Express

1 u.m.vta  
150 box

40 ml

REF.04262

- » Mit Schwamm und Azeton
- » Con spugna e acetone



### Dose 10 einzelne Fingeranfeuchter Confezione da 10 ditali per ammollo

1 u.m.vta  
12 box

- » Nicht mit Nagellackentferner ohne Azeton verwenden
- » Non utilizzare con solvente per smalto senza acetone

REF.03879



### Folien zur Nagellackentfernung 100 Stück Fogli laminati avvolgenti per rimozione 100 unità

1 u.m.vta  
107 box

Silberpapierfolien aus Aluminium mit Watte, für eine einfache und bequeme Anwendung mit dem Nagellackentferner oder mit Azeton auf den Fingernägeln.

Fogli di alluminio laminato con cotone incorporato per essere facili e comodi da applicare con il solvente o l'acetone sull'unghia.



100 u

REF.04824

### Handcreme ultra-feuchtigkeitsspendend nahrhaft Crema per le mani nutriente ultra idratante

Eine Ultra-Feuchtigkeitscreme, nahrhaft, ohne fettiges Gefühl an den Händen in einem sanften, aber kräftigen Schutzschleier.

**Weinrosenöl** erweist sich als sehr wirkungsvoller Regenerator für unsere Haut

- » Es wirkt oberflächlich zur natürlichen Befeuchtung und zur Verbesserung die Hydratation
- » Sorgt für Nährstoffe und regeneriert
- » Reduziert den Wasserverlust in unserer Epidermis, da es die Ceramid-Barriere stärkt und erhöht
- » Korrigiert und verhindert Probleme der Haut aufgrund von Lichtalterung, durch die Selbsterzeugung von Melanin
- » Kräftigt den Fibroblast, die Hautzelle, die das Kollagen erzeugt, Hyaluronsäure, Elastin und verantwortlich für die Festigkeit und Elastizität unserer Haut

Una crema ultra idratante e nutriente non grassa che avvolge le mani in una morbida e potente pellicola riparatrice.

L'Olio di rosa mosqueta risulta essere un potentissimo rigeneratore per la nostra pelle

- » Agisce in superficie come fattore idratante naturale, migliorando l'idratazione.
- » Nutre e rigenera
- » Riduce la perdita di acqua della nostra epidermide, poiché rinforza e moltiplica la barriera di ceramidi
- » Corregge e previene i problemi cutanei dovuti al fotoinvecchiamento, attraverso l'autogenerazione della melanina.
- » Rin vigorisce il fibroblasto, che è la cellula dermica che produce collagene, acido ialuronico, elastina ed è responsabile della compattezza e dell'elasticità della nostra pelle

- » Mit Dosierer
- » Con dosatore

1 u.m.vta  
12 box

500 ml

REF.07083

1 u.m.vta  
12 box

100 ml

REF.07082



**Lüfterbürste mit Kunsthaar****Pennelli a ventaglio con pelo sintetico**» Groß  
» Grande

NEW



REF.07097

NEW



REF.07098

**Nagelpinsel für Acrylnägel Kolinsky****Pennelli per unghie acriliche Kolinsky**

» Marderhaar

Gilt als bestes Haar bei Pinseln für Acrylnägel aufgrund seiner Widerstandskraft und Haltbarkeit, seiner hohen Elastizität und der maximalen Absorption des Produkts.

» Setole di zibellino

Considerato il miglior pelo per pennelli per unghie acriliche per la sua resistenza e durata, per la sua grande elasticità e il massimo assorbimento del prodotto.



N° 2

REF.03659



N° 4

REF.03660



N° 6

REF.03661



N° 8

REF.03662

**Nagelpinsel für Gel****Pennelli per unghie gel**

» Nylonhaare

» Setole in nylon



N° 2

REF.03654



N° 4

REF.03655



N° 6

REF.03656



N° 8

REF.03657



N° 10

REF.03658



Gel wird auf die Fingernägel nicht mit dem normalen Nagelpinsel von Kolinsky aufgetragen, das für Acrylnägel verwendet wird. Denken Sie daran, je höher die Anzahl Ihrer Pinsel ist, desto höher ist deren Dicke.

Wenn Sie die Fingernägel mit Gel behandeln möchten, müssen Sie Spezialpinsel verwenden, die Ihnen das Auftragen des Gels erleichtern. Denn Gel verhält sich anders als Acryl. Aus diesem Grunde werden sehr unterschiedliche Pinsel verwendet.

Heute sind die Pinsel für das Auftragen von Gel aus Nylon (synthetisch). SYNTHETISCHE HAARE, ZWINGE AUS ALUMINIUM, GRIFF AUS HOLZ

Le unghie di gel non vengono fatte con il solito pennello di pelo kolinsky che viene utilizzato per le unghie acriliche. Ricorda, più grande è il numero sul pennello, più grande sarà lo spessore del pennello stesso.

Se vuoi scolpire le unghie in gel, devi usare pennelli speciali che ti facilitano il posizionamento del gel. Questo perché il gel è diverso dall'acrilico. Per questo motivo vengono utilizzati pennelli molto diversi.

Attualmente i pennelli utilizzati per applicare il gel sono in nylon (sintetici). SETOLE SINTETICHE, GHIERA IN ALLUMINIO, MANICO IN LEGNO

### Satz mit 6 Pinseln zur Fingernagel-Dekoration Set da 6 pennelli per decorazione unghie

1 u.m.vta  
12 box

» Synthetisches Haar  
» Setole sintetiche



REF.03653

### Pinsel für Gel + Stößel für Nagelhaut Pennello per gel + spingi cuticole

1 u.m.vta  
12 box

Nail art



REF.06760

### Pinsel „Dotting“ für Fingernägel Pennello dotting per unghie

1 u.m.vta  
12 box

Nail art

REF.06761



### Pinsel „Gradient“ für Fingernägel Pennello gradiente per unghie

1 u.m.vta  
12 box

Nail art

REF.06762

» 4 Austauschspitzen  
» 4 punte di ricambio



### Pinselständer, schwarz Portapennelli nero

1 u.m.vta  
12 box

REF.04822



### Satz Nail Art Set nail art

1 u.m.vta  
42 box

REF.06759

» 15 Pinsel für Fingernägel  
» 5 Pinsel mit doppelter Metallspitze

» 15 pennelli per unghie  
» 5 a doppia punta in metallo



## Original für Maniküre Manicure originali



Mit den Punzen können Sie die Fingernägel dekorieren und eine Vielzahl von Formen, Linien, Punkte, Blumen kreieren, alle in verschiedene Farben. Die Pinsel mit feiner Spitze helfen Ihnen, diese kleinen Details aufzutragen, die aus Ihren Fingernägeln ein kleines Kunstwerk machen.

Con i punzoni puoi decorare le unghie e realizzare innumerevoli forme, linee, punti, fiori, tutti in diversi colori. I pennelli a punta fine ti aiuteranno a realizzare quei piccoli dettagli che renderanno le tue unghie una piccola opera d'arte.

### Satz 5 Punzen zur Dekoration der Fingernägel Set da 5 punzoni per decorare le unghie



REF.04093

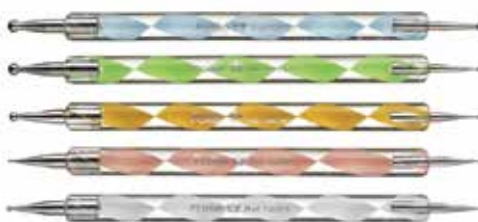

### Strass Rhinestone Nail Art Rad Disco strass per nail art



600 u

REF.06774

### Fimo Nail Art Blumen und Obst Rad Disco Fimo per nail art fiori e frutti



144 u

REF.04835

**Strass Rhinestone Farben Nail Art Rad**  
*Disco strass colori per nail art*



» Mini  
 » Mini

**NEW**



600 u

REF.07347

**NEW**



600 u

REF.07345

**Strass Rhinestone Silber- Nail Art Rad**  
*Disco strass argento per nail art*

**NEW**



144 u

REF.07346

**NEW**



144 u

REF.07342

**Sequins rhinestones nail art wheel**  
*Per nail art con paillettes strass*

**NEW**



144 u

REF.07343

**NEW**



REF.07352

**Friedens- und Liebeskarussell**  
*Giostra della pace e dell'amore*

### 3D-Aufkleber Adesivi 3D



» Weiße Herzen  
» Cuori bianchi

**REF. 04831**

» Weiße Schmetterlinge  
» Farfalle bianche

**REF. 04832**



» Weiße Blumen  
» Fiori bianchi

**REF. 04833**

» Farbige Blumen  
» Fiori colorati

**REF. 04834**



### Folie Nail Art 1,5 mm Lamina per nail art 1,5 mm



» Schwarz  
» Nera

**REF. 06770**

» Golden  
» Dorata

**REF. 06768**

» Silber  
» Argentata

**REF. 06769**



### Kleband für Fingernägel 0,8 mm Nastro adesivo per unghie 0,8 mm



» Schwarz  
» Nera

**REF.06773**

» Golden  
» Dorata

**REF.06771**

» Silber  
» Argentata

**REF.06772**



### Dekoration für Nail Art Decorazione per nail art



» Trockenblumen  
» 12 Farben

**REF.06763**

» Verschiedene Glitter  
» 16 g x 12 Farben

**REF.06764**

» Fiori secchi  
» 12 colori

» Assortimento di glitter  
» 16 g x 12 colori



» Sortiment  
Samtpulver  
» 0,5 g x 12 Farben

**REF.06765**

» Sortiment Samtpulver  
» 1 g x 12 Farben

**REF.06766**

» Blattgold 12  
Farben

**REF.06767**

» Polveri vellutate  
assortite  
» 0,5 g x 12 colori

» Glitter squame di sirena  
» 1 g x 12 colori

» Foglia d'oro in  
12 colori



## Dekoration für Nail Art Decorazione per nail art



» Mikrokristall-Kaviar-Nagelkunstkugeln  
» 1,5 g x 12

» Palline per nail art al caviale micro  
cristallo  
» 1,5g x 12

REF.07344

» Glitter pulver glitter nail art  
» 1,5g x12 farben

» Polvere glitter glitter nail art  
» 1,5 g x 12 colori

REF.07348

NEW



NEW



» Nail Art Sandpulver  
» 1,5 g x 12 Farben

» Polveri di sabbia per  
nail art  
» 1,5 g x 12 colori

REF.07349

» Verschiedene Glitzer Nail Art Glitter  
» 1,5 g x 12 Farben

» Glitter assortiti nail art glitter  
» 1,5 g x 12 colori

REF.07350

NEW



NEW



» Glitzerflocken-Rauten  
» 1,5 x 12 g

» Rombi fiocchi glitterati  
» 1,5 x 12 g

REF.07351

» Perlglanznagelkunstpalette  
» Tavolozza per unghie perlescente

1 u.m.vta 12 box

144 u

REF.07382

NEW



NEW





**Nagelform für Fingernägel**  
**Stampo per unghie**» Rechteckig  
» Rettangolare

500 u

REF.04825

» Hufeisen mittel  
» Ferro di cavallo medi

500 u

REF.04826

» Doppelte Dicke  
» Doppio spessore

500 u

REF.04827

**Transparenter Dispenser für Nagelformen**  
**Dispenser trasparente per stampi per unghie**

REF.04828

**Wiederverwendbare Nagelformen**  
**Stampi per unghie riutilizzabili**

5 u

REF.06750

**Schablonen für French Manicure**  
**Guide per manicure francese**

REF.04829

» Formen  
» Forme

REF.04830



## Fingernageltips Tip per unghie



1  
u.m.vta

46  
box

» Natürlich

» *Naturali*



100 u

REF.06743

» Natürlich  
rund

» *Curve naturali*



100 u

REF.06744

» Weiß eckig

» *Bianche  
quadrate*



100 u

REF.06745

» Weiß eckig

» *Bianche curve*



100 u

REF.06746

» Transparent eckig

» *Trasparenti  
quadrate*



100 u

REF.06747

» Transparent rund

» *Trasparenti curve*



100 u

REF.06748

## Beutel 10 Paletten für Demo Confezione 10 palette per demo



1  
u.m.vta

15  
box

» Natürlich

» *Naturale*

REF.06751

» Transparent

» *Trasparente*

REF.06752



### Künstliche Hand für Manikürepraxen Mano articolata per esercitazioni di manicure



REF.07080

### Ersatzteil Ricambio

» Beutel 100 Fingernägel für künstliche Hände  
» Confezione da 100 unghie per mano articolata



REF.07081



### Weiche Hand für Manikürepraxen Mano morbida per esercitazioni manicure



REF.04356

» Mit Ständer  
» Con supporto



REF.04353



### Vorgeschnittene Zellulose Cellulosa pretagliata

Beutel mit 2 Rollen vorgeschchnittener Zellulose in Stücken von 4 x 5 cm. Jede Rolle besteht aus 500 Stück absorbierender Pflaster. Ideal zur Entfernung von Nagellack, ohne Flusen zu hinterlassen. Ø 15 · Gewicht: 155 g, Toleranz 15 g

Busta con 2 rotoli di cellulosa pretagliati in pezzi di 4 x 5 cm. Ogni rotolo è di 500 unità assorbenti. Ideale per rimuovere lo smalto dalle unghie senza lasciare tracce di pelucchi. Ø 15 Peso: 155 g Tolleranza 15 g



REF. 03060

» Anonym  
» Anonimo



03060/00



(2 x 500ud)



(2 x 500ud)

### Dispenser + 1000 Pad Nail

#### Dispenser + 1000 pad nail

1 u.m.vta  
12 box

Vorgeschchnittene kleine Quadrate, bequem zu benutzen, ohne Flusen zu hinterlassen. Ideal zur Entfernung von Nagellack mit Azeton oder der klebrigen Schicht von semi-permanentem Lack.

*Quadretti pretagliati comodi da usare poiché lasciano pelucchi. Ideale per rimuovere lo smalto con acetone o lo strato appiccicoso del semipermanente.*



REF.06471

### Abdeckband

#### Nastro protettivo

1 u.m.vta  
12 box

- » Rosa
- » Rosa

REF.06757



### Godet Tube 5 Stück

#### Bicchierini in plastica 5 u.

1 u.m.vta  
12 box

- » Kunststoff
- » Plastica

REF.06758



### Gläschen für Maniküre

#### Bicchiere per manicure

1 u.m.vta  
12 box

- » Glas
- » Cristallo

REF.06756



### Keramikbehälter Korkdeckel

#### Contenitore in ceramica con tappo in sughero

1 u.m.vta  
106 box

- » Weiß
- » Bianco

REF.06775



### Clips Soak-off-Entferner 10 Stück

#### Clip remover da ammollo 10 u

1 u.m.vta  
106 box

- » Weiß
- » Bianco

REF.06777

- » Rosa
- » Rosa

REF.06778



**Lampe für Fingernägel UV-LED 65w, Modell: Silver LIGHT**  
**Lampada per unghie UV-LED da 65w modello: Silver LIGHT**



REF. 07186



NEW

- » Leistung 65 W
- » Gewicht: 450 g
- » UV-LED-Lampen: 33 Stück
- » Wellenlänge LEDs: 395- 405 nm
- » Spannung: 100 – 240 V
- » Frequenz 50/60 Hz
- » Timer: 10, 30, 60 und 99 Sekunden
- » Ausgang Adapter: DC 24 V = 2A
- » Betriebstemperatur: -10°C – 35°C
- » Abnehmbare magnetische Metallunterlage.

- » Potenza: 65 W.
- » Peso: 450 g
- » LED UV: 33 unità
- » Lunghezza d'onda LED: 395- 405nm
- » Voltaggio: 100 – 240V
- » Frequenza 50/60 Hz
- » Timer: 10", 30", 60" e 99" secondi
- » Uscita trasformatore: DC 24V = 2A
- » Temperatura operativa: -10°C -35°C
- » Base magnetica estraibile in metallo.



Wir präsentieren Ihnen unsere UV-LED-Lampen mit 48 W (Ref.-Nr. 06638, Modell MOON LIGHT und 06639 Modell SUN LIGHT). Sie sind die ideale Ergänzung für das rasche und sichere Trocknen von semi-permanentem Nagellack und Aufbau-Gels in der Maniküre/Pediküre, insbesondere für Lacke, für die das Trocknen mit LED-Lampen vorgesehen ist.

Vi presentiamo le nostre lampade UV LED da 48W (Rif.06638 modello MOON LIGHT e 06639 modello SUN LIGHT), sono il complemento ideale per una asciugatura rapida e sicura di smalti semipermanenti e gel di ricostruzione in manicure/pedicure, nonché appositamente pensate per l'asciugatura a LED

### Lampe für Fingernägel UV-LED 48w, Modell: MOON LIGHT Lampada per unghie UV-LED da 48w modello: MOON LIGHT



REF. 06638



- » Leistung: 48 W
- » Gewicht: 450 g
- » UV-LED-Lampen: 21 Stück
- » Wellenlänge LEDs: 395- 405 nm
- » Spannung: 100 – 240 V
- » Frequenz 50/60 Hz
- » Timer: 30, 60 und 99 Sekunden
- » Ausgang Adapter: DC 24 V 1,5 A
- » Betriebstemperatur: -10°C – 35°C

- » Potenza: 48 W.
- » Peso: 450 g
- » LED UV: 21 unità
- » Lunghezza d'onda LED: 395- 405nm
- » Voltaggio: 100 – 240V
- » Frequenza 50/60 Hz
- » Timer: 30", 60" e 99" secondi
- » Uscita trasformatore: DC 24V 1,5A
- » Temperatura operativa: -10° -35°C



### Lampe für Fingernägel UV-LED 48W, Modell: SUN LIGHT Lampada per unghie UV-LED da 48W modello: SUN LIGHT



REF. 06639



- » Leistung: 48 W
- » Gewicht: 560 g
- » UV-LED-Lampen: 24 Stück
- » Wellenlänge LEDs: 395-405 nm
- » Spannung: 100 – 240 V~
- » Frequenz 50/60 Hz
- » Timer: 10, 30, 60 und 99 Sekunden
- » Ausgang Adapter: DC 24V 1.5A
- » Betriebstemperatur: -10°C – 35°C
- » Abnehmbarer Standfuß

- » Potenza: 48 W.
- » Peso: 560gr
- » LED UV: 24 unità
- » Lunghezza d'onda Led: 395-405 nm
- » Voltaggio: 100 – 240V~
- » Frequenza 50/60 Hz
- » Timer: 10" 30", 60" e 99" secondi
- » Uscita trasformatore: DC 24V 1.5A
- » Temperatura operativa: -10°C -35°C
- » Base staccabile



Wir präsentieren Ihnen unsere UV-LED-Lampen mit 48 W (Ref.-Nr.-Nr. 06640, Modell POWER LIGHT und 06641 Modell FAST LIGHT). Sie sind die ideale Ergänzung für das rasche und sichere Trocknen von semi-permanentem Nagellack und Aufbau-Gels in der Maniküre/Pediküre, insbesondere für Lacke, für die das Trocknen mit LED-Lampen vorgesehen ist.

Vi presentiamo le nostre lampade UV LED da 48W (Rif.06640 modello POWER LIGHT e 06641 modello FAST LIGHT), sono il complemento ideale per una asciugatura rapida e sicura di smalti semipermanenti e gel di ricostruzione in manicure/pedicure, nonché appositamente pensate per l'asciugatura a LED.

### Lampe für Fingernägel UV-LED 48W, Modell: POWER LIGHT Lampada per unghie UV-LED da 48W modello: POWER LIGHT



REF. 06640



- » Leistung: 48 W
- » Gewicht: 880 g
- » LED/UV-Perlen: 36 Stück
- » Wellenlänge LEDs: 395-405 nm
- » Spannung: 100 – 240 V~
- » Frequenz 50/60 Hz
- » Timer: 30, 60 und 99 Sekunden
- » Ausgang Adapter: DC 24V 1,5A
- » Betriebstemperatur: -10°C – 35°C
- » Abnehmbarer Standfuß
- » Für Maniküre und Pediküre

- » Potenza: 48 W.
- » Peso: 880 g
- » Led UV: 36 unità
- » Lunghezza d'onda Led: 395-405 nm
- » Voltaggio: 100 – 240V~
- » Frequenza 50/60 Hz
- » Timer: 30", 60" e 99" secondi
- » Uscita trasformatore: DC 24V 1,5A
- » Temperatura operativa: -10°C – 35°C
- » Base staccabile
- » Per manicure e pedicure



### Lampe für Fingernägel UV-LED 48W, Modell: FAST LIGHT Lampada per unghie UV-LED da 48W modello: FAST LIGHT



REF. 06641



- » Leistung: 48 W
- » Gewicht: 740 g
- » LED/UV-Perlen: 36 Stück
- » Wellenlänge LEDs: 395-405 nm
- » Spannung: 100 – 240 V~
- » Frequenz 50/60 Hz
- » Timer: 10, 30, 60 und 99 Sekunden
- » Ausgang Adapter: DC 24V 1,5A
- » Betriebstemperatur: -10°C – 35°C
- » Abnehmbarer Standfuß

- » Potenza: 48 W.
- » Peso: 740 g
- » Led UV: 36 unità
- » Lunghezza d'onda LED: 395-405 nm
- » Voltaggio: 100 – 240V~
- » Frequenza 50/60 Hz
- » Timer: 10" 30", 60" e 99" secondi
- » Uscita trasformatore: DC 24V 1,5A
- » Temperatura operativa: -10°C – 35°C
- » Base staccabile



Wir präsentieren Ihnen unsere LED-Lampen mit 24 W (Ref.-Nr.-Nr. 04919 Modell STAR LIGHT( und 48 W (Ref.-Nr.-Nr. 04920 Modell ENERGY LIGHT), sie sind die ideale Ergänzung für das rasche und sichere Trocknen von semi-permanentem Nagellack und Aufbau-Gels in der Maniküre/Pediküre, insbesondere für Lacke, für die das Trocknen mit LED-Lampen vorgesehen ist.

*Vi presentiamo le nostre lampade LED da 24W (rif. 04919 modello STAR LIGHT) e da 48W (rif. 04920 modello ENERGY LIGHT). Sono il complemento ideale per asciugare smalti semipermanenti e gel di ricostruzione in manicure e pedicure, oltre a quelli appositamente formulati per l'asciugatura a LED.*

### LED-UV-Lampe 24W STAR LIGHT Lampada led UV STAR LIGHT 24W



REF. 04919



- » Leistung: 24W
- » LED/UV-Perlen: 15 Stück
- » Wellenlänge LEDs: 395-405 nm
- » Spannung: 100-240 V~
- » Frequenz 50/60 Hz
- » Timer: 10, 30, 60 und 99 Sekunden
- » Abnehmbarer Standfuß für Maniküre und Pediküre

- » Potenza: 24W.
- » LED/UV: 15 unità
- » Lunghezza d'onda LED: 395-405 nm
- » Voltaggio: 100-240V~
- » Frequenza 50/60 Hz
- » Timer: 10" 30", 60" e 99" secondi
- » Base staccabile per manicure e pedicure



### LED-UV-Lampe 48W ENERGY LIGHT Lampada LED UV ENERGY LIGHT 48W



REF. 04920



- » Leistung: 48 W
- » LED/UV-Perlen: 24 Stück
- » Wellenlänge LEDs: 395-405 nm
- » Spannung: 100-240 V~
- » Frequenz 50/60 Hz
- » Timer: 10, 30, 60 und 90 Sekunden
- » Abnehmbarer Standfuß für Maniküre und Pediküre

- » Potenza: 48 W.
- » LED/UV: 24 unità
- » Lunghezza d'onda LED: 395-405 nm
- » Voltaggio: 100-240V~
- » Frequenza 50/60 Hz
- » Timer: 10" 30", 60" e 90" second
- » Base staccabile per manicure e pedicure





### UV-Lampe 36W mit Timer

#### Lampada UV da 36W con timer



REF. 03150

Professionelle UV-Lampe Pollié, ideal für die Maniküre oder Pediküre von Finger- bzw. Zehennägeln mit Gel, permanentem Lack in Gel, semi-permanentem Lack oder jede andere Technik, die das Trocknen der Hände und Füße mit einer Lampe erfordert.

- » Leistung: 36W
- » Timer: 90 Sekunden, 120 Sekunden und 30 Minuten
- » 4 UV-Lampen (4x9W) 36 W
- » Ausziehbare Ablage

Lampada UV Pollié professionale, ideale per manicure o pedicure di unghie in gel, smalto gel permanente, smalto semipermanente o qualsiasi altra tecnica che richieda l'asciugatura con lampada su mani e piedi.

- » Potenza: 36W.
- » Timer: 90 "secondi, 120" secondi e 30 minuti
- » 4 lampadine UV (4x9W) 36W
- » Vassoio rimovibile



### Ersatzlampen · Ricambi lampadine

REF. RE03150/01

- » 9W UV
- » 9W UV



REF. RE04354/02

- » 9W UV led
- » 9W UV led



### Mini-LED-Lampe 2W tragbar USB

#### Mini lampada LED USB portatile da 2W



REF. 04355

- » Leistung: 2W
- » Speziell für Fingernägel mit Gel, semi-permanenten Lack
- » UV-Licht 365 nm
- » Timer 10"
- » USB-KABEL INBEGRIFFEN
- » Ideal für die Reise und den Transport wegen seines kleinen Taschenformats

- » Potenza: 2W.
- » Speciale per unghie in gel, smalto semipermanente
- » Luce UV 365 nm
- » Timer 10"
- » CAVO USB INCLUSO
- » Ideale per viaggiare e da trasportare grazie alle sue piccole dimensioni tascabili



## Spa für Maniküre

### Spa manicure



REF. 04265

- » Leistung: 2W
- » Batterie nicht inbegriffen
- » Stimulierende Sprudelmassage vor der Maniküre, die die Nagelhaut entspannt
- » Spannung: 100-240 V~
- » Frequenz 50/60 Hz

- » Potenza: 2W.
- » Batteria non inclusa
- » Massaggio stimolante pre-manicure con bollicine che ammorbidiscono le cuticole
- » Voltaggio: 100-240V~
- » Frequenza 50/60 Hz



## Staubsauger für Maniküre

### Aspirapolvere per manicure



Tischsauger für den Staub der Maniküre, elegant und sehr funktional. Modernes, neuartiges Design. Saugt den Staub, der beim Nagelfeilen der Fingernägel entsteht, perfekt ab. Der Staub wird schließlich in einem passenden Beutel entsorgt, womit das Einatmen von Staubresten verhindert wird.

- » Leistung: 2W
- » Batterie nicht inbegriffen
- » Mit 3 Austauschbeuteln

Aspiratore da tavolo per la polvere della manicure, elegante e molto funzionale, dal design moderno e innovativo. Raccoglie perfettamente la polvere che si forma durante l'affilatura delle unghie. Grazie al tornio, la polvere va sotto l'aspirapolvere, in un apposito sacchetto, evitando così di respirare residui di polvere.

- » Potenza: 2W.
- » Batteria non inclusa
- » Con 3 sacchetti di ricambio



REF. 04205

## Paraffin: hydratisiert, nahrhaft für Ihre Hände und Füße

### Paraffina: idrata e nutre mani e piedi



500 gr

- » Hydratisiert in der Tiefe
- » Verbessert sichtbar das Aussehen der Haut
- » Macht die Haut elastischer
- » Verbessert die Mikrozirkulation des Blutes
- » Begünstigt die Absorption von Wirkstoffen
- » Hilft beim Entfernen von Flüssigkeiten und Giftstoffen
- » Hilft gegen Verspannungen und erleichtert die Massage
- » Beruhigt den Schmerz und die Entzündung

- » Idrata in profondità
- » Migliora notevolmente l'aspetto della pelle
- » Elasticizza la pelle
- » Migliora la microcircolazione sanguigna
- » Favorisce l'assorbimento dei principi attivi
- » Aiuta ad eliminare liquidi e tossine
- » Migliora le contratture e facilita il massaggio
- » Calma il dolore e l'infiammazione

### Paraffin Monoi aus Tahiti und Minze

Restaurierende und kräftigende Behandlung der Haut von Händen und Füßen. Monoi-Öl aus Tahiti bringt den natürlichen Wasser-Lipid-Mantel der Haut ins Gleichgewicht. Es macht sie elastischer und sorgt für eine hohe Fähigkeit zur Feuchtigkeitsretention. Kräftigt und erfrischt die Haut dank des Minzöls.

REF. 04671

#### Paraffina monoi di tahiti e menta

Trattamento ricostituente-tonificante per la pelle delle mani e dei piedi. Il Monoi di Tahiti riequilibra lo strato idrolipidico naturale della pelle. Lo rende più elastico e fornisce una grande capacità di trattenere l'umidità. Grazie all'olio di menta piperita tonifica e rinfresca la pelle.



### Paraffin Orange und Pfirsich

Nährhafte und schützende Behandlung der Haut von Händen und Füßen. Reich an Karotin, besitzt hohe antioxidative Eigenschaften. Die ideale Behandlung für reife und dehydrierte Haut.

REF. 04672

#### Paraffina arancia e pesca

Trattamento nutritivo-protettivo per la pelle delle mani e dei piedi. Ricca di caroteni, ha importanti proprietà antiossidanti. È un trattamento ideale per pelli mature e disidratate.



### Paraffin Shea-Butter

Zur Antioxidationsbehandlung. Shea-Butter ist einer der besten Feuchtigkeitsspender und Aufweichungsmittel par excellence. Sorgt für Wohlbefinden und schützt die Haut.

REF. 04673

#### Paraffina al burro di karité

Trattamento antiossidante. Il Burro di karité è uno degli idratanti ed emollienti per eccellenza. Dona benessere e protezione alla pelle.



## Digitaler Paraffinerwärmer mit Temperaturspeicher

### Riscaldatore digitale per paraffina con memoria della temperatura



REF. 06335

- » Leistung: 200 W
- » Fassungsvermögen: 2 kg
- » Spannung: 220-240 V~
- » Frequenz: 50 Hz
- » Temperatur: 40°C bis 70°C
- » Geeignet für Füße und Hände

- » Potenza: 200 W.
- » Capacità: 2 Kg
- » Voltaggio: 220-240V~
- » Frequenza: 50 Hz
- » Temperatura: 40°C - 70°C
- » Adatto per piedi e mani



**Beutel mit 2 Schutzhandschuhen für die Haut gegen UV-Licht und gegen Flecken**  
**Confezione da 2 guanti di protezione per la pelle anti-UV e anti-macchie**

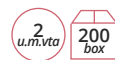

REF. 04686



**Beutel mit 2 Fausthandschuhen Frottee Paraffin**  
**Confezione da 2 guanti di spugna per paraffina**



REF. 06615



Fausthandschuhe aus Frottee für die Behandlung mit Paraffin. Ihr Innenfutter bewahrt die Temperatur für ein optimales Ergebnis der Behandlung.

*Guanti di spugna per il trattamento con paraffina. Il loro rivestimento interno permette di mantenere la temperatura per un risultato di trattamento ottimale.*

**Beutel mit 2 Wollsocken Frottee Paraffin**  
**Confezione da 2 pantofole di spugna per paraffina**



REF. 06616



Wollsocken aus Frottee für die Behandlung mit Paraffin. Ihr Innenfutter bewahrt die Temperatur für ein optimales Ergebnis der Behandlung.

*Pantofole di spugna per il trattamento con paraffina. Il loro rivestimento interno permette di mantenere la temperatura per un risultato di trattamento ottimale.*

**Pack 50 Kunststoffbeutel Paraffin**  
**Confezione da 50 sacchetti in plastica per paraffina**



REF. 06617

Kunststoffbeutel für die Behandlung von Händen oder Füßen mit Paraffin. Verstärkt die Wärme und verhindert ein rasches Verdampfen.

*Sacchetti di plastica per il trattamento con paraffina sia delle mani che dei piedi. Intensificano il calore e ne impediscono che evaporino rapidamente.*



### Professioneller Nagelfräser 30.000 rpm Tornio professionale da 30.000 giri/min



REF. 06624



Leistungsstarker Nagelfräser für die professionelle Arbeit. Geräuscharmer Motor und einfache Handhabung für ein komfortables Arbeiten.

- » Leistung: 45W
- » Spannung: 110 – 120 V
- » Gewicht Manipel: 157 g
- » Motorgrundgewicht: 1250 g

*Tornio dalle ottime prestazioni per professionisti. Motore silenzioso e impugnatura leggera che permette di lavorare comodamente.*

- » Potenza: 45W.
- » Voltaggio: 110 – 120 V
- » Peso della fresa: 157 g
- » Peso base motore: 1250 g



### Professioneller Nagelfräser 30.000 rpm Tornio professionale da 30.000 giri/min



REF. 06625

Nagelfräser mit sensationellem Preis-Leistungs-Verhältnis. Geräuscharm und haltbar, geeignet für Profis und Auszubildende.

Umfasst: 6 Accessoires + 6 Schleifpapiere  
Include: 6 accessori + 6 mole

- » Leistung: 30 W
- » Spannung: 110 – 120 V
- » Gewicht Manipel: 130 g
- » Motorgrundgewicht: 730 g

*Tornio con un favoloso rapporto qualità/prezzo. Silenzioso e durevole progettato per la professionista e l'apprendista.*

- » Potenza: 30 W.
- » Voltaggio: 110 – 120 V
- » Peso della fresa: 130 g
- » Peso base motore: 730 g



### Nagelfräser Maniküre POCKET Tornio per manicure POCKET



REF. 06695

- » Leistungsstark, geräuscharm und tragbar
- » Kompaktes Design, ideal für die Reise
- » Sehr leicht
- » 10 Stunden Betriebsautonomie
- » Geschwindigkeit: 30.000 rpm
- » Leistung: 24 W
- » Stromstärke der Batterie: 2.000 mA (11.1V)
- » Ladezeit der Batterie: 2 Stunden
- » Betriebsdauer der Batterie bei Höchstgeschwindigkeit: 10 Stunden
- » Sehr geräuscharm, erhitzt sich nicht und vibriert nicht
- » Gewicht Flacon: 283 g
- » Gewicht Manipel: 157 g
- » Spannung: 110 - 220 V
- » Class II 50/60 Hz

Umfasst: 6 Accessoires + 6 Schleifpapiere  
Include: 6 accessori + 6 mole

- » *Potente, silenzioso e portatile*
- » *Design compatto perfetto per i viaggi*
- » *Molto leggero*
- » *10 ore di autonomia*
- » *Velocità: 30.000 RPM*
- » *Potenza: 24 W.*
- » *Capacità della batteria: 2.000 mA (11.1V)*
- » *Tempo di ricarica della batteria: 2 ore*
- » *Durata della batteria alla massima velocità: 10 ore*
- » *Molto silenzioso, non si riscalda né vibra*
- » *Peso della base: 283 g*
- » *Peso della fresa: 157 g*
- » *Voltaggio: 110 - 220 V*
- » *Classe II 50/60 Hz*



### Nagelfräser Maniküre QUICK Tornio per manicure QUICK

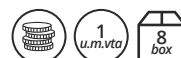

REF. 06696

- » Leistungsstark und geräuscharm
- » Kompaktes Design, ideal für die Reise
- » Sehr leicht
- » Geschwindigkeit: 30.000 rpm
- » Leistung: 24 W
- » Sehr geräuscharm, erhitzt sich nicht und vibriert nicht
- » Gewicht Nagelfräser: 341 g
- » Gewicht Manipel: 155 g
- » Spannung: 110 - 220 V
- » Class II 50/60 Hz.

Umfasst: 6 Accessoires + 6 Schleifpapiere  
Include: 6 accessori + 6 mole

- » *Potente e silenzioso*
- » *Design compatto perfetto per i viaggi*
- » *Molto leggero*
- » *Velocità: 30.000 RPM*
- » *Potenza: 24 W.*
- » *Molto silenzioso, non si riscalda né vibra*
- » *Peso tornio: 341 g*
- » *Peso della fresa: 155 g*
- » *Voltaggio: 110 - 220 V*
- » *Classe II 50/60 Hz*



## Ersatzteile für Nagelfräser Ricambi per torni



- » Bohrfutter-Adapter für Schleifzylinder  
» Mandrino adattatore per smerigliatori

REF. 06779

- » Polierbürste  
» Ø 0,65  
» Scovolino per lucidare  
» Ø 0,65

REF. 06780

- » Steinkegel Filz  
» Ø 0,6  
» Cono in pietra con feltro  
» Ø 0,6

REF. 06781



- » Steinfräser in Fassform  
» Ø 0,6  
» Fresa in pietra con forma a botte  
» Ø 0,6

REF. 06782

- » Steinfräser konisch  
» Ø 0,4  
» Fresa in pietra conica  
» Ø 0,4

REF. 06783

- » Diamantfräser mit runder Spitze  
» Fresa diamantata punta tonda

REF. 06784



- » Steinfräser in Fassform  
» Fresa diamantata forma cilindrica

REF. 06785

- » Diamantfräser zylindrische Fassform  
» Fresa diamantata forma cilindrica a botte

REF. 06786

- » Diamantfräser zylindrische Fassform  
» Fresa diamantata forma cilindrica a botte

REF. 06787



## Ersatzteile für Nagelfräser Ricambi per torni



- » Diamantfräser  
zylindrische
- » Fresa diamantata  
forma cilindrica a  
botte

REF. 06788

- » Keramikfräser Fassform  
Durchmesser
- » Fresa ad ago diamantato

REF. 06789

- » Diamantfräser Nadel
- » Fresa lucidante in silicone

REF. 06790



- » Keramikfräser  
Fassform mit  
runder Spitze
- » Ø 0,66
- » Fresa in ceramica a  
botte diametro
- » Ø 0,66

REF. 06791

- » Silikon-Fräser zum  
Polieren Korn
- » Ø 0,66
- » Fresa in ceramica
- » a a botte punta tonda
- » Ø 0,66

REF. 06792

- » Keramikfräser Nadelform  
Durchmesser
- » Ø 0,23
- » Fresa in ceramica ad ago  
diametro
- » Ø 0,23

REF. 06793



- » Keramikfräser konisch
- » Ø 0,6
- » Fresa in ceramica conica diametro
- » Ø 0,6

REF. 06794

- » Wolframfräser blau konisch
- » Ø 0,6
- » Fresa conica in tungsteno blu
- » Ø 0,6

REF. 06795





**Kit Accessoires**  
**Kit accessori**

- » 6 Accessoires + 6 Schleifpapiere  
 » 6 accessori + 6 mole

1  
u.m.vta

500  
box

REF. 06626



**Dispenser 100 Schleifzylinder**  
**Dispenser 100 cilindri smerigliatori**

1  
u.m.vta

30  
box

- » Fein  
 » Härte: 180

REF. 06627

- » Mittel  
 » Härte: 120

REF. 06628

- » Grob  
 » Härte: 80

REF. 06629

- » Fini  
 » Durezza: 180

- » Medi  
 » Durezza: 120

- » Spessi  
 » Durezza: 80



**Nagelfräser PROMED 620**  
**Tornio PROMED 620**

**REF. 04103**

- » Leistung: 21W
- » Bidirektionaler Nagelfräser mit 10 Accessoires und 30 Schleifpapieren
- » Der kleinste professionelle Tisch-Nagelfräser auf dem Markt
- » Geeignet für die Behandlung von Finger- und Zehennägeln sowie von falschen Fingernägeln, mit Gel oder Acryl
- » Beseitigt problemlos Schwielen und Verhärtungen
- » Reduzierte Größe: 11 x 9 x 8 cm
- » Resistent gegen Azeton mit Motorkühlung (75g)
- » Auflagerstütze Nagelfräser, in der Basis integriert
- » Enthält verschiedene Fräsen und Zwingen (10 Accessoires + 30 Schleifpapiere)
- » Automatischer Schnellverschluss für Standard-Fräsen oder Zwingen von 2,25 mm
- » Schalter mit Staubschutz
- » Drehzahl stufenlos einstellbar bis 20.000 rpm
- » Spannung: 115-230 V~
- » Frequenz 50/60 Hz

- » Potenza: 21W.
- » Tornio a doppio senso di rotazione con 10 accessori e 30 mole
- » Il più piccolo tornio professionale da banco sul mercato
- » Adatto per il trattamento delle unghie di piedi e mani, unghie finte in gel o acriliche
- » Rimuove facilmente calli e duri
- » Dimensioni ridotte: 11 x 9 x 8 cm
- » Resistente all'acetone con motore raffreddato (75g)
- » Staffa di appoggio del tornio integrata nella base
- » Include diverse frese e punte (10 accessori + 30 mole)
- » Sgancio rapido automatico per frese o punte standard da 2,25 mm
- » Interruttore con protezione antipolvere
- » Giri regolabili senza interruzioni fino a 20.000 rpm
- » Voltaggio: 115-230V~
- » Frequenza 50/60 Hz

**Nagelfräser PROMED PERFECT**  
**Tornio PROMED PERFECT**

**REF. 03222**

- » Leistung: 21 W
  - » 12,000 rpm
  - » Bidirektional
  - » 10 Accessoires + 30 Schleifpapiere + 1 Bürste
  - » Eingebautes Kaltlicht zur Beleuchtung des Arbeitsbereichs
  - » Spannung: 220-230 V~
  - » Frequenz 50 Hz
- » Potenza: 21 W.
  - » 12,000 RPM
  - » Doppio senso
  - » 10 accessori + 30 mole + 1 scovolino
  - » Luce fredda incorporata per illuminare l'area di lavoro
  - » Voltaggio: 220-230V~
  - » Frequenza 50 Hz



**Nagelfräser MP840 Maniküre/Pediküre**  
**Tornio per manicure/pedicure MP840**1  
u.m.vta4  
box

REF. 06444

**Nagelfräser MP815 Maniküre/Pediküre**  
**Tornio per manicure/pedicure MP815**1  
u.m.vta4  
box

REF. 06443

**Für die Pflege und Behandlung von Fingernägeln, Nagelhaut und Schwielen**

- » Leistung: 9W
- » Batterie AA nicht mitgeliefert
- » Drehzahl: 2 Niveaus von 3.500 / 4.600 rpm
- » Länge des Kabels: 1,5 m
- » Gewicht: 101 g
- » Spannung: 230 V~, 50Hz
- » Verfügt über eine LED-Lampe für eine noch präzisere Anwendung
- » Drehung nach rechts und nach links
- » Ergonomisches Design
- » Geeignet für Diabetiker
- » Stoppt automatisch, wenn der Druck zu hoch ist
- » Mit Tasche zur Aufbewahrung

**Umfasst:**

- » 2 Polierrollen und 2 Schleifrollen
- » 7 hochwertige Accessoires für verschiedene Anwendungen

**Per la cura e il trattamento di unghie, cuticole e duroni**

- » Potenza: 9W.
- » Batteria non inclusa AA
- » Velocità di rotazione: 2 livelli di velocità: 3.500 / 4.600 rpm
- » Lunghezza del cavo: 1,5 m
- » Peso: 101 g
- » Tensione: 230V~, 50Hz
- » Dispone di una luce a LED per un'applicazione più precisa
- » Rotazione a destra e a sinistra
- » Design ergonomico
- » Adatto per diabetici
- » Si ferma automaticamente quando la pressione è troppo alta
- » Con custodia

**Include:**

- » 2 rulli leviganti e 2 rulli lucidanti
- » 7 accessori di alta qualità per diverse applicazioni

**Für die Pflege und Behandlung von Fingernägeln, Nagelhaut und Schwielen**

- » Leistung: 9W
- » Batterie AA nicht mitgeliefert
- » Drehzahl: 2 Niveaus von 3.500 / 4.600 rpm
- » Länge del Kabel: 1,5 m
- » Gewicht: 101 g
- » Spannung: 230 V~, 50Hz
- » Verfügt über eine LED-Lampe für eine noch präzisere Anwendung
- » Drehung nach rechts und nach links
- » Ergonomisches Design
- » Geeignet für Diabetiker
- » Stoppt automatisch, wenn der Druck zu hoch ist
- » Mit Tasche zur Aufbewahrung

**» Per la cura e il trattamento di unghie, cuticole e duroni**

- » Potenza: 9W.
- » Batteria non inclusa AA
- » Velocità di rotazione: 2 livelli di velocità: 3.500 / 4.600 rpm
- » Lunghezza del cavo: 1,5 m
- » Peso: 101 g
- » Tensione: 230V~, 50Hz
- » Dispone di una luce a LED per un'applicazione più precisa
- » Rotazione a destra e a sinistra
- » Design ergonomico
- » Adatto per diabetici
- » Si ferma automaticamente quando la pressione è troppo alta
- » Con custodia

**Ersatzteile für Nagelfräser**  
**Ricambi per torni**

1  
u.m.v.a.

10  
box



REF. 06444



REF. 06443

» Filzkegel  
» Cono in feltro

REF. 02149



» Saphirkegel feinkörnig  
» Cono in zaffiro a grana fine

REF. 02150



» Saphirkegel grobkörnig  
» Cono in zaffiro a grana grossa

REF. 02151



» Saphirscheibe feinkörnig  
» Disco in zaffiro a grana fine

REF. 02152



» Saphirfräser  
» Fresa in zaffiro

REF. 02153



» Nadelschneider  
» Taglia aghi

REF. 02154



» Saphirkegel groß  
» Cono in zaffiro grande

REF. 02155



» Hautschieber  
» Spingi pellicine

REF. 02156



» Zylinderschneider  
» Taglierino cilindrico

REF. 02157



» Saphirscheibe grobkörnig  
» Disco in zaffiro a grana grossa

REF. 02158



» Saphirschneider oval  
» Taglierino ovale in zaffiro

REF. 02159



» Besen  
» Scovolino

REF. 02164



» Beutel 100 Stück Schleifzylinder  
» Sacchetto 100pz cilindri smerigliatura

Mittel · Medi  
REF. 02978

Grob · Spessi  
REF. 02979



» Fräser-Adapter  
» Adattatore per frese

REF. 02165



» Adapter mit 30 Tuben Schleifpapier  
» Adattatore con 30 tubetti smerigliatura

REF. 02160



**Ersatzteile für Nagelfräser**  
**Ricambi per torni**

1 u.m.vta  
10 box



» Schleifer konisch Saphir  
» Smerigliatore conico in zaffiro

REF. 02958

» Fräser spitz Saphir  
» Smerigliatore conico in zaffiro

REF. 02959

» Fräser rund Saphir  
» Fresa smussata in zaffiro

REF. 02960



» Fräser rund Saphir  
» Disco lima in zaffiro

REF. 02961

» Schleifkegel/Filter  
» Cono levigante/filtro

REF. 02962

» Adapter Schleifzylinder  
» Adattatore cilindrico smerigliatura

REF. 02976



» Adapter Schleifzylinder  
» Lucidante silicone medio

REF. 02980

» Adapter Schleifzylinder  
» Lucidante silicone spesso

REF. 02981

» Fräser lang  
» Fresa lunga

REF. 02982



» Schleifer Pediküre  
» Schwielen  
» Smerigliatore per pedicure

REF. 02983



\*Nicht sterilisierbar, weder mit Druck noch mit Temperatur (selbstreinigend, Quarzsterilisator). Nur mit Desinfektionsmittel oder Alkohol desinfizieren

Non sterilizzabile a pressione o temperatura (autopulente, sterilizzatore al quarzo).  
Disinfettabile solo con disinfettante o alcool

**Beutel 100 Stück Schleifzylinder**  
**Confezione da 100 cilindri smerigliatori**

1 u.m.vta  
10 box

Mittel · Medi

Grob · Spessi

REF. 02978

REF. 02979



**Saphirscheibe mittlere Körnung**  
**Disco in zaffiro a grana media**

1 u.m.vta  
12 box

» Für Drehmaschine für Maniküre-Pediküre  
» Per tornio manicure-pedicure

REF. 07237



NEW

### Lupe mit Licht

#### Lente d'ingrandimento con luce



REF. 03821



- » Leistung: 5W
- » Linse 5 Dioptrien
- » Durchmesser Linse: 10,16 cm
- » Beleuchtung: 48 LEDs
- » Schutzabdeckung für Linse, Sockel für Lupenleuchte mit Gewicht zur Verwendung auf dem Tisch
- » Spannung: 220-240V~
- » Frequenz 5 Hz

- » Potenza: 5W.
- » Lente da 5 diottrie
- » Diametro lente: 10,16 cm
- » Illuminazione: 48 led
- » Copriobiettivo protettivo, base da tavolo
- » Voltaggio: 220-240V~
- » Frequenza 5 Hz

### Lupe mit LED-Lampe

#### Lente d'ingrandimento con luce a led



REF. 04948



- » Leistung: 5W
- » Linse 5 Dioptrien
- » 60 SMD-LEDs mit 6 Abstufungsniveaus im Kalt- und Warmmodus
- » 800 Lumen
- » Maximales Licht, mit sehr echter Farbwiedergabe,
- » Lange Lebensdauer und sehr niedriger Verbrauch
- » Der Farbwiedergabeindex beträgt 80%, wodurch die Farben treu wiedergegeben werden
- » Erzeugt keine Wärme
- » Durchmesser Lupenglas 12,7 cm
- » Glasdicke 0,5 bis 2,1 cm
- » 100-240 V AC 50-60 Hz

- » Potenza: 5W.
- » Lente da 5 diottrie
- » 60 led Smd, 6 livelli di graduazione in modalità freddo e caldo
- » 800 lumen
- » Massima luce, con una riproduzione dei colori molto reale,
- » lunga durata e bassissimi consumi
- » Indice di resa cromatica dell'80% che riproduce fedelmente i colori
- » Non genera calore
- » Diametro della lente 12,7 cm
- » Spessore del cristallo da 0,5 a 2,1 cm
- » 100-240V AC 50-60hz



### Lupe mit Licht

#### Lente d'ingrandimento con luce



REF. 04624

REF. 04947

- » Tischlampe Maniküre mit Fuß und Klemme
- » Linse 5 Dioptrien
- » Größe Linse: 100 mm
- » Beleuchtung: 30 LED SMD
- » Spannung: 100-240 V
- » Frequenz: 50/60 Hz
- » Maximale Leistung: 6 W
- » Arm Typ Schwannenhals für Lupenständer
- » Rutschfester Clip für Tisch mitgeliefert
- » Verwendung in Innenräumen
- » 560 Lumen für den professionellen Gebrauch

- » Lampada da tavolo per manicure con piede e morsetto
- » Lente da 5 diottrie
- » Dimensione della lente: 100 mm
- » Illuminazione: 30 led smd
- » Voltaggio: 100-240V
- » Frequenza: 50/60 Hz
- » Potenza massima: 6W.
- » Braccio direzionabile per porta lente d'ingrandimento
- » Clip antiscivolo da tavolo inclusa
- » Uso interno
- » 560 lumen per uso professionale



Mit Extrazubehör zur Befestigung am Tisch

Con accessorio extra per l'aggancio al tavolo

**Lupe mit Licht****Lente d'ingrandimento con luce**

- » Leistung: 22W
  - » Größe der Linse: 12,7 cm
  - » Schutzabdeckung für Linse
  - » Schwenkbarer Arm für Lupenständer
  - » Schraubzwinde für Tisch mitgeliefert
- 
- » Potenza: 22W.
  - » Dimensione della lente: 12,7 cm
  - » Coprilente protettivo
  - » Braccio direzionabile per porta lente d'ingrandimento
  - » Morsetto per il tavolo incluso

**Lupe LED SMD****Lente d'ingrandimento LED SMD**

- » Leistung: 22W
  - » Größe der Linse: 12,7 cm
  - » 60 LED SMD UND 570 LUMEN
  - » Maximales Licht, mit sehr echter Farbwiedergabe, langer Lebensdauer und sehr niedrigem Verbrauch 6W
  - » Erzeugen keine Wärme
  - » 8 Dioptrien
- 
- » Potenza: 22W.
  - » Dimensione della lente: 12,7 cm
  - » 60 LED SMD E 570 LUMEN
  - » Massima luce, con riproduzione dei colori molto reale, lunga durata e bassissimo consumo 6W
  - » Non genera calore
  - » 8 diottrie



3 Dioptrien  
3 diottrie  
**REF. 03815**

5 Dioptrien  
5 diottrie  
**REF. 03816**

8 Dioptrien  
8 diottrie  
**REF. 03817**



3 Dioptrien  
3 diottrie  
**REF. 04107**

5 Dioptrien  
5 diottrie  
**REF. 04108**

8 Dioptrien  
8 diottrie  
**REF. 04109**

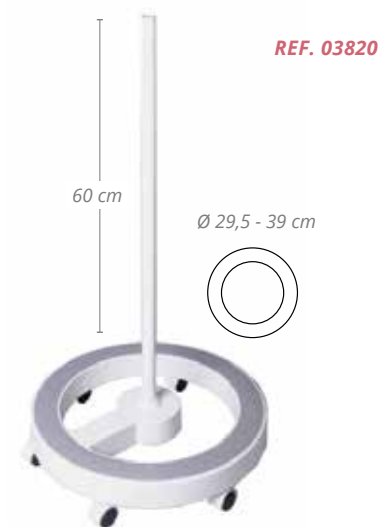
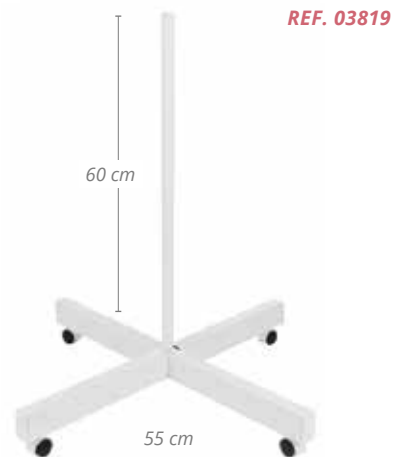
**Pies lupa**  
**Basi per lenti d'ingrandimento****REF. 03820****REF. 03819****REF. 04110**

\* Anpassbar an Ref.-Nr. 03815, 03816, 03817, 04107, 04108, 04109 und 04198  
\* Adattabile ai riferimenti 03815, 03816, 03817, 04107, 04108, 04109 e 04198

**Nagelfeilen einzelner Beutel: gerade**  
**Lime sachetto singolo: dritta**

Dicke: 0,6 cm  
 Spessore: 0,6 cm



Gewicht: 10 gr.  
 Peso: 10 gr.

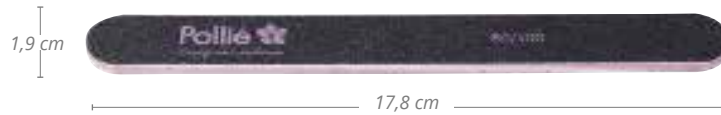

80/100

100/150

REF.06697

REF.06698

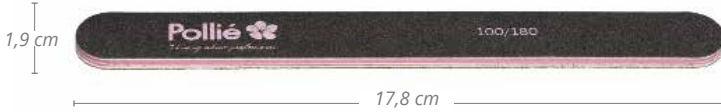

100/180

180/240

REF.06010

REF.06699

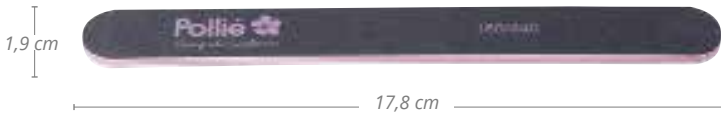

**Nagelfeilen einzelner Beutel: gebogen**  
**Lime sachetto singolo: curva**

Dicke: 0,6 cm  
 Spessore: 0,6 cm



80/100

100/150

REF.06700

REF.06701



100/180

180/240

REF.06011

REF.06702





### Nagelfeilen einzelner Beutel: Halbmond

Lime sachetto singolo: mezza luna

Dicke: 0,6 cm  
Spessore: 0,6 cm



Gewicht: 10 gr.  
Peso: 10 gr.



80/100

100/180

REF.06703

REF.06704



100/180

180/240

REF.06012

REF.06705



### Nagelfeilen einzelner Beutel: Rocket

Lime sachetto singolo: Rombo

Dicke: 0,6 cm  
Spessore: 0,6 cm



REF.06013

### Nagelfeilen einzelner Beutel: quadratisch

Lime sachetto singolo: quadrata

Dicke: 0,6 cm  
Spessore: 0,6 cm

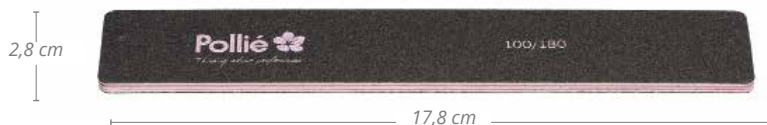

100/180

REF.06014

**Griff aus metall für feile**  
**Manico in metallo per lima**



REF.07222

**Gerade**  
**Dritta**

**NEW**



17,9 cm

**Halbmond**  
**Mezza luna**

**NEW**

REF.07223



17,9 cm

**Pack 48 ersatzteile feile schwarz**  
**Confezione da 48 ricambi lima nera**



**Gerade**  
**Dritta**

**NEW**

#240  
REF.07224

**Halbmond**  
**Mezza luna**

**NEW**

#240  
REF.07225



17,9 cm



17,9 cm

**Pack 48 ersatzteile feile Weiß**  
**Confezione da 48 ricambi lima Bianca**



**Gerade**  
**Dritta**

**NEW**

#100  
 REF.07228

**Halbmond**  
**Mezza luna**

**NEW**

#100  
 REF.07229



17,9 cm



17,9 cm

**Pack 48 ersatzteile feile zebra**  
**Confezione da 48 ricambi lima zebra**



**Gerade**  
**Dritta**

**NEW**

#150  
 REF.07226

**Halbmond**  
**Mezza luna**

**NEW**

#150  
 REF.07227



17,9 cm



17,9 cm

**Nagelfeilen in Pack von 12 STÜCK****Lime in confezione da 12 UNITÀ****Gerade****Dritta**

» Wählen Sie das  
Papiergewicht, was Ihnen  
am besten passt

» Scegli la grammatura più  
adatta a te



100/180

REF.06000

80/80

REF.06020

100/100

REF.06021

180/180

REF.06022

240/240

REF.06023

400/400

REF.06024

600/600

REF.06025

**Gebogen****Curva**

100/180

REF.06001

**Halbmond****Mezza luna**

100/180

REF.06002

**Rocket****Rombo**

100/180

REF.06003

**Quadratisch****Quadrata**

100/180

REF.06004



### Nagelfeilen einzelner Beutel

#### Lime sachetto singolo



#### Gerade Dritta

100/180

REF.06015



#### Gebogen Curva

100/180

REF.06016

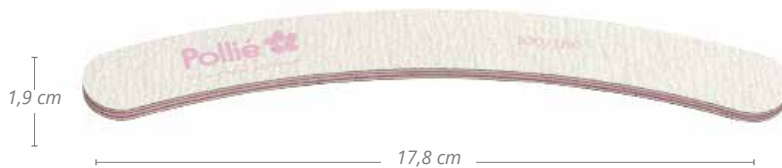

#### Halbmond Mezza luna

100/180

REF.06017



#### Rocket Rombo

100/180

REF.06018



#### Quadratisch Quadrata

100/180

REF.06019



**Nagelfeilen in Pack von 12 STÜCK**  
**Lime in confezione da 12 UNITÀ**

Dicke: 0,6 cm  
 Spessore: 0,6 cm



1  
u.m.vta

40  
box

**Gerade**  
**Dritta**

100/180

REF.06005



**Gebogen**  
**Curva**

100/180

REF.06006



**Halbmond**  
**Mezza luna**

100/180

REF.06007



**Rocket**  
**Rombo**

100/180

REF.06008



**Quadratisch**  
**Quadrata**

100/180

REF.06009





**Professionelle Nagel-feile schwarz gepolstert**  
**Lima professionale nera imbottita**

Dicke: 0,3 cm  
 Spessore: 0,3 cm



100/180

REF.03427

**Gerade**  
**Dritta**



100/180

REF.03428

**Gebogen**  
**Curva**



100/180

REF.03429

**Quadratisch**  
**Quadrata**



**Professionelle Nagel-feile Zebra-muster gepolstert 12 STÜCK**  
**Lima professionale zebra imbottita 12 UNITÀ**

Dicke: 0,3 cm  
 Spessore: 0,3 cm



100/180

REF.03425

**Gerade**  
**Straight**



100/180

REF.03424

**Gebogen**  
**Curva**



100/180

REF.03426

**Quadratisch**  
**Quadrata**

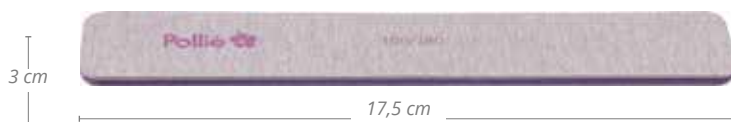

## Nagelfeile und Polierblöcke · Lime e blocchi per lucidare

100/180. Waschbar und desinfizierbar. Komplettes und professionelles Schleifsystem. Extra Haltbarkeit. Doppelt so schnell wie normale Nagelfeilen. Hervorragend für Fingernägel mit Gel und Acryl

100/180. Lavabili e disinfettabili. Sistema abrasivo completo e professionale. Durata extra. Lima 2 volte più veloce delle lime normali. Eccellente per unghie in gel e acriliche

**Pack 12 Nagelfeilen super gepolstert**  
**Confezione da 12 lime super imbottite**

Dicke: 0,8 cm  
 Spessi ness: 0,8 cm



**Gerade**  
**Dritta**



100/180  
 REF.06358

100/180  
 REF.06360

**Gebogen**  
**Curva**



100/180  
 REF.06359

100/180  
 REF.06361

**Packung mit 50 Nagelfeilen. Professionelle Verwendung**  
**Confezione da 50 lime. Uso professionale**

Dicke: 0,13 cm  
 Spessore: 0,13 cm



- » Komplettes und professionelles Schleifsystem
- » Extra Haltbarkeit
- » Dicke: 0,13 cm
- » Doppelt so schnell wie konventionelle Nagelfeilen
- » Hervorragend für Fingernägel mit Gel und Acryl

- » Sistema abrasivo completo e professionale.
- » Durata extra.
- » Lima 2 volte più veloce delle lime convenzionali.
- » Eccellente per unghie in gel e acriliche



100/180  
 REF.06812

100/180  
 REF.06813



Nagelfeile schwarz  
 doppelseitig  
 Lima nera 2 lati

Nagelfeile weiß  
 doppelseitig  
 Lima bianca 2 lati





**Amerikanische Nagelfeilen schwarz**  
**Confezione lime americane nere**

Dicke: 0,1 cm  
 Spessore: 0,1 cm



100/180

REF.01027

**Pack 12 Nagelfeilen gepolstert schwarz**  
**Confezione da 12 lime imbottite nere**

Dicke: 0,3 cm  
 Spessore: 0,3 cm



100/180

REF.01030



100/180

REF.01421

**Nagelfeilen einzelner Beutel**  
**Lime sacchetto singolo**

Dicke: 0,4 cm  
 Spessore: 0,4 cm



100/180

REF.01200

**Pack 12 professionelle Nagelfeilen Zebrawmuster super gepolstert**  
**Confezione da 12 lime professionali super imbottite**

Dicke: 0,3 cm  
 Spessore: 0,3 cm

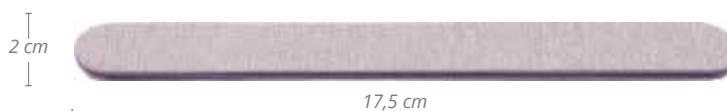

100/180

REF.03731

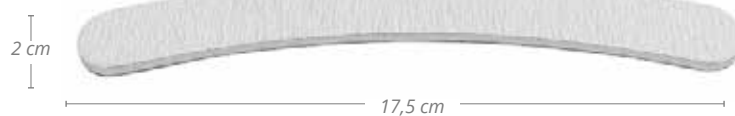

100/180

REF.03730

### Beutel 10 Nagelfeilen aus Pappe Confezione da 10 lime in cartone

» Klein  
» Piccolo

Dicke: 0,12 cm  
Spessi ness: 0,12 cm



REF.00601



» Groß  
» Grande

Dicke: 0,12 cm  
Spessi ness: 0,12 cm



REF.00602



### Satz 20 Nagelfeilen Ref.-Nr. 601-602 (10 + 10) Set da 20 lime r.601-602 (10 + 10)



Dicke: 0,1 cm  
Spessore: 0,1 cm



REF.00621

### Beutel 5 Stück amerikanische Nagelfeilen rot Confezione da 5 lime americane rosse



Dicke: 0,12 cm  
Spessore: 0,12 cm



REF.01517

### Packung 10 Nagelfeilen, lose Confezione da 10 lime, sfuse

» Groß  
» Grande

Dicke: 0,12 cm  
Spessore: 0,12 cm



REF.01115



» Klein  
» Piccolo

Dicke: 0,12 cm  
Spessore: 0,12 cm



REF.01116





**Perfekte Maniküre,  
FARBIG**

**Manicure perfetta  
CON COLORE**

**Beutel 5 Nagelfeilen verschiedene Farben**  
**Confezione da 5 lime colori vari**

Dicke: 0,6 cm  
Spessore: 0,6 cm



12  
u.m.vta

60  
box

» Eine Seite Glitter, die andere Papiergewicht 180  
» Un lato glitter, l'altro con grammatura 180

180

**REF.06367**

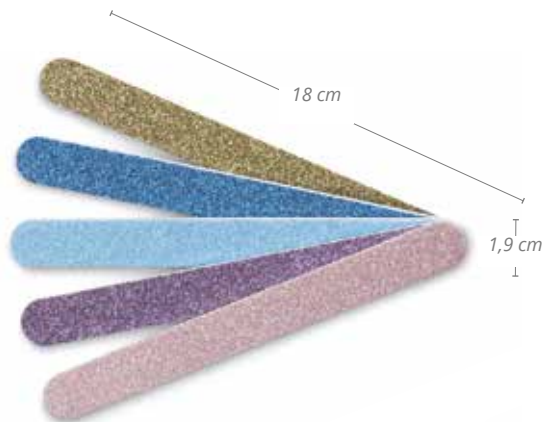

**Beutel 5 Nagelfeilen bedruckt**  
**Confezione da 5 lime fantasia**

Dicke: 0,6 cm  
Spessore: 0,6 cm



12  
u.m.vta

60  
box

» Tieraufdrucke  
» Fantasia animale

180/240

**REF.06365**

» Verschiedene Aufdrucke  
» Fantasia varie

180/240

**REF.06366**

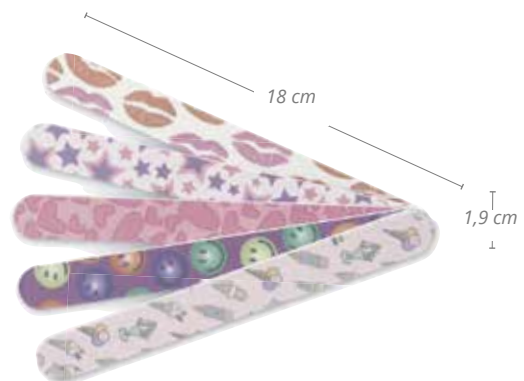
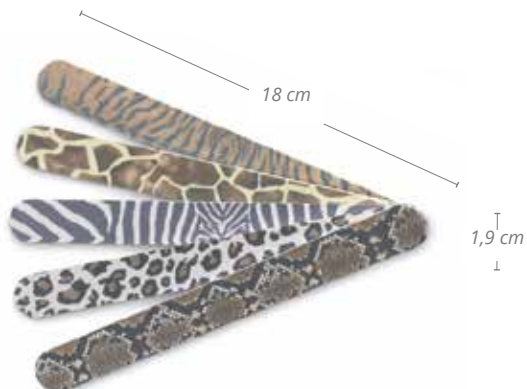

### Verkaufsträger für 42 Nagelfeilen Espositore da 42 lime



180

REF.06416

- » 6 Modelle x 7 Stück.
- » Eine Seite Glitter, die Nagelfeile mit Papiergewicht 180
- » Verschiedene Farben

- » 6 modelli x 7 unità.
- » Un lato glitter, l'altro con grammatura 180
- » Colori assortiti



18 x 1,9 x 0,6 cm

### Verkaufsträger für 48 Nagelfeilen Espositore da 48 lime



180/240

REF.06415

- » 6 Modelle x 8 Stück
- » Tieraufdrucke

- » 6 modelli x 8 unità
- » Fantasia animale



18 x 1,9 x 0,6 cm

### Verkaufsträger für 42 Nagelfeilen bedruckt Espositore da 42 lime fantasia



180/240

REF.06414

- » 6 Modelle x 7 Stück
- » Verschiedene Aufdrucke

- » 6 modelli x 7 unità
- » Fantasia varie



18 x 1,9 x 0,6 cm

**Nagelfeile zum Polieren****Lima per lucidatura**

» 4 Verwendungen

» 4 servizi

Dicke: 0,3 cm  
Spessore: 0,3 cm12  
u.m.vta 360  
box

REF.01029

» 3 Verwendungen

» 3 servizi

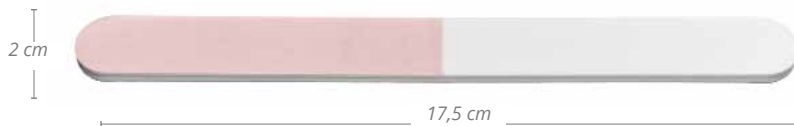
12  
u.m.vta 240  
box

REF.06363

» 3 Verwendungen

» 3 servizi

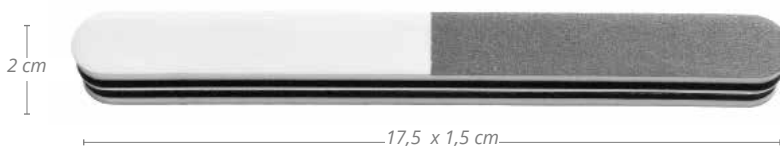
12  
u.m.vta 84  
box

REF.06362

**Nagelfeile rot zum Polieren, Halbmond mit Beutel****Lima rosa per lucidatura a mezzaluna con sacchetto**12  
u.m.vta 60  
box

100/180

REF.06706

**Nagelfeile rot zum Polieren, mit Beutel****Lima rossa per lucidatura con sacchetto**12  
u.m.vta 144  
box

80/80

REF.06712

### Nagelfeile rechteckig zum Polieren Lima rettangolare per lucidatura

12  
u.m.vta

120  
box

REF.01380

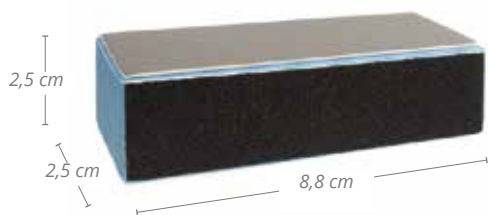

### Nagelfeile Block 4 Seiten Lima a mattoncino a 4 lati

240/320/400/600

12  
u.m.vta

216  
box

REF.06029



### 20 Nagelfeilen Block 3 Seiten 20 lime a mattoncino a 3 lati

» Lila  
» Viola

1  
u.m.vta

46  
box

80/80/100

REF.06030



12  
u.m.vta

216  
box

» Orange  
» Arancioni

100/180/180

REF.06027



1  
u.m.vta

46  
box

» Orange  
» Arancioni

100/180/180

REF.06031



12  
u.m.vta

216  
box

» Weiß  
» Bianco

120

REF.06028

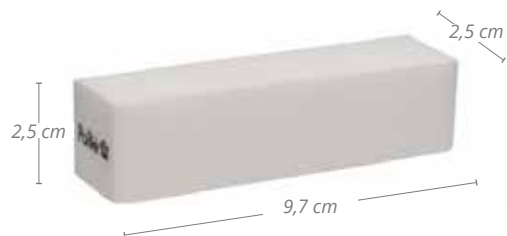

1  
u.m.vta

56  
box

» Weiß  
» Bianco

120

REF.06032



### Box mit 50 Polierblöcken mini Block Confezione da 50 mini mattoncini



Der zweiseitige Polierblock mit Granulation von 120 ist die ideale Nagelfeile zum Nivellieren von großen Oberflächen, auf natürlichen oder falschen Fingernägeln.

*Il mattone lucidante bilaterale con la sua grana da 120 è la lima ideale per uniformare grandi superfici, sia su unghie naturali che su unghie finte.*

- » 2 Seiten
- » Farbe weiß

- » 2 lati
- » Colore bianco

120/120

REF.06708



### Beutel mit 6 Polierblöcken mini Block Confezione da 6 mini mattoncini



- » 2 Seiten
- » Farbe weiß

- » 2 lati
- » Colore bianco

120/120

REF.06707



### Nagelfeilen Glas Lime in cristallo



- » 2 Seiten
- » 2 lati

Lila  
Viola

REF.06630/68

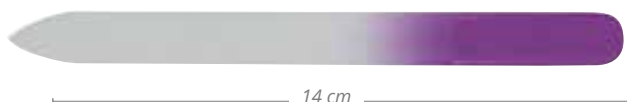
Rosa  
Rosa

REF.06630/70



### Nagelfeile Saphire mit Griff

#### Lime Saphire con manico

12  
u.m.vta

12  
box

REF.00841

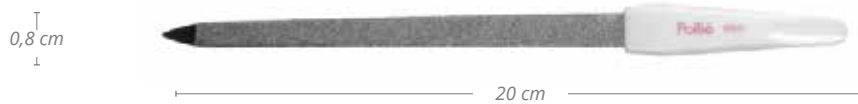

REF.00842



REF.00843



REF.00844



REF.00845



### Handauflagekissen weiß

#### Cuscino poggiamani bianco

1  
u.m.vta

50  
box

» Für eine komfortablere Maniküre, sowohl für den Kunden als auch für den Kosmetiker  
 » Per rendere la manicure più confortevole sia per la cliente che per l'estetista

REF.04969





### Sterilisator trockene Wärme Sanity Security Sterilizzatore a calore secco Sanity Security



REF. 03011

- » Leistung: 400 W
- » 230° C
- » Spannung: 220-240 V~
- » Frequenz 50 Hz

- » Potenza: 400W.
- » 230° C
- » Voltaggio: 220-240V~
- » Frequenza 50 Hz



### Sterilisator keimtötend GX4 Sterilizzatore germicida GX4



- » Leistung: 400 W
- » 20°C - 200°C
- » Ultra flach
- » Keimtötendes Licht erste Qualität

- » Potenza: 400W.
- » 20°C - 200°C
- » Ultra piatto.
- » Luce germicida di alta qualità



REF. 03009/59

REF. RE00891/01



Ersatz-UV-Lampe  
Ricambio lampadina UV

### Sterilisator GX7 Orange Sterilizzatore GX7 arancione



- » Leistung: 75W
- » 20°C - 200°C
- » Fassungsvermögen 120 ccm
- » Mit Quarzkugeln
- » Spannung: 220-240 V~
- » Frequenz 50 Hz

- » Potenza: 75W.
- » 20°C - 200°C
- » Capacità 120 cc
- » Con sfere di quarzo
- » Voltaggio: 220-240V~
- » Frequenza 50 Hz



REF. 03010/64

### Ersatzteile Ricambi

- » Beutel Ersatz-Quarzkugeln
- » Ricambio sfere di quarzo

REF. RE03010/64/01

### Sterilizador EUROSTIL Sterilizzatore EUROSTIL



REF. 07013

- » Mit Quarz
- » Ideal für Utensilien wie Käämme, Scheren

- » Quarzo
- » Ideale per utensili come pettini e forbici



### Dose Quarzkugeln Contentore di sfere di quarzo

500 gr  
REF. 06619

- Zur Sterilisation von Metallwerkzeugen für Friseur- und Schönheitssalons
- » Leistung: 400 W
- » 20°C - 200°C

Per sterilizzare strumenti in metallo sia per parrucchieri che per estetisti

- »
- » Potenza: 400W.
- » 20°C - 200°C



### Sterilizador UV Eurostil Kunststoff Sterilizzatore UV Eurostil in plastica



REF. 06618

- Sterilizador mit UV-Strahlen für alle Art von Werkzeugen für Friseur- und Schönheitssalons
- » Leistung 8 W

Sterilizzatore ultravioletto per tutti i tipi di strumenti, sia per parrucchieri che per estetisti

- » Potenza 8W.



REF. RE06618/01

Ersatz-UV-Lampe  
Ricambio lampadina UV

## Nagelhautzange Tagliacuticole



Die Produktpalette PREMIUM von Pollié ist dafür gedacht, Ihre Erfordernisse maximal zu befriedigen. Hergestellt aus Edelstahl. Pollié Premium bietet die beste Qualität und Leistung mit den neuen Zangen für Fingernägel und Nagelhaut. Die letzten Produktionsschritte erfolgen von Hand, um die perfekte Zange zu erhalten.

La gamma di prodotti PREMIUM di Pollié è pensata e prodotta per soddisfare pienamente le tue esigenze. Realizzati in acciaio inossidabile. Pollié Premium offre la migliore qualità e le migliori prestazioni con le sue nuove pinze per unghie e cuticole, gli ultimi passaggi della loro fabbricazione sono fatti a mano per ottenere una pinza perfetta.

» Federanschlag Grifffläche 5,5 mm  
» Apertura della presa 5,5 mm

REF. 04659



» Federanschlag Grifffläche 4,5 mm  
» Apertura della presa 4,5 mm

REF. 04660

» Federanschlag Grifffläche 5,5 mm  
» Apertura della presa 5,5 mm

REF. 04661



## Nagelknipser Tagliaunghie



» Einfacher Anschlag  
» Presa semplice

REF. 04662

» Einfacher Anschlag  
» Presa semplice

REF. 04663



## Nagelhautzange Tagliacuticole

» Rund, titanblau  
» Rotondo, blu titanio



1 u.m.vta  
12 box

REF.03243

» Titanblau  
» Blu titanio



1 u.m.vta  
12 box

REF.03244

» Titanblau  
» Blu titanio



1 u.m.vta  
12 box

REF.03245

» Titanblau  
» Blu titanio



1 u.m.vta  
12 box

REF.04697

» Mit Verschluss  
» Con sicura

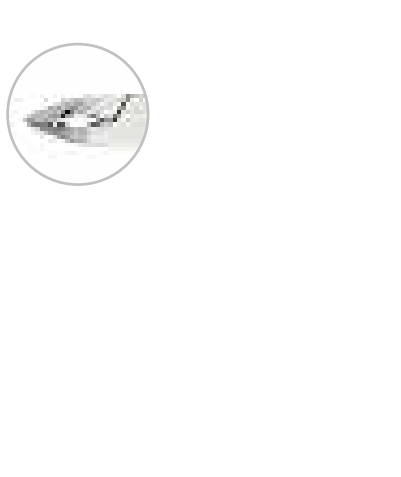

1 u.m.vta  
12 box

REF.01275

## Nagelhautzange Tagliacuticole

- » Grifffläche 5 mm
- » Apertura 5 mm



10 cm

1  
u.m.vta 12  
box

REF.04692



10 cm

1  
u.m.vta 12  
box

REF.01272

- » Eingerastet
- » Incastro



8 cm

1  
u.m.vta 12  
box

REF.02125

1  
u.m.vta 12  
box

REF.03688



11 cm

## Nagelhautzangen Tagliacuticole

- » Karbon
- » Ersatzfeder + Schraube für Zange

- » Carbonio
- » Molla di ricambio + vite pinza



REF.02264

- » Extrafein
- » Edelstahl

- » Superfine
- » Acciaio inossidabile



REF.02679

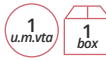

REF.02404



- » Rund
- » Grifffläche 3 mm

- » Rotondo
- » Apertura 3 mm



REF.03018

- » Rund
- » Grifffläche 5 mm

- » Rotondo
- » Apertura 5 mm



REF.03019

- » Grifffläche 4 mm
- » Apertura 4 mm



REF.03039

- » Satinierter Griff
- » Manico satinato



REF.02812

## Nagelhautzange Tagliacuticole

1  
u.m.vta

12  
box

### Chirurgischer Stahl · Acciaio chirurgico

- » Grifffläche 2 mm eingepasst
- » Apertura a incastro 2 mm

REF.02265



- » Grifffläche 4 mm eingepasst
- » Apertura a incastro 4 mm

REF.02266

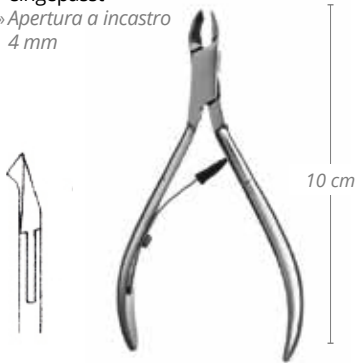

- » Grifffläche 6 mm eingepasst
- » Apertura a incastro 6 mm

REF.02267



- » Ersatzfeder + Schrauben für Zange
- » Molla di ricambio + viti pinza

1  
u.m.vta

1  
box

REF.02405

## Nagelhautzange Tagliacuticole

1  
u.m.vta

12  
box

- » Grifffläche 3 mm
- » Edelstahl

REF.03685

- » Apertura 3 mm
- » Acciaio inossidabile



- » Grifffläche 4 mm
- » Edelstahl

REF.03686

- » Apertura 4 mm
- » Acciaio inossidabile



- » Grifffläche 5 mm
- » Edelstahl

REF.03687

- » Apertura 5 mm
- » Acciaio inossidabile



1  
u.m.vta12  
box**Zange Nagelknipser**  
**Nail clipper**»Edelstahl  
»Acciaio inossidabile

10 cm

REF.01271

»Satinieret  
»Satinato

12 cm

REF. 01276

»Satinieret  
»Satinato

10 cm

REF.02813



11 cm

REF.04693

»Mit Innenfeder  
»Titanblau»Con molla interna  
»Blu titanio

11 cm

REF.04696

»Titanblau  
»Blu titanio

10 cm

REF.03240





**Nagelhautzange**  
Tagliacuticole12  
u.m.Vta12  
box**REF.01069**» Weiß  
» Bianco**REF.01336**» Weiß mit  
Nagelfeile  
» Bianco con lima**REF.02836**» Flieder mit Gummi  
» Lilla con gomma**REF.04411**» Farbig mit Gummi  
» Gomma colorata**REF.01037**» Flieder mit Gummi  
» Lilla con gomma**REF.04589**

**Nagelknipser  
Tagliaunghie**12  
u.m.vta 12  
box» Klein  
» Piccolo

REF.01064

» Groß  
» Grande

REF.01038



6 cm



8 cm

**Nagelknipser mit Depot  
Tagliaunghie con deposito**12  
u.m.vta 120  
box» Klein  
» Piccolo

REF.04408

» Groß  
» Grande

REF.04407



6,6 cm



9 cm

**Nagelknipser für künstliche Fingernägel  
Tagliaunghie per unghie artificiali**1  
u.m.vta 12  
box

REF.01476

**Maniküre-Satz 6 Stück komplett  
Set manicure completo da 6 utensili**1  
u.m.vta 1  
box

REF.02746

**Etui 11 Utensilien für Maniküre  
Astuccio 11 utensili per manicure**1  
u.m.vta 1  
box

REF.04882

» Kapazität für 20 Utensilien

» Capacità per 20 utensili



### Etui Hautzangen und Nagelknipser Fondina in pelle per tagliaunghie

» Klein  
» Piccolo

1 u.m.vta  
10 box

REF.02402



» Groß  
» Grande

1 u.m.vta  
10 box

REF.02403



### Etui Zangen und Nagelknipser, schwarz Fondina per tagliaunghie e pinze, nera

1 u.m.vta  
10 box

REF.02512



### Etui Zangen, kleine Nagelfeilen und Scheren Fondina per pinzette, lime e forbici

1 u.m.vta  
10 box

REF.02401



1 u.m.vta  
48 box

REF.02820



1 u.m.vta  
10 box

REF.02823

N°1

REF.02821



N°2

REF.02822



N°3

REF.02823



N°4

REF.02824



N°5

REF.02825



N°6

REF.02826



N°7

REF.02827



N°8

REF.02828



N°9

REF.02829



## Wie bereite ich den Fingernagel für den Lack vor? Come preparare l'unghia per lo smalto?

- » Die Manikürewerkzeuge, die man verwenden möchte, immer sterilisieren
- » Den Fingernagel feilen und in Form bringen, je nach Geschmack des Kunden, und glätten
- » Befeuchten des Fingernagels mit Wasser
- » Die Nagelhaut mit einem Schieber oder Manikürestäbchen schieben
- » Die Hautreste mit einer Spezial-Hautzange für Maniküre entfernen
- » Mit einer Polierfeile behandeln, damit der Fingernagel nicht fettig aussieht oder glänzt
- » Den Fingernagel erneut befeuchten und dann trocknen

- » *Sterilizzare sempre gli strumenti per manicure da utilizzare*
- » *Lima e modella l'unghia, in base al gusto della cliente e uniforme*
- » *Inumidisci l'unghia con acqua*
- » *Spingi le cuticole con uno spingitore o un bastoncino*
- » *Rimuovere le pelli con una pinza speciale per pelli da manicure*
- » *Passare una lima lucidante per lasciare l'unghia senza grasso e senza lucentezza*
- » *Bagna di nuovo l'unghia e asciugala*



### Doppelter Nagelhautschieber Edelstahl Spingicuticole doppio in acciaio inox



1  
u.m.vta

12  
box

REF.04104



1  
u.m.vta

24  
box

REF.04688



1  
u.m.vta

24  
box

REF.04689

### Nagelhautschieber Edelstahl Spingicuticole in acciaio inossidabile



1  
u.m.vta

24  
box

REF.04687



1  
u.m.vta

12  
box

REF.04105

## Fingernagelbürste Spazzolino per le unghie

» Rosa mit Griff  
 » Rosa con manico



REF.06753



» Weiß mit Griff  
 » Bianco con manico



REF.06754



» Groß, zwei Seiten  
 » Grande a due lati

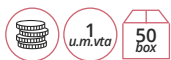

REF.00132



» Doppelt spezial  
 » Doppio speciale



REF.02185



» Mit Griffen, groß  
 » Con manici grandi



REF.00774



» Mit Griffen, klein  
 » Con manici piccoli



REF.00792



**Schale Edelstahl Maniküre**  
**Ciotola per manicure in acciaio**  
**inossidabile**

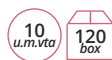

325 ml

REF.03732



Ø 10 cm

**Schale spezial Maniküre**  
**Ciotola speciale per manicure**



REF. 00889



**Schale Fingeranfeuchter naturfarben, ergonomisch**  
**Ciotola ergonomica per le dita in colore naturale**

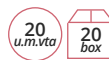

REF.03399



**Rundpunkt ohr- und nasenschere**  
Forbici per naso e orecchie punta tonda



NEW



4"

REF.07087

**Baby scissors point roma**  
Forbici neonato point roma



NEW



3.5"

REF.07088

**3 In 1 pinching forceps**  
Pinze 3 in 1



NEW



REF.07090

**Professionelle Hautschere gebogen**  
Forbici professionali dritte per cuticole



NEW



REF.07353

**Professionelle Nagelschere gebogen**  
Forbici professionali dritte per unghie



NEW



REF.07354

### Hautschere gebogen

Forbici curve per cuticole



NEW

3.5"

REF.07085



3.5"

REF.04690



3.5"

REF.01270

» Professionel  
» Professionale



REF.01989

» Feine Spitze  
» Professionale



REF.03419



### Nagelschere gebogen

Forbici curve per unghie



NEW



3.5"

REF.07086



3.5"

REF.01269

» Professionell  
» Professionale



3.5"

REF.01990



3.5"

REF.04691



**Beutel Hautschieber**  
**Busta spingi cuticole**

10 u

» Holz  
 » Legno



10 u.m.vta  
 10 box

REF.06567

10 u

» Holz  
 » Legno



10 u.m.vta  
 10 box

REF.01279



10 u.m.vta  
 10 box

REF.02716

50 u

» Kunststoff  
 » Plastica



50 u.m.vta  
 50 box

REF.00121

100 u

» Holz  
 » Legno



100 u.m.vta  
 10 box

REF.06565



REF.06566

100 u

» Holz  
 » Legno



100 u.m.vta  
 10 box

REF.00123

1000 u

» Holz  
 » Legno



1 u.m.vta  
 10 box

REF.04525



1 u.m.vta  
 10 box

REF.04526



1 u.m.vta  
 10 box

REF.04527



## Zange Nagelknipser Pediküre Tagliaunghie pedicure

- » Satinierter Griff
- » Edelstahl

- » Manico satinato
- » Acciaio inossidabile



12 cm

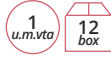

REF.03017

- » Satinierter Griff
- » Edelstahl

- » Manico satinato
- » Acciaio inossidabile



14 cm

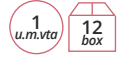

REF.03016

- » Mit Verschluss,  
Hochglanzoberfläche
- » Edelstahl

- » Con sicura. Finitura lucida.
- » Acciaio inossidabile

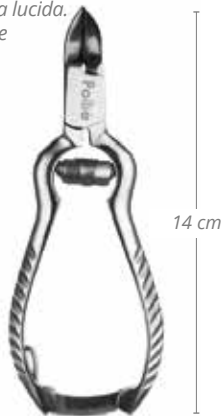

14 cm



REF.01474

- » Mit Verschluss, Hochglanzoberfläche

- » Con sicura. Finitura lucida.



12 cm



REF.01475

- » Matt, mit Verschluss
- » Con sicura. Finitura opaca.



14 cm



REF.04694



- » Matt, mit Verschluss
- » Con sicura. Finitura opaca.



12 cm



REF.04695



### Zange Nagelknipser Pediküre Tagliaunghie pedicure



- » Doppelt gerade mit Federn
- » Doppio dritto con molle



14 cm

REF.07089

- » Schräg mit Federn
- » Obliquo con molle



14 cm

REF.07136

### Nagelknipser Pediküre Tagliaunghie per pedicure

- » Mit Verschluss
- » Titanblau

- » Con sicura
- » Blu titanio



12 cm



REF.03241

- » Mit Verschluss
- » Titanblau

- » Con sicura
- » Blu titanio



14 cm



REF.03242

### Gelenkzange für Podologen Pinza podologica articolata

- » Mit Etui
- » Con custodia

REF.03471



REF.02271



15 cm

**Schale Edelstahl Pediküre**  
*Ciotola per pedicure in acciaio inossidabile*1  
u.m.vta10  
box

7 L

REF.03733

**Beutel Zehentrenner Pediküre**  
*Separadita per pedicure*» 2 Stück  
» 2 unità50  
u.m.vta50  
box

REF.00846

» 2 Stück  
» Silikon  
» 2 unità  
» Silicone1  
u.m.vta12  
box

REF.06755

**Hornhautentferner**  
*Limacalli elettrico*1  
u.m.vta24  
box

Dieser Hornhautentferner ist ein innovatives Gerät, das geschaffen wurde, um trockene, spröde Haut und die Schwielen an den Füßen zu lindern. Die Rolle dreht sich um 360 Grad bei einer Geschwindigkeit von 40 Mal pro Sekunde. Das Gerät arbeitet viel schneller und sicherer als konventionelle Hornhautentferner. Ist dafür gedacht, Hautverdickungen an Füßen und Fersen zu behandeln. Mit Batterien

Questo limacalli è un dispositivo innovativo creato per ammorbidire la pelle secca e ruvida delle callosità dei piedi. Il suo rullo ruota di 360 gradi a una velocità di 40 giri al secondo. Funziona più velocemente ed è più sicuro dei tradizionali limacalli. È progettato per ammorbidire la pelle spessa sui piedi e sui talloni. Con batterie

REF. 04810

**Ersatzteile**  
*Ricambi***Beutel 2 Nagelfeilen**  
*Confezione da 2 lime*

REF. RE04810/01

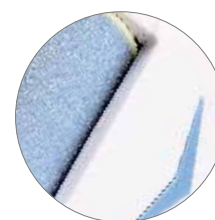

**Crema TASSEL Füße**  
**Crema piedi TASSEL**

1  
u.m.vta

12  
box

» Feuchtigkeitsspendend intensiv  
 » *Crema idratante intensiva*

400 ml

REF.06430



**Peeling TASSEL Füße**  
**Scrub per i piedi TASSEL**

1  
u.m.vta

12  
box

» Mit Aprikosenkern  
 » *Con nocciolo di albicocca*

400 ml

REF.06431



**Flüssiger Enthärter für Verhärtungen und Schwielen**  
**Liquido ammorbidente per calli e duri**

1  
u.m.vta

12  
box

Dank des flüssigen Enthärters von Pollié ist es einfacher, Schwielen und Verhärtungen zu entfernen, um die Füße jung und gepflegt zu halten.

500 ml

REF.04811

*Grazie al liquido ammorbidente Pollié è più facile rimuovere calli e duri per sfoggiare piedi giovani e curati.*



**Hornhautentferner Pediküre**  
**Raschietto per pedicure**



» Kunststoff (waschbar)  
 » Plastica (lavabile)

REF.06033

» Kunststoff (waschbar)  
 » Gebogen

REF.06034



» Mit Metall  
 » Metallico



REF.01068

Transparenter Hornhautentferner aus hartem, widerstandsfähigem Kunststoff. Doppelseitige Nagelfeile aus Keramik



REF.04416

*Raschietto trasparente in plastica rigida e resistente. Lima in ceramica doppio lato*



» Kunststoff, groß  
 » Plastica, grande



REF.04592



REF.01073



**Hornhautentferner aus Metall Pediküre, mit Griff aus Softgummi**  
**Raschietto metallico per pedicure con impugnatura in morbida gomma**



» Weiß  
 » Bianco

REF.06606/58

» Rosa  
 » Rosa

REF.06606/70



**Hornhautentferner von Podorape, doppelseitig, waschbar**  
**Raschietto Podorape doppio lato lavabile**



Hornhautentferner von Podorape, weiß, blau und rosa, doppelseitig, mit einer harten und einer weichen Seite. Waschbar mit unzerstörbarem Griff, für Podologen, ultra-widerstandsfähig und ideal für Diabetiker aufgrund der Wirksamkeit und der Sicherheit des Korns.

*Raschietto Podorape bianco, doppio lato blu e rosa, uno forte e uno delicato. Lavabile con manico infrangibile, studiato per podologi, ultra resistente e ideale per l'utilizzo da parte dei diabetici grazie all'efficacia e alla sicurezza della grana.*

» Weiß  
 » Bianco

REF.06611/58

» Blau  
 » Blu

REF.06611/59

» Rosa  
 » Rosa

REF.06611/70



**Hornhautentferner Pediküre**  
**Raschietto per pedicure**



» Material: Edelstahl  
 » Mit Metallgriff

REF.06709

» Materiale: acciaio inossidabile  
 » Con manico in metallo



**50 Schleifpapiere für Hornhautentferner**  
**50 fogli per raschiacalli**



80  
 REF.06710

180  
 REF.06711

## Bimsstein Pietra pomice

- » Schwarz, klein
- » Mit offener Porenstruktur
- » Piccola, nera
- » Con struttura a poro aperto



REF. 06518

- » Weiß, klein
- » Piccola, bianca



REF. 06517

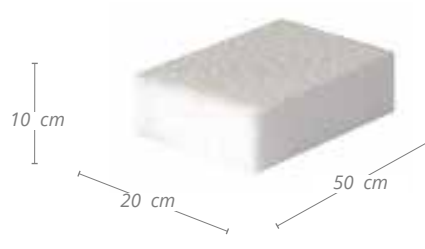
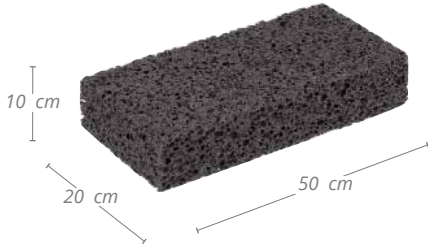

- » Gefärbt, groß
- » Colorata grande



REF. 00942

- » Verschiedene Farben
- » Colori assortiti



REF. 02757

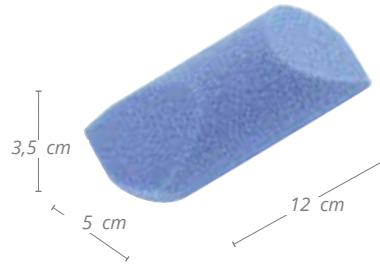

## Bimsstein mit Griff Pietra pomice con manico



REF. 03061



REF. 03062

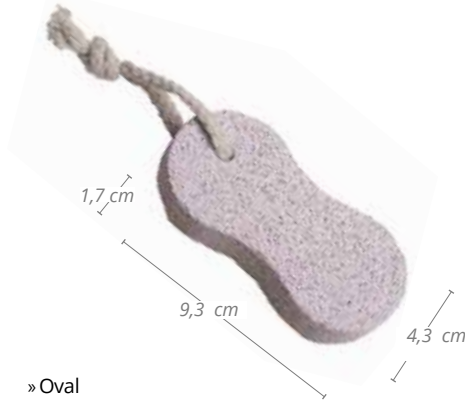

REF. 03063

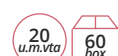

REF. 03065

- » Fisch
- » Pesce

- » Oval
- » Ovale



**Hornhauthobel**  
**Tagliacalli**

- » Rasierklinge  
inbegriffen
- » Con lametta  
inclusa

**REF.01102**

- » Kunststoffgriff
- » Ohne Rasierklinge

» Manico in plastica  
» Senza lama

**REF.01400**

- » Rostfreies Metall
- » Ohne Rasierklinge

» Metallo inossidabile  
» Senza lama

**REF.01401****Dispenser 100 Klingen für Hornhauthobel Pollié**  
**Dispenser da 100 lamette per tagliacalli Pollié**

Austauschklingen aus Stahl für Hornhauthobel. Flache und sehr feine Oberfläche. Sichere Qualitätsklingen mit Schnittgarantie zum Entfernen von überschüssigen Schwielen und/oder Verhornungen an den Füßen, dank seiner zweiseitig Präzisionsklinge und der fein geschrittenen Ränder. Passen sich an alle Standard-Hornhauthobel an.

Lamette di ricambio in acciaio per tagliacalli. Superficie piatta e molto fine. Lamette di qualità con garanzia di taglio e sicurezza, per rimuovere calli in eccesso e/o durizie dei piedi grazie alla lama di precisione e ai due bordi dal taglio di precisione. Si adattano a tutti tagliacalli standard.

- » Maße Box mit 100 Stück: 13 cm x 7 cm  
x 1 cm
- » Gewicht: 72 g
- » Maße Klinge: 2,24 cm x 0,01 cm
- » "Made in Germany"

- » Scatola da 100 unità: 13 cm x 7 cm x 1 cm
- » Peso: 72gr
- » Misure lametta: 2,24 cm x 0,01cm
- » "Made in Germany"

**72 gr****REF.06459**

— 2,24 cm —





**AQUATHERM: 3 IN 1**  
**AQUATHERM: 3 in 1**

- » Leistung: 390 W
- » 3 in 1: Massage durch Vibration und Sprudelbad mit Infrarotwärme
- » Aufheizen des Wassers verstellbar von 20°C bis 48 °C
- » Timer: 20/30/40/50/60 Minuten
- » Am Bildschirm werden die Zeit und die Wassertemperatur angezeigt
- » Automatische Funktionen Infrarot- und Wärmelampe
- » Massageroller zum Massieren der Innenseite der Füße
- » Luftausgänge ergonomisch angebracht
- » Massageroller mit abnehmbarer Basis
- » Doppelt dickes Außengehäuse zur Erhaltung der Wärme
- » Intensive Fußreflexzonenmassage
- » Für Füße bis Größe 46
- » Maße: 38,6 x 24,3 x 45,9 cm

- » Potenza: 390W.
- » 3 in 1: massaggio vibrante e bolle con calore a infrarossi
- » Riscaldamento dell'acqua regolabile da 20°C a 48°C
- » Timer: 20/30/40/50/60 minuti
- » L'ora e la temperatura dell'acqua vengono visualizzate sul display
- » Funzioni automatiche di luce a infrarossi e calore
- » Rulli massaggianti per massaggiare la parte interna dei piedi
- » Prese d'aria posizionate ergonomicamente
- » Rulli massaggianti alla base smontabili
- » Strato esterno a doppio spessore per mantenere il caldo
- » Riflessologia plantare intensa
- » Per piedi fino alla taglia 46
- » Misure: 38,6 x 24,3 x 45,9 cm



REF. 02309

**Reflexmassagegerät**  
**Massaggio riflessivo**

- » Leistung: 60 W
- » Entspannende Massage für die Füße
- » 3 in 1: Aufheizen des Wassers, Sprudelbad und Vibration
- » Intensive Fußreflexologie, Anhaftung für Massage inbegriffen
- » Mit Entwässerung für ein leichteres Leeren
- » Geeignet für Füße bis Größe 44. Rutschfest
- » Automatische Wärmefunktion
- » Länge des Anschlusskabels 175 cm

- » Potenza: 60W.
- » Massaggiatore rilassante per i piedi
- » 3 in 1: riscaldamento dell'acqua, bolle e vibrazione
- » Riflessologia plantare intensa, accessorio per massaggio incluso
- » Con scarico per uno svuotamento più facile
- » Adatto per piedi fino alla taglia 44 Antiscivolo
- » Funzione di riscaldamento automatico
- » Lunghhezza cavo di collegamento 175 cm

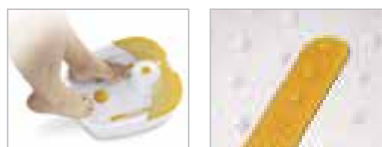

REF. 04588



## Reflexmassagegerät Massaggio riflessivo



REF. 04809

- » Spa-Badewanne für Fußmassage
  - » Leistung: 60 W
  - » Vibrierende Massage mit Sprudelbad
  - » Gummieinlagen rutschfest
- 
- » *Vasca da bagno spa massaggio per i piedi*
  - » *Potenza: 60W.*
  - » *Vibrazione e massaggio con bolle*
  - » *Suola in gomma antiscivolo*

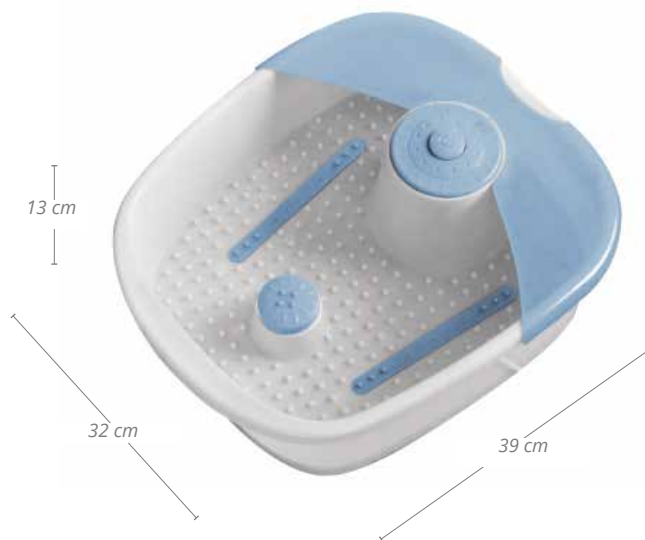

## Schutzhülle Rivestimento protettivo

- » Beutel mit 100 Stück Schutzhüllen aus Polyethylen hoher Dichte für Fußbadewannen.
- » Maße: 48 cm Breite x 45 cm Länge. Seiten aufklappbar + 15 cm, hygienisch.
- » Verhindert den Kontakt der Füße des Kunden mit der Wanne.
- » Transparentes Polyethylen.
- » Nur einmal verwendbar.

- » *Confezione da 100 unità di protezione in polietilene ad alta densità per vasche per pedicure.*
- » *Misure: 48 cm di larghezza x 45 cm di lunghezza. Lati che si dispiegano di 15 cm.*
- » *Evita il contatto tra i piedi del cliente e la vasca da bagno.*
- » *Polietilene trasparente.*
- » *Monouso.*



REF. 06109





## Kunststoffstifte von POLLIÉ

### Matite in plastica POLLIÉ



Weiß · Bianco

REF.03788

- » Schaft aus Kunststoff
- » Cremige Formel, die das Auftragen sanft macht und erleichtert

- » *Corpo in plastica*
- » *Formula cremosa che ammorbidisce e facilita l'applicazione*



Schwarz · Nero

REF.03787



Blau · Blu

REF.03790



Grün · Verde

REF.03789



Braun · Marrone

REF.03792



Grau · Grigio

REF.03791



Braun · Marrone

REF.03794



Hellbraun · Marrone chiaro

REF.03795



Rot · Rosso

REF.03796



Hellviolett · Viola chiaro

REF.03797



Dunkelbraun · Marrone scuro

REF.03798



Dunkelviolett · Viola scuro

REF.03799



Rosa · Rosa

REF.03800

**Lidstift HOLZ POLLIÉ****Matita per gli occhi POLLIÉ in legno**

Ophthalmologisch Getestet  
Oftalmologicamente testato

Eyeliner von Khol für die Benutzung auf der inneren und äußeren Augenlinie. Seine cremige Textur ist mild für die sensible Innenlinie und für die delikaten Stellen der Augen.

*Matita eyeliner Khol da utilizzare sul contorno occhi interno ed esterno. La sua consistenza cremosa è delicata sulla linea interna sensibile e sulle zone delicate degli occhi.*

Schmaler Stift, extrudiert, aus Holz. Anwendung auf der inneren und äußeren Augenlinie.  
*Matita sottile in legno estruso. Applicazione sulla linea degli occhi interna ed esterna*

**REF.06398**

Schwarz Khol · Nero Khol



12,5 cm

Seine hohe Pigmentkonzentration bewirkt, dass die Farbe widerstandsfähig und haltbar am Tränensack ist.  
*La sua alta concentrazione di pigmenti rende il colore resistente e di lunga durata nel condotto lacrimale.*

**REF.06399**

Schwarz · Nero



12,5 cm

**REF.06400****REF.06402**

Braun · Marrone



12,5 cm



Weiß · Bianco



12,5 cm

**REF.06403****REF.06404**

Grün · Verde



12,5 cm



Grau · Grigio



12,5 cm

**REF.06405****REF.06456**

Blau · Blu



12,5 cm



Lila · Viola



12,5 cm

**Lippenstift HOLZ POLLIÉ**  
**Matita per le labbra POLLIÉ in legno**



Feiner Stift extrudiert aus Holz. Anwendung für Lippenkontur und Lippen.  
 Intensiver Lipliner zur Definition der Lippen in nur einem Durchgang. Angenehm, cremig und leicht mit einem Pinsel aufzutragen.  
 Reichhaltige Textur und intensive Farbe, die es Ihnen erlaubt, die neue Art des Auftragens des Lipliners in matter Farbe auszubastern.

*Matita sottile in legno estruso. Applicazione su labbra e contorno labbra.*

*Matita per labbra intensa per definire le labbra in una passata. Si applica in modo piacevole, è cremosa e facile da applicare con un pennello.  
 Texture ricca e colore intenso che ti permettono di provare il nuovo modo di usare la matita per le labbra con un colore opaco.*

REF.06406



Hellbraun  
 Marrone chiaro



12,5 cm

REF.06407



Weinrot  
 Vino



12,5 cm

REF.06408



Mittelbraun  
 Marrone medio



12,5 cm

REF.06409



Dunkelrot  
 Rosso scuro



12,5 cm

REF.06410



Rosa  
 Rosa



12,5 cm

## Augenbrauenstift Holz POLLIÉ

### Matita per le sopracciglia POLLIÉ in legno

Ophthalmologisch Getestet  
Oftalmologicamente testato



Feiner Stift, extrudiert aus Holz. Anwendung auf die Augenbrauen

Augenbrauenstift mit mischbarer trockener Textur zum perfekten Definieren, Färben und Auffüllen der Augenbrauen mit Strichen in milden Farben. Verwenden Sie die Abdeckung der Bürste, um die Augenbrauen vor der Anwendung zu kämmen und sogar, um die aufgetragene Farbe zu mischen. Natürliches Finish, hält mehrere Stunden.

*Matita sottile in legno estruso. Applicazione sulle sopracciglia*

*Matita per le sopracciglia sfumabile a secco per definire, colorare e riempire perfettamente le sopracciglia con pennellate di colori tenui. Usa il cappuccio del pennello per pettinare le sopracciglia prima dell'applicazione e anche per sfumare il colore applicato. Finitura naturale che dura per ore.*

REF.06396



Dunkelbraun  
Marrone scuro



12,5 cm

REF.06397



Hellbraun  
Marrone chiaro



12,5 cm

REF.06455



Schwarz  
Nero



12,5 cm

## Verkaufsträger für Lid-, Augenbrauen- und Lippenstifte

### Espositore per matite per occhi, sopracciglia e labbra



» 16 Zellen  
» 16 celle

REF.06807

» Leer  
» Vuoto

REF.06807/01



**Wimpernmaske**  
**Mascara**Ophthalmologisch getestet  
Oftalmologicamente testato1  
u.m.vta12  
box**Glamglam Volumen und Intensität**  
**Glamglam volume e intensità**

REF.06826

**Intensifier schwarz intensiv**  
**Intensifier nero intenso**

REF.06827

Waterproof  
4D Volumen  
Mit natürlichen Wachsen*Resistente all'acqua*  
*Volume 4D waterproof*  
*Con cere naturali*Hauttest natürliche  
Wachse  
X3 schwarz*Testato dermatologico Cere*  
*naturali*  
*X3 nero*



## Abschminkschwamm Zellulose

### Spugna struccante in cellulosa

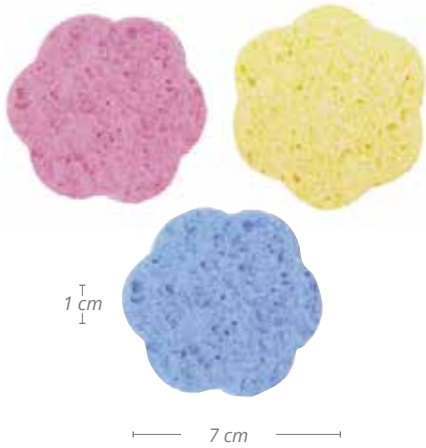

12  
u.m.vta

360  
box

● ● ●

REF.01355

REF.01355/77

Unverpackt  
Sfuse

REF.01355/59/01

12  
u.m.vta

2160  
box

REF.01355/70/01

REF.01355/77/01



12  
u.m.vta

240  
box

● ● ●

REF.01938

REF.01938/77

Unverpackt  
Sfuse

REF.01938/59/01

1080  
u.m.vta

1080  
box

REF.01938/70/01

REF.01938/77/01

## Natürlicher Schwamm

### Spugna naturale

» Natürlicher Schwamm Bad  
» Spugna naturale per il bagno

1  
u.m.vta

16  
box

REF.02478

» Zum Abschminken, von sanfter Textur,  
indiziert für sensible und empfindliche  
Haut. Hypoallergen

1  
u.m.vta

72  
box

REF.02453

» Per struccare, dalla texture morbida, indicata  
per pelli sensibili e delicate. Ipoallergenico



**Beutel 2 feine flache Abschminkschwämme**  
**Confezione da 2 spugne piatte sottili per rimuovere il trucco**

Beim Trocknen werden sie hart, womit die Keimbildung verhindert wird  
 Quando si seccano, si induriscono evitando la formazione di germi

**Feucht**  
**Umide**



12  
u.m.vta

240  
box

REF.03166



12  
u.m.vta

180  
box

REF.03165

**Beutel Handtuch feiner Abschminkschwamm**  
**Asciugamano spugna sottile per rimuovere il trucco**

12  
u.m.vta

180  
box

REF.03168

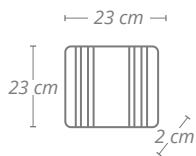

**Schwamm latexfrei - polyurethan**  
**Spugna senza lattice - poliuretano**

1  
u.m.vta

15  
box



Sie können den Schwamm feucht oder trocken verwenden. Trocken eignet er sich für das Auftragen von Make-up in Puderform wie Kompaktpuder, Rouge, Lidschatten... Feucht dient er zum Auftragen von Unterlagen, Cremes, Lotionen und sonstigen flüssigen Make-up-Produkten.

Puoi usare la spugna bagnata o asciutta. Per uso a secco, è adatta per applicare i trucchi in polvere come ciprie compatte, fard, ombretti, ecc... Per uso bagnato, è adatta per applicare fondotinta, creme, lozioni e altri prodotti per il trucco liquidi.

NEW

REF.07128



NEW

REF.07127



**Beutel 2 zylindrische Make-up-Schwämme**  
 Confezione da 2 spugne cilindriche per il trucco

12  
u.m.vta

180  
box

REF.03167

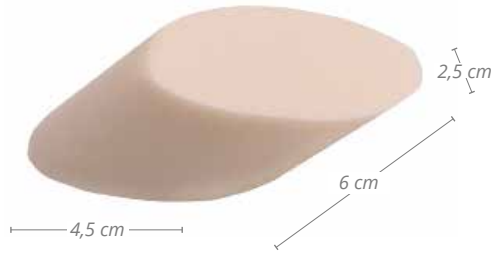

**Make-up -Schwämme**  
 Spugnette per il trucco

1  
u.m.vta

12  
box

REF.03559



» Make-up-Schwamm  
 rosa Satz-4

12  
u.m.vta

240  
box

REF.01361

» Set di spugnette per  
 trucco rosa - 4u

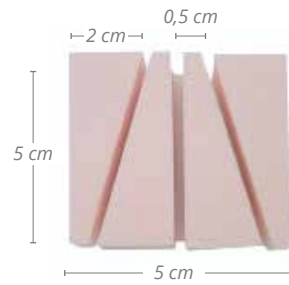

» Látex NBR  
 » Lattice NBR

12  
u.m.vta

360  
box

REF.01356

» Látex NBR  
 » Lattice NBR

12  
u.m.vta

240  
box

REF.02898

» Látex NBR  
 » Lattice NBR

12  
u.m.vta

240  
box

REF.02897



### Make-up-Schwamm Latex NBR Spugnetta per trucco in lattice NBR



REF.01409



REF.02899

### Beutel 2 Make-up-Schwämme Latex Confezione da 2 spugnette per il trucco in lattice



REF.01410



REF.01357

### Schwamm Make-up Spugnetta per il trucco

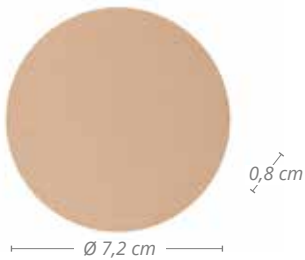

REF.01354

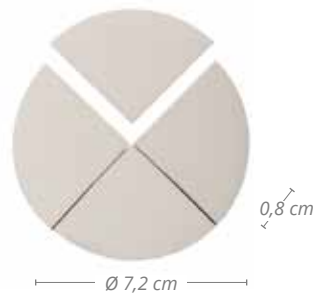

REF.01358

» Beutel 4 Schwämme Herzform  
» Confezione da 4 spugne a cuore

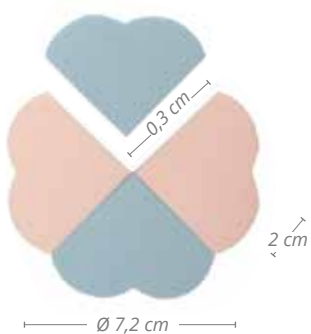

REF.02675

» Beutel 12 Latexschwämme  
» Confezione da 12 spugne in lattice

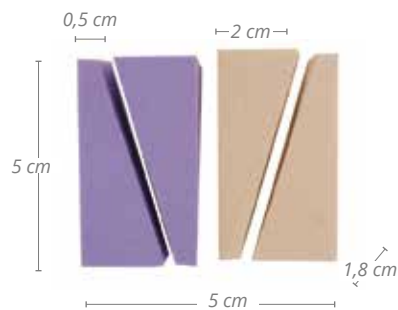

REF.01459

### Beutel Schwämme Make-up Farben Sacchetti di spugne per il trucco colorate

» 8 Schwämme  
» 8 spugne



REF.01481



» 24 Schwämme  
» 24 spugne



REF.02671



» 4 Schwämme  
» 4 spugne



REF.02672



» Satz 3 Schwämme  
+ 2 Quasten



REF.02673

» Set 3 spugne + 2  
applicatori cipria

» 6 Schwämme  
» 6 spugne



REF.02674



» 33 Schwämme  
» 33 spugne



REF.02676



### Make-up -Quaste Applicatori di cipria

» Rosa  
» Rosa



REF.01360



Ø 61

» Mittelgroß  
» Media



REF.01411



Ø 70

» Groß  
» Grande



REF.01359



Ø 85

**ANGLED Rougepinsel**  
Pennello per blush ANGLED



REF.07416



NEW

**Pinsel erröten**  
Pennello per blush



REF.07408



NEW

**Mischpinsel**  
Pennello per sfumare



REF.07418



NEW

**Mischpinsel**  
Pennello per sfumare



REF.07419



NEW

**Mischpinsel**  
Pennello per sfumare



REF.07420

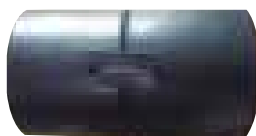

NEW



**Make-up-Pinsel POLLIÉ: Griff aus Kunststoff, Haare synthetisch**  
**Pennelli per il trucco POLLIÉ: manico in plastica, pelo sintetico**



- » PROFESSIONELLE ERGEBNISSE: professioneller Make-up-Pinsel aus synthetischen Borsten von erster Qualität für ein präzises, sanftes und streifenfreies Auftragen. Verwöhnen Sie Ihre Haut mit sanften und pflegeleichten Make-up-Pinseln, die frei von Grausamkeiten gegenüber Tieren sind
- » UNIVERSELL: umfasst eine breite Palette an ovalen Pinseln für die Nutzung mit allen Produkten wie Contouring, Base, Korrekturmittel für Augenringe, Staub...
- » FLEXIBEL: biegsam konzipiert, um ein einfaches Auftragen des Make-up an Stellen mit schwierigem Zugang zu bieten
- » SANFTES UND PRÄZISES AUFTRAGEN: die sanften Borsten von hoher Qualität gewährleisten, dass die Produkte wie Unterlagen, Korrekturlösungen, BB-Cremes, Rouges und Pulver gleichmäßig und sanft aufgetragen werden können.

- » RISULTATI PROFESSIONALI - Pennelli per trucco professionali realizzati con setole sintetiche premium per un'applicazione precisa, liscia e senza righe. Coccola la tua pelle con pennelli per il trucco morbidi, facili da pulire e senza crudeltà per gli animali.
- » MULTIUSO - Comprende un'ampia gamma di pennelli ovali da utilizzare con tutti i prodotti come contouring, fondotinta, correttore, cipria...
- » FLESSIBILI - Progettati per piegarsi al fine di offrire una facile applicazione del trucco in aree difficili da raggiungere.
- » APPLICAZIONE DELICATA E PRECISA - Le setole morbide e di alta qualità assicurano che prodotti come fondotinta, correttori liquidi, creme BB, fard e ciprie possano essere applicati in modo uniforme e delicato.

- » Rund groß
- » Rotondo grande



REF.06059



- » Rund mittelgroß
- » Rotondo medio



REF.06060



- » Oval groß
- » Ovale grande



REF.06061



- » Oval, klein
- » Ovale piccolo



REF.06062



- » Rund mini
- » Rotondo mini



REF.06063



- » Satz 5 Bürsten
- » Set 5 pennelli



REF.06064

### Lidschatten Pinsel

Pennello per ombretto



N°7

REF.07393

NEW



N°6

REF.07394

N°5

REF.07395



N°4

REF.07396

N°3

REF.07397



N°2

REF.07398

N°1

REF.07399



### Eyeliner-Pinsel

Pennello per eyeliner



REF.07400



NEW

### Eyeliner Mischpinsel

Pennello per sfumare l'eyeliner



REF.07401



NEW



### Heil- / Unschärfepinsel

*Pennello correttivo / sfocato*



REF.07402

N°5

NEW



N°4

REF.07403

N°3

REF.07404



N°2

REF.07405

N°1

REF.07406



### Konturieren von Bürstennasenschatten

*Pennello per contouring naso ombretti*



REF.07407



NEW

### Make-up Concealer Pinsel

*Pennello correttore per il trucco*



REF.07409



NEW

### Einziehbare Lippenbürste

*Pennello per labbra retrattile*



REF.07410



NEW

**Brauenmischpinsel**  
Pennello per sfumare le sopracciglia



REF.07411



NEW

**Augenbrauen-Kammbürste**  
Pennello per sopracciglia



REF.07417



NEW



**FOUNDATION Pinsel**  
Pennello FOUNDATION

NEW



REF.07413

N°4

REF.07412

N°3



N°2

REF.07414

N°1

REF.07415





## PINSEL VON KABUKI PENNELLI KABUKI

Die Pinsel von Kabuki gelten als die besten für das Auftragen von Make-up, Lidschatten oder Rouge. Sie verschaffen ein Gefühl der extremen Sanftheit wie eine Liebkosung auf der Haut des Kunden und ermöglichen ein Finish wie ein Filmstar. Sie sind unverzichtbar für Make-up-Profis.

*I pennelli Kabuki sono considerati i migliori per applicare trucco, ombretto o fard. Forniscono una sensazione di estrema morbidezza come una carezza sulla pelle della cliente e permettono una finitura cinematografica. Sono indispensabili per un professionista del trucco.*

### Professionelle Pinsel KABUKI Pennelli professionali KABUKI

Synthetisch  
Sintetico



» Konisch  
» Conico

REF.04094

» Eckig  
» Angolo

REF.04095



» Rund  
» Rotondo

REF.04096

» Flach  
» Piatto

REF.04097



» Konisch  
» Conico

REF.04111

» Schatten konisch  
» Conico per ombretto

REF.04098



» Schatten eckig  
» Angolare per ombretto

REF.04099

» Schatten flach  
» Piatto per ombretto

REF.04101



**Pinsel KABUKI**  
**Pennelli KABUKI**Synthetisch  
Sintetico1  
u.m.vta12  
box» Rund  
» Rotondo

REF.04703

» Schräg  
» Obliquo

REF.04704

» Stumpf  
» Smussato

REF.04705

Synthetisch  
Sintetico1  
u.m.vta12  
box» Rund  
» Rotondo

REF.04100

» Schwamm Latex  
» Spugna in lattice

REF.04102

» Konisch klein  
» Conico piccolo

REF.04112

» Rund  
» Rotondo

REF.04113

» Schmal  
» Stretto

REF.04114

» Flach gerade  
» Piatto dritto

REF.04115



## Make-up-Pinsel Pennello per il trucco



» Puderpinsel  
» Pennello per cipria

REF.07390

» Kontur- / Farbpinsel  
» Pennello per contouring  
/ coloret

REF.07391

» Illuminator-Pinsel  
» Pannello illuminatore

REF.07392



## Pinsel KABUKI Pennello KABUKI

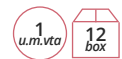

» Make-up-Pinsel Haar synthetisch/Taklon  
» Durchmesser Haar: 27,5 mm  
» Verpackung: einzelner Beutel aus Kunststoff  
» Ideal für unterwegs weil platzsparend

» Pennello per il trucco con setole sintetiche/Taklon  
» Diametro delle setole: 27,5 mm  
» Confezione: busta di plastica individuale  
» Ideale da trasportare senza occupare spazio

REF.03561



## Kosmetikbürste und Make-up-Pinsel KABUKI NATÜRLICHES HAAR Pennello cosmetico e pennelli per il trucco KABUKI SETOLE NATURALI

» Kosmetikbürste  
für Handtasche,  
Kunststoffgriff  
» Ziegenhaar

» Pennello cosmetico  
con manico in plastica  
» Setole di capra



REF.01812

» Make-up-Pinsel natürliches Haar  
» Durchmesser Haar: 27,5 mm  
» Packaging: einzelner Beutel aus Kunststoff  
» Ideal für unterwegs weil platzsparend

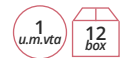

REF.03560

» Pennello per il trucco con setole naturali  
» Diametro delle setole: 27,5 mm  
» Confezione: Busta di plastica individuale  
» Ideale da trasportare senza occupare spazio



## Pinsel mit Holzgriff

### Pennelli con manico in legno



- » Tönungscreme
- » Ziegenhaar

REF.02884

- » Rouge
- » Ziegenhaar

REF.02885

- » Mattifier
- » Pelo di capra

- » Fard
- » Pelo di capra



- » Schattierer
- » Eichhörnchenhaar

REF.02886

- » Schattenpinsel
- » Eichhörnchenhaar

REF.02887

- » Sfumatore
- » Pelo di scoiattolo

- » Pennello per ombretto in pelo di scoiattolo



- » Augenpinsel
- » Marderhaar

REF.02888

- » Schattenpinsel
- » Marderhaar

REF.02889

- » Pennello per gli occhi
- » Setole di zibellino

- » Pennello per ombretto
- » Setole di zibellino



- » Lippenpinsel
- » Marderhaar

REF.02890

- » Lippenpinsel
- » Marderhaar

REF.02891

- » Pennello per labbra
- » Setole di zibellino

- » Pennello per labbra
- » Setole di zibellino



- » Augenpinsel
- » Marderhaar

REF.02892

- » Pinsel Schwamm Latex
- » Pennello in spugna di lattice

REF.02893

- » Pennello per gli occhi
- » Setole di zibellino



- » Pinsel für Maske
- » Nylon

REF.02894

- » Professioneller Kamm Maske
- » Pinsel Wildschweinborsten

REF.02895

- » Pennello per mascara
- » Nylon

- » Pettine professionale mascara
- » Setole di cinghiale



## Pinsel mit Holzgriff

### Pennelli con manico in legno



- » Kosmetikbürste Tönungscreme
- » Ziegenhaar

REF.01814

- » Kosmetikbürste Rouge
- » Ziegenhaar

REF.01815

- » Pennello cosmetico opacizzante
- » Setole di capra

- » Pennello cosmetico per fard
- » Setole di capra



- » Kosmetikbürste Schwamm
- » Pennello cosmetico spugna

REF.01816

- » Kosmetikbürste Augen
- » Marderhaar

REF.01817

- » Pennello cosmetico per gli occhi
- » Setole di zibellino



- » Schattenbürste
- » Ziegen- und Ponyhaar

REF.01818

- » Kosmetikbürste Lippen
- » Ziegen- und Ponyhaar

REF.01819

- » Pennello cosmetico per ombretto
- » Setole di capra

- » Pennello cosmetico per le labbra
- » Setole di capra



- » Schattenbürste
- » Ziegen- und Ponyhaar

REF.01821

- » Bürste Pinsel/Kamm Maske
- » Wildschweinborsten

REF.01820

- » Pennello cosmetico per ombretto
- » Setole di capra

- » Pennello/peppine mascara
- » Setole di cinghiale



## Ideal für Flüssig-Make-up

### Ideale per trucco fluido

Synthetisch  
Sintetico

- » Kunststoffgriff
- » Manico in plastica

REF.04511

- » Holzgriff
- » Manico in legno

REF.04512



## Pinsel mit Holzgriff

### Pennelli con manico in legno



- » Pinsel für Tönungscreme
- » Ziegenhaar

REF.01800

- » Pennello mattifier
- » Setole di capra



- » Pinsel für Rouge
- » Ziegenhaar

REF.01801

- » Pinsel für Gesichtsmaske
- » Schweineborsten

REF.01802

- » Pennello per fard
- » Setole di capra

- » Pennello per mascara
- » Setola di maiale



- » Fächerpinsel
- » Ziegenhaar

REF.01803

- » Augenpinsel
- » Marderhaar

REF.01804

- » Pennello a ventaglio
- » Setole di capra

- » Pennello per gli occhi
- » Setole di zibellino



- » Lippenpinsel
- » Marderhaar

REF.01805

- » Schattenpinsel
- » Ziegen- und Ponyhaar

REF.01806

- » Pennello per labbra
- » Setole di zibellino

- » Pennello per ombretto
- » Setole di capra



- » Schattenpinsel
- » Ziegen- und Ponyhaar

REF.01807

- » Pinsel Schwamm Latex
- » Pennello in spugna di lattice

REF.01808

- » Pennello per ombretto
- » Setole di capra



- » Pinsel für Maske
- » Nylon

REF.01809

- » Pinsel-Kamm Maske
- » Wildschweinborsten

REF.01810

- » Pennello per mascara
- » Nylon

- » Pennello/peppine mascara
- » Setole di cinghiale





**Verkaufsträger 66 Kosmetikpinsel**  
**Espositore per 66 pennelli cosmetici**



REF.01466



01800



01804



01801



01805



01802



01806



01803



01807



01808



01809



01810

(6 Stück x Ref.-Nr.) Nähere Informationen über die Pinsel finden Sie auf Seite 675  
 (6 unità x rif.) Per ulteriori informazioni sui pennelli consultare pagina 675

## Pinsel Pennelli

- » Doppelter Schwamm
- » Doppia spugna

12  
u.m.vta

12  
box

REF.01508



- » Pinsel / Schwamm
- » Pennello / Spugna

12  
u.m.vta

12  
box

REF.01509



## Spitzer Temperamatite

- » Normal / dick
- » Normale / spesso

12  
u.m.vta

120  
box

REF.01067



- » Kosmetik-Doppelspitzer
- » Doppio temperamatite cosmetico

12  
u.m.vta

72  
box

REF.06364



## Beutel Applikatoren Schatten Astuccio applicatori ombretto

12  
u.m.vta

120  
box

5 u

REF.01505



- » Farben
- » Colori

12  
u.m.vta

120  
box

5 u

REF.01507



- » Farben
- » Colori

12  
u.m.vta

120  
box

12 u

REF.01506



**Reiniger für Silikon von Make-up-Pinseln**  
 Detergente in silicone per pennelli da trucco

1  
u.m.vta

12  
box

REF.04706



**Rundes Etui 7 Make-up-Pinsel mit Spiegel**  
 Astuccio rotondo 7 pennelli trucco con specchio

1  
u.m.vta

6  
box

REF.03562



### Satz 12 Kosmetikpinsel Set di 12 pennelli cosmetici



» Enthält: 02884, 02885, 02886, 02887, 02889, 02890, 02891, 02892, 02893, 02894, 02895  
 » Contiene: 02884, 02885, 02886, 02887, 02889, 02890, 02891, 02892, 02893, 02894, 02895

REF. 02896

Nähere Informationen über die Pinsel finden Sie auf Seite 673

Per ulteriori informazioni sui pennelli consultare pagina 673



### Etui 7 Make-up-Pinsel synthetische Haare Astuccio 7 pennelli da trucco setole sintetiche



REF.03563



### Etui Kosmetikpinsel (leer) Astuccio per pennelli cosmetici (vuoto)



REF.03564



### Satz 5 Pinsel Set di 5 pennelli



REF.02585



# Wimpern

## CIGLIA

*Komplette Wimpern, Einzelne Wimpern,  
Wimpern zum Ankleben, Augenbrauen...  
Ciglia intere, ciglia singole, ciglia adesive,  
sopracciglia...*



## Einzelne Wimpern POLLIÉ Ciglia POLLIÉ individuali



### Einzelne Wimpern in 4 Schritten:

1. Reinigen Sie Ihre natürlichen Wimpern und die Augenlider, um sie frei von Make-up und Unreinheiten zu halten
2. Entnehmen Sie die Wimpern aus der Box mit der Pinzette Pollié (Ref.-Nr. 06562)
- Tragen Sie einen Tropfen des Klebers auf die Folie auf und befeuchten Sie den Wimpernansatz mit dem Kleber
4. Bringen Sie die Extension auf der natürlichen Wimper nahe der Wimperlinie an, OHNE das Augenlid zu BERÜHREN. Tragen Sie so viele Wimpern auf, wie Sie möchten, um das gewünschte Ergebnis zu erzielen

### Wie entfernen Sie Ihre Wimpern von Pollié?

Zwei Wattebäusche mit dem Wimpernentferner von Pollié imprägnieren. Einen Wattebausch unter die Wimpern und einen anderen darüber anbringen. Sanft reiben, bis sich die Wimpern ablösen.

### Ciglia singole in 4 passaggi:

1. Pulisci le ciglia e le palpebre naturali in modo che siano prive di trucco e impurità
2. Rimuovi le linguette dalla scatola con le pinzette Pollié (rif 06562)
3. Applica una goccia di adesivo sulla pellicola e impregna la base delle ciglia con l'adesivo
4. Posiziona l'estensione sulle ciglia naturali vicino alla linea delle ciglia SENZA TOCCARE la palpebra. Applica tutte le ciglia desiderate per ottenere il risultato desiderato

### Come rimuovere le tue ciglia Pollié?

Imbevi due pezzi di cotone con lo struccante per ciglia Pollié. Metti un batuffolo di cotone sotto le ciglia e un altro sopra. Strofini delicatamente finché le ciglia non si staccano.

» Kurz  
» Schwarz



REF.06508

» Mittellang  
» Schwarz



REF.06509

» Corte  
» Nere

» Medie  
» Nere

» Lang  
» Schwarz



REF.06510

» Gemischt  
» Schwarz



REF.06511

» Lunghe  
» Nere

» Miste  
» Nere

» Kurz  
» Duo



REF.06512

» Mittellang  
» Duo



REF.06513

» Corte  
» Duo

» Medie  
» Duo

» Lang  
» Duo



REF.06514

» Kurz  
» Trio



REF.06515

» Lunghe  
» Duo

» Corte  
» Trio

» Media  
» Trio



REF.06516

» Lang  
» Trio



REF.06519

» Medie  
» Trio

» Lunghe  
» Trio

**Wimpern POLLIÉ schwarz 100% natürlich**  
**Ciglia POLLIÉ nere 100% naturali**

1 u.m.v.a  
50 box



**Komplette Wimpern in 4 Schritten:**

1. Die Wimpern an das korrekte Maß anpassen: die Wimpern nach ihrer natürlichen Wimpernlinie ausrichten und nachschneiden im Falle eines Überschusses
2. Auftragen des Klebers: eine feine Linie Kleber entlang des Streifens auftragen und 20-30 Sekunden warten. Im Falle eines Überschusses an Kleber, verwenden Sie Make-up-Entferner zum Entfernen des überschüssigen Teils
3. Auftragen der Wimpern: bringen Sie sie oberhalb der natürlichen Wimpernlinie an, mit leichtem Druck, bis sie festkleben
4. Schlussbearbeitung: verwenden Sie die Pinzetten von Pollié (Ref.-Nr. 06314) zur Anpassung der Wimpern, so dass sie gut ausgerichtet sind und fest bleiben

**Wie entfernen Sie Ihre Wimpern von Pollié?**

Den Wimpernstreifen losmachen, beginnend am äußersten Ende. Legen Sie die Wimpern in ihre Verpackung zurück für eine spätere Verwendung.

*Ciglia complete in 4 passaggi:*

1. Adatta le ciglia alla misura corretta: allinea le ciglia con la linea delle ciglia naturali e tagliale in caso di eccesso.
2. Applicazione adesivo: applica una sottile linea di adesivo lungo la striscia e attendi 20-30 secondi. In caso di adesivo in eccesso, utilizza uno struccante per rimuovere la parte in eccesso
3. Applicazione delle ciglia: incolla sopra la linea naturale delle ciglia, premendo leggermente fino a quando non si solidificano
4. Ritocco finale: utilizza le pinzette Pollié (rif. 06314) per regolare le ciglia in modo che siano ben allineate e fissate

*Come rimuovere le tue ciglia Pollié?*

*Stacca la striscia delle ciglia partendo dal bordo esterno. Metti le linguette nella loro scatola per un uso futuro*

N°1



REF.06487

N°2



REF.06488

N°3



REF.06489

N°4



REF.06490

N°5



REF.06491

N°6



REF.06492

N°7



REF.06493

N°8



REF.06494

N°9



REF.06495

N°10



REF.06496

## Wimpern POLLÍÉ schwarz 100% natürlich Ciglia POLLÍÉ nere 100% naturali

1 u.m.vta  
50 box



### Komplette Wimpern in 4 Schritten

1. Die Wimpern an das korrekte Maß anpassen: die Wimpern ach ihrer natürlichen Wimpernlinie ausrichten und nachschneiden im Falle eines Überschusses
2. Auftragen des Klebers: eine feine Linie Kleber entlang des Streifens auftragen und 20-30 Sekunden warten. Im Falle eines Überschusses an Kleber, verwenden Sie Make-up-Entferner zum Entfernen des überschüssigen Teils
3. Auftragen der Wimpern: bringen Sie sie mit dem Kleber oberhalb der natürlichen Wimpernlinie an, mit leichtem Druck, bis sie festkleben
4. Schlussbearbeitung: verwenden Sie die Pinzetten von Pollié (Ref.-Nr. 06314) zur Anpassung der Wimpern, so dass sie gut ausgerichtet und fest bleiben

### Wie entfernen Sie Ihre Wimpern Pollié?

Den Wimpernstreifen losmachen, beginnend am äußersten Ende. Legen Sie die Wimpern in ihre Verpackung zurück für eine spätere Verwendung

### Ciglia complete in 4 passaggi

1. Adatta le ciglia alla misura corretta: allinea le ciglia con la linea delle ciglia naturali e tagliale in caso di eccesso.
2. Applicazione adesivo: applica una sottile linea di adesivo lungo la striscia e attendi 20-30 secondi. In caso di adesivo in eccesso, utilizza uno struccante per rimuovere la parte in eccesso
3. Applicazione delle ciglia: incolla sopra la linea naturale delle ciglia, premendo leggermente fino a quando non si solidificano
4. Ritocco finale: utilizza le pinzette Pollié (rif. 06314) per regolare le ciglia in modo che siano ben allineate e fissate

### Come rimuovere le tue ciglia Pollié?

Stacca la striscia delle ciglia partendo dal bordo esterno. Metti le linguette nella loro scatola per un uso futuro

N°11



REF.06497

N°12



REF.06498

N°13



REF.06499

N°14



REF.06500

N°15



REF.06502

N°16



REF.06503

N°17



REF.06504

N°18



REF.06505

N°19



REF.06506

N°20



REF.06507



**Satz 3 einzelne Pinzetten Haar für Haar**  
**Set 3 singole pinzette**



REF.06562

Satz mit 3 Pinzetten für die Anbringung von falschen Wimpern und Wimpern-Extensions. Mit einem bequemen Etui aus Metall  
 Set di 3 pinzette per il posizionamento di ciglia finte ed extension per ciglia. Con una comoda custodia in metallo





#### WELCHE AUGENFORM HABEN SIE?

Die Feststellung der Augenform ist der erste Schritt, um zu entscheiden, welcher Stil von Wimpern für Sie passt.

#### RUNDE AUGEN

Klassische Wimpern, Mischung aus kurzen und langen Wimpern machen den Blick sanfter:

Ref.-Nr.. 02700, 02693, 02695, 04079

#### MANDELAUGEN

Dichte und zu den Spitzen hin feinere Wimpern: Ref.-Nr..

02690, 02691, 02698, 02699, 02701

#### TIEFLIEGENDE ODER KLEINE AUGEN

Wenig dichte und lange Wimpern, um den Blick zu öffnen:

Ref.-Nr.. 02696, 02697, 02692, 02694

#### CHE FORMA DI OCCHI HAI?

Determinare la forma degli occhi è il primo passo per decidere quale stile di ciglia è giusto per te.

#### OCCHI ARROTONDATI

Ciglia classiche, mix di corte e lunghe, ammorbidiscono lo sguardo: rif. 02700, 02693, 02695, 04079

#### OCCHI A MANDORLA

Ciglia dense e sottili verso le estremità: rif. 02690, 02691, 02698, 02699, 02701

#### OCCHI PROFONDI O PICCOLI

Ciglia rade e lunghe per aprire gli occhi: rif. 02696, 02697, 02692, 02694

### Wie verwende ich sie?

#### Come usare?



#### Komplette Wimper Ciglio completo

1. An Ihrem Auge Maß nehmen und den Überschuss abschneiden
2. Tragen Sie eine dünne Linie Kleber entlang des Streifens auf. Zur Anpassung 30 Sekunden warten
3. Mit Hilfe einer Pinzette auf dem Augenlid am Haaransatz der Wimpern anbringen
4. Schminken und fertig!

1. Prendi la misura dell'occhio e taglia la parte in eccesso
2. Applica una sottile linea di adesivo lungo la striscia. Attendi 30 secondi per regolare
3. Con l'aiuto di una pinzetta, posiziona sulla palpebra all'origine delle ciglia
4. Trucca e voilà!

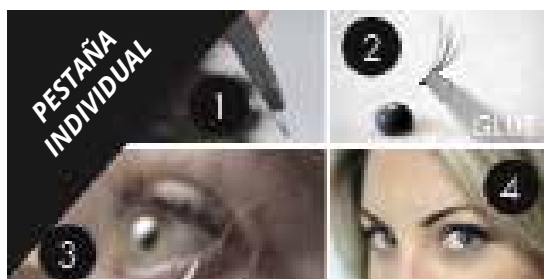

#### Einzelne Wimper Ciglia individuali

1. Wimper mit einer Pinzette aufnehmen
2. Die Basis mit Kleber befeuchten
3. Auf den Haaransatz der Wimpern anbringen. Niemals auf das Augenlid
4. Schminken und fertig!

1. Prendi le ciglia con una pinzetta
2. Bagna la base con l'adesivo
3. Posiziona sulla linea delle ciglia. Mai sulla palpebra
4. Trucca e voilà!

**Für einen natürlichen  
und interessanten Look**  
*Per un look naturale e sofisticato*



### Magnetische Wimpern Andrea Ciglia magnetiche Andrea

1  
u.m.vta

72  
box

- » Leicht aufzutragen, ohne Notwendigkeit eines Klebers, wiederverwendbar
- » Mehrfachmagnet-Technologie, damit die Wimpern problemlos auf Ihrer natürlichen Wimpernlinie anhaften
- » Vorgebogener Konturstreifen zur Anpassung an das Augenlid
- » Die Wimpern sitzen gut, bis Sie beschließen, sie zu entfernen
- » Bestehend aus einer oberen und einer unteren Wimper, um den einschlagenden Effekt eines doppelten Volumens zu erzielen
- » Sie benötigen keinen Kleber und sind wiederverwendbar

- » *Facili da applicare, non hanno bisogno di adesivo. Riutilizzabili*
- » *Tecnologia a più magneti per far sì che le ciglia aderiscano perfettamente alla tua linea naturale*
- » *Striscia precurvata sagomata per adattarsi alla palpebra*
- » *Le ciglia rimangono ben salde finché non decidi di rimuoverle*
- » *Composte da un ciglio superiore e uno inferiore per un sorprendente effetto doppio volume*
- » *Non hanno bisogno di adesivo e sono riutilizzabili*

- » Doppelt 21
- » Doppie 21

REF.06445

- » Doppelt 45
- » Doppie 45

REF.06446



### Pinzette für falsche Wimpern Pinzette per ciglia finte

1  
u.m.vta

12  
box

Pinzette zur Anbringung von falschen Wimpern, hilft beim Auftragen der kompletten Wimpern mit mehr Präzision und Hygiene

*Pinzette per posizionare le ciglia finte, aiuta a posizionare le ciglia complete con maggiore precisione e igiene*



REF.06314

**Wimpern ANDREA SM**  
**Ciglia ANDREA SM**4  
u.m.vta72  
box» 62 Schwarz  
» 62 Nere

REF.02700

» 70 Schwarz  
» 70 Nere

REF.02701

» 21 Schwarz  
» 21 Nere

REF.02690

» 21 braun  
» 21 Marroni

REF.02691

» 23 Schwarz  
» 23 Nere

REF.02692

» 26 Schwarz  
» 26 Nere

REF.02693

» 28 Schwarz  
» 28 Nere

REF.02694

» 33 Schwarz  
» 33 Nere

REF.02695

» 45 Schwarz  
» 45 Nere

REF.02696

» 45 braun  
» 45 Marroni

REF.02697

» 53 Schwarz  
» 53 Nere

REF.02698

» 53 braun  
» 53 Marroni

REF.02699

**Komplette Wimpern selbstklebend schwarz**  
*Ciglia intere autoadesive nere*

4 u.m.vta  
72 box

» 33 Schwarz  
» 33 Nere



REF.03670

» 21 Schwarz  
» 21 Nere



REF.03672

» 45 Schwarz  
» 45 Nere



REF.03673

» 53 Schwarz  
» 53 Nere



REF.03671

**Komplette Wimpern**  
*Full eyelashes*

4 u.m.vta  
72 box

» 52 Schwarz  
» 52 Nere



REF.04841

» 33 braun  
» 33 Marroni



REF.04079

» 80 Schwarz  
» 80 Nere



REF.04842

» 82 Schwarz  
» 82 Nere



REF.04843

» 19 Schwarz  
» 19 Nere



REF.04844

» Mod. Accents  
» 318 Schwarz  
» Mod. Accents  
» 318 nere



REF.04846

» Mod. Accents  
» 301 Schwarz

» Mod. Accents  
» 301 nere



REF.04554

» Mod. Accents  
» 305 Schwarz

» Mod. Accents  
» 305 nere



REF.04555

### Komplette Wimpern Lashlites 335 schwarz

Ciglia intere Lashlites 335 nere

4  
u.m.vta

72  
box



REF.04845

### Kit Wimpern Andrea Starter

Kit ciglia Andrea Starter

4  
u.m.vta

36  
box

- » Starter 45
- » Starter 45



REF.02704

### Strähne Wimpern ohne Knoten

Ciuffi di ciglia senza nodi

4  
u.m.vta

72  
box

- » Lang
- » Lunghie



REF.04553

- » Starter 53
- » Starter 53



REF.02703

- » Mittellang
- » Medie



REF.04552

- » Starter 33
- » Starter 33



REF.02702

- » Kurz
- » Corte



REF.04551

Vorher. Prima

Nachher. Dopo



**Kit Einzelne Wimpern Permalash**  
Ciglia individuali Permalash, ciuffi

4  
u.m.vta

72  
box

» Mittellang  
» Braun SM

» Medie  
» Marroni SM



REF.02708

» Combo  
» Schwarz

» Combo  
» Nere



REF.03278

» Mittellang  
» Schwarz SM

» Medie  
» Nere SM



REF.02707

» Lang  
» Schwarz

» Lunghe  
» Nere



REF.04078

» Klein  
» Schwarz SM

» Piccol2  
» Nere SM



REF.02705

» Klein, Braun  
SM

» Piccole,  
» Marroni SM



REF.02706

» Mittellang,  
Haar für Haar,  
schwarz

» Medie nere,  
peli singoli



REF.03277

» Kurz, Haar  
für Haar,  
schwarz

» Corte nere,  
peli singoli



REF.03276

**Kit Einzelne Wimpern Combo schwarz**  
Kit ciglia singole combo nere

4  
u.m.vta

36  
box



REF.04077

### Verkaufsträger Wimpern Andrea Espositore per ciglia Andrea

1 u.m.vta 1 box



Drehbarer Verkaufsträger  
Espositore rotante

REF.03203

Enthält je 8 Stück:

- » Komplette Wimpern: 02690, 02691, 02693, 02695, 92696, 02698, 02700, 02701
- » Kleber für komplette Wimpern: 02711 (hell), 02712 (dunkel)
- » Einzelne Wimpern: 02705, 02706, 2707, 02708, 03278
- » Kleber für einzelne Wimpern: 02713 (hell), 03066 (dunkel)
- » Lösungsmittel für Kleber für einzelne Wimpern: 03204

- » Contiene 8 unità di ciascuna:
- » Ciglia intere: 02690, 02691, 02693, 02695, 92696, 02698, 02700, 02701
- » Adesivo per ciglia intere: 02711 (chiaro), 02712 (scuro)
- » Ciglia individuali: 02705, 02706, 2707, 02708, 03278
- » Adesivo per ciglia individuali: 02713 (chiaro), 03066 (scuro)
- » Solvente per ciglia adesive singole: 03204



### Kleber für einzelne Wimpern Adesivo per ciglia individuali

6 u.m.vta 72 box

» Andrea  
Permalash **hell**  
transparent



3,5 gr

REF.02713

» Andrea  
Permalash  
**Chiaro**  
trasparente

» Andrea  
Permalash  
**dunkel**



3,5 gr

REF.03066

» Andrea  
Permalash  
**Scuro**

### Lösungsmittel für Kleber für EINZELNE Wimpern Solvente per ciglia adesive SINGOLE

6 u.m.vta 72 box



7 gr

REF.03204

1 u.m.vta 1 box

18 Codes x 4 Blister  
18 codici x 4 blister

REF.04200

### Kleber für KOMPLETTE Wimpern Adesivo per ciglia INTERE

6 u.m.vta 72 box

» Andrea  
Permalash **hell**  
transparent



7 gr

REF.02711

» Andrea  
Permalash  
**Chiaro**  
trasparente

» Andrea  
Permalash  
**dunkel**



7 gr

REF.02712

» Andrea  
Permalash  
**Scuro**

1 u.m.vta 1 box

Verkaufsträger für  
Wimpern Andrea LEER

Espositore per ciglia  
Andrea VUOTO

REF.03335





**Wimpern-Curler**  
**Piegaciglia**12  
u.m.vta12  
box

REF.01109

**Ersatzgummi Wimpern-Curler**  
**Ricambio in gomma per piegaciglia**12  
u.m.vta12  
box

2 u

REF.01110

**3 Rasiermesser pollié für augenbrauen**  
**3 Rasoi pollié per sopracciglia**1  
u.m.vta12  
box

Rasierklinge für Augenbrauen, Gesichts- und Körperbehaarung. Für einen sanfteren und komfortableren Schnitt raten wir, das Gel oder die Creme in dem Bereich aufzutragen, den man rasieren möchte. Der Griff ist aus ABS hergestellt, während die Klinge aus hochwertigem Edelstahl ist.

*Rasoio per sopracciglia, peli del viso e del corpo. Si consiglia di applicare gel o crema nella zona da rasare, in modo che il taglio sia più morbido e confortevole. Il manico è in ABS mentre la lametta è in acciaio inossidabile di alta qualità.*

NEW

REF.07125



13 cm



NEW

REF.07126



15 cm



## Augenbrauen Andrea Sopracciglia Andrea

1  
u.m.vta

24  
box

- » 3 in 1 Creme mittelbraun
- » 3 in 1 crema marrone medio



REF.06286

- » 3 in 1 Creme dunkelbraun
- » 3 in 1 crema marrone scuro



REF.06285

- » Pulver Duo mittelbraun
- » Cipria duo marrone medio



REF.06287

- » Pulver Duo dunkelbraun
- » Cipria duo marrone scuro



REF.06288

- » Stift Duo mittelbraun
- » Pencil duo marrone medio



REF.06290

- » Stift Duo dunkelbraun
- » Pencil duo marrone scuro



REF.06289

## Pack 3 Rasierklingen Augenbrauen Confezione da 3 lamette per sopracciglia



REF.06291

## Fixiergel transparent Gel fissante trasparente

1  
u.m.vta

24  
box



REF.06292

07

# Accessoires und hygiene

ACCESSORI  
E IGIENE

*Abdeckungen und Papier für Kosmetikstühle, Handtücher, Laken, Spiegel, Kleidung, Koffer...*

*Fodere e carta coprilettino, asciugamani, lenzuola, specchi, guardaroba, valigie...*



### Tasche 10 Verstellbare Abdeckung Kosmetikstuhl Confezione da 10 fodere adattabili per lettino



REF.07308

30 gr

- » Material: Vliesstoff
- » Abmessungen: 210 cm x 80 cm
- » Box 100 Stück Abdeckungen für Kosmetikstuhl, an den Enden verstellbar
- » In individuelm Beutel geliefert
- » Gewicht: 40 g

- » Materiale: Tessuto non tessuto
- » Dimensioni: 210 cm x 80 cm
- » Scatola da 100 unità copri lettino regolabili alle estremità
- » Presentato in sacchetto individuale
- » Peso: 40 g



### Rolle Papier für Kosmetikstuhl Rotolo di carta coprilettino



REF. 00928

43 gr

- » Länge: 78 m / Breite: 59 cm
- » Papiergewicht: 43 g
- » 40 markierte und vorgeschnittene Teile von je 1,95 m Länge
- » Die Rollen sind einzeln verpackt

- » Lunghezza: 78 m / larghezza: 59 cm
- » Grammatatura carta: 43 g
- » 40 servizi segnati e pretagliati, ciascuno lungo 1,95 m
- » I rotoli sono confezionati singolarmente



REF.00928/75

### Rolle Papier für Kosmetikstuhl superbreit Rotolo di carta lettino extra larga



REF. 03336

43 gr

- » Super Breite: 78 cm
- » 40 markierte und vorgeschnittene Teile von je 1,95 m Länge
- » Die Rollen sind einzeln verpackt

- » Extra larga: 78 cm
- » 40 servizi segnati e pretagliati, ciascuno lungo 1,95 m
- » I rotoli sono confezionati singolarmente



### Heizdecke für Kosmetikstühle Coperta elettrica per lettini

1 u.m.vta 4 box

90 gr

REF. 06273

- » Leistung: 60 W
- » 3 Temperaturniveaus
- » Temperaturanzeige durch LEDs
- » Fühlt sich weich und komfortabel an
- » Waschbar
- » Maße: 150 x 60 cm
- » Spannung: 230V ~
- » Frequenz: 50/60 Hz

- » Potenza: 60 W.
- » 3 livelli di temperatura
- » Indicatore di temperatura a LED
- » Coperta morbida e confortevole al tatto
- » Lavabile
- » Misure: 150 x 60 cm
- » Voltaggio: 230V ~
- » Frequenza: 50/60 Hz

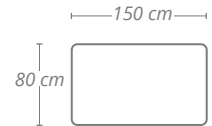

### 30 Einweglaken 30 lenzuola antisudore

1 u.m.vta 10 box

REF. 03912

### Abdeckung Kosmetikstuhl Tergal weiß Fodera coprilettino tergal bianco

1 u.m.vta 12 box

REF. 06650

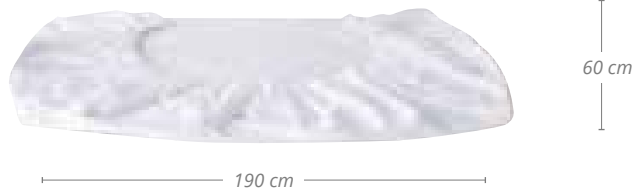
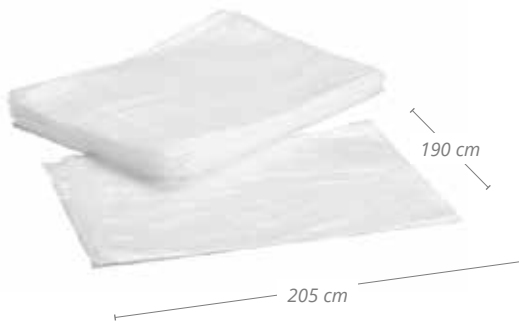

### Abdeckungen Kosmetikstuhl plastifiziert Fodera coprilettino plastificata

1 u.m.vta 100 box

REF. 03695

- » Abdeckung für Kosmetikstuhl plastifiziert, für Behandlungen
- » Verstellbar
- » Einzeln verpackt

- » Fodera coprilettino plastificata per trattamenti
- » Regolabile
- » Confezionate singolarmente

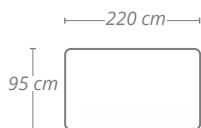

### Beutel 20 Abdeckungen Kosmetikstuhl Confezione da 20 fodere coprilettino

1 u.m.vta 22 box

REF. 03248

- » Nicht verstellbar. Typ Laken
- » Non regolabile. Tipo lenzuola

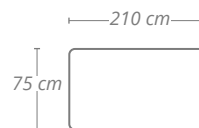

### Beutel mit 75 Handtüchern ZELLULOSE

#### Confezione da 75 salviette CELLULOSA

- » Spezial Maniküre
- » Speciale per manicure

50 gr/m<sup>2</sup>

REF. 04204

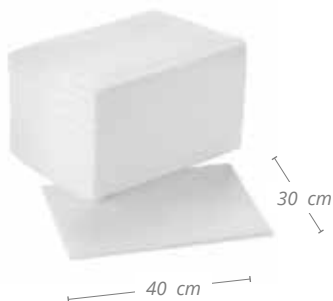

### Beutel mit 25 Handtüchern SPUNLACE

#### Confezione da 25 salviette SPUNLACE

- » Gefaltet auf 20 x 20 cm
- » 50% Polyester / 50% Viskose



- » Piegare 20 x 20 cm
- » 50% poliestere / 50% viscosa

24 box

50 gr/m<sup>2</sup>

40 x 90 cm

REF. 04916

28 box

50 gr/m<sup>2</sup>

40 x 80 cm

REF. 03221



### Beutel mit 90 Handtüchern ZELLULOSE

#### Confezione da 90 salviette CELLULOSA

55 gr/m<sup>2</sup>

REF.04076

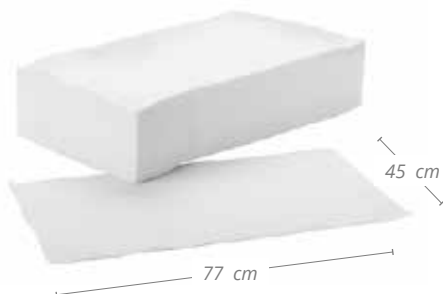

### Beutel mit 100 Handtüchern SPUNLACE

#### Confezione da 100 salviette SPUNLACE

- » Super-absorbierend
- » Ultra assorbenti



REF. 03283



### Beutel 200 Handtücher ZELLULOSE

#### Confezione da 200 salviette CELLULOSA

50 gr/m<sup>2</sup>

REF.06664

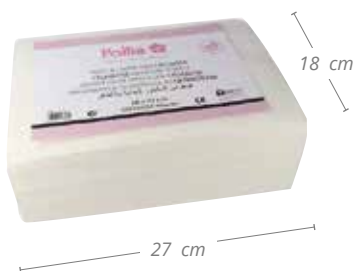

### 35 Handtücher SPUNLACE

#### Confezione da 35 asciugamani SPUNLACE

- » Handtücher gefaltet
- » Spezial für Maniküre

50 gr/m<sup>2</sup>

REF. 04509

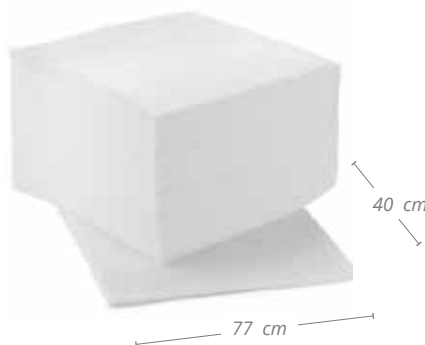

### Beutel 100 Handtücher SPUNLACE Confezione da 100 salviette SPUNLACE

- » Handtücher gefaltet
- » Spezial für Maniküre

- » Salviette piegate
- » Speciale per manicure

NEW

1  
u.m.vta16  
box

REF. 07302

- » Handtücher gefaltet
- » Spezial für Maniküre

- » Salviette piegate
- » Speciale per manicure

NEW

1  
u.m.vta32  
box

REF. 07303

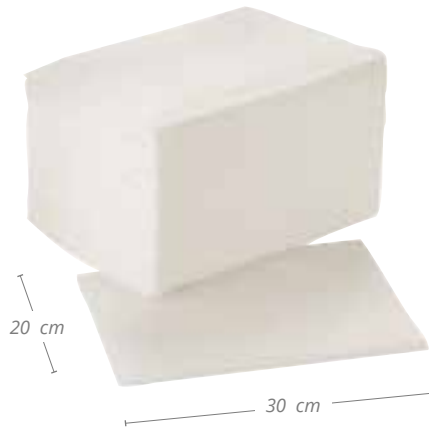
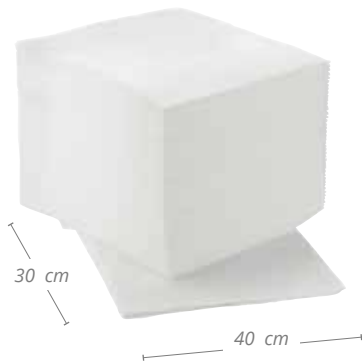

### Beutel 75 Handtücher SPUNLACE Confezione da 75 salviette SPUNLACE

- » Super-absorbierend
- » Handtücher gefaltet
- » Spezial für Maniküre

- » Ultra assorbenti
- » Salviette piegate
- » Speciale per manicure

1  
u.m.vta16  
box

REF. 04510

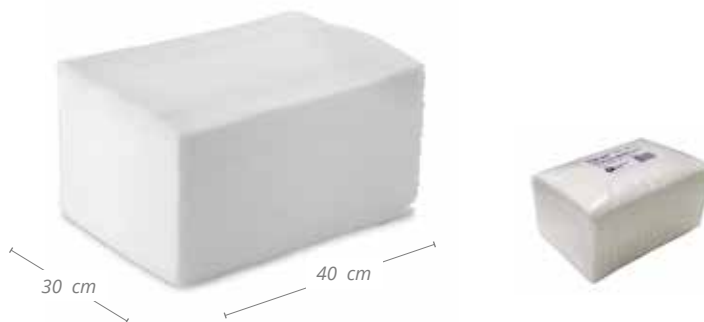

### Schutzhose Protezioni - pantaloni

Schutzhose aus Polyethylen von hoher Dichte für Schönheitsbehandlungen wie Pressotherapie oder Behandlungen in der Kabine mit Algen oder Fango. Beutel mit 25 Stück.

*Pantalone protettivo in polietilene ad alta densità per trattamenti estetici come pressoterapia o trattamenti in cabina con alghe o fanghi. Confezione da 25 unità.*

1  
u.m.vta10  
box

REF. 06111



### 100 transparente Polyethylenhandschuhe 100 Guanti polietilene trasparenti



- » 100% jungfräuliches Polyethylen hdpe 0,7 +/- 2% g / Stk
- » Hypoallergen, wasserdicht, Einheitsgröße
- » PSA Kategorie 1
- » Hergestellt und CE-gekennzeichnet, kompatibel mit Lebensmitteln 2011/10 / CE
- » 30 cm. Höhe x 25 cm. Fingerbreite x 15 cm. Handgelenkbreite

- » Polietilene hdpe 100% 0,7 +/- 2% g / pz
- » Anallergici, impermeabile, taglia unica,
- » DPI di categoria 1, prodotti e marcati CE,
- » Compatibile con uso alimentare 2011/10 / CE
- » 30 Cm altezza x 25 cm larghezza x 15 larghezza polso 15



NEW

REF. 07804



### Beutel mit 100 Einweghandschuhen Confezione da 100 guanti monouso



REF. 07304



NEW



### 100 Handschuhe einmaligen Gebrauch 100 Guanti monouso



REF. 07257

- » Mit beidhändig kann jeder Handschuh für jede Hand verwendet werden
- » Einheitsgröße
- » Mehrzweck

- » Ambidestro consente a ciascun guanto di essere usato per qualsiasi mano
- » Taglia unica
- » Multiuso



NEW



### Beutel 2 Stück professionelle Handschuhe Confezione da 2 unità guanti professionali



- » Material: Kautschuk
- » Materiale: gomma

6,5  
Talla / Size

REF.01672

7  
Talle / Size

REF.01673

7,5  
Talla / Size

REF.01674

8  
Talle / Size

REF.01675



### Karton 50 synthetische Handschuhe

#### Confezione da 50 guanti sintetici



**Ohne Pulver**  
SENZA polvere

- » Verbindet die Flexibilität von Latex und die Elastizität des geruchslosen Vinyls.
- » Gefühl einer zweiten Haut, dank ihrer elastischen Eigenschaften, sehr ähnlich wie beim Latex, und bietet die hypoallergenen Eigenschaften des Vinyls.
- » Material: PVC-Derivat.
- » Nicht steril
- » Farbe schwarz
- » Innen- und Außenoberfläche glatt
- » Geeignet für Latex-Allergiker

- » *Combinano la flessibilità del lattice e l'elasticità del vinile inodore.*
- » *Sensazione di seconda pelle grazie alle sue proprietà elastiche molto simili al lattice e alle proprietà ipoallergeniche del vinile.*
- » *Materiale: derivato del PVC*
- » *Non sterili*
- » *Colore nero*
- » *Superfici interne ed esterne lisce.*
- » *Adatti agli allergici al lattice.*

NEW

M

REF. 07263



L

REF. 07264

### Schachtel mit 100 weißen Latexhandschuhen mit wenig Puder

#### Confezione da 100 guanti in latex bianco con poco talco

LATEX / LATEX  
AQL 1,5

S/M

REF. 01671

S/M

REF. 01669

S/M

REF. 01670

### Schachtel mit 20 schwarzen Latexhandschuhen

#### Confezione da 20 guanti in latex

LATEX / LATEX  
AQL 1,5

**Ohne Pulver**  
SENZA polvere



S

REF. 02832

M

REF. 02833

L

REF. 02834

### Schachtel mit 100 Vinyl-Handschuhen

#### Confezione da 100 guanti in vinile

VINYL / VINILE  
AQL 1,5

**Ohne Pulver**  
SENZA polvere



S

REF. 02586

M

REF. 02587

L

REF. 02588

**Pinzette rostfrei doppelt, allgemeine Verwendung für Utensilien**  
**Pinzette in acciaio inossidabile. Per uso generale**

1 u.m.vta  
12 box

REF.04556



**Handtuch 100% Baumwolle**  
**Asciugamano 100% cotone**

12 u.m.vta  
48 box

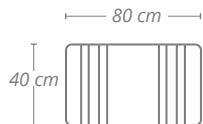

380 gr

REF. 02947/58

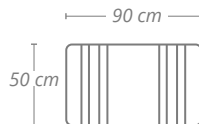

380 gr

REF. 02901/58



**Handtuch Maniküre**  
**Asciugamano per manicure**

12 u.m.vta  
12 box

REF.00974

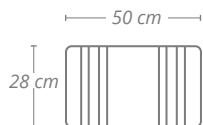

**Handtuch 100% Baumwolle**  
**Asciugamano 100% cotone**

1 u.m.vta  
24 box

**TASSEL**  
LINEA CANTIERE

1 u.m.vta  
48 box

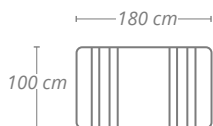

300 gr

REF. 06570/58

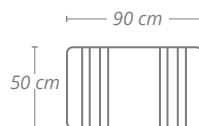

300 gr

REF. 06571/58



**Mehrzweck-Bürste, farbig**  
**Spazzola colorata multiuso**

24 u.m.vta  
24 box

REF. 00129



**Bürste für Kleidung und Polstermöbel**  
**Spazzola per abiti e tappezzeria**

1 u.m.vta  
20 box

REF.00893

» Gummi blau  
 » Gomma blu



## Schutzlaken

### Lenzuola protettiva



REF. 06112

REF. 06110



Laken aus Polyethylen von hoher Dichte. 25 Stück von 180 x 200 cm. Für Behandlungen mit Algen und Fango

Laken aus Polyethylen von hoher Dichte. 50 Stück von 180 x 200 cm. Für Behandlungen mit Algen und Fango

Lenzuola in polietilene ad alta densità. 25 unità da 180 x 200 cm. Per trattamenti con alghe e fanghi

Lenzuola in polietilene ad alta densità. 50 unità da 180 x 200 cm. Per trattamenti con alghe e fanghi

## Spa-Waage, misst die Hydratation und den Anteil an Körperfett

### La bilancia spa misura l'idratazione e la percentuale di massa grassa



REF. 04805

- » Fassungsvermögen: 150 kg
- » Skala: 6 bis 150 kg
- » Gewichtseinheiten: kg / lb / st
- » Zwei Batterien CR2032 (mitgeliefert)
- » Wiegeschwindigkeit: mittlere Geschwindigkeit etwa zwei Sekunden
- » Automatische Abschaltung: 10 Sekunden
- » Wenn der Batteriestand niedrig ist, erscheint am Bildschirm "LO"

- » Capacità: 150 kg
- » Scala: Da 6 a 150 kg
- » Unità di peso: kg / lb / st
- » Due batterie CR2032 (incluse)
- » Velocità di pesatura: velocità media (circa due secondi)
- » Spegnimento automatico: 10 secondi
- » Quando la batteria è scarica, sullo schermo verrà visualizzato "LO".



## Fußmatten Solarium

### Tappetini per solarium



REF.03803

- » Beutel 50 Fußmatten für Solarium
- » Confezione da 50 tappetini per solarium



Ø 35 cm

### Einweg-Kimono Kimono monouso

- » Maße: 104 x 140 cm
- » Material: Vliesstoff (ungeflochtenes Gewebe)
- » Der Gürtel befindet sich in einer Tasche des linken Arms

- » Misure: 104 x 140 cm
- » Materiale: tessuto non tessuto
- » La cintura si trova in una tasca del braccio sinistro



NEW

35 gr

REF. 07307/58



NEW

35 gr

REF. 07307/50

### Beutel 100 schuh-überzüge Fodera copriscarpe da 100 unità

- » Einweg
- » Plastik
- » Monouso
- » Plastico



REF. 07211



NEW



**Beutel mit 100 Schuhen mit Gummisohle**  
**Confezione da 100 ciabattine con suola in gomma**

100  
u.m.vta

100  
box

» Offen  
 » Aperte



REF.02919

» Geschlossen  
 » Chiuse



REF.02920

**Beutel mit 50 Schuhen mit Gummisohle**  
**Confezione da 50 ciabattine con suola in gomma**

1  
u.m.vta

10  
box

» Offen  
 » Einmaliger Gebrauch

» Aperte  
 » Monouso



REF.03807

» Geschlossen  
 » Einmaliger Gebrauch

» Chiuse  
 » Monouso



REF.03808

**Tasche mit 12 Paar gepolsterten Turnschuhen**  
**Confezione da 12 paia di ciabattine imbottite**

1  
u.m.vta

16  
box



REF. 06661

**Paar zwei Pediküre-Hausschuhe**  
**Paio di due ciabatte da pedicure**

» Verschiedene  
 Farben  
 » Assortimento di colori

1  
u.m.vta

12  
box



REF. 06776

**Tasche mit 12 Paar Pediküre-Hausschuhe**  
**Confezione da 12 paia di ciabatte da pedicure**

1  
u.m.vta

480  
box



NEW

REF. 07432

### Beutel 100 Hauben Confezione da 100 cuffie



- » Einmaliger Gebrauch
- » Gefaltet nach Art eines Akkordeons

14 gr/m<sup>2</sup>

REF.07305

- » Monouso
- » Piegata a fisarmonica

### Box 100 Diademe weiß Confezione da 100 fascette bianche



- » Einmaliger Gebrauch
- » Monouso

REF.07306



### Rolle Krepp-Papier Rotolo di carta crepe



- » Für Diademe
- » 100 Teile
- » Spezial Schönheitspflege
- » Farbe rosa

REF.04420

- » Per fasce
- » 100 servizi
- » Speciale estetica
- » Colore rosa



### Box 50 Tangas Herren

Confezione da 50 tanga da uomo



REF.03216

- » Einmaliger Gebrauch
- » Einheitliche Größe
- » Gummi zur Anpassung an alle Maße
- » Farbe mattschwarz
- » Ideal als Ergänzung zur Haarentfernung und Haarbehandlung

- » Monouso
- » Taglia unica
- » Elastico per adattarsi a qualsiasi taglia
- » Colore nero opaco
- » Ideale come complemento per depilazione e trattamenti



### Box 50 Slips Herren

Confezione da 50 slip da uomo



REF.03295

- » Einmaliger Gebrauch
- » Einheitliche Größe
- » Elastische zur Anpassung an jedes Maß
- » Farbe mattblau
- » Ideal als Ergänzung zur Haarentfernung und Behandlung

- » Monouso
- » Taglia unica
- » Elastico per adattarsi a qualsiasi taglia
- » Colore blu opaco
- » Ideale come complemento per depilazione e trattamenti



### Beutel 100 Tangas Typ Steinschleuder Damen

Confezione da 100 tanga da donna



REF.03483

- » Gummi zur Anpassung an alle Maße
- » Einmaliger Gebrauch

- » Elastico per adattarsi a qualsiasi taglia
- » Monouso



### Beutel 10 Boxershorts Herren

Confezione da 10 boxer da uomo

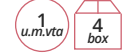

REF.03802

- » Einmaliger Gebrauch
- » Monouso



### Beutel 100 String-Tangas Damen

Confezione da 100 tanga da donna in tessuto



REF.01091

- » Sehr enges hinteres Band
- » Einmaliger Gebrauch

- » Filo posteriore molto fine
- » Monouso



### Hose Pressotherapie Kunststoff

Pantaloni per pressoterapia in plastica



REF.03694

- » Ohne Gummi
- » Farbe weiß
- » Einmaliger Gebrauch

- » Senza elastico
- » Colore bianco
- » Monouso



## Diadem Schönheitspflege Fascia per estetista

10  
u.m.vta

100  
box

REF. 01088



## T-Shirt TASSEL Maglietta TASSEL

1  
u.m.vta

50  
box

Damen-T-Shirts aus Baumwolle. Farbe schwarz, Rundkragen und kurze Ärmel mit dem Logo Tassel als Siebdruck auf der Brust. Verfügbar in mehreren Größen. Bequem, leicht zu kombinieren mit jedem Look. Widerstandsfähiges Gewebe.

Magliette da donna in cotone. Colore nero, girocollo e maniche corte con logo Tassel serigrafato sul petto. Disponibili in varie misure. Comode, facili da abbinare a qualsiasi look. Tessuto resistente.



M

REF.06284/2

L

REF.06284/3

XL

REF.06284/4

XXL

REF.06284/5

## Anti-fog-schutzbrille Occhiali protettivi antivapore

1  
u.m.vta

10  
box

REF.07256

- » Schutz zur Prävention gegen Infektionen: schützt wirksam gegen Spritzer, Kies usw.
- » Verwendungsort: jeder Ort, an dem Augenschutz erforderlich ist.
- » Innovatives, komfortables Design. Passt sich perfekt an jede Kopfform und Kopfgröße an.
- » Kann gleichzeitig mit Ihrer normalen Brille verwendet werden.
- » EG-Zertifizierung
- » Material: Kunststoff

- » Protezione per prevenire le infezioni: proteggere efficacemente da schizzi, schegge, ecc.
- » Luogo di utilizzo: qualsiasi luogo in cui è richiesta la protezione degli occhi.
- » Confortevole design innovativo. Si adattano perfettamente a qualsiasi forma e dimensione della testa.
- » Possono essere utilizzati contemporaneamente agli occhiali da vista.
- » Certificato CE.
- » Materiale: plastica

NEW



## Desinfizierende fussmatte Tappetino disinfettante per calzature

1  
u.m.vta

12  
box

REF.07234

Extra flache Fußmatte mit nur 1 cm Höhe zur Verhinderung von Ausrutschen, hergestellt aus Polypropylen auf einer Gummiunterlage, enthält ionisiertes Aluminium. Maße: 60 cm Breite x 40 cm Länge x 1 cm Höhe/Dicke.

Verwendung: die Matte auf eine ebene, waagerechte Fläche legen, etwa 700 ml Desinfektionsflüssigkeit auf die Ablage auftragen. Es ist ratsam, einen Fußbretter auf die Ablage zu legen, um die Schuhe des Kunden zu trocknen.

Tappetino extra piatto alto solo 1 cm per evitare inciampi, realizzato in polipropilene su base in gomma e contenitore in alluminio ionizzato. Misure: 60 cm di larghezza x 40 cm di lunghezza x 1 cm di altezza/spessore.

Modo d'uso: posizionare il tappetino su una superficie piana e livellata, applicare circa 700ml di liquido disinfettante sul vassoio. Si consiglia di posizionare un tappetino accanto al vassoio per asciugare le scarpe del cliente.

NEW

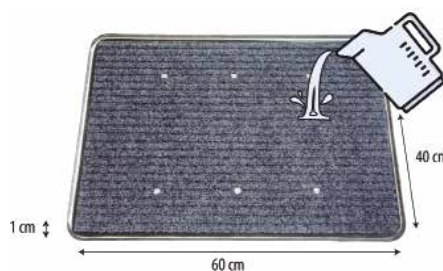



### Beutel mit 1 kg Baumwolle in Rollen Confezione da 1 kg di cotone in rotoli

Spitzen inbegriffen  
Fermagli inclusi



REF. 00964



Anonym  
Senza marca  
REF. 00964/00

» 4 Schnitte von 8 cm  
» 4 tagli da 8 cm



REF. 04290

» Gefaltet  
» Piegato

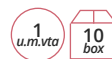

REF. 04288



### Beutel Abschminkscheiben Sacchetto dischi struccanti

» 80 Scheiben  
» 80 dischi



REF. 07118

» Anonym  
» Senza marca



REF. 07118/00



### Box 200 wattestäbchen mit PAPIERSCHAFT Confezione da 200 cotton fioc con BASTONCINO DI CARTA

NEW



REF.07261



### Beutel Watte „zick-zack“, vorgeschnitten Sacchetto cotone zigzag pretagliato



REF.02949



### Runder Spiegel, verchromt

### Specchio tondo cromato



Ø 10

1 u.m.vta  
60 box

5x

REF.06716

1 u.m.vta  
60 box

7x

REF.06717

1 u.m.vta  
60 box

10x

REF.06718

Ø 15

1 u.m.vta  
24 box

5x

REF.06719

1 u.m.vta  
24 box

7x

REF.06720

1 u.m.vta  
24 box

10x

REF.06721

Ø 18

1 u.m.vta  
24 box

5x

REF.06722

1 u.m.vta  
24 box

7x

REF.06723

1 u.m.vta  
24 box

10x

REF.06724

### Runder Spiegel, verchromt mit 3 Saugnäpfen

### Specchio tondo cromato con 3 ventose



Ø 15

1 u.m.vta  
48 box

5x

REF.06725

1 u.m.vta  
48 box

7x

REF.06726

1 u.m.vta  
24 box

10x

REF.06727

Ø 21

1 u.m.vta  
24 box

5x

REF.06728

1 u.m.vta  
24 box

7x

REF.06729

1 u.m.vta  
24 box

10x

REF.06730

**Runder Spiegel, verchromt mit Basis**  
**Specchio tondo cromato con base**



Ø 15



7x

REF.06731

Ø 15



10x

REF.06732

Ø 21



7x

REF.06735

Ø 21



10x

REF.06736



Ø 15



7x

REF.06733

Ø 15



10x

REF.06734

Ø 21



7x

REF.06737

Ø 21



10x

REF.06738

**Runder Spiegel, verchromt mit Fuß und Basis**  
**Specchio tondo cromato con asta e base**



Ø 15



7x

REF.06739

Ø 15



10x

REF.06740

Ø 21



7x

REF.06741

Ø 21



10x

REF.06742

**Spiegel mit doppeltem Metallfuß 5 Vergrößerung / normal**  
**Specchio con piede in metallo 5x / normale**

16,5 cm

1 u.m.vta  
6 box

5x

REF.02801

19 cm

1 u.m.vta  
6 box

5x

REF.02806

16,5 cm

1 u.m.vta  
12 box

5x

REF.02799

19 cm

1 u.m.vta  
12 box

5x

REF.02800

**Doppelspiegel**  
**Specchio doppio**

- » Griff und Ständer
- » Manico e supporto

1 u.m.vta  
24 box

REF. 01965



**Runder Spiegel**  
**Specchio tondo**

- » Professionell
- » Professionale

1 u.m.vta  
8 box

REF. 00294/56

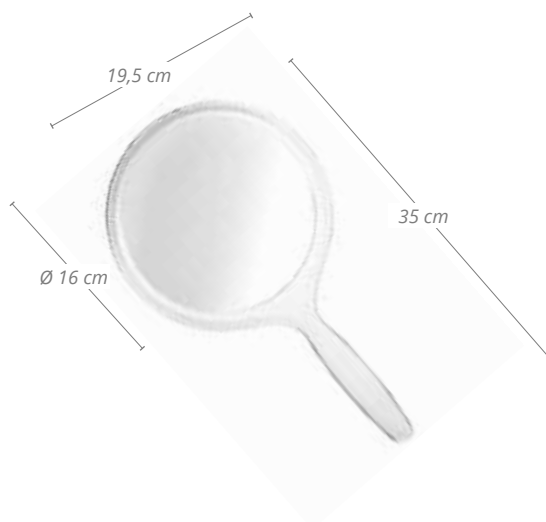

## Spiegel Specchi

- » Handtaschenspiegel Modell Capilla
- » Specchio da borsa richiudibile



REF. 00265

7 cm



7 cm

- » Runder Spiegel
- » Normal/Vergrößerung
- » Specchio tondo
- » Normale/Aumento



REF. 00266

8,5 cm



8,5 cm

- » Spiegel Puderdose
- » Normal/Vergrößerung
- » Mit Kamm



REF. 03073

- » Specchio compatto
- » Normale/Ingranditore
- » Con pettine

7,5 cm



7,5 cm

## Handtaschenspiegel quadratisch Specchio da borsa quadrato



S

REF. 00270



7 cm

6 cm



L

REF. 00268



11 cm

9,5 cm

## Spiegel Puderdose normal/Vergrößerung Specchio compatto normale/ingranditore



S

REF. 00214



14,6 cm

9 cm



L

REF. 00213



19 cm

9 cm

### Runder Spiegel Specchio tondo

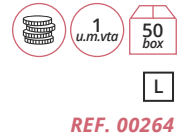

### Spiegel Specchi

- » Quadratisch mit Griff
- » Quadrato con manico



- » Schaum EVA
- » Schwarz

- » Gomma EVA
- » Nero



### Runder Spiegel Specchio tondo



### Campingspiegel Specchio da campeggio

12  
u.m.vta

12  
box

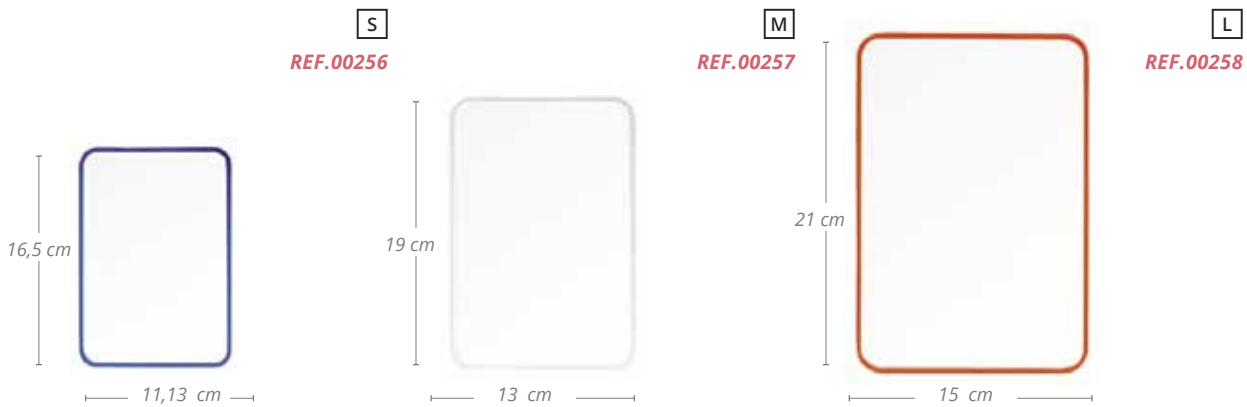

### Campingspiegel Specchio da campeggio

1  
u.m.vta

12  
box



### Fernsehspiegel Specchio TV

1  
u.m.vta

10  
box

REF. 00254/50

REF. 00254/58

REF. 00255



## Schachtel mit 50 hygienischen Gesichtsmasken

### Confezione da 50 maschere facciali igieniche



REF. 07383

NEW



## Hygienemaske 100% BAUMWOLLE 30 mal wiederverwendbar /waschbar

### Maschera igienica 100% COTONE 30 usi riutilizzabile /lavabile



REF. 07803

» 30 mal verwendbar  
 » WASCHBAR: Bei 60° waschen, trocknen und 10-15 Sekunden lang bei 140° bügeln, um die Behandlung zu aktivieren. (30 Waschvorgänge)

» 30 servizi  
 » LAVABILE: Lavare a 60°, asciugare e stirare a 140° per 10-15 secondi per attivare il trattamento. (N. lavaggi 30)

NEW



## Gesichtsschutzschirm

### Schermo protettivo per il viso



REF. 07212

ANTI-FOG  
 Transparenter Kunststoff mit Schaumstoff auf der Vorderseite für mehr Komfort

ANTI-APPANNAMENTO  
 Plastica trasparente con gommapiuma sulla fronte per un maggior comfort

NEW

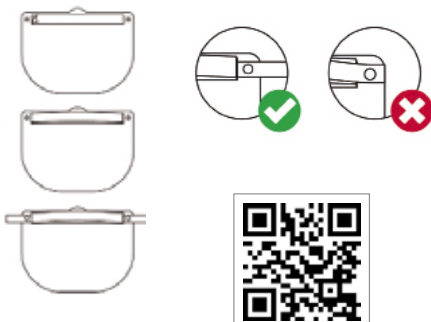



**NEW**

**Wiederverwendbare maske,  
60 waschvorgänge**  
*Mascherina riutilizzabile  
60 lavaggi*

- » Wiederverwendbar
- » Zertifiziert
- » Waterproof
- » Schwitzfähig
- » Mikrofaser
- » Entspricht FFP-2
- » LACLA Made in Spain

- » Riutilizzabili
- » Certificate
- » Waterproof
- » Traspiranti
- » Microfibra
- » Equivalenza FFP-2
- » LACLA Made in Spain

**Packs 6 stoffmasken einheiten einfarbig**  
*Confezioni 6 mascherine tinta unita*



Schwarz  
*Nero*

**REF. 07309**

Rosa  
*Rosa*

**REF. 07310**

Beige  
*Beige*

**REF. 07318**

Weiss  
*Bianco*

**REF. 07319**



**Packs 3 stoffmasken einheiten bedruckt**  
*Confezioni 3 mascherine stampato*



Schmetterlinge  
*Farfalle*

**REF. 07311**



Herz  
*Farfalle*

**REF. 07312**



Totenköpfe  
*Teschi*

**REF. 07315**



Maulwürfe  
*Pois*

**REF. 07314**



Militär  
*Militare*

**REF. 07313**



## Gehrock Herzen

### Camice con cuori

1  
u.m.vta

40  
box

MOD. 51605128

Schwarz  
Nero

Gehrock mit Mini-Ärmeln, Brustklammer und Mao-Kragen. Mit einer Vordertasche, einer bedruckten und einer unbedruckte Tasche. Mit farbigen Knöpfen, Kleidungsstück auf Taille gearbeitet mit Klammern und mit seitlichen Öffnungen.  
100% Polyester

Camice mini manica con clip sul petto e colletto alla coreana. 1 tasca frontale, 1 tasca color fantasia e un'altra in tinta unita. Chiusura con bottoni colorati, capo aderente con pince e aperture laterali.  
100% poliester

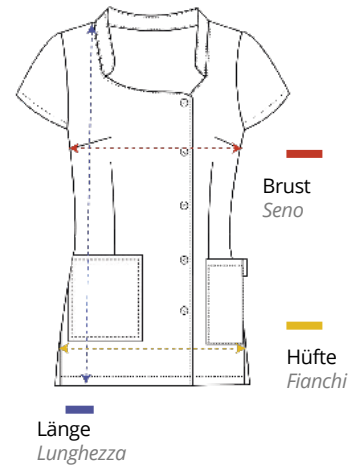

**S**  
98 - 102 cm  
102 - 106 cm  
72 - 74 cm

REF.06297/50/1

**M**  
106 - 110 cm  
108 - 112 cm  
73 - 75 cm

REF.06297/50/2

**L**  
114 - 118 cm  
116 - 120 cm  
75 - 77 cm

REF.06297/50/3

**XL**  
120 - 124 cm  
124 - 128 cm  
77 - 79 cm

REF.06297/50/4

**XXL**  
126 - 130 cm  
136 - 140 cm  
78 - 80 cm

REF.06297/50/5

MOD. 51605128

Weiß  
Bianco

Gehrock mit Mini-Ärmeln, Brustklammer und Mao-Kragen. Mit einer Vordertasche, einer bedruckten und einer unbedruckte Tasche. Mit farbigen Knöpfen, Kleidungsstück auf Taille gearbeitet mit Klammern und mit seitlichen Öffnungen.  
100% Polyester

Camice mini manica con clip sul petto e colletto alla coreana. 1 tasca frontale, 1 tasca color fantasia e un'altra in tinta unita. Chiusura con bottoni colorati, capo aderente con pince e aperture laterali.  
100% poliester

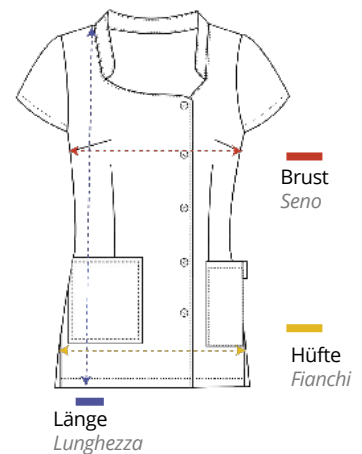

**S**  
98 - 102 cm  
102 - 106 cm  
72 - 74 cm

REF.06297/58/1

**M**  
106 - 110 cm  
108 - 112 cm  
73 - 75 cm

REF.06297/58/2

**L**  
114 - 118 cm  
116 - 120 cm  
75 - 77 cm

REF.06297/58/3

**XL**  
120 - 124 cm  
124 - 128 cm  
77 - 79 cm

REF.06297/58/4

**XXL**  
126 - 130 cm  
136 - 140 cm  
78 - 80 cm

REF.06297/58/5

**Gehrock silberner Rand**  
**Camice argento vivo**

MOD. 51307830

Weiß  
Bianco

Einfarbiger Gehrock mit kurzen Ärmeln, Mao-Kragen und Vorderseite mit silberfarbenem Rand aus Satin, Hinterseite mit Laschverstärkungen und Taschen. Mit rechteckigen seitlichen Metallschnallen, Rücken mit Klammern und seitlichen Öffnungen. Leicht zu bügeln. Sehr atmungsaktives Polyester.  
100 % feines Polyester



Camice semplice con maniche corte, collo alla coreana, orlo frontale con finiture in satin argento e tasche sui fianchi. Chiusura laterale con fermagli metallici rettangolari, pince sulla parte posteriore e aperture laterali. Facile da stirare. Poliestere molto traspirante.  
100 % poliestere fine

S

98 - 102 cm  
104 - 108 cm  
70 - 72 cm

REF.06301/58/1

M

106 - 110 cm  
112 - 114 cm  
70 - 72 cm

REF.06301/58/2

L

114 - 118 cm  
118 - 122 cm  
72 - 74 cm

REF.06301/58/3

XL

120 - 124 cm  
126 - 130 cm  
73 - 75 cm

REF.06301/58/4

MOD. 51307830

Schwarz  
Nero

Einfarbiger Gehrock mit kurzen Ärmeln, Mao-Kragen und Vorderseite mit silberfarbenem Rand aus Satin, Hinterteil mit Laschverstärkungen und Taschen. Mit rechteckigen seitlichen Metallschnallen, Rücken mit Klammern und seitlichen Öffnungen. Leicht zu bügeln. Sehr atmungsaktives Polyester.  
100 % feines Polyester

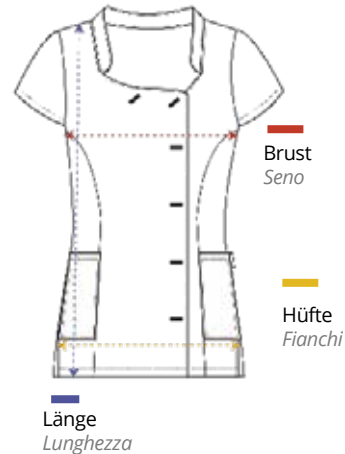

Camice semplice con maniche corte, collo alla coreana, orlo frontale con finiture in satin argento e tasche sui fianchi. Chiusura laterale con fermagli metallici rettangolari, pince sulla parte posteriore e aperture laterali. Facile da stirare. Poliestere molto traspirante.  
100 % poliestere fine

S

98 - 102 cm  
104 - 108 cm  
70 - 72 cm

REF.06301/50/1

M

106 - 110 cm  
112 - 114 cm  
70 - 72 cm

REF.06301/50/2

L

114 - 118 cm  
118 - 122 cm  
72 - 74 cm

REF.06301/50/3

XL

120 - 124 cm  
126 - 130 cm  
73 - 75 cm

REF.06301/50/4



## Gehrock Buddha

### Camice Budda

1 u.m.vta  
40 box

#### MOD. 51605109

Japanischer Gehrock, Ärmel mit Rand Ton in Ton, Brustklammer, Mao-Kragen, Vorderteil mit einem Aufdruck, mit lackierten Schnallen und 1 einfache Tasche. Rücken mit Klammern und Binder zum Verstellen der Taille und der seitlichen Öffnungen. Leicht zu bügeln. Atmungsaktives Polyester. 100% Polyester

Camice con maniche giapponesi, laterale nero, clip sul petto, colletto alla coreana, stampa sulla parte frontale, abbottonato con fermagli laccati e 1 tasca nera. Pince sulla schiena, lacci per regolare il girovita e aperture laterali. Facile da stirare. Poliestere traspirante. 100% poliestere

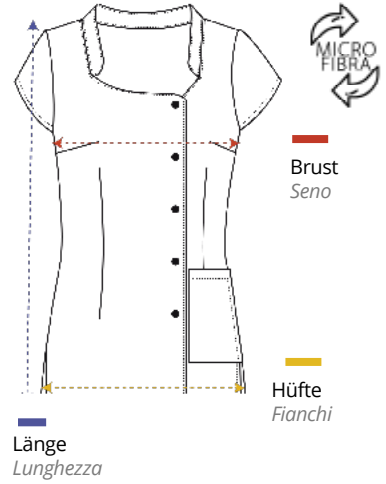

**S**  
94 - 98 cm  
102 - 106 cm  
71 - 73 cm

REF.06300/50/1

**M**  
94 - 98 cm  
102 - 106 cm  
71 - 73 cm

REF.06300/50/2

**L**  
106 - 110 cm  
116 - 120 cm  
75 - 77 cm

REF.06300/50/3

**XL**  
116 - 120 cm  
124 - 128 cm  
77 - 79 cm

REF.06300/50/4

**XXL**  
118 - 122 cm  
130 - 134 cm  
75 - 77 cm

REF.06300/50/5

## Kimono antistatisch

### Kimono antistatico

#### MOD. 21300013

Kimono gekreuzt mit Gürtel und Ärmel 3/4 mit Minitasche am Ärmel. Leicht zu bügeln. Entfärbt nicht. 100% Polyester aus Marokko

Kimono con manica 3/4, cintura e mini tasca sulla manica. Facile da stirare. Non scolora. 100% poliestere marocchino

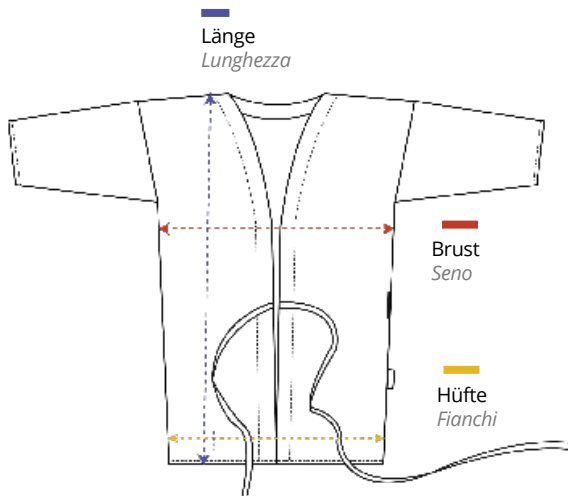

1 u.m.vta  
40 box



123 cm  
123 cm  
104 - 106 cm

REF.06302/50

**Einfache Jacke Reißverschluss**  
Camice basic con zip



MOD. 51308410

Schwarz  
Nero

Einfache Jacke ohne Ärmel. Reißverschluss seitlich. Zusammensetzung 100% Polyester. Zwei Taschen, eine an der Taille und die andere an der Brust. Empfohlen für Geschäfte und Schönheitszentren

Camice senza maniche basic. Chiusura con zip sul lato. Materiale: 100% poliestere. Due tasche, una in vita e una sul petto. Consigliato per negozi e centri estetici.

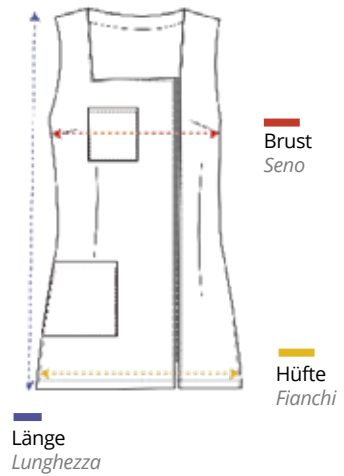

S	M	L	XL	XXL
88 - 92 cm	94 - 98 cm	102 - 106 cm	108 - 112 cm	116 - 120 cm
100 - 104 cm	104 - 108 cm	110 - 114 cm	120 - 124 cm	128 - 132 cm
69 - 71 cm	71 - 73 cm	73 - 75 cm	74 - 76 cm	76 - 78 cm
REF.06298/50/1	REF.06298/50/2	REF.06298/50/3	REF.06298/50/4	REF.06298/50/5

**Stola weiß Mod.**  
Grembiule bianco



MOD. 213014601

Stola 100% Stretch-Polyester. Einstellung am Rücken mit einer Schlaufe, mit großen und bequemen Vordertaschen

Grembiule elasticizzato 100% poliestere. Regolabile sul dietro con fiocco e dotata di ampie e comode tasche frontali.



36 cm
51 cm
78 cm

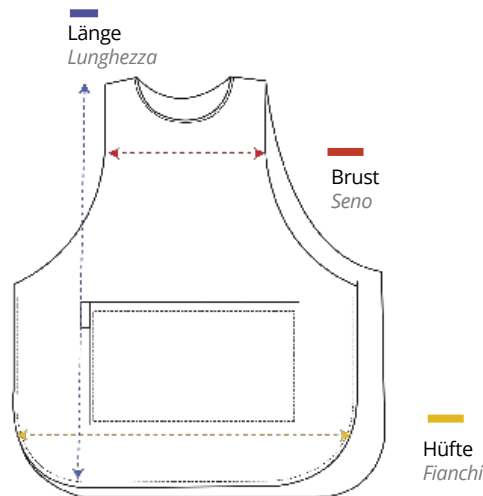

REF.06553/58

## Stola Mao-Kragen

### Camice con colletto coreano

1  
u.m.vta

40  
box

MOD.21602130

Schürzenkittel mit Mao-Kragen mit Metall-Druckknöpfen, Mini-Ärmeln und Front mit Seitentaschen. Er ist mit Bändern verstellbar, die über den Rücken verlaufen und in der Taille gebunden werden.

Camice con colletto alla coreana con bottoni automatici in metallo, mini maniche, e bottoni e tasche frontali. È regolabile con fasce che attraversano la schiena e annodate in vita.



100% Polyester  
100% poliestere

REF.06309/50

100% Polyester  
100% poliestere

REF.06309/63

100% Polyester  
100% poliestere

REF.06309/68

50% Polyester, 50% Baumwolle  
50% poliestere, 50% cotone

REF.06309/72

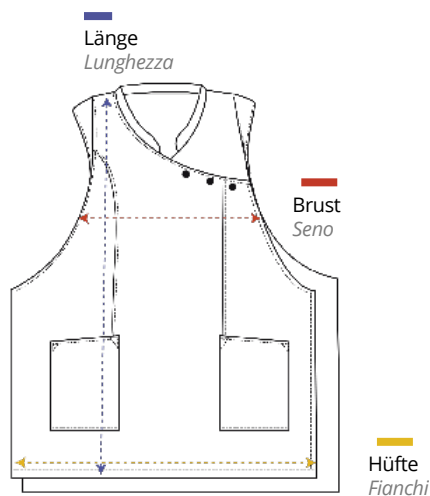

36/37 cm  
59/60 cm  
75/76 cm

## Damenhose

### Pantaloni da donna

1  
u.m.vta

40  
box



#### MOD. 41300011B

» 67% Polyester  
» 33% Baumwolle

» 67% poliestere  
» 33% cotone

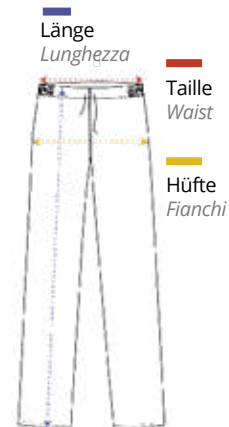

S

92-96 cm  
92-96 cm  
99-101 cm

REF.06312/58/1

M

98-102 cm  
96-100 cm  
101-103 cm

REF.06312/58/2

L

106-110 cm  
106-110 cm  
102-104 cm

REF.06312/58/3

XL

112-116 cm  
114-118 cm  
105-107 cm

REF.06312/58/4

## Ayurveda-Spender mit Holzfuß

### Dispenser Ayurveda con piede in legno

1  
u.m.vta

40  
box

NEW



REF. 03114

## LED-Ringleuchte D.45 cm mit Stativ Anello luminoso a LED D.45 cm con treppiede



REF. 07003

- » Led ring light diameter 18 "
- » Ring light net gewicht: 1,07 kg
- » Ringfarbe: schwarz
- » Leistung: 50w
- » Spannung: ac100 / 240v
- » Stromversorgung: stromkabel
- » Led menge: 288 led beads
- » Farbtemperatur: 2700k / 5700k
- » Led-farbe: pure white / natural white / warm white / cold white
- » 2 Usb-ports
- » Teile: 1 pc mit 18 "led-ringlicht / 3 pc schlauchtelefonhalter / 1 pc fernbedienung
- » Bluetooth shutter / 1 pc von 2,5m. Upright tripod stand / 1 tragetasche
- » Verpackung: getrenntes ringlicht zusammen verpackt & tripod zusammen verpackt

- » Diametro luce anello led 18 "
- » Peso netto anello leggero: 1,07 kg
- » Colore anello: nero
- » Potenza: 50 w.
- » Tensione: ac100 / 240v
- » Alimentazione: cavo di alimentazione
- » Qtà led: 288 perline di led
- » Temperatura colore: 2700k / 5700k
- » Colore led: bianco puro / bianco naturale / bianco caldo / bianco freddo
- » 2 Porte usb
- » Componenti: 1 pezzo di anello di luce a led da 18 "/ 3 pezzi di portacellulari / 1 telecomando
- » Otturatore bluetooth / 1 pz da 2,5m. Supporto per treppiedi verticale / 1 borsa da trasporto
- » Confezione: anello di luce separato imballato insieme e treppiede imballato insieme

NEW



## LED Lichtring DE. 26 cm Tischplatte mit Stativ Anello luminoso a LED DE.26 cm da tavolo con treppiede



REF. 07293

- » Led ring light durchmesser. 10 "
- » Ring light net gewicht: 0,24 kg
- » Ringfarbe: schwarz
- » Leistung: 8 / 12w
- » Spannung: ac85 / 240v
- » Stromversorgung: usb-stromversorgung
- » Led menge: 120 led beads
- » Farbtemperatur: 3000k / 6500k
- » Led-farbe: pure white / natural white / warm white / cold white
- » Teile: 1 pc 10 "led ring light / 1 pc 14 cm desktop tripod stand / 1 pc schlauch
- » Telefonhalter / 1 pc ballkopf / 1 pc telefonklammer / 1 pc fernblau
- » Shutter / 1 pc einstellbarer telefonhalter / 1 pc 1,6 tripod / 1 tasche

- » Diametro luce anello led. 10 "
- » Peso netto anello leggero: 0,24 kg
- » Colore anello: nero
- » Potenza: 8 / 12w
- » Tensione: ac85 / 240v
- » Alimentazione: usb alimentata
- » Qtà led: 120 perline led
- » Temperatura colore: 3000k / 6500k
- » Colore led: bianco puro / bianco naturale / bianco caldo / bianco freddo
- » Parti: 1 luce ad anello led da 10 "/ 1 supporto treppiede da scrivania da 14 cm / 1 tubo flessibile
- » Porta telefono / 1 testa a sfera per pc / 1 clip per telefono per pc / 1 bluetooth remoto per pc
- » Otturatore / 1 porta telefono regolabile da 1 pc / 1 treppiede da 1,6 pc / 1 borsa da trasporto

NEW





## Kosmetikkoffer

### Valigetta portautensili



- » Material: Kunstleder
- » Ideal zum Aufbewahren von Schminkprodukten und kleinen Utensilien.
- » Verschluss: Reißverschluss

- » Materiale: Similpelle
- » Ideale per riporre prodotti per il trucco e piccoli utensili.
- » Chiusura: cerniera lampo

- » Schwarz
- » Nera

**NEW**

REF. 07320/50

- » Fuchsia
- » Fucsia

**NEW**

REF. 07320/63



- » Schwarz
- » Nera

**NEW**

REF. 07321/50

- » Fuchsia
- » Fucsia

**NEW**

REF. 07321/63



### Koffer Aluminium Valigie in alluminio

Alle Koffer werden leer verkauft  
Tutte le valigie vengono vendute vuote



REF.02318



» Für Utensilien, Innenraum transparent und 4 Ablagen  
» Per utensili, interno spazioso composto da 4 scomparti



REF.03598



» Für Utensilien, Innenraum mit 6 Fächern und 4 Ablagen  
» Per utensili, interno spazioso composto da 4 scomparti



REF.03599

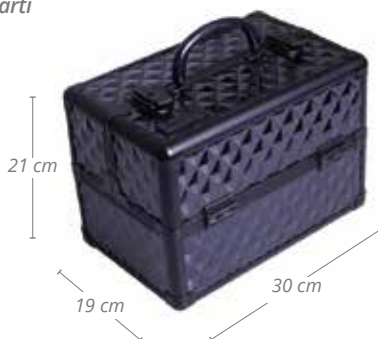

REF.02317

### Koffer Aluminium Valigia in alluminio

- » Alle Koffer werden leer verkauft
- » Tutte le valigie vengono vendute vuote



REF.01492

### Koffer PVC schwarz Valigia in PVC nera

- » Alle Koffer werden leer verkauft
- » Tutte le valigie vengono vendute vuote



REF.02925

### Set aus 3 verschiedenen Koffern PVC Set di 3 valigie assortite in PVC

- » Alle Koffer werden leer verkauft
- » Tutte le valigie vengono vendute vuote



REF.02594

### Trolley-Koffer Valigia trolley

- » Mit Fächern und Spiegel
- » Con scomparti e specchio



## Koffer für Make-up, Kosmetik und Schönheitsbehandlungen

### Valigetta per trucco, cosmetici ed estetica



Mit 4 ausziehbaren Ablagen und mit 12 variablen Fächern. Bietet viel Platz im Inneren, auch für größere Produkte. Umfasst zwei Steckschlösser und zwei Ersatzschlüssel.

Con 4 vassoi estraibili e con 12 scomparti variabili. Dispone di un ampio spazio all'interno per i prodotti più grandi. Include due serrature e due chiavi di riserva.

Mit ausziehbaren Ablagen (2 an jeder Seite). Jede davon mit 4 Ablagen. Großer Innenraum, aufgeteilt in 4 Bereiche. Enthält im Inneren einen Riemen, um den Koffer über die Schulter zu hängen, und zwei Steckschlösser mit zwei Ersatzschlüssel.

Con ripiani estraibili (2 su ogni lato). Ogni ripiano ha 4 scomparti. Ampio spazio interno strutturabile in 4 sezioni. Include all'interno una fascia per appendere la valigia sulla spalla e due serrature con due chiavi di scorta.



## Koffer für Make-up, Kosmetik und Schönheitsbehandlungen

### Valigetta per trucco, cosmetici ed estetica

1  
u.m.vta

4  
box

Mit ausziehbaren Ablagen (2 an jeder Seite). Jede davon mit 4 Ablagen. Großer Innenraum, aufgeteilt in 4 Bereiche. Enthält im Inneren einen Riemen, um den Koffer über die Schulter zu hängen, und zwei Steckschlösser mit zwei Ersatzschlüsseln.

Con ripiani estraibili (2 su ogni lato). Ogni ripiano ha 4 scomparti. Ampio spazio interno strutturabile in 4 sezioni. Include all'interno una fascia per appendere la valigia sulla spalla e due serrature con due chiavi di scorta.



REF.04942/50



REF.04942/54



REF.04942/70

### Trolley-Koffer 4 Bereiche Valigia trolley a 4 blocchi

Alle Koffer werden leer verkauft  
Tutte le valigie vengono vendute vuote



Der Trolley-Koffer von Pollié wurde auf der Grundlage einer Struktur von 2 modifizierbare Bereichen geschaffen, um dem Profi die Lagerung von Friseurutensilien, Make-up oder Kosmetik zu ermöglichen.

Der obere Teil des Koffers besteht aus drei ausziehbaren Ablagen. Von denen Jede in drei Fächer aufgeteilt ist.

In einem davon wiederum finden Sie zwölf kreisförmige Ablagen zur Lagerung von Nagellack, um dessen Abblättern zu verhindern und einen sicheren Transport zu erleichtern. Zudem kann das Innere des oberen Körpers gemäß Ihren Erfordernissen geändert werden, durch Variation der Struktur der Fächer. Schließlich ermöglicht Ihnen seine Funktion 2 in 1, über einen Handkoffer zu verfügen, oder wenn Sie es vorziehen, ihn dank seiner Nylonriemen über die Schulter zu hängen.

Der untere Teil des Koffers hat eine ausziehbare Ablage mit der Möglichkeit, 4 Fächer unterzubringen, ebenfalls modifizierbar, dank der Separatoren. Der untere Körper hat ein hohes Fassungsvermögen und bietet Ihnen die Möglichkeit eines leichteren Transports, da er in einen kleineren Koffer mit Deckel und Spiegel verstaut umgewandelt werden kann. Die Rollen sind über einen Flansch austauschbar. Der Trolley verfügt über zwei Steckschlösser und zwei Austauschschlüssel.

*Il trolley Pollié è concepito sulla base di una struttura a 2 blocchi modificabili ed è studiato per facilitare ai professionisti la disposizione dei propri utensili da parrucchiere, trucco o cosmetici.*

*La parte superiore del trolley è composta da tre vassoi rimovibili. Ognuno di essi è diviso in tre scomparti.*

*A sua volta, in ognuno di essi, troverai dodici scomparti circolari pensati per riporre gli smalti per unghie affinché rimangano fermi facilitando così il loro trasporto in totale sicurezza. Inoltre, l'interno del blocco superiore può essere modificato in base alle proprie esigenze, variando la struttura degli scomparti. Infine, la sua funzione 2 in 1 ti permetterà di avere un bagaglio a mano o se preferisci puoi portarlo a tracolla grazie al suo cinturino in nylon.*

*La parte inferiore della valigia ha un ripiano estraibile con 4 scomparti a scelta, modificabili anche grazie ai divisori. La parte inferiore, con una grande capienza interna, ti darà la possibilità di effettuare un trasporto più leggero poiché può essere convertita in una valigia più piccola, con coperchio e specchio incorporato. Le ruote sono intercambiabili tramite la linguetta di aggancio. Il trolley ha due serrature e due chiavi di scorta.*



### Beutel für Utensilien schwarz Borsa portautensili nera



REF. 02516



## Behälter für Organisation Scatola organizer

Leer  
Vuoto



REF.04722



» Mit Magnet  
» Magnetizzato



REF.04309



## Pulverisator transparent farbig Spruzzatore trasparente colorato



330 ml



REF.00959



300 ml



REF.01372

» Rund  
» Rotondo



300 ml



REF.01484



300 ml



REF.01663

### Kartenetui Aluminium

Portacarte in alluminio

1  
u.m.vta

400  
box

REF.02470



### Flasche Dosierpumpe

Bottiglia con pompetta dosatrice

20  
u.m.vta

80  
box

240 ml

REF.02880



### Augenschutz UV Linse mit Etui

Protezione per gli occhi con lente UV con custodia

10  
u.m.vta

100  
box

- » Modell, das ein neuartiges spezielles System der Halterung umfasst, basierend auf einer transparenten Haarnadel aus Kunststofffaser
- » Mit Etui zur Aufbewahrung des Augenschutzes
- » Modello che comprende un innovativo sistema di bloccaggio speciale basato su una forcella in fibra di plastica trasparente
- » Con astuccio per riporre la protezione

» Umfasst eine zentrale Linse, die der Sicht dient

REF.03195

» Ohne Sicht  
» Senza visione

» Include una lente centrale che consente la visione



REF.03194





Artikel, die ausschließlich in Spanien verkauft werden  
Articoli in vendita esclusiva IN SPAGNA

### Antiseptikum Daromix GH Antisettico Daromix GH



500 ml

REF.06200



### Desinfektionsmittel Limoseptol Disinfettante Limoseptol



50 ml

REF. 06151



1 L

REF.06150



- » AEMPS-Registrierungsnummer: 905-DE5
- » Wasser-alkoholisches Antiseptikum zur hygienischen Händedesinfektion durch Reibung
- » Wissenschaftlich garantierte Wirksamkeit
- » Breites Biozid Spektrum ab 30 sec
- » Hypoallergene Formel
- » Bewahrt die Hautfeuchtigkeit
- » Keine Hautreizung
- » Schnell trocknend
- » Wirksam als: Bakterizid, Levurozid, Viruzid und Mikrobakterizid

- » Numero di registrazione AEMPS: 905-DE5
- » Antisettico idroalcolico per la disinfezione igienica delle mani per sfregamento
- » Efficacia scientificamente garantita
- » Biocida ad ampio spettro a partire da 30 sec
- » Formula ipoallergenica
- » Preserva l'idratazione della pelle
- » Non irritante per la pelle
- » Asciuga velocemente
- » Efficace come: battericida, lieviticida, viricida e microbattericida

- » AEMPS-Registrierungsnummer: 47-DE5
- » Hochwertiges Produkt, das ausschließlich für Hygiene, Reinigung und Desinfektion entwickelt wurde, für professionelle Utensilien eines Salons.
- » Waschmittelwirkung - breites Spektrum
- » Biologisch abbaubar - phosphatfrei und FORMOLFREI
- » Keimtötende und desinfizierende Wirkung gegen: Bakterien, Hefen und Pilze
- » Mischverhältnis
- » 100 ml Produkt = 10 Liter Wasser

- » Numero di registrazione AEMPS: 47-DE5
- » Prodotto di alto livello sviluppato esclusivamente per l'igiene, la pulizia e la disinfezione degli utensili professionali nei centri estetici
- » Azione detergente - Ampio spettro
- » Biodegradabile - Senza fosfati e senza FORMOLO
- » Efficacia germicida e DISINFETTANTE contro: batteri, lieviti e funghi
- » Dose da mescolare
- » 100 ml di prodotto = 10 litri di acqua

## Flasche speziell für hydroalkoholisches gel und hydroalkoholische lösung Bottiglia speciale per gel e soluzione idroalcolica



300 ml

REF.07281



NEW

» Mit wandhalterung  
» Con supporto a parete



300 ml

REF.07280



NEW

## Desinfektionsmittel für oberflächen in sprayform Igienizzante per superfici in spray

Ideal für die Desinfektion und Reinigung jeder Art von Oberfläche:  
Metall, Kunststoff, Glas und Keramik.

- » Möbel, Türen, Geländer, Spielzeug, WCs, Computertastaturen,
- » Mäuse, Bildschirme, Arbeitsplätze

### MERKMALE UND VORTEILE

- » Harmlos beim Kontakt mit der Haut.
- » Schnelle und effektive Reinigungs- und higienisierungswirkung.
- » Verdampft vollständig, ohne Reste zu hinterlassen.
- » Greift Kunststoff oder Gummi nicht an.

*Ideale per igienizzare e pulire qualsiasi tipo di superficie: metallo, plastica, vetro e ceramica.*

- » Mobili, porte, ringhiere, giocattoli, servizi igienici, tastiere di computer, mouse, schermi... luoghi di lavoro

### CARATTERISTICHE E VANTAGGI

- » Innocuo a contatto con la pelle.
- » Rapida ed efficace azione detergente e igienizzante.
- » Evapora completamente senza lasciare residui.
- » Non attacca le plastiche o le gomme.



300 ml

REF.07232



NEW

**Seifenschale Kunststoff**  
**Portasapone in plastica**1  
u.m.vta40  
box

REF.02197

**Saugglocke mit Balg WC**  
**Stantuffo per WC a soffietto**10  
u.m.vta10  
box

REF.00931

**Griff für Besen**  
**Manico di scopa**

- » Leicht zu reinigen und lange haltbar
- » Ständer aus Kunststoff
- » Ideal für jede Art von Boden, insbesondere Parkett

- » Facile da pulire e di lunga durata
- » Gancio in plastica
- » Ideale per tutti i tipi di pavimento, in particolare il parquet



- » Ausziehbar 140 cm
- » □ Allungabile 140 cm

12  
u.m.vta12  
box

REF.01131

- » Extra Teleskopstiel
- » Telescopico



- » Ausziehbar 140 cm
- » Allungabile 140 cm

10  
u.m.vta10  
box

REF.01365

**Gummibesen**  
**Scope di gomma**

- » Mit Lasche
- » Con aletta



REF.01223



REF. 01285/50



- » Leicht zu reinigen und mit langer Lebensdauer, beseitigt den Staub dank der wirksamen Anordnung seiner Borsten, ohne ihn aufzuwirbeln, wodurch er ideal ist für Allergiker, da er ein sauberes Ambiente fördert.
- » Facile da pulire e di lunga durata. L'efficienza del design dei suoi denti riesce a trascinare la polvere senza sollevarla, rendendola ideale per chi soffre di allergie in quanto aiuta a mantenere i locali puliti



REF.02420



08

# Mobiliar

MOBILIA

*Kosmetikstühle, Hocker, Stühle, Ständer,  
Wagen, Handkoffer, Make-up-Stühle...*

*Lettini, sgabelli, sedie, supporti, carrelli,  
valigette, poltrone per il trucco...*

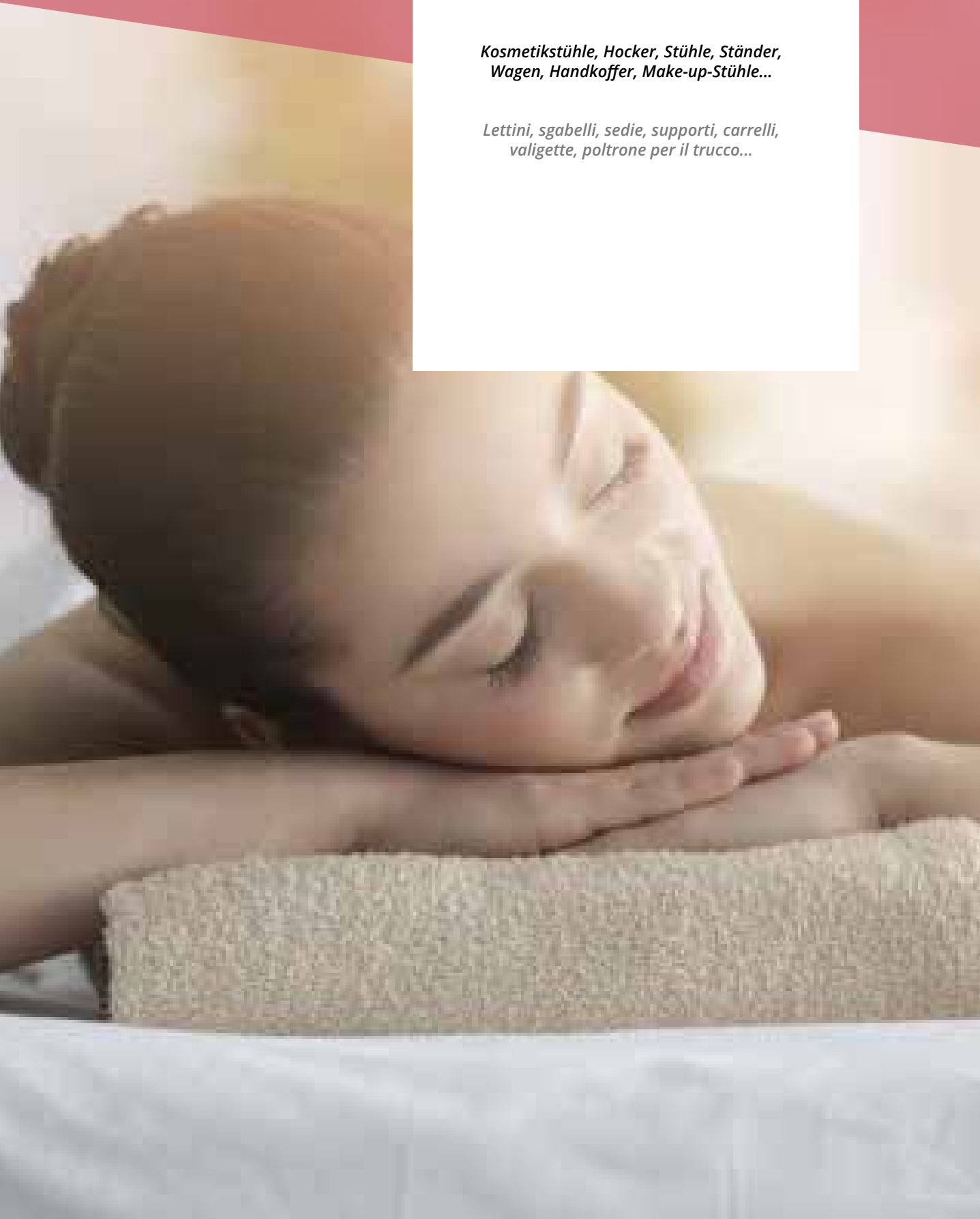

### Kosmetikstuhl für Massage tragbar Lettino da massaggio portatile

1 u.m.vta  
1 box

REF.07384

- » Gewicht: 17,5 kg
- » Peso: 17,5 kg

NEW

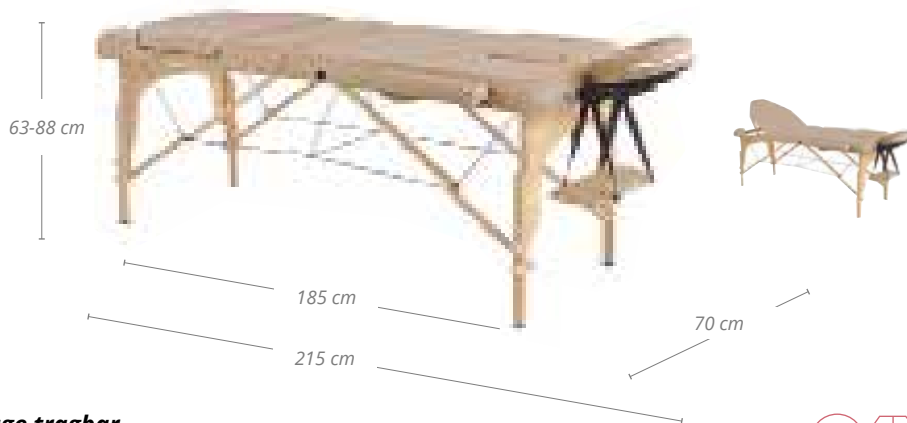

### Kosmetikstuhl für Massage tragbar Lettino da massaggio portatile

1 u.m.vta  
1 box

REF.07385

- » Aluminium
- » Gewicht: 16 kg

- » Alluminio
- » Peso: 16 kg

NEW



### Kosmetikstuhl für Massage tragbar Lettino da massaggio portatile

1 u.m.vta  
1 box

REF.02737

- » Aluminium
- » Gewicht: 16 kg

- » Alluminio
- » Peso: 16 kg



### Kosmetikstuhl Massage Metallstruktur

#### Lettino da massaggio con struttura in metallo

1 u.m.vta 1 box

REF.02738



- » Schaumstoffdichte: 30kg/m<sup>3</sup>
- » Gewicht: 17 kg

- » Densità della spugna: 30kg/m<sup>3</sup>
- » Peso: 17 kg

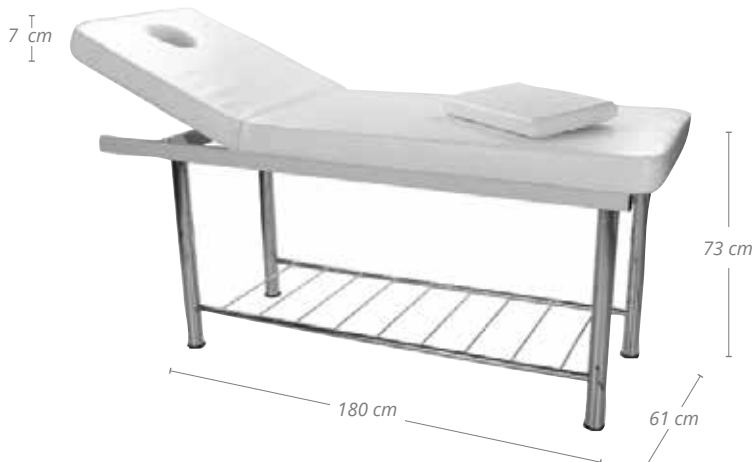

### Kosmetikstuhl spezial Massage

#### Lettino da massaggio speciale

1 u.m.vta 1 box

- » Schaumstoffdichte: 30kg/m<sup>3</sup>
- » Gewicht: 31 kg

- » Densità della spugna: 30kg/m<sup>3</sup>
- » Peso: 31 kg

REF. 02739

REF. 02739/50

REF. 02739/54

REF. 02739/59



Ausziehbare  
Arme  
Braccioli  
smontabili



### Ständer für Papierrollen Kosmetikstuhl

#### Portarotoli per carta copriettino

1 u.m.vta 5 box

REF.01168

- » Ständer für die Wand
- » Supporto a parete

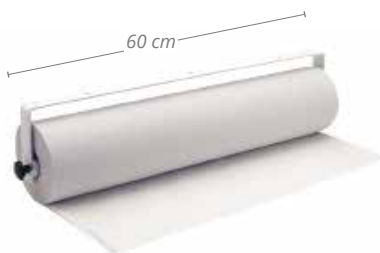

### Hydraulischer Kosmetikstuhl 3 Komponenten Lettino idraulica 3 blocchi



REF. 03031

- » Schaumstoffdichte: 162 kg/m<sup>3</sup>
- » Mit Gesichtslöch unter dem Polster der Kopfstütze
- » Dicke PVC 1,1 / 1,2 cm
- » Weißer Schaumstoff 1. Qualität
- » Bequem, solide und vielseitig
- » Gewicht: 62 kg

- » *Densità della spugna: 162 kg/m<sup>3</sup>*
- » *Con foro per il viso sotto il cuscino del poggiatesta*
- » *Spessore PVC 1,1 / 1,2 cm*
- » *Gommapiuma bianca di prima qualità*
- » *Comodo, solido e versatile*
- » *Peso: 62 kg*



### Elektrischer Kosmetikstuhl 3 Komponenten Lettino elettrico 3 blocchi



REF. 03030

- » Schaumstoffdichte: 162 kg/m<sup>3</sup>
- » Ausziehbare Arme
- » Mit Gesichtslöch unter dem Polster der Kopfstütze
- » Weißer Schaumstoff 1. Qualität
- » Sitz 9,5 cm
- » Bequem, solide und vielseitig
- » 3 Komponenten - 3 Motoren
- » Traglast: 200 kg
- » Gewicht: 70 kg

- » *Densità della spugna: 162 kg/m<sup>3</sup>*
- » *Braccioli smontabili*
- » *Con foro per il viso sotto il cuscino del poggiatesta*
- » *Gommapiuma bianca di prima qualità*
- » *Seduta 9,5 cm*
- » *Comodo, solido e versatile*
- » *3 blocchi - 3 motori*
- » *Supporto 200 Kg*
- » *Peso: 70 kg*





**Spa-Kosmetikstuhl  
Lettino Spa**

REF.03032

- » Kopfstütze NICHT abnehmbar
- » Gewicht: 53 kg

- » Poggiatesta NON rimovibile
- » Peso: 53 kg

**Kleine Leiter Holz Spa  
Scaletta Spa in legno**

REF.03072

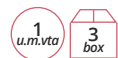
**Satz Sitzkissen Kosmetikstuhl Spa  
Set di cuscini da lettino spa**

REF.03069

- » Klein: 40 cm x Ø 11
- » Groß: 68 cm x Ø 11
- » Quadratisch: 29 x 40 x 6 cm

- » Piccolo: 40 cm x Ø 11
- » Grande: 68 cm x Ø 11
- » Quadrato: 29 x 40 x 6 cm



**Wandschirm Holz Spa**  
Separé spa in legno1  
u.m.vta1  
box

REF.03078

**Regal Holz Spa**  
Scaffale spa in legno1  
u.m.vta1  
box

REF.03071



### Maniküretisch Tavolo da manicure

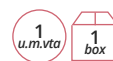

REF.02139

- » Maniküretisch, bestehend aus weißer Holzplatte, Fuß aus Aluminium und thermogeformter Stütze mit Rollen
- » Umfasst Lampe, Handballenauflage aus Schaumstoff und einen praktischen Organizer für Utensilien
- » Ohne Sauger
- » Gewicht: 22 kg

- » *Manicure table made up of a Bianco wooden board, an aluminium base and a thermoformed piece of furniture with wheels*
- » *Includes a lamp, a foam palm rest and a handy organiser for tools*
- » *Weight: 22 kg*
- » *Vacuum cleaner not included*



### Maniküretisch mit Sauger Tavolo da manicure con aspirazione



REF.03067

- » Maniküretisch, bestehend aus weißer Holzplatte, Fuß aus Aluminium und thermogeformter Stütze mit Rollen
- » Umfasst Lampe, Handballenauflage aus Schaumstoff und einen praktischen Organizer für Utensilien
- » Mit Sauger 20 W
- » Gewicht: 22kg

- » *Tavolo per manicure composto da tavolo in legno bianco, gamba in alluminio e mobiletto*
- » *termoformato con ruote*
- » *Include lampada, poggiamani in gommapiuma e un pratico organizer per gli utensili*
- » *Con aspiratore da 20W*
- » *Peso: 22kg*



### Klappbarer Maniküretisch mit Sauger und Rollen

Tavolo da manicure pieghevole con ventosa e ruote



REF.04278

- » Mit Sauger von 3000 rpm  
30 W
- » Gewicht: 12 kg

- » Con aspiratore da 3000 rpm  
30 W.
- » Peso: 12 kg



### Maniküretisch aus weißem Holz

Tavolo da manicure in legno bianco

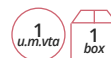

REF.03934

- » Gewicht: 33 kg
- » Peso: 33 kg



### Wagen Schönheitsbehandlung Pollié

Carrello Pollié



REF. 02839



- » Gewicht: 12 kg
- » Peso: 12 kg



### Tischlampe für Maniküre Lampada da tavolo per manicure

- » Lampe in Aluminiumfarbe
- » Neonlicht
- » Maß: 72 cm
- » Wird mit Leuchtröhre von 20 W und zusätzlicher Ersatzröhre geliefert

- » Lampada in alluminio
- » Luce al neon
- » Misure: 72 cm
- » Fornito di lampada fluorescente da 20W e ricambio



REF.03187

### Wagen für Maniküre SMALL Carrello per manicure SMALL



REF.02643/50



REF.02643/58

### Wagen für Maniküre/Pediküre Carrello per manicure/pedicure



REF.03944/50



REF.03944/58

### Rezeptionsschalter aus Holz und Metall Spiegel-Effekt

#### Bancone reception in legno e metallo a effetto specchio

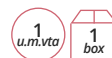

Mit Innenfächern aus Holz zur Lagerung und als Ablage  
 Con scomparti interni in legno per riporre e ripiano

REF.03935



### Wartesofa 3 Plätze

#### Divano attesa 3 posti



» Aus Kunstleder  
 » In simipelle

REF.03950



### Rezeption EARTH Eiche

#### Reception EARTH rovere

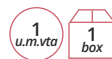

» Graphitbeschichtet  
 » Mit verstellbaren  
 Regalen und 1  
 Schublade

» Laminato in grafite  
 » Con ripiani regolabili e  
 1 cassetto



REF.04518/50

REF.04518/65

REF.04518/58

REF.04518/72

### Hocker STREET

#### Sgabello STREET

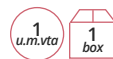

Hocker STREET klassisch mit Hydraulikpumpe zur Einstellung auf die gewünschte Höhe bei jeder Arbeit

*Sgabello STREET classico con pompa idraulica per regolare l'altezza a quella desiderata per ogni lavoro.*



REF.06103/50

45-59 cm



REF.06103/58

45 cm

Vergleichsartikel 04419 - 06103  
Comparativa 04419 - 06103



### Hocker Metallbasis

#### Sgabello con base in metallo



REF.04419/50

50-66 cm



REF.04419/58

### Hocker SWEET SIT

#### Sgabello SWEET SIT



REF.01328

61-71 cm



### Hocker RODEO

#### Sgabello RODEO



REF.01964

58-77 cm



### Hocker URBAN

#### Sgabello URBAN



Hocker URBAN ergonomisch mit Hydraulikpumpe zur Einstellung der Höhe auf die gewünschte bei jeder Arbeit. Seine Form passt sich an den Körper an und fördert damit eine bessere Haltung und verhindert Rückenschmerzen nach vielen Stunden Arbeit  
*Sgabello URBAN ergonomico con pompa idraulica, per regolare l'altezza a quella desiderata per ogni lavoro. La sua forma si adatta al corpo e di conseguenza favorisce una migliore postura e previene il mal di schiena dopo molte ore di lavoro.*



REF.06102/50



REF.06102/58

50-64 cm

45 cm

Vergleichsartikel 04382 - 06102  
 Comparativa 04382 - 06102



### Hocker RODEO Metallbasis

#### Sgabello RODEO con base in metallo



REF.04382/50



REF.04382/58

58-77 cm

### Lehnstuhl

#### Poltrona reclinabile



- » Verstellbar 130° / hydraulisch
- » Breite von Arm zu Arm: 57 cm
- » Breite Oberteil des Stuhls: 19 cm
- » Lehne: 51 x 41 cm
- » Höhe Oberteil: 13 cm
- » Abstand zwischen Lehne und Oberteil: 14 cm
- » Gewicht: 32,5 kg
- » Ausziehbares Oberteil mit einer Position

- » Reclinabile 130° / idraulica
- » Larghezza da bracciolo a bracciolo: 57 cm
- » Larghezza del poggiatesta della sedia: 19 cm
- » Schienale: 51 x 41 cm
- » Altezza del poggiatesta: 13 cm
- » Distanza tra schienale e poggiatesta: 14 cm
- » Peso: 32,5 kg
- » Poggiatesta smontabile con una posizione



REF. 02975/58

54-68,5 cm

51 cm



### Lehnstuhl, verstellbar

#### Poltrone regolabile con schienale



REF.02730/50

REF.02730/58

REF.02730/54

### Verstellbarer Stuhl

#### Poltrona regolabile



REF.02732

REF.02732/58

### Lehnstuhl, verstellbar

#### Poltrone regolabile con schienale



REF.03937/50

REF.03937/58

### Lehnstuhl FASHION

#### Poltrone con schienale FASHION



Stuhl FASHION mit Lehne für mehr Komfort und Abstützung für den Rücken. Die Rollen sind so konzipiert, dass sich das Haar nicht in ihnen verfängt. Leicht zu reinigen

Poltrona FASHION con schienale per un maggiore comfort e sostegno per la schiena. Le ruote sono progettate per evitare che i capelli vi rimangano impigliati. Facili da pulire.



REF.06101/58

### Tattoo-Ständer

#### Poggiabraccio per tatuaggi



REF.04915

- » Verstellbar und kippbar
- » Polsterung: 37 x 21 cm

- » Regolabile e inclinabile
- » Imbottitura: 37 x 21 cm



### Nackenstütze

#### Supporto per la nuca

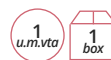

REF.03842

- » Polsterung: 23 x 6 cm
- » Imbottitura: 23 x 6 cm



### Ständer Pediküre

#### Treppiede per pedicure

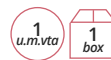

REF.03627

- » Ständer Pediküre 20 x 17 cm
- » kippbar
- » 1,94 kg

- » Supporto per pedicure 20 x 17 cm
- » inclinabile
- » 1,94 kg



### Massagestuhl Poltrona da massaggio

1  
u.m.vta

1  
box



REF.02740/50

REF.02740



### Spezialstuhl Pediküre mit Fußwanne Sedia speciale per pedicure con lavapiedi

1  
u.m.vta

1  
box

REF. 02741

### Spa Pediküre Stuhl Sedia per pedicure spa

» Mit verstellbarer Rückenlehne  
» Con schienale regolabile

1  
u.m.vta

4  
box

REF. 07341

NEW



### Handkoffer mit Schminktisch Valigetta per il trucco

Schminktisch mit 6 klappbaren Leuchten und Rollen. Konvertierbar in einen bequemen Trolley-Koffer + 2 Bechern für Pinsel. Europäische Anschlüsse.

*Mobile da trucco con 6 luci e ruote pieghevoli. Trasformabile in un comodo trolley + 2 portaspazzole. Presa europea.*

1  
u.m.vta

1  
box

17 kg

REF.04937/50



### Handkoffer mit Schminktisch Valigetta per il trucco

17 kg

REF.04937/54



### Kopfstütze schwarz Poggiatesta nero

» Nur geeignet für Ref.-Nr. 06156/50 und 06156/54  
» Adatto solo per rif. 06156/50 e 06156/54

1  
u.m.vta

6  
box

REF.06157



### Make-up-Stuhl klappbar Sedia da trucco pieghevole

» deal für Make-up  
» Ideale per il trucco

1  
u.m.vta

1  
box

17 kg



**Mit Tranporthülle**  
Include custodia per il trasporto

### Aufhänger für Saugnapf

Gancio a ventosa

15  
u.m.vta

15  
box

REF.02904



### Handtuch-Organizer

Organizzatore di asciugamani

1  
u.m.vta

6  
box

REF.04378

65 x 25 x 30 cm

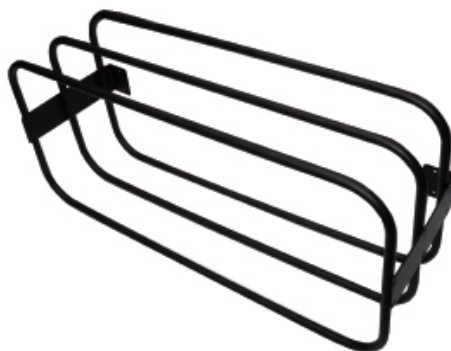

### Handtuchbehälter

Porta asciugamani

1  
u.m.vta

4  
box

REF.03159

- » Mit Rollen
- » Waschbare Taschen
- » Struktur aus Edelstahl

- » Con ruote
- » Borsa contenitore lavabile
- » Struttura in acciaio inox









<b>A</b>			
ABDECKUNGEN UND PAPIERKAMILLA	715 - 716	DIE RASIERUNG CO.	457 - 460
ABGESCHLOSSENE ANWENDERFLASCHEN	67	DIFFUSOREN	22 - 23
ACETATE SHELL COMBS	283 - 285	DISPENSER 100 COMBS EINZELNUTZEN	256
ACRYLGEL	597		
ALUMINIUMPAPIER	68 - 69	<b>E</b>	
ALUMINIUMRINGE	338	EINWEG	724 - 727
ANDREA AUGENBRAUEN	713	EINWEGMESSER	412
ANDREA EYELASHES	707 - 711	EISEN	29 - 38
ANTI-CELLULITE UND FIRMING	551	ENTWIRRUNGSBÜRSTE	227 - 229
ANTICAIDATASSEL	470 - 472	ESCAPER COMB	270 - 271
ARGAN LINE	125	ESCOVAS	365
AUFLADBARER TINNENMISCHER	45	ESMALT-AUSSTELLER	587
		ESSENTIELLE ÖLE	538-539
		EUROSTI TOUCH-UP-SCHNEIDMASCHINEN	376
		EUROSTIL CLIPS	140 - 142
<b>B</b>		EUROSTIL GABELKÄSTCHEN	148 - 149
BABYBÜRSTEN	239	EUROSTIL PROFESSIONAL COMBS	254
BALGBÜRSTE GUMMI GRIFF	224 - 225	EUROSTIL TASCHENMESSER	407
BALGBÜRSTE MIT HOLZGRIFF	213 - 216	EUROSTILBÜRSTEN	434 - 435
BALGBÜRSTEN MIT KUNSTSTOFFGRIFF	218 - 223	EYELASH MASKE	683
BÄLLE	56 - 59		
BARBER APRON LACLA	500 - 501	<b>F</b>	
BARBER ARMCHAIR	476 - 480	FACEPRO	354
BARBER CAPE LACLA	498	FANTASIE FARBEN	116
BARBER LINE BÜRSTEN	431 - 433	FEDERMESSER UND SEINE KLINGEN	408
BARBER LINE CAPES	493 - 495	FERTIGUNGSPRODUKTE	129 - 137
BARBER LINE SCHNEIDMASCHINEN	374		
BARBER LINE SCHÜRZE	496	<b>G</b>	
BARBER LINE TASCHENMESSER	402 - 404	GABELN	145 - 147
BARBER POLO	475	GABELN UND KLIPPEN	143 - 144
BARBER SPRAYS	502	GEL- UND ACRYLBÜRSTEN	601 - 602
BARBER SUITCASES	506 - 507	GELSPENDER	364
BARBERBÜRSTEN	427 - 428	GEPÄCK	344 - 351
BARTKAPITÄN KOCHAUSSTELLER	456	GESICHTSCREME	532-537
BASISÖLE	547 - 549	GESICHTSPFLEGE	529 - 545
BAUMWOLLE	343	GROSSE VERLÄNGERUNGSKLAMMER	339 - 340
BEADER COMB	246 - 248	GUMMIBÄNDER	159 - 162
BEARD COMB - BARBER LINE MUSTACHE	441		
BERGMAN MANNEQUIN HEADS	178	<b>H</b>	
BERGMANN	178	HAAR-VAKUUMREINIGER	48 - 49
BIGUDIES	289 - 292	HAARMASKE	128
BLADES RAGNAR BLADES	409	HAAROXIDANT	114 - 115
BLEISTIFTE	679 - 682	HAARSCHNEIDER UND MESSER	333 - 335
BODY SCRUB	550	HAARTRENNER	492
BÜRSTE SAUBERE KÄMME	445	HALSENSCHUTZ	491 - 492
BÜRSTEN	689 - 695	HALSPAPIER	491
BÜRSTEN	675 - 678	HANDSCHUHE	71 - 72
BÜRSTENANZEIGEN	230 - 231	HELLE FARBFARBE	107-112
		HELLE FARBMASKE	127
<b>C</b>		HERR. BÄRENFAMILIE	461 - 462
CAPTAIN COOK BEARD SHAMPOO	455	HOCKER / STÜHLE	766 - 770
CAPTAIN COOK BEFESTIGUNGSSALBE	450 - 453	HYALURONISCHE CREMEN	531
CAPTAIN COOK COMBS	443	HYALURONISCHE KAPILLAR	122
CAPTAIN COOK CUTTING LAYERS	497	HYGIENE ZUBEHÖR / HYDRO -	360 - 364
CAPTAIN COOK KLASSISCHE	401	ALKOHOLISCHES GEL	
RASIERMASCHINE			
CAPTAIN COOK SCHNEIDMASCHINEN	375	<b>I</b>	
CAPTAIN COOK SHAMPOO	447 - 448	IONI - K.	120 - 121
CAPTAIN COOK TOOLS CASE	512	IONI K 130-131	120-121
CAPTAIN COOK VOLUMISIERENDES PULVER	454		
CARBON COMB	258 - 259	<b>J</b>	
CHAMOU NEUTROS AROMAS	128	JAPANISCHE UND WASCHABDECKUNGEN	65
CLASSIC BARBER LINE RASIERMASCHINE	401		
CLIPS MIT PERLEN	164 - 165	<b>K</b>	
COCKTAILS UND METER	66	KAMMSTUFEN	240
COMBBERS	73 - 74	KAPILLARFASERN	134
CREME- UND FUSSKRATZER	667	KAPITÄN KOCHMESSER	405 - 406
CREMES UND BEHANDLUNGEN	531 - 541	KAPPEN	304 - 309
CREMES UND BEHANDLUNGEN	550 - 552	KERAMIK-THERMISCHE BÜRSTE - IONISCH	241
CREPAR BRUSH	208	KINDERSCHICHTEN	90 - 91
CURLING-BÜRSTE	238	KLEBSTOFF, UM DIE HAARKOSTINEN ZU	340
CUTICLE CUTTER PLIERS	650 - 656	BEFESTIGEN	
<b>D</b>		<b>K</b>	
DATEIEN UND POLIERBLÖCKE	631 - 647	KLINGEN	409 - 411
DEKOKREAM	119	KONJAC-SCHWÄMME	545
DEPILARE ZANGE	580 - 585	KÖRPERPFLEGE	547 - 555
DICHTUNG ENTFRERNER	598 - 600	KRANKENTRAGEN	757 - 760
DIE LEGENDEN	469		

KREISBÜRSTE	209 - 212	SEMI-PERMANENT EMAILLE P-LACK	595 - 596
KUNSTSTOFF-ABNEHMBÜRSTE	237	SET PEINES PROFESIONALES	261 - 262
KUNSTSTOFFKLAMMER	153 - 156	SHAMPOO	122 - 127
<b>L</b>		SIE DENKEN RAGNAR	437 - 440
LACKEN	136-137	SILIKONREINIGER	698
LACLA	92-105	SILKOMB COMB	444
LACLA BARBER CAPES	498	SILLAS BARBERIA NIÑOS	483 - 484
LAMPEN	612 - 617	SILLAS PELUQUERIA	194 - 199
LED-LICHT	743	SILLAS PELUQUERIA NIÑOS	183 - 184
LOUPES	629 - 630	SKELETTBÜRSTEN	232 - 236
<b>M</b>		SPA LINE MÖBEL	761
MAKE-UP TASCHEN UND STÜHLE	771 - 772	SPECIAL PUA COMB	249 - 250
MAKE-UP-SCHWÄMME	684 - 688	SPIEGEL	729 - 734
MANIKÜRE ZUBEHÖR	659 - 663	SPIEGEL	485
MANIKÜRETABELLEN	762 - 763	SPRAYERS	503
MANIKURWAGEN	764	SPRAYERS	357 - 358
MANNEQUIN HEADS MAN BERGMAN	521 - 522	STÄNDIGE ROLLE	168 - 169
MANNEQUIN HEADS NATÜRLICHES HAAR	171 - 175	STAPLES	156 - 158
MANNEQUIN HEADS SYNTHETISCHES HAAR	176 - 177	STERILISATOREN	648 - 649
MASCHINENMATTEN	389	<b>T</b>	
MASCHINENÖLE	388	TABURETES/ REPOSAPIES	185 - 186
MASKEN	735 - 736	TALCO BARBER LINE	429
MASSAGEBÜRSTE	278	TEMPORIZADORES	55
MECHAS BEADING COMB	253	TENACILLAS RIZADORAS	39 - 44
METALLISCHE PINZETTE	150 - 152	THERMISCHE BÜRSTE	242 - 245
MICELLAR WATER	530	TIJERA PELUQUERIA	317 - 329
MYRSOL	464 - 468	TIJERAS BARBER LINE	421
<b>N</b>		TIJERAS CAPTAIN COOK	418 - 420
NAGEL KUNST	603 - 611	TIJERAS ESPECIAL ACADEMIA	330
NAIL CLIPPER UND MANICURE SET	657 - 658	TIJERAS ESPECIAL ZURDOS	425
NATÜRLICHE HAARVORHÄNGE	337	TIJERAS EUROSTIL	422 - 423
NÜTZLICHER HAFEN	352- 353	TIJERAS INICIACION	424
<b>O</b>		TIJERAS RAGNAR	416 - 417
OSMA	463	TINT PALETINES	60 - 64
<b>P</b>		TINTE CAPILAR	107 - 117
PAPILLOTS	293	TIRAS MECHAS	53 - 54
PARAFFIN	618 - 619	TOALLAS	359
PEDICURE SPEZIFISCH	664 - 673	TOALLAS CELULOSA/ SPUNLACE	508
PEN RAZOR, SCHÄUME UND GELS	413	TOALLAS Y SABANAS	718 - 721
PEUCOS	363	TÖNUNGSZUBEHÖR	51 - 52
PNEUMATISCHE BÜRSTE	226	TORNOS	620 - 621
POLLIE EMAILLE	587 - 593	TRAGBARE SCHEIBE	200 - 201
POLLIE EYELASHES	701 - 706	TRATAMIENTO VENDAS FRIAS	554
PULVERIZADOR BARBERO	502 - 505	TRIMS SOFTENER	667
<b>R</b>		TROCKENSHAMPOO	122
RAGNAR COMBS	440	TROCKNERHALTER	356
RAGNAR-SCHNEIDMASCHINEN	371 - 373	TROLLEYS	201- 204
RAGNARMESSER	399 - 400	TROLLEYS UND TROMMEL	486
RECAMBIOS TORNOS	622 - 628	TURBANTES	163
RECYCLED MATERIAL COMB	437-439	<b>U</b>	
RECYCLING BRUSH LINE	286-287	UMKLEIDERAUM	737 - 742
REDES	302 - 303	UNTERLEGSSCHEIBE	188 - 193
REINIGUNGSMILCH	529	<b>V</b>	
REINIGUNGSTONIK	529	VAPORALES Y ACCESORIOS	543 - 545
RELLENOS MOÑO	311 - 315	VARIOS / LAVACABEZAS	205
RETOCA-WURZELN	133	VERFÄRBUNGEN	118-119
REZEPTION	765	VERSCHIEDENE MÖBEL	773
ROBES, KIMONOS UND SCHÜRZEN	88 - 89	VESTUARIO	178
ROLL - ON CERA HOMBRE	473	<b>W</b>	
RULOS	294 - 301	WACHSFORMAT KG	557 - 561
<b>S</b>		WACHSFORMAT ROLL-ON	568 - 570
SCHERENKOFFER	331 - 333	WACHSSICHERUNGEN	562 - 565
SCHICHTEN	78	WERKZEUG-BRIEFCASE	744
SCHICHTEN EINE VERWENDUNG	75 - 77	WOW EFFEKTBHANDLUNG	129
SCHNEIDEN UND TÖTEN VON SCHICHTEN	79 - 80	<b>Z</b>	
SCHNEIDSCHICHTEN	81 - 85	ZÄHLER UND SPIEGEL	181 - 182
SCHOCKIERENDER KAMM	251 - 252	ZUBEHÖR / HYGIENE	363 - 366
SCHÜTZER	70	ZUBEHÖR WACHS KG	566 - 567
SCHWARZE MASKE	530	ZUBEHÖR WACHSROLLE - EIN	571 - 579
SECADORES	9 - 21	ZUSATZTABELLEN	202
SECADORES CASCO	24 - 28		

ÍNDICE · INDEX

<b>A</b>		DISTRIBUTORI GEL	364
ACCAPPATOI, KIMONOS E GREMBIULI	88 - 89	<b>E</b>	
ACCESSORI / IGIENE	363 - 366	ELASTICI	159 - 162
ACCESSORI CERA KG	566 - 567	ESCAPER COMB	270 - 271
ACCESSORI PER IGIENE / GEL IDRO - ALCOLICO	360 - 364	ESCOVAS	365
ACCESSORI PER MANICURE	659 - 663	ESMALT ESPOSITORE	587
ACCESSORI PER TINTA	51 - 52	ESSICCATORI	9 - 21
ACCESSORI WAX ROLL - ON	571 - 579	ESSICCATORI CASCO	24 - 28
ACQUA MICELLARE	530	EUROSTI MACCHINE DA TAGLIO PER RITOCOCCO	376
ADESIVO PER ATTACCARE I COSTINI DEI CAPELLI	340	EUROSTIL CLIPS	140 - 142
AMMORBIDENTE PER FINITURE	667	EUROSTIL PROFESSIONAL PETTINI	254
ANDREA CIGLIA	707 - 711		
ANDREA SOPRACCIGLIA	713	<b>F</b>	
ANELLI IN ALLUMINIO	338	FACEPRO	354
ANTICAIDATASSEL	470 - 472	FERRI	29 - 38
ANTICELLULITE E RASSODANTE	551	FIBRE CAPILLARI	134
AROMI NEUTRO DI CHAMOU	128	FIOCCO IMBOTTITO	311 - 315
ASCIUGAMANI	359	FORBICI BARBER LINE	421
ASCIUGAMANI E LENZUOLA	718 - 721	FORBICI DA ACCONCIATURA	317 - 329
ASCIUGAMANI IN CELLULOSA / SPUNLACE	508	FORBICI EUROSTIL	422 - 423
ASPIRAPOLVERE PER CAPELLI	48 - 49	FORBICI PER INIZIAZIONE	424
		FORBICI RAGNAR	416 - 417
		FORBICI SPECIAL ACADEMY	330
		FORBICI SPECIALI PER SINISTRA	425
		FORCHE E CLIP	143 - 144
		FORCHETTE	145 - 147
		FORMATO CERA KG	557 - 561
		FUSORI A CERA	562 - 565
<b>B</b>		<b>G</b>	
BAGAGLIO	344 - 351	GEL ACRILICO	597
BANCO DELLA RECEPTION	765	GRAFFE	156 - 158
BARBA CAPITANO COOK ESPOSITORE	456	GREMBIULE DA BARBIERE LACLA	500 - 501
BARBIERE SPRUZZATORE	502 - 505	GREMBIULE LINEA BARBIERE	496
BARELLE	757 - 760	GUANTI	71 - 72
BEADER COMB	246 - 248		
BERGMANN	178	<b>I</b>	
BIGUDIES	289 - 292	IONI - K	120 - 121
BOTTIGLIE APPLICATORI GRADUATE	67	IONI K 130-131	120-121
		IRRORATORI	503
		IRRORATORI	357 - 358
<b>C</b>		<b>K</b>	
CAPILLARE IALURONICO	122	KONJAC SPUGNE	545
CAPITANO CUOCO FORBICI	418 - 420		
CAPITANO CUOCO PETTINI	443	<b>L</b>	
CAPS	304 - - 309	LA RASATURA CO.	457 - 460
CAPTAIN COOK FISSAGGIO UNGUENTO	450 - 453	LACCHE	136-137
CAPTAIN COOK POLVERE VOLUMIZZANTE	454	LACLA	92-105
CAPTAIN COOK SHAMPOO	447 - 448	LAME	409 - 411
CAPTAIN COOK TAGLIO STRATI	497	LAME LAME RAGNAR	409
CARRELLI	201- 204	LAMPADE	612 - 617
CARRELLI E TAMBURO	486	LATTE DETERGENTE	529
CARRELLO PER MANICURE	764	LE LEGGENDE	469
CARTA ALLUMINIO	68 - 69	LENTI	629 - 630
CARTA PER IL COLLO	491	LIME E BLOCCHI DI LUCIDATURA	631 - 647
CIGLIA POLLIE	701 - 706	LINEA ARGAN	125
CLIP CON PERLE	164 - 165	LINEA CURA DEL CORPO	547 - 555
CLIP DI GRANDI ESTENSIONI	339 - 340	LINEA CURA DEL VISO	529 - 545
COCKTAIL E METRI	66	LINEA PENNELLI RICICLAGGIO	286-287
COLORI FANTASIA	116	LINEA TALCO BARBER	429
COLTELLI CAPTAIN COOK	405 - 406	LIVELLI DI PETTINE	240
COLTELLI DA TASCA BARBER LINE	402 - 404	LUCE A LED	743
COLTELLI DA TASCA EUROSTIL	407		
COLTELLI MONOUSO	412	<b>M</b>	
COLTELLI PIUMA E LE SUE LAME	408	MACCHINA DA BARBA CLASSIC LINE BARBER	401
COLTELLI RAGNAR	399 - 400	MACCHINA DA BARBA CLASSICA CAPTAIN COOK	401
CONTATORI E SPECCHI	181 - 182	MACCHINE DA TAGLIO CAPTAIN COOK	375
COPERTINE E CAMILLA DI CARTA	715 - 716	MACCHINE DA TAGLIO LINEA BARBIERE	374
COPERTURE GIAPPONESI E DA LAVAGGIO	65	MACCHINE DA TAGLIO RAGNAR	371 - 373
COTONE	343	MANICO IN GOMMA A SPAZZOLA A SOFFIETTO	224 - 225
CREMA E SCRUB PIEDI	667	MANTELLE DA BARBIERE LACLA	498
CREME E TRATTAMENTI	531 - 541	MANTELLI BARBER LINE	493 - 495
CREME E TRATTAMENTI	550 - 552	MANTELLO DA BARBIERE LACLA	498
CREME IALURONICHE	531		
CREME PER IL VISO	532-537		
<b>D</b>			
DECOCREAM	119		
DETERGENTE SILICONE	698		
DIFFUSORI	22 - 23		
DISPENSER 100 PETTINI MONOUSO	256		
DISPLAY A PENNELLO	230 - 231		

ÍNDICE · INDEX

MASCHERA COLORE BRILLANTE	127	SET PER TAGLIO UNGHIE E MANICURE	657 - 658
MASCHERA NERA	530	SET PETTINI PROFESSIONALI	261 - 262
MASCHERA PER CAPELLI	128	SGABELLI / POGGIAPIEDI	185 - 186
MASCHERA PER CIGLIA	683	SGABELLI / SEDIE	766 - 770
MASCHERE	735 - 736	SHAMPOO	122 - 127
MATERIALE RICICLATO PETTINE	437-439	SHAMPOO DA BARBA CAPTAIN COOK	455
MATITE	679 - 682	SHAMPOO SECCO	122
MECHAS BEADING PETTINE	253	SHOCKING COMB	251 - 252
MISCELATORE TINTA RICARICABILE	45	SIG. FAMIGLIA DI ORSO	461 - 462
MOBILI LINEA SPA	761	SMALTO SEMIPERMANENTE P-LACK	595 - 596
MOBILI VARI	773	SPAZZOLA A SOFFIETTO CON MANICO IN LEGNO	213 - 216
MONOUSO	724 - 727	SPAZZOLA ARRICCIATURA	238
MYRSOL	464 - 468	SPAZZOLA CIRCOLARE	209 - 212
<b>O</b>		SPAZZOLA DA MASSAGGIO	278
OLI BASE	547 - 549	SPAZZOLA DETANGLING	227 - 229
OLI ESSENZIALI	538-539	SPAZZOLA DISTACCANTE IN PLASTICA	237
OLI PER MACCHINE	388	SPAZZOLA PNEUMATICA	226
OSMA	463	SPAZZOLA TERMICA	242 - 245
OSSIDANTE PER CAPELLI	114 - 115	SPAZZOLA TERMICA IN CERAMICA - IONICA	241
<b>P</b>		SPAZZOLE	689 - 695
PALETINE DI TINTE	60 - 64	SPAZZOLE	675 - 678
PALLINE	56 - 59	SPAZZOLE A SCHELETRO	232 - 236
PAPILLOTS	293	SPAZZOLE A SOFFIETTO CON MANICO IN PLASTICA	218 - 223
PARAFFINA	618 - 619	SPAZZOLE BARBER LINE	431 - 433
PENNA RASOIO, SCHIUME E GEL	413	SPAZZOLE DA BARBIERE	427 - 428
PENNELLI IN GEL E ACRILICO	601 - 602	SPAZZOLE EUROSTIL	434 - 435
PENNELLO CREPAR	208	SPAZZOLE PER BAMBINI	239
PENSI RAGNAR	437 - 440	SPECCHI	729 - 734
PETTINE DA BARBA - BAFFI BARBER LINE	441	SPECCHI	485
PETTINE DI CARBONIO	258 - 259	SPECIFICO PER PEDICURE	664 - 673
PETTINE DI SETA	444	SPOGLIATOIO	737 - 742
PETTINE PUA SPECIALE	249 - 250	SPOGLIATOIO	178
PETTINI	73 - 74	SPRAY DA BARBIERE	502
PETTINI DI PULIZIA CON SPAZZOLA	445	SPUGNE PER IL TRUCCO	684 - 688
PETTINI DI RAGNAR	440	STERILIZZATORI	648 - 649
PETTINI IN ACETATO	283 - 285	STRATI	78
PEUCOS	363	STRATI PER BAMBINI	90 - 91
PINZE ARRICCIATRICI	39 - 44	STRATI UN USO	75 - 77
PINZE DEPILARI	580 - 585	STRISCE WICKED	53 - 54
PINZE PER TAGLIERINA PER CUTICOLE	650 - 656	<b>T</b>	
PINZETTE METALLICHE	150 - 152	TAGLIERINA E COLTELLI	333 - 335
POLLIE SMALTO	587 - 593	TAGLIO E TINTEGGIATURA STRATI	79 - 80
POLO DA BARBIERE	475	TAGLIO STRATI	81 - 85
POLTRONA DA BARBIERE	476 - 480	TAPPETI PER MACCHINE	389
PORTA ASCIUGATRICE	356	TAVOLI AUSILIARI	202
PORTA UTILE	352 - 353	TAVOLI MANICURE	762 - 763
PRODOTTI DI FINITURA	129 - 137	TENDE DI CAPELLI NATURALI	337
PROTEZIONI	70	TESTE DI MANICHINI BERGMAN	178
PROTEZIONI PER IL COLLO	491 - 492	TESTE DI MANICHINO CAPELLI NATURALI	171 - 175
PULIZIA DEL CORPO	550	TESTE DI MANICHINO CAPELLI SINTETICI	176 - 177
		TESTE DI MANICHINO UOMO BERGMAN	521 - 522
<b>R</b>		TIMER	55
RADICI DI RETOCA	133	TINTA COLORE BRILLANTE	107-112
RETI	302 - 303	TINTURA CAPILLARE	107 - 117
RICAMBI TORNII	622 - 628	TONICO DETERGENTE	529
ROLL - ON WAX MAN	473	TORNII	620 - 621
ROLL-ON IN FORMATO CERA	568 - 570	TRATTAMENTO DI VENDITA A FREDDO	554
RONDELLA	188 - 193	TRATTAMENTO EFFETTO WOW	129
RONDELLA PORTATILE	200 - 201	TURBANTI	163
RULLI	294 - 301	<b>U</b>	
RUOLO PERMANENTE	168 - 169	UNGHIE ART	603 - 611
<b>S</b>		<b>V</b>	
SACCHETTI E SEDIE PER IL TRUCCO	771 - 772	VALIGETTA DEGLI STRUMENTI	744
SCATOLE A MORSETTO IN PLASTICA	153 - 156	VALIGIA DEGLI STRUMENTI DEL CAPITANO	512
SCATOLE FORCELLA EUROSTIL	148 - 149	COOK	
SCOLORAZIONI	118-119	VALIGIA PER FORBICI	331 - 333
SEAL REMOVER	598 - 600	VALIGIE DA BARBIERE	506 - 507
SEDIE DA BARBIERE PER BAMBINI	483 - 484	VAPORI E ACCESSORI	543 - 545
SEDIE DA PARRUCCHIERE	194 - 199	VARIE / RONDELLE	205
SEDIE DA PARRUCCHIERE PER BAMBINI	183 - 184		
SEPARATORI PER CAPELLI	492		

**KATALOG / CATALOGO**  
**2021**

*Offizieller Distributor von:  
Distributore ufficiale di:*

*Eurostil, Pollié, Tassel, Barber Line, Ragnar, Dousse, Myrsol, Captain Cook, Panasonic, Vasso,  
Elios, Derby, Derby Premium, Persona, Supermax, Bic, Mr.Bear Family,  
Feather, Medisana, Maniquick, Promed, Clipp-aid, Facepro, Piccolo, Famex, CeriottiEspabite,  
Ringlets, Pegasus, Matador, Osma, Andrea, Bergmann, Lacla, The Legends, Daromix,  
Limoseptol, Ondina, Sabrina, Beautene, Tessiltaglio*



[www.eurostil.com](http://www.eurostil.com)



*C/Ciudad de Asunción 56 · Barcelona 08030 (Spain)  
Tel. +34 93 274 07 84 · Fax. +34 93 311 89 56  
[ventas@eurostil.com](mailto:ventas@eurostil.com) · [export@eurostil.com](mailto:export@eurostil.com)*

CATÁLOGO 2021 ITALIANO / ALEMÁN



8423029090005