

CATALOGUE / CATÁLOGO

2021

Coiffure

CABELEIREIRO



Barbier

BARBEARIA

Barber Line 

Esthétique

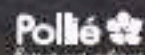
ESTÉTICA

De grandes expériences créent des produits de grande qualité **Grandes experiências criam produtos de grande qualidade**

Industrias Oriol a été créée en 1942 par Don Narciso Oriol Quintana à Barcelone. Au fil du temps, cette entreprise familiale a grandi petit à petit, acquiert de l'expérience et a amélioré la fabrication et la distribution de ses produits dans le monde entier. Il s'agit d'une des plus prestigieuses entreprises de son secteur. Actuellement, elle exporte vers les cinq continents et possède une filiale récemment ouverte à Buenos Aires, en Argentine. Tous ses efforts ont été couronnés par une croissance vertigineuse qui l'a conduit à élargir et moderniser ses installations. À l'heure actuelle, elle dispose d'une usine moderne, d'un vaste entrepôt et de grands bureaux, couvrant une superficie totale de plus de 16.000 m² à Barcelone. La société dispose de plusieurs départements pour développer les produits nécessaires aux coiffeurs professionnels, coiffeurs et esthétiques tels que: fabrication de produits cosmétiques, estampage, injection de matières plastiques, injection de caoutchouc et de silicone, métallurgie, fabrication de tous types de brosses; manipulé du papier et non tissé, des sections de marquage, manipulé et emballage, ainsi qu'un département de conception et d'enquête. Afin d'élargir notre gamme de produits, nous avons inclus dans notre catalogue d'autres marques de prestige national et international, telles que:

PANASONIC, MYRSOL, MR BEAR FAMILY, CAPITAINE COOK, PEN RAZOR, ELIOS, LACLA, ETC.

Dans ce nouveau catalogue, nous voulons partager avec vous nos dernières nouveautés sans oublier nos articles habituels. Nous travaillons pour vous offrir la qualité que vous nous exigez. Nous voulons être à vos côtés. L'expérience compte! Nous sommes convaincus que de grandes expériences créent de bons produits.

Industrias Oriol s'engage depuis des années dans la responsabilité sociale des entreprises en collaborant à plusieurs projets d'assistance sociale et d'intégration sociale, en plus de mener une stratégie d'économie circulaire conçue pour la durabilité et les économies d'énergie.

A Industrias Oriol foi criada em 1942 por Don Narciso Oriol Quintana em Barcelona. Ser uma empresa familiar, que vem crescendo pouco a pouco, adquirindo experiência e aprimorando-se na fabricação e distribuição de produtos de todo o mundo. Sendo uma das melhores e mais reconhecidas empresas do setor. Exporta atualmente para os cinco continentes e tem uma subsidiária recém-inaugurada em Buenos Aires, Argentina. Todo esse esforço foi coroado em um crescimento vertiginoso que levou a expandir e modernizar as instalações. Atualmente, tem uma fábrica moderna, um grande armazém e grandes escritórios, cobrindo uma área total de mais de 16.000 m² em Barcelona.

A empresa possui vários departamentos para desenvolver os produtos necessários exigidos pelo profissional cabeleireiro, barbeiro e estética, tais como: fabricação de cosméticos, estampagem, injeção de plásticos, injeção de borracha e silicone, metalurgia, fabricação de todos os tipos de escovas; Manipulação de papel e não-tecidos, seções de marcação, manipulação e embalagem bem como um departamento de design e pesquisa. Para oferecer uma gama mais ampla de produtos, introduzimos em nosso catálogo outras marcas de prestígio nacional e internacional, tais como:

PANASONIC, MYRSOL, FAMÍLIA DE URSO, COZINHEIRO DE CAPITÃO, PEN RAZOR, ELIOS, LACLA, ETC.

Neste novo catálogo, queremos compartilhar com você as últimas novidades sem esquecer nossos artigos usuais. Nós trabalhamos para oferecer a você a qualidade que você precisa. Nós queremos estar ao seu lado. A experiência conta! Estamos convencidos de que grandes experiências criam ótimos produtos.

Industrias Oriol está comprometida com a Responsabilidade Social Corporativa há anos colaborando em vários projetos de assistência social e integração social, além de executar uma estratégia de economia circular projetada para sustentabilidade e economia de energia.



Une entreprise familiale
Empresa familiar



Après plus de 78 ans d'histoire, la troisième génération de la famille a rejoint l'entreprise, apportant des idées, de nouveaux projets et un grand enthousiasme pour faire croître et consolider l'entreprise.

Une famille qui unit ses forces et lutte pour un projet commun, fruit de la passion de Narcís Oriol Quintana, qui a su la transmettre de génération en génération.

C'est désormais également un fait établi la création de sa filiale EUROSTIL ARGENTINA S.A. qui est née il y a dix ans en arrière. Celle-ci fabrique et commercialise des produits de haute qualité pour le marché latino-américain en ouvrant des frontières et en élargissant son marché.

Cette philosophie des affaires et de famille est le fruit d'un travail bien fait depuis déjà 78 ans. Grâce à l'aide de tout le monde, Industrias Oriol est devenue une grande famille. Nous nous efforçons toujours davantage pour être une référence du marché en ce qui concerne la qualité, le service et le design. Nous vous remercions pour nous faire confiance.

Após mais de 78 anos de história, a terceira geração ingressou na empresa, contribuindo com novas ideias, projetos e entusiasmo, no crescimento e consolidação da empresa.

Uma família que une suas forças e luta, em um projeto comum que nasceu da ilusão de Don Narciso Oriol Quintana, que tem sido capaz de transmiti-lo de geração em geração.

É também um fato a abertura há 10 anos da subsidiária em Buenos Aires, Argentina, com o nome EUROSTIL ARGENTINA S.A. Eles fabricam e comercializam produtos de alta qualidade para o mercado latino-americano. Abrindo fronteiras e expandindo o mercado.

Esta é a filosofia empresarial e familiar, que surge do resultado de um trabalho bem feito há 78 anos.

Com a ajuda de todos, a Oriol Industries tornou-se uma grande família. Continuamos trabalhando para ser uma referência no mercado, pela qualidade, desempenho e design. Obrigado por confiar em nós!

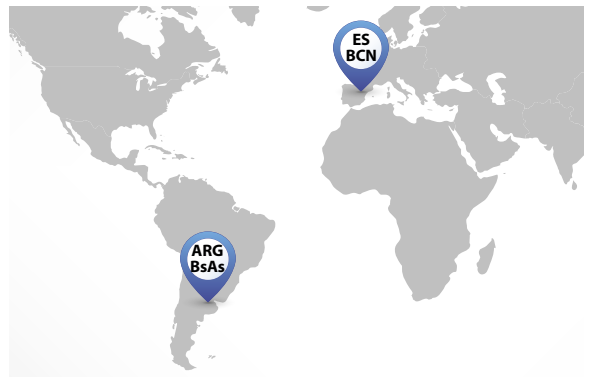

Il est important d'avoir une bonne organisation
É importante ter uma boa organização



1



2



3



4



5



Apprenez à mieux nous connaître avec cette vidéo!
Conheça-nos melhor com este vídeo!

1. Bureaux · *Escritórios*
2. Département de design · *Departamento de design*
3. Section Brosses · *Seção de escovas*
4. Section d'injection plastique · *Seção de injeção de plástico*
5. Section de papier · *Seção de papel*

Service technique
Serviço técnico



Industrias Oriol met à votre disposition un Service Technique pour réparer les pannes et toute anomalie de fonctionnement de nos appareils électriques. La création de ce département nous permet d'améliorer notre service après-vente et de réduire considérablement les délais de réparations. Celles-ci sont effectuées en interne par un personnel hautement qualifié. Notre objectif est de donner le meilleur service à notre clientèle. Pour toute information complémentaire sur notre service après-vente, n'hésitez pas à nous contacter.

Na Industrias Oriol, colocamos à sua disposição o Departamento de Serviços Técnicos, projetado para reparar e resolver qualquer mau funcionamento ou disfunção que possa ter surgido em qualquer um de nossos aparelhos elétricos.

Com a criação deste Departamento, pretendemos melhorar o atendimento, sermos mais eficientes, agilizando o tempo nos possíveis reparos de nossos produtos. Estes são feitos internamente com pessoal especializado. Nosso objetivo é oferecer melhores serviços aos nossos clientes. Se você precisar de mais informações sobre nosso serviço técnico, não hesite em nos contatar.

Laboratoire de produits cosmétiques et de recherche
Laboratório cosmético e pesquisa



Nous disposons d'un laboratoire qui se consacre à faire de la recherche, à développer et innover de nouveaux produits cosmétiques. Notre nouvelle marque TASSEL COSMETICS a été créée pour offrir à nos clients des produits de cosmétique capillaire, corporelle et faciale de haute qualité. Notre objectif est de nous démarquer. Les formules et les ingrédients de nos articles sont soigneusement testés et sélectionnés. Tous nos produits sont enregistrés auprès du Ministère de la Santé et sur le site du portail du nouveau règlement européen des cosmétiques.

Na Industrias Oriol temos também um Laboratório dedicado à pesquisa, desenvolvimento e fabricação de novos produtos na área de cosméticos.

A nova marca, TASSEL COSMETICS, foi criada para oferecer aos nossos clientes produtos de alta qualidade em cosméticos para os cabelos, corpo e rosto.

Nosso objetivo é notar a diferença. Os ingredientes e fórmulas são cuidadosamente testados e selecionados.

Todos os nossos produtos são registrados no Ministério da Saúde e no Portal do Novo Regulamento Europeu de Cosméticos.

Placez votre commande d'une manière simple Faça seu pedido de maneira simples



Ous pouvez placer la commande aisément où vous voulez et comme vous voulez : via web (B2b), par téléphone, courriel ou fax... Le B2B est dorénavant adapté aux téléphones portables et tablettes afin que vous puissiez une commande en un clin d'œil où et quand vous voulez.z.

Pode fazer seu pedido confortavelmente de onde e como quiser: via página web (B2B), por telefone, por e-mail, fax ... o B2B agora está adaptado para telefones celulares e tablets para que você possa fazer qualquer pedido de maneira fácil e conveniente, onde quer que esteja.



Le minimum de commande est de 450€ hors frais de transport. La quantité minimum de vente de chaque article est indiquée dans notre catalogue. Le retours de marchandise seront acceptés dans un délai maximum de 60 jours à compter à partir de la date de livraison de la marchandise et ceseulement et uniquement si Industrias Oriol a donné son autorisation.

A encomenda mínima para Portugal é de € 500,00 . A unidade mínima de venda de cada produto está indicada no catálogo. As devoluções serão aceites no prazo de 60 dias após a recepção da mercadoria, com o consentimento expresso da Industrias Oriol.



Pour faciliter la préparation de votre commande, veuillez indiquer clairement la quantité et le code de l'article. Il est souhaitable d'indiquer la description complète ou partielle du produit.

De acordo com a ordem de prioridade, indique a referência e quantidade de produção dos produtos, mas é importante indicar a descrição do produto ou parte dele.



Por que la commande soit franco de port, le montant doit s'élever a minimum à 900€. Pour tout autre pays, veuillez consulter notre service export (export@eurostil.com)

As encomendas superiores a € 1000,00 beneficiam de portes de envio gratuitos em Portugal Continental, exceto na seguinte situação: se o pedido incluir móveis, papel de pescoço, rampas de lavagem ou mercadorias que ocupem muito espaço / volume, Industrias Oriol cobre 6% do pedido total. Caso o custo de transporte seja superior a 6%, a diferença entre os valores. Para outros países, consulte o departamento export (export3@eurostil.com)



Pour toute information complémentaire à propos d'un produit, vous pouvez nous contacter par courriel info@eurostil.com ou nous appeler au (34) 93 274.07.84. Nous serons heureux de pouvoir vous aider, conseiller et assister dans le choix d'un produit.

Se necessitar de informações adicionais ou mais detalhadas sobre algum produto, pode contactar-nos através do info@eurostil.com ou ligue +34 93 274 07 84, teremos o maior prazer em ajudá-lo e aconselhá-lo na melhor escolha de produtos.

Symboles · Icons



Unité minimumde vente
Unidade mínima de venda



Unités par boîte
Unidades por caixa



Prix échelonné
Preço escalado



Pointe fine
Ponta fina



Pointe plate
Ponta plana



Point de test
Ponto de teste



Pointe oblique
Pointe oblique



Poils en nylon
Cerdas de nylon



Poils en plastique
Cerdas de plástico



Pics de sanglier
Cerdas de javali



Poils de bois
Pua de madeira



Poils en métal
Pua de metal



Coiffure Spéciale

CABELEIREIRO ESPECIAL

Pollié 

lacla 

Ondina 

ETI 

PEGASUS 

Leriotti 
MADE IN ITALY

TRAMUNTANA 

MEDITERRÁNEO 

SILK  OMB 

BERGMANN
HAIR AND MORE...

MATADOR
PROFESIONAL

Valera 

REMINGTON 

01 Appareils électriques Aparelhos elétricos 8

Sèches-cheveux · Secadores	9
Diffuseurs · Difusores	22
Activateurs · Ativador	24
Casque sèche-cheveux, Vaporisateurs Cerotti Secadores de casco, Vaporizador Cerotti	25
Casque sèche-cheveux, Vaporisateurs Eurostil Secadores de casco, Vaporizador Eurostil	27
Casque sèche-cheveux VALERA · Capacete secador de cabelo VALERA ..	28
Fer à lisser professionnel · Prancha Profissional	29
Fers à friser · Ferro de frisar	39
Mélangeur Rechargeable · Misturador recarregável	45
Stérilisateur · Esterilizadores	46
Aspirateur à cheveux · Aspirador de pó	48
Nettoyant peignes et brosses	49
<i>Limpador de pentes e escovas</i>	

02 Articles de teinture Artigos de coloração 50

Accessoires teinture · Acessórios tinta	51
Bandes spéciales à mèches · Tiras especial madeixas	53
Minuteurs · Temporizadores	54
Balances · Balanças	55
Bols · Tigelas	56
Pinceaux à teinture · Trinchas tinta	60
Cuvette et nuque pour lave-tête	65
<i>Bacia e capas lava-cabeças</i>	
Shakers et mesureurs · Misturadores e capas	66
Papier aluminium · Papel alumínio	68
Protecteurs · Protetores	70
Gants · Luvas	71
Peignoir · Penteador	74
Capas · Capas	75
Tabliers · Aventais	88
Capas de coiffure pour enfants · Capas infantis	90
Vêtement LACLA · Vestuário LACLA	92

03 Cosmétique de cheveux Cosmético de cabelo 106

Teinte Bright colour · Corante Bright Colour	107
Oxydants OXY BRIGHT · Oxidante OXY BRIGHT	114
Colorant protecteur d'huile · Tintura de protetor de Óleo	116
Décolorante · Descolorante	118
Traitement IONIK · Tratamento IONIK-K	120
Shampooings et masques · Champôs e máscaras	123
Produits de finition et fibres capillaires	129
<i>Produtos de acabamento e fibras capilares</i>	

04 Clips et pinces à cheveux Clips & pinças 138

Clips · Clips	139
Épingles à cheveux et clips · Ganchos e clips	143
Pinces à cheveux · Pinças	150
Pinces à cheveux · Molas	156
Bande élastique de cheveux · Pulseiras elásticas recolhe cabelo ..	159
Turbans · Turbantes	163
Clips de perles · Clips de pérolas	164

05 Papier Papel 166

Couverture de table esthétiques et serviettes	167
<i>Capas marquesas e toalhas</i>	
Papier permanent · Papel permanente	168
Protecteurs cou · Protetores pescoço	169

06 Formation Formação 170

Têtes malléables cheveux naturels	171
<i>Cabeças manequim cabelo 100% natural</i>	
Têtes malléables cheveux synthétiques	176
<i>Cabeças manequim cabelo sintético</i>	
Têtes malléables BERGMANN	177
<i>Cabeças manequim BERGMANN</i>	
Supports/trépieds · Suportes/tripés	179

07 Mobilier Mobiliário 180

Compteurs et miroirs · Contadores e espelhos	181
Chaises pour enfants · Cadeiras para crianças	183
Tabourets · Bancos	185
Chaise · Assento	187
Laves-têtes · Rampa de lavagem	188
Chaises et fauteuils de coiffure	194
<i>Cadeiras e poltronas de cabeleireiro</i>	
Lavage de tête portable · Lavagem de cabeça portátil	200
Chariot · Carrinho	201
Divers · Vários	205

08 Peignes et brosses Escovas y pentes 206

Brosses à crêper · Escovas de crepar	207
Brosses spirales · Escovas espiral	208
Brosses circulaires avec manche en bois	209
<i>Escovas circular com punho de madeira</i>	
Brosses pneumatiques avec manche en bois	213
<i>Escova com fole e punho de madeira</i>	
Brosse pneumatiques pour démêler	217
<i>Escova com fole desembaraçar</i>	
Brosses pneumatiques avec manche en plastique	218
<i>Escova pneumática com punho de plástico</i>	
Brosses pneumatiques avec manche en caoutchouc	224
<i>Escova pneumática com punho de borracha</i>	
Brosse pour démêler · Escova desembaraçar	227
Présentoir brosses · Expositor escovas	228
Brosses araignée · Escovas esqueletos	232
Brosses plates démêler · Escovas planas desembaraçar	237
Peignes anti-poux et pour bébé · Pentes finos e por bebe	238
Brosses thermiques, ioniques, céramiques, chromatiques	240
<i>Escovas térmicas, iônicas, cerâmicas, cromáticas</i>	
Peignes prof. EUROSTIL · Pentes prof. EUROSTIL	246
Peignes carbone · Pentes carbono	258
Set de peignes · Set pentes	261
Peignes PEGASUS · Pentes PEGASUS	263
Peignes prof. POLLIÉ · Pentes prof. POLLIÉ	264
Peignes prof. MATADOR · Pentes prof. MATADOR	266
Peignes prof. SILKOMB · Pentes prof. SILKOMB	269
Peignes en couleur · Pentes cores	270
Pot peignes couleurs · Set pentes de cores	274
Peignes bois couleurs · Pentes cor madeira	279
Peignes creux · Pente dentes largo	281
Peignes écaille · Pente concha	283
Ligne de produits en matériaux recyclés	286
<i>Linea de productos de material reciclado</i>	

09**Bigoudis, crêpons à Chignon et bonnets**
Rolos, rodilhos e gorros**288**

Bigoudis en bois · <i>Bigudis de madeira</i>	289
Bigoudis en plastique · <i>Bigudis de plástico</i>	291
Papillotes · <i>Papillots</i>	293
Rulos · <i>Rollers</i>	294
Bonnet · <i>Redes</i>	302
Crêpons à chignon · <i>Rodilhas mono</i>	311

11**Extensions et postiches**
Extensões e madeixas**336**

Tissages cheveux naturels · <i>Madeixas cabelo</i>	337
Ameaux aluminium gravé · <i>Anéis de alumínio gravado</i>	338
Extensions avec clip · <i>Extensões com clipe</i>	339
Divers · <i>Vários</i>	340

10**Ciseaux**
Tesouras**315**

Ciseaux titanium / Ciseaux Décorées	317
<i>Tesouras titânio/Tesouras decoradas</i>	
Ciseaux professionnels Premium	324
<i>Premium Tesoura profissional</i>	
Ciseaux pour gauchers · <i>Tesouras especial canhotos</i>	325
Ciseaux professionnels · <i>Tesoura profissional</i>	327
Ciseaux initiation · <i>Tesoura iniciação</i>	329
Étui ciseaux · <i>Estojo tesouras</i>	330
Cheveux coupés et rasoirs	331
<i>Cortar cabelos e cavinetes</i>	

12**Divers**
Vários**342**

Coton · <i>Algodão</i>	343
Malettes · <i>Malas</i>	344
Porta-outils · <i>Porta-utensílios</i>	352
Facepro · <i>Facepro</i>	354
Divers · <i>Vários</i>	355
Porte-perruque · <i>Porta perucas</i>	356
Pulvérisateur · <i>Pulverizadores</i>	357
Serviette · <i>Toalha</i>	359
Articles d'hygiène · <i>Artigos higiene</i>	360

Les prix indiqués dans ce catalogue sont des prix recommandés, taxes en sus.
Les prix seront valables sauf erreurs typographiques.
Industrias Oriol 1942, S.L. se réserve le droit d'apporter des modifications sans préavis.

*Os preços listados neste catálogo são preços recomendados, impostos não incluídos.
Os preços serão válidos, exceto por erros tipográficos.
Industrias Oriol 1942, S.L. reserva-se o direito de fazer modificações sem aviso prévio.*

01

Appareils électriques

ARTIGOS
ELÉTRICOS

*Sèches-cheveux, activateurs, Casque
sèches-cheveux, fers à lisser, fers à friser...*

*Secadores, estimulador térmico,
capacete secador de cabelo, ferro frisar...*



Sèche-cheveux CALIMA
Secador CALIMA

NEW

REF. 07171/50

NEW

REF. 07171/70



18,6 cm



18,6 cm

- » Puissance: 2 300W
- » Moteur professionnel CA
- » Poids: 530 gr
- » Débit d'air: 98 m³/h
- » 2 vitesses · 3 températures
- » Bouton d'air froid
- » 2 embouts orientables 62 et 70 mm
- » Filtre amovible en acier inoxydable
- » Câble avec anneau pour suspension
- » Faible niveau sonore : 80 dB
- » Tension: 220-240V~
- » Fréquence: 50/60 Hz
- » Super compact
- » Ionique, céramique et tourmaline
- » Compatible avec le diffuseur 04346/50

- » Potência: 2300 W
- » Motor profissional AC
- » Peso: 530 gr
- » Caudal de ar 98 m³/h
- » 2 velocidades · 3 temperaturas
- » Botão de ar frio
- » 2 boquilhas orientáveis 62 e 70 mm
- » Filtro removível de aço inoxidável
- » Cabo com anel para pendurar
- » Baixo nível sonoro: 80 Db
- » Voltagem: 220-240V~
- » Frequência: 50/60 Hz
- » Super compacto
- » Iônico, cerâmica e turmalina
- » Compatível com difusor 04346/50

Sèche-cheveux modèle FURIOUS COMPACT PLUS eurostil
Secador modelo FURIOUS COMPACT PLUS eurostil



Les sècheurs Eurostil Furious et Furious Plus sont une gamme de sècheurs électriques de 2200 W idéale pour tout professionnel à la recherche d'un sècheur polyvalent qui répond aux attentes les plus exigeantes.

Os secadores Eurostil Furious e Furious Plus são uma variedade de secadores elétricos de 2200 W, ideais para qualquer profissional que procura um secador versátil que atenda às expectativas mais exigentes.

- » Puissance: 2200W
- » Moteur à courant alternatif (AC) compact de longue durée
- » Poids: 494 gr
- » Débit d'air: 84 m³/heure
- » 2 vitesses · 3 températures
- » Bouton d'air froid
- » 2 buses
- » Filtre amovible
- » Thermostat de sécurité
- » Câble avec anneau pour suspension
- » Tension: 220-240V~
- » Fréquence: 50/60 Hz
- » Finition lilas
- » Compatible avec les diffuseurs 04346/50 - 01147

- » Potência: 2200W
- » Motor compacto de longa duração (AC)
- » Peso: 494 gr
- » Fluxo de ar: 84 m³ / hora
- » 2 velocidades · 3 temperaturas
- » Botão de ar frio
- » 2 bicos
- » Filtro extraível
- » Termóstato de segurança
- » Cabo com anel para pendurar
- » Voltagem: 220-240V ~
- » Frequência: 50/60 Hz
- » Capa lilás
- » Compatível com difusores 04346/50 - 01147



REF. 06474



Sèche-cheveux eurostil modèle FURIOUS
Secador eurostil modelo FURIOUS



REF. 04922



- » Puissance: 2200W
- » Moteur à courant alternatif (AC) compact de longue durée
- » Poids: 590 g
- » Débit d'air: 74 m³/heure
- » 2 vitesses · 3 températures
- » Bouton d'air froid
- » 2 buses: 1 large, 1 étroite
- » Filtre amovible
- » Thermostat de sécurité
- » Câble avec anneau pour suspension
- » Tension: 220-240V~
- » Fréquence: 50 Hz.
- » Finition d'argent
- » Compatible avec les diffuseurs 04346/50 - 01147

- » Potência: 2200W
- » Motor compacto de longa duração (AC)
- » Peso: 590 gr
- » Fluxo de ar : 74 m³ / hora
- » 2 velocidades · 3 temperaturas
- » Botão de ar frio
- » 2 bicos: 1 largo, 1 estreito
- » Filtro extraível
- » Termóstato de segurança
- » Cabo com anel para pendurar
- » Voltagem 220-240V ~
- » Frequência: 50 Hz
- » Capa de prata
- » Compatível com difusores 04346/50 - 01147



22,6 cm



Sèche-cheveux eurostil modèle ZONDA**Secador eurostil modelo ZONDA**

Les sèche-cheveux Eurostil équipés de la technologie Triple (ionique, céramique et tourmaline) sont des outils indispensables pour les professionnels. Ils procurent hydratation, douceur et brillance, ils sèchent plus vite, ainsi qu'ils ont un effet bactéricide et réduisent le vieillissement de la fibre capillaire. Ils permettent de créer n'importe quel type de coiffure: pour cheveux lisses ou ondulés, volumineux etc.

Os secadores Eurostil equipados com TECNOLOGIA TRIPLA (iônica, cerâmica e turmalina) são ferramentas indispensáveis para profissionais. Hidratam o cabelo dando-lhe brilho e suavidade, secam mais rápido, têm efeito bactericida e reduzem o envelhecimento da fibra capilar. Permite criar todo o tipo de penteados: alisamento, ondulações, volume, etc.

REF. 04993/53

REF. 04993/70



23,6 cm



23,6 cm

- » Puissance: 2400W
- » Moteur à courant alternatif (AC) compact de longue durée
- » Poids: 590 gr
- » Débit d'air: 97 m³/heure
- » 2 vitesses · 3 températures
- » Bouton d'air froid
- » 2 buses réglables de 62mm et 70mm
- » Filtre amovible
- » Thermostat de sécurité
- » Câble souple de 3m avec anneau de suspension
- » Faible niveau sonore
- » Tension 220-240V~
- » Fréquence: 50/60 Hz
- » Filtre en acier inoxydable
- » Ionique, céramique et tourmaline
- » Compatible avec les diffuseurs : 04346/50 - 01147 - 03036/50

- » Potência: 2400W
- » Motor compacto de longa duração (AC)
- » Peso: 590 gr
- » Fluxo de ar : 97m³/hora
- » 2 velocidades · 3 temperaturas
- » Botão de ar frio
- » 2 bicos direcionáveis de 62mm e de 70mm
- » Filtro extraível
- » Termóstato de segurança
- » Cabo flexível de 3m com anel para pendurar
- » Silencioso
- » Voltagem 220-240V ~
- » Frequência: 50/60 Hz
- » Filtro: aço Inox
- » Iônico, cerâmica e turmalina
- » Compatível com difusores: 04346/50 - 01147 - 03036/50

Sèche-cheveux eurostil modèle WIND

Secador eurostil modelo WIND



Les sèche-cheveux Eurostil équipés de la technologie Triple (ionique, céramique et tourmaline) sont des outils indispensables pour les professionnels. Ils procurent hydratation, douceur et brillance, ils séchent plus vite, ainsi qu'ils ont un effet bactéricide et réduisent le vieillissement de la fibre capillaire. Ils permettent de créer n'importe quel type de coiffure : pour cheveux lisses ou ondulés, volumineux etc.

Os secadores Eurostil equipados com TECNOLOGIA TRIPLA (iônica, cerâmica e turmalina) são ferramentas indispensáveis para profissionais. Hidratam o cabelo dando-lhe brilho e suavidade, secam mais rápido, têm efeito bactericida e reduzem o envelhecimento da fibra capilar. Permite criar todo o tipo de penteados: alisamento, ondulações, volume, etc



- » Puissance: 2300W
- » Moteur à courant alternatif (AC) compact de longue durée
- » Poids: 530 gr
- » Débit d'air: 88 m³/heure
- » 2 vitesses · 3 températures
- » Bouton d'air froid
- » 2 buses réglables de 62mm et 70mm
- » Filtre amovible
- » Thermostat de sécurité
- » Câble souple de 3m avec anneau de suspension
- » Faible niveau sonore
- » Tension 220-240V~
- » Fréquence: 50/60 Hz.
- » Avec indicateur de température
- » Filtre en acier inoxydable
- » Compatible avec les diffuseurs : 04346/50 - 01147 - 03036/50

- » Potência: 2300W
- » AC long-life compact motor
- » Weight: 530 gr
- » Fluxo de ar : 88m³/hora
- » 2 velocidades · 3 temperaturas
- » Botão de ar frio
- » 2 bicos direcionáveis de 62mm e de 70mm
- » Filtro extraível
- » Termóstato de segurança
- » Cabo extraflexível de 3m com anel para pendurar
- » Silencioso
- » Voltagem 220-240V ~
- » Frequência: 50/60 Hz
- » Com luz indicadora de temperatura
- » Filtro Aço Inox
- » Compatível com difusores: 04346/50 - 01147 - 03036/50



Sèche-cheveux COMPACT PROFESSIONNEL

Secador COMPACT PROFESSIONAL



Le sèche-cheveux compact professionnel a un design attrayant, ergonomique et léger. Disponible en noir et en blanc ainsi qu'il est doté d'une finition en caoutchouc colorée pour l'empêcher de glisser. Moteur puissant avec générateur d'ions. Comprend deux buses de tailles différentes.

O Secador Compact Professional tem um design atrativo, ergonómico e leve. Disponível em branco, preto e branco com borrachas coloridas. Motor potente, com gerador de iões. Inclui dois bicos de diferentes dimensões.

NEW



REF. 04202

21,5 cm

- » Puissance: 2000W
- » Moteur à courant alternatif (AC) compact de longue durée
- » Poids: 580 gr
- » Débit d'air: 90 m³/heure
- » 2 vitesses · 3 températures
- » Bouton d'air froid
- » 2 buses réglables de 62mm et 70mm
- » Filtre amovible
- » Thermostat de sécurité
- » Câble souple de 3m avec anneau de suspension
- » Faible niveau sonore
- » Tension 220-240V~
- » Fréquence: 50/60 Hz
- » Design ergonomique
- » Boîtier robuste et léger en polyamide
- » Finition en caoutchouc antidérapant
- » Moteur générateur d'ions
- » Compatible avec les diffuseurs : 04346/50 - 01147 - 03036/50

- » Potência: 2000W
- » Motor compacto de longa duração (AC)
- » Peso: 580 gr
- » Fluxo de ar: 90 m³/hora
- » 2 velocidades · 3 temperaturas
- » Botão de ar frio
- » 2 bicos direcionáveis de 62mm e de 70mm
- » Filtro extraível
- » Termóstato de segurança
- » Cabo flexível de 3m com anel para pendurar
- » Silencioso
- » Voltagem 220-240V~
- » Frequência: 50/60 Hz
- » Design ergonómico
- » Exterior robusto e leve em Poliamida
- » Capa de borracha antiderrapante
- » Motor gerador de iões
- » Compatível com difusores: 04346/50 - 01147 - 03036/50



REF. 04202/58/99

Sèche-cheveux COMPACT ULTRA LIGHT

Secador COMPACT EXTRA LIGHT



Le sèche-cheveux compact professionnel a un design attrayant, ergonomique et léger. Disponible en noir et en blanc. Doté d'une finition en caoutchouc colorée pour l'empêcher de glisser. Moteur puissant avec générateur d'ions. Comprend deux buses de tailles différentes.

O Secador Compact Professional tem um design atrativo, ergonômico e leve. Disponível em branco, preto e branco com borrachas coloridas. Motor potente, com gerador de iões. Inclui dois bicos de diferentes dimensões.



REF. 04203

21,5 cm



REF. 04203/58

21,5 cm



- » Puissance: 1800W
- » Moteur à courant alternatif (DC) compact de longue durée
- » Poids: 430 gr
- » Débit d'air: 76 m³/heure
- » 2 vitesses · 3 températures
- » Bouton d'air froid
- » 2 buses réglables de 62mm et 70mm
- » Filtre amovible
- » Thermostat de sécurité
- » Câble souple de 3m avec anneau de suspension
- » Faible niveau sonore
- » Tension 220-240V~
- » Fréquence: 50/60 Hz
- » Compact et PLUS LÉGER
- » Finition en caoutchouc antidérapant
- » Moteur générateur d'ions
- » Compatible avec les diffuseurs : 04346/50 - 01147 - 03036/50

- » Potência: 1800W
- » Motor compacto de longa duração (DC)
- » Peso: 430 gr
- » Fluxo de ar: 76 m³/hora
- » 2 velocidades · 3 temperaturas
- » Botão de ar frio
- » 2 bicos direcionáveis de 62mm e de 70mm
- » Filtro extraível
- » Termostato de segurança
- » Cabo extraflexível de 3m com anel para pendurar
- » Silencioso
- » Voltagem 220-240V~
- » Frequência: 50/60 Hz
- » Compacto e MAIS LEVE
- » Capa de borracha antiderrapante
- » Motor gerador de iões
- » Compatível com difusores: 04346/50 - 01147 - 03036/50



REF. 04203/58/99

Sèche-cheveux NEO3800

Secador NEO3800

NEO3800
PROFESIONAL



REF. 03323

- » Puissance: 2000W
- » Moteur à courant alternatif (AC) compact de longue durée
- » Poids: 590 gr
- » Débit d'air: 84 m³/heure
- » 2 vitesses · 3 températures
- » Bouton d'air froid
- » 2 buses réglables de 63 mm et 72 mm
- » Filtre amovible
- » Thermostat de sécurité
- » Câble souple de 3m avec anneau de suspension
- » Tension 220-240V~
- » Fréquence: 50/60 Hz
- » Protection thermique
- » Compatible avec les diffuseurs: 04346/50 - 01147 - 03036/50

- » Potência: 2000W
- » Motor compacto de longa duração (AC)
- » Peso: 590 gr
- » Fluxo de ar: 84 m³/hora
- » 2 velocidades · 3 temperaturas
- » Botão de ar frio
- » 2 bicos direcionáveis de 63 mm e de 72 mm
- » Filtro extraível
- » Termóstato de segurança
- » Cabo extraflexível de 3m com anel para pendurar
- » Voltagem 220-240V~
- » Frequência: 50/60 Hz
- » Proteção térmica
- » Compatível com difusores: 04346/50 - 01147 - 03036/50



Sèche-cheveux NEO3830

Secador NEO3830

ionic NEO3830
PROFESIONAL



REF. 03904

- » Puissance: 2000W
- » Moteur à courant alternatif (AC) compact de longue durée
- » Poids: 590 gr
- » Débit d'air: 82 m³/heure
- » 2 vitesses · 3 températures
- » Bouton d'air froid
- » 2 buses réglables de 62mm et 70mm
- » Filtre amovible
- » Thermostat de sécurité
- » Câble souple de 3m avec anneau de suspension
- » Tension 220-240V~
- » Fréquence: 50/60 Hz
- » Tourmaline /ionique
- » Protection thermique
- » Compatible avec les diffuseurs: 04346/50 - 01147 - 03036/50

- » Potência: 2000W
- » Motor compacto de longa duração (AC)
- » Peso: 590 gr
- » Fluxo de ar: 82 m³/hora
- » 2 velocidades · 3 temperaturas
- » Botão de ar frio
- » 2 bicos direcionáveis de 62mm e de 70mm
- » Filtro extraível
- » Termóstato de segurança
- » Cabo extraflexível de 3m com anel para pendurar
- » Voltagem 220-240V~
- » Frequência: 50/60 Hz
- » Com turmalina e função iônica
- » Proteção térmica
- » Compatível com difusores: 04346/50 - 01147 - 03036/50

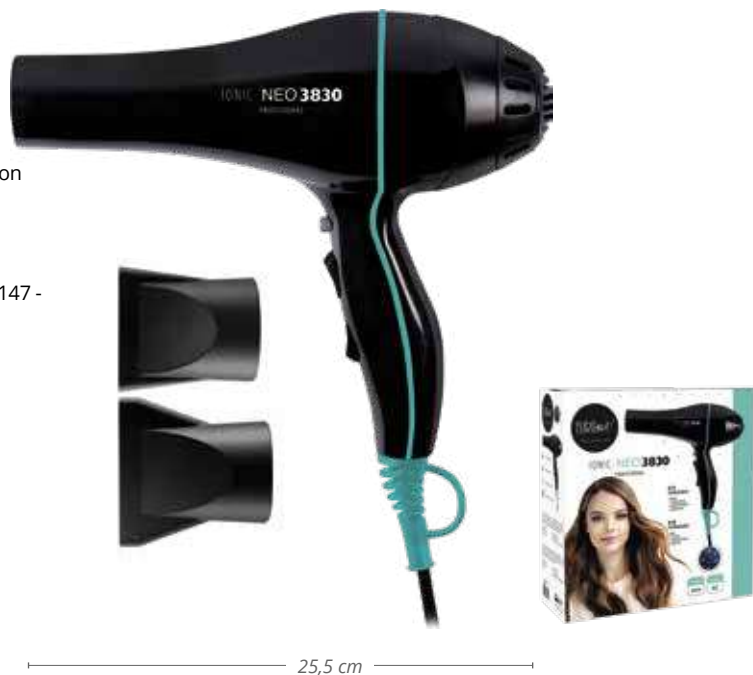

Sèche-cheveux NEO 3820**Secador NEO 3820****ionic NEO 3820**
PROFESIONAL1
u.m.vta12
box

REF. 03905

- » Puissance: 2000W
- » Moteur à courant alternatif (AC) compact de longue durée
- » Poids: 585 gr
- » Débit d'air: 79 m³/heure
- » 2 vitesses 3 températures
- » Bouton d'air froid
- » 2 buses: 1 large, 1 étroite
- » Filtre amovible
- » Thermostat de sécurité
- » Câble souple de 3m avec anneau de suspension
- » Tension 220-240V~
- » Fréquence: 50/60 Hz
- » Tourmaline /ionique
- » 1 diffuseur

- » Potência: 2000W
- » Motor compacto de longa duração (AC)
- » Peso: 585 gr
- » Fluxo de ar: 79 m³/hour
- » 2 velocidades · 3 temperaturas
- » Botão de ar frio
- » 2 bicos: 1 largo, 1 estreito
- » Filtro extraível
- » Termóstato de segurança
- » Cabo extra flexível de 3 m
- » Voltagem: 220-240V ~
- » Frequência: 50/60 Hz
- » Com turmalina e função iônica.
- » 1 difusor

**Sèche-cheveux NEO 3840****Secador NEO 3840****ionic NEO 3840**
PROFESIONAL1
u.m.vta12
box

REF. 04363

- » Puissance: 2200W
- » Moteur à courant alternatif (AC) compact de longue durée
- » Poids: 590 gr
- » Débit d'air: 83 m³/heure
- » 2 vitesses · 3 températures
- » Bouton d'air froid
- » 2 buses réglables: 1 large, 1 étroite
- » Filtre amovible
- » Thermostat de sécurité
- » Câble souple de 3m avec anneau de suspension
- » Tension 220-240V~
- » Fréquence: 50/60 Hz
- » Conception ergonomique
- » Boîtier robuste et léger en polyamide.
- » Tourmaline /ionique
- » Compatible avec les diffuseurs: 04346/50 - 01147 - 03036/50

- » Potência: 2200W
- » Motor compacto de longa duração (AC)
- » Peso: 590 gr
- » Fluxo de ar: 83 m³ / hour
- » 2 velocidades · 3 temperaturas
- » Botão de ar frio
- » 2 bicos ajustáveis: 1 largo, 1 estreito
- » Filtro extraível
- » Termóstato de segurança
- » Cabo extra flexível de 3 m
- » Voltagem 220-240V ~
- » Frequência: 50/60 Hz
- » Design ergonómico
- » Exterior robusto e leve em Poliamida
- » Com turmalina e função iônica
- » Compatível com difusores: 04346/50 - 01147 - 03036/50



Sèche-cheveux TRAMUNTANA

Secador TRAMUNTANA

TRAMUNTANA   1 u.m.vta  6 box

Le sèche-cheveux Tramuntana a un design attrayant, ergonomique et léger. Disponible en noir et 4 couleurs très actuelles et fraîches. Comprend deux buses de différentes tailles et un diffuseur pour les cheveux bouclés.

O secador de cabelo Tramuntana tem um design atraente, ergonômico e leve. Disponível em preto e mais cores. Inclui dois bicos de diferentes tamanhos e um difusor para cabelos cacheados.



REF. 04264/50

18,2 cm



INCLUS · INCLUI



REF. 04264/62



REF. 04264/64



REF. 04264/68



REF. 04264/75

- » Puissance: 2000W
- » Moteur à courant alternatif (AC) compact de longue durée
- » Poids: 500 gr
- » Débit d'air : 70 m³/heure
- » 2 vitesses · 3 températures
- » Bouton d'air froid
- » 2 buses: 1 large, 1 étroite
- » Filtre amovible
- » Thermostat de sécurité
- » Câble 3m avec anneau pour suspension
- » Tension 220-240V~
- » Fréquence: 50/60 Hz
- » Boutons latéraux
- » 1 diffuseur
- » Compatible avec le diffuseur 04346/50

- » Potência: 2000W
- » Motor compacto de longa duração (AC)
- » Peso: 500 gr
- » Fluxo de ar: 70 m³/hora
- » 2 velocidades · 3 temperaturas
- » Botão de ar frio
- » 2 bicos: 1 largo, 1 estreito
- » Filtro extraível
- » Termóstato de segurança
- » Cabo 3m com anel para pendurar
- » Voltagem 220-240V~
- » Frequência: 50/60 Hz
- » Botões laterais
- » 1 difusor
- » Compatível com difusor 04346/50

Sèche-cheveux MEDITERRÁNEO

Secador MEDITERRÁNEO

MEDITERRÁNEO



Le sèche-cheveux Méditerranéo a un design attrayant, ergonomique et léger. Disponible en noir et 4 couleurs très actuelles et fraîches. Comprend deux buses de différentes tailles et un diffuseur pour les cheveux bouclés.

O secador de cabelo Mediterráneo tem um design atraente, ergonômico e leve. Disponível em preto e mais cores. Inclui dois bicos de diferentes tamanhos e um difusor para cabelos cacheados.



REF. 04263/50

INCLUS · INCLUI



18,2 cm



REF. 04263/62



REF. 04263/64



REF. 04263/68



REF. 04263/75

- » Puissance 2000W
- » Moteur à courant alternatif (AC) compact de longue durée
- » Poids: 500 gr
- » Débit d'air: 70 m³/heure
- » 2 vitesses · 3 températures
- » Bouton d'air froid
- » 2 buses: 1 large, 1 étroite
- » Filtre amovible
- » Thermostat de sécurité
- » Câble avec anneau pour suspension
- » Tension 220-240V~
- » Fréquence: 50/60 Hz
- » 1 diffuseur

- » Potência: 2000W
- » Motor compacto de longa duração (AC)
- » Peso: 500 gr
- » Fluxo de ar : 70 m³/hora
- » 2 velocidades · 3 temperaturas
- » Botão de ar frio
- » 2 bicos: 1 largo, 1 estreito
- » Filtro extraível
- » Termóstato de segurança
- » Cabo com anel para pendurar
- » Voltagem 220-240V ~
- » Frequência: 50/60 Hz
- » 1 difusor

Sèche-cheveux IL FUTURO Secador IL FUTURO

1
u.m.vta

12
box

- » Puissance: 2150W
- » Moteur à courant alternatif (AC) compact de longue durée
- » Poids: 595 gr
- » Débit d'air: : 70 m³/heure
- » 2 vitesses · 3 températures
- » Bouton d'air froid
- » 2 buses
- » Filtre amovible
- » Thermostat de sécurité
- » Câble 3m avec anneau pour suspension
- » Tension 220-240V~
- » Fréquence: 50/60 Hz.
- » Nouveau système d'émission d'ions négatifs pour éliminer l'électricité statique des cheveux
- » Manche traditionnelle et latérale
- » Pliable
- » Ionique
- » Compatible avec les diffuseurs: 04346/50 - 01147

- » Potência: 2150W
- » Motor compacto de longa duração (AC)
- » Peso: 595 gr
- » Fluxo de ar : 70 m³/hora
- » 2 velocidades · 3 temperaturas
- » Botão de ar frio
- » 2 bicos
- » Filtro extraível
- » Termóstato de segurança
- » Cabo 3m com anel para pendurar
- » Voltagem 220-240V ~
- » Frequência: 50/60 Hz
- » Novo sistema de emissão de iões negativos para eliminar a eletricidade estática do cabelo
- » Aperto tradicional e lateral
- » Drobrável
- » ionic
- » Compatível com difusores: 04346/50 - 01147



REF.03051

PLIABLE / FOLHABLE



22 cm

Sèche-cheveux ETI TURBO STRATOS 3800 Secador TURBO ESTRATOS 3800 ETI



1
u.m.vta

12
box

- » Puissance: 2400W
- » Moteur à courant alternatif (AC) compact de longue durée
- » Poids: 590 gr
- » Débit d'air: 99 m³/heure
- » 2 vitesses · 3 températures
- » Bouton d'air froid
- » 2 buses: 1 large, 1 étroite
- » Filtre amovible
- » Thermostat de sécurité
- » Câble avec anneau pour suspension
- » Niveau sonore 69 dB
- » Tension 220-240V~
- » Fréquence: 50/60 Hz
- » Compatible avec les diffuseurs: 04346/50 - 01147 - 03036/50

- » Potência: 2400W
- » Motor compacto de longa duração (AC)
- » Peso: 590 gr
- » Fluxo de ar : 99 m³/hora
- » 2 velocidades · 3 temperaturas
- » Botão de ar frio
- » 2 bicos: 1 largo, 1 estreito
- » Filtro extraível
- » Termóstato de segurança
- » Cabo com anel para pendurar
- » Nível sonoro: 69 dB
- » Voltagem 220-240V ~
- » Frequência: 50/60 Hz
- » Compatível com difusores: 04346/50 - 01147 - 03036/50



REF.02931

24 cm

Sèche-cheveux ETI NANO STRATOS 3700 Secador ETI NANO STRATOS 3700



1
u.m.vta

12
box

- » Puissance: 2200W
- » Moteur à courant alternatif (AC) compact de longue durée
- » Poids: 575 gr
- » Débit d'air: 100 m³/heure
- » 2 vitesses · 3 températures
- » Bouton d'air froid
- » 2 buses
- » Filtre amovible
- » Thermostat de sécurité
- » Câble avec anneau pour suspension
- » Faible niveau sonore
- » Tension 220-240V~
- » Fréquence: 50/60 Hz.
- » Excellente technologie
- » Compatible avec les diffuseurs: 04346/50 - 01147 - 03036/50

- » Potência: 2200W
- » Motor compacto de longa duração (AC)
- » Peso: 575 gr
- » Fluxo de ar : 100 m³/hora
- » 2 velocidades · 3 temperaturas
- » Botão de ar frio
- » 2 bicos
- » Filtro extraível
- » Termóstato de segurança
- » Cabo com anel para pendurar
- » Baixo nível sonoro
- » Voltagem 220-240V ~
- » Frequência: 50/60 Hz
- » Tecnologia excelente
- » Compatível com difusores: 04346/50 - 01147 - 03036/50



REF. 03003/50

19,8 cm

Support de sèche-cheveux Suporte secador



REF.04431



85 cm

Support de sèche-cheveux en métal, adapté aux sècheurs à grande ouverture. Facile à manipuler et à déplacer, confortable pour sa stabilité. Design élégant et moderne.

Porta secador de pé metálico, apto para secadores de boca grande. Fácil de manejar e trasladar, cómodo pela sua estabilidade. Design elegante e moderno.

Porte-sèche cheveux mural métallique Porta secador parede metálico



REF.07275

- » Matière: aluminium
- » Avec cache en caoutchouc

- » Material: alumínio
- » Com embelezador de borracha



NEW



Support de séchoir adaptable Porta secador adaptável



REF. 00672



- » Métal
- » Metálico



REF. 02830



Diffuseur universel Difusor universal



Diffuseur noir
Difusor preto



REF. 01147

Diffuseur de couleurs
Difusores coloridos



REF. 01147/99



Diffuseur noir
Difusor preto



REF. 03036/50

Diffuseur de couleurs
Difusores coloridos



REF. 03036/99

Diffuseurs pliants en SILICONE

Difusores dobráveis de SILICONE

1
u.m.vta

8
box

- » Distribue la chaleur uniformément
- » Conception spéciale, léger, pliable et ne prend pas de place
- » Universel, s'adapte à la plupart des sèche-cheveux
- » Réf 04346: Max. 12,9 cm min. 6,8 cm
- » Réf 04346: Ø 6,3 cm - Ø 13,9 cm

- » Reparte o calor de forma homogênea
- » Design especial, leve, dobrável e não ocupa espaço
- » Universal, adapta-se à maioria dos secadores
- » Ref. 04346: Altura máx. 12,9 cm mín. 6,8 cm
- » Ref. 04346: Ø 6,3 cm - Ø 13,9 cm



REF. 04346/62



REF. 04346/68



REF. 04346/64



REF. 04346/50

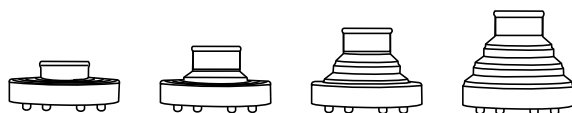

Diffuseur éponge

Difusor esponja

1
u.m.vta

12
box

Idéal pour fournir de la chaleur aux travaux de mèches, coloration, permanentes et traitements capillaires.

Idéal para fornecer calor para trabalhos de mechas, coloração, permanentes e tratamentos capilares.



REF. 02371

Casque thermo-activateur de couleur noir

Ativador térmico preto



- » Puissance: 900W
- » Thermostimulateur de dernière génération
- » Compact, occupe peu d'espace
- » Agit par la chaleur pour que la coloration pénètre en peu de temps
- » Avec minuterie, régulateur électronique de rayonnement de l'énergie
- » 5 commutateurs individuels pour allumer chacune des lampes
- » Type de résistance: infrarouge
- » Température maximale 40°C
- » Fréquence: 50 Hz
- » Tension 220-240V~

- » *Potência: 900W*
- » *Termo estimulador de última geração*
- » *Compacto, ocupa pouco espaço.*
- » *Atua através de calor para que a coloração penetre em pouco tempo*
- » *Com temporizador, regulador eletrônico da radiação de energia*
- » *5 interruptores individuais para acender*
- » *cada uma das lâmpadas*
- » *Tipo de resistência: infravermelhos*
- » *Temperatura máxima 40°C*
- » *Frequência: 50 Hz*
- » *Voltagem 220-240V ~*

Support
Suporte

REF.03007

Support mural
Suporte de parede

REF.03008

Casque thermo-activateur de couleur blanc

Ativador térmico branco



- » Puissance: 1400W
- » Thermostimulateur compact de dernière génération
- » Doté d'une ventilation
- » Avec minuterie, régulateur électronique de rayonnement d'énergie
- » Écran numérique
- » Tension: 220-240V~
- » Matériel: nylon
- » Type de résistance: infrarouge
- » 3 vitesses

- » *Potência: 1400W*
- » *Termo estimulador compacto de última geração.*
- » *Dispõe de ventilação.*
- » *Com temporizador, regulador eletrônico da radiação da energia*
- » *Display digital*
- » *Voltagem: 220-240V~*
- » *Material: nylon*
- » *Tipo de resistência: infravermelhos*
- » *3 velocidades*

Support
Suporte

REF.04273

Support mural
Suporte de parede

REF.04274

Activateur électronique noir

Ativador eletrônico preto



Thermo stimulateur compact pour coiffeurs au design innovant qui offre au client un confort maximum.

NEW

Caractéristiques:

- » Minuterie
- » Réglage électronique de la radiation d'énergie
- » 5 interrupteurs individuels pour allumer et éteindre chaque lampe circulaire.

Termo estimulador compacto para cabeleireiros com um design inovador que oferece o máximo conforto para o cliente.

Características:

- » *Temporizador*
- » *Regulação eletrônica da radiação de energia*
- » *5 interruptores individuais para ligar e desligar cada lâmpada circular*

Avec pied
Com pé

REF.07433

Support mural
Suporte parede

REF.07434

Casque sèche-cheveux ATOMIC TURBO

Secador de casco turbo ATOMIC TURBO



Casque sèche-cheveux professionnel avec minuterie, thermostat, voyant de température et sélecteur de vitesse.

- » Design rétro-futuriste avec visière intégrée
- » Puissance supérieure - 1 400 W ULTRA POWER
- » Cloche avec direction du flux d'air

Configuration:

- » Automatique / 1 vitesse
- » 4 vitesses TURBO

Capacete secador de cabelo profissional com temporizador, termostato, luz de controlo de temperatura e seletor de velocidade.

- » Design retro-futurista com viseira integrada
- » Maior potência - 1400W ULTRA POWER
- » Capacete com direção do fluxo de ar

Configurações:

- » Automático / 1 velocidade
- » 4 velocidades TURBO



Support
Suporte

REF.07436



Casque sèche-cheveux turbo GONG

Secador de casco turbo GONG



- » Fréquence: 50 Hz
- » Puissance: 1400W
- » Vitesses TURBO avec minuterie, thermostat de régulation et témoin de contrôle Moteur à 4 vitesses de 600 tours par minute
- » Vitesse 1: services techniques de coiffure et de séchage libre et sans filets
- » Vitesse 2: services techniques de coiffure et de séchage normal
- » Vitesse 3: séchage rapide
- » Vitesse 4: séchage ultra-rapide grâce au grand débit d'air uniforme

- » Frequência: 50 Hz
- » Potência: 1400W
- » Velocidades TURBO com temporizador, termostato de regulação e indicador de controlo. Motor de 4 velocidades a partir de 600 revoluções por minuto
- » Velocidade 1: serviços técnicos de penteado e secagem livre e sem rede
- » Velocidade 2: serviços técnicos de penteado e secagem normal
- » Velocidade 3: secagem rápida
- » Velocidade 4: secagem ultrarrápida graças ao grande caudal de ar uniforme



1 vitesse
1 velocidade

1 vitesse
1 velocidade

REF. 03005/50

REF. 03005/58

- » Design moderne et ergonomique.
- » Système «monofork» qui prévient les problèmes de casser la charnière
- » Séchoir. Séchage très rapide en raison du grand débit d'air distribué
- » Uniformément
- » Diamètre mesuré entrée 28 cm
- » Diamètre de mesure maximum intérieur 39 cm

- » Projeto moderno e ergonômico.
- » Sistema "monofork" que evita problemas de quebrar a dobradiça
- » Secador. Secagem muito rápida pelo grande fluxo de ar distribuído
- » Uniformemente
- » Diâmetro medido de entrada 28 cm
- » Diâmetro de medida máxima interno 39 cm

Casque sèche-cheveux Ceriotti GONG
Capacete secador de cabelo GONG



- » Puissance 1400W
- » Vitesse 1
- » Design moderne et ergonomique
- » Sécheur très rapide grâce au grand volume d'air distribué uniformément
- » Hauteur de 210 cm pour placer le bras sur le mur

- » Potência 1400W
- » 1 velocidade
- » Design moderno e ergonômico
- » O secador é muito forte devido ao grande volume de ar distribuído uniformemente
- » Altura de 210 cm para colocar o braço na parede



Support mural
Suporte de parede

REF. 03006

REF. 03006/58

Casque sèche-cheveux HOT WIND automatique
Capacete secador de cabelo HOT WIND



- » Puissance: 1000W
- » Tension: 220-240V ~
- » Fréquence: 50 / 60Hz
- » 1 vitesse
- » Moteur 1300 tr / min
- » Matériel: Acier
- » Matériau du casque: ABS

- » Potência: 1000Wç
- » Voltagem: 220-240 V ~
- » Frequência: 50 / 60Hz
- » 1 velocidade
- » Motor de 1300 rpm
- » Material: Aço
- » Material do Capacete: ABS



Support
Suporte

REF. 04272/50

Casque vaporisateur sur pied de la marque Ceriotti
Vaporizador Ceriotti com suporte



Fuchsia
Fúcsia



REF.04275/68

Argent
Prata



REF.04275/54

- » Puissance: 1000W
- » Ce casque vaporisateur est un vrai petit bijou de technologie au service de la coiffure, il est réglable et fabriqué en polycarbonate
- » Sans OZONE

- » Potência: 1000W
- » Campânula com visor ajustável em nylon, policarbonato e aço.
- » Sem OZONE

Casque vaporisateur sur pied GEYSER OZONO
Vaporizador Ceriotti GEYSER OZONO com suporte



Vaporisateur professionnel pour traitements esthétiques et curatifs. En générant de la vapeur, Geysler favorise l'absorption des produits capillaires dans les cuticules, réduisant ainsi considérablement les temps d'exposition. La lampe d'ozone (sur les modèles adaptés) produit un effet stérilisant qui peut aider à améliorer la santé des cheveux et de la peau.

Vaporizador profissional para tratamentos de estética e curativos. A gerar vapor, Geysler favorece a absorção dos produtos capilares nas cutículas, reduzindo consideravelmente os tempos de exposição. A lâmpada de ozono (nos modelos adaptados) produz um efeito esterilizante que pode ajudar a melhorar a saúde do cabelo e da pele.

- » Minuterie
- » Régulateur électronique de température et de quantité de vapeur
- » Voyant de fonctionnement
- » Réservoir de condensat
- » Lampe d'ozone

- » Temporizador
- » Regulador eletrônico de temperatura e quantidade de vapor
- » Indicador de funcionamento
- » Tanque de condensação
- » Lâmpada de ozono



NEW

REF.07435

Casque sèche-cheveux ORLA
Secador de casco ORLA

- » Puissance: 1175W
- » Tension: 220-240V~
- » Fréquence: 50/60Hz
- » 5 vitesses
- » Minuterie 60 minutes maximum
- » Température maximale de 70°C
- » L'appareil est doté d'un dispositif de sécurité qui est automatiquement activé en cas de dysfonctionnement de l'appareil

- » Potência : 1175W
- » Voltagem: 220-240W~
- » Frequência: 50 / 60Hz
- » 5 velocidades
- » Temporizador 60 minutos máximo
- » Temperatura 70°C máximo
- » O equipamento conta com um dispositivo de segurança que se ativa automaticamente em caso de mau funcionamento do aparelho

Support mural
Suporte de parede

REF.03314

Mesure interne
Medição interna

33 cm

Support
Suporte

REF.03313

24 cm
Taille d'entrée maximale
*Tamanho máximo de entrada***Casque vaporisateur Eurostil**
Vaporizador Eurostil

- » Puissance: 400W
- » Système de préchauffage.
- » Led indiquant l'allumage
- » LED lumineuse et acoustique, indiquant le manque de l'eau dans le vaporisateur
- » Générateur d'ozone
- » Minuterie
- » Réservoir interne pour la condensation de l'eau (réalisation de vapeur) avec soupape de décharge et système pour tout retour
- » Uniquement l'eau distillée peut être utilisée

- » Potência: 400w
- » Sistema de pré-aquecimento
- » Led indicativo de ligado
- » Led luminoso e acústico, indicativo de falta de água no vaporizador
- » Gerador de ozono
- » Temporizador
- » Tanque interior para a condensação da água (realização de vapor) com válvula de alívio e sistema para qualquer retorno
- » Só pode ser utilizada água destilada

Support
Suporte

REF.03315

Support mural
Suporte de parede

REF.03316

Casque sèche-cheveux VALERA
Capacete secador de cabelo VALERA



- » Puissance 600W
- » Câble de 3 m
- » Casque Sèche-cheveux avec ionisateur confortable et ergonomique
- » 2 vitesses et 3 températures
- » Interrupteur d'air froid
- » Ultra-léger, silencieux et doux
- » Sac de voyage pratique inclus
- » Fréquence: 50/60 Hz

- » *Potência 600W*
- » *Cabo de 3 m*
- » *Cômodo e ergonômico*
- » *2 velocidades e 3 níveis de temperatura*
- » *Interruptor de ar frio*
- » *Ultra leve, silencioso e de toque suave*
- » *Bolsa prática de viagem incluída*
- » *Frequência: 50/60 Hz*

Casque Sèche-cheveux avec ionisateur de modèle VALERA . Confort ionique.

Com ionizador VALERA mod. Ionic Confort.



REF. 04615

Bigoudis chauffants
Rolos quentes

REMINGTON 



- » Puissance: 300W
- » 20 rouleaux recouverts de velours souple et remplis de cire pour obtenir un glissement doux et une chaleur durable
- » lons pour cheveux effrayés
- » 3 tailles: 4 petit (20 mm), 10 moyen (23 mm) et 6 grand (27 mm)
- » Pilote indicateur de puissance
- » Témoin lumineux qui change de couleur lorsque les rouleaux sont prêts à porter rouleaux avec extrémités froides pour un style facile
- » 20 fourches et clips de serrage colorés selon le type de rouleau

- » *Potência: 300W*
- » *20 rolos cobertos em soft velvet e cheios com cera para obter um slide suave e calor duradouro*
- » *lons para cabelo assustador*
- » *3 tamanhos: 4 pequenos (20 mm), 10 médios (23 mm) e 6 grandes (27 mm)*
- » *Piloto do indicador de potência*
- » *Luz indicadora que altera a cor quando os rolos estão prontos para usar rolos com extremidades frias para um estilo fácil*
- » *20 forquilhas coloridas e clips de fixação de acordo com o tipo de rolo*

REF. 06241



Fer à lisser EASY

Prancha EASY



Plaques en Céramique avec Tourmaline qui protègent les cheveux tout en leur apportant brillance et douceur, grâce à sa charge ionique, il évite que les cheveux ne deviennent électriques et qu'ils ne fassent des frisottis, la technologie Nano Silver (élimine les bactéries). Fonction auto-déconnexion : l'appareil se déconnecte automatiquement s'il n'est pas utilisé pendant 60 minutes.

Placas de Cerâmica com Turmalina que cuidam do cabelo proporcionando brilho e suavidade, mediante o seu carregamento iônico previne a eletrização dos cabelos e que estes fiquem encrespados, a tecnologia Nano Silver (elimina as bactérias). Função de auto desconexão: o aparelho desliga-se de forma automática, caso não seja utilizado passados cerca de 60 minutos.

- » Température: entre 130°C et 230°C
- » Puissance: 44W
- » Thermostat de sécurité
- » Indicateurs de câble: câble de 2,7 m avec rotation à 360°

- » Temperatura: entre 130°C and 230°C
- » Potência: 44W
- » Termóstato de segurança
- » Cabos: 2,7 m com rotação 360°



REF. 06332/68

REF. 06332/70

Fer à lisser INFRA-ROUGE céramique et tourmaline Plaques

Prancha INFRAVERMELHOS cerâmica e turmalina



Plaques en Céramique avec Tourmaline qui protègent les cheveux tout en leur apportant brillance et douceur, grâce à sa charge ionique, il évite que les cheveux ne deviennent électriques et qu'ils ne fassent des frisottis, la technologie Nano Silver (élimine les bactéries). Fonction auto-déconnexion : l'appareil se déconnecte automatiquement s'il n'est pas utilisé pendant 60 minutes. Lumière infra-rouge qui désintoxique et désinfecte les cheveux, tout en réduisant l'agression de la chaleur des plaques. Ses principales propriétés sont l'amélioration de la circulation et la stimulation de la croissance des cheveux



Placas de Cerâmica com Turmalina que cuidam do cabelo proporcionando brilho e suavidade, mediante o seu carregamento iônico previne a eletrização dos cabelos e que estes fiquem encrespados, a tecnologia Nano Silver (elimina as bactérias). Função de auto desconexão: o aparelho desliga-se de forma automática, caso não seja utilizado passados cerca de 60 minutos. A luz infravermelha que desintoxica e desinfeta o cabelo e ao mesmo tempo reduz a agressão do calor das placas. As suas principais propriedades são a melhoria da circulação e estimulação do crescimento do cabelo

- » Température: entre 130°C et 230°C
- » Puissance: 44W
- » Thermostat de sécurité
- » Indicateurs de câble: câble de 2,7 m avec rotation à 360°
- » Chauffage des plaques: 20 secondes
- » Résistance MCH
- » Écran LCD qui indique la température
- » Thermostat interne qui évite la surchauffe.
- » Manche «SOFT-TOUCH»
- » Céramique et tourmaline

- » Temperatura: entre 130°C e 230°C
- » Potência: 44W
- » Termóstato de segurança
- » Cabos: 2,7 m com rotação 360°
- » O aquecimento das demora: 20 segundo
- » Resistência MCH
- » LCD que indica a temperatura
- » Termostato interno que evita o sobreaquecimento.
- » Cabo "SOFT-TOUCH"
- » Cerâmica e turmalina



REF. 06331/68

Fer à lisser professionnel FRIZZE

Prancha profissional FRIZZE



Plaques de tourmaline qui prennent soin des cheveux en leur fournissant éclat et douceur, grâce à sa charge ionique qui empêche les cheveux d'électriser et de friser, grâce à la technologie Nano Silver (élimine les bactéries)

Placas de Turmalina que cuidam o cabelo proporcionando-lhe brilho e suavidade, mediante a sua carga iónica previne a eletricidade estática e o encrespamento do cabelo, com tecnologia Nano Silver (elimina as bactérias)



REF. 06163/68



- » Température: entre 130°C et 230°C
- » Puissance: 65W
- » Thermostat de sécurité
- » Indicateurs de câble: câble de 3 m avec rotation à 360°
- » Tension: 110 - 240 V~
- » Fréquence: 50/60 Hz
- » Déconnexion automatique
- » Résistance: Chauffage ultra-rapide avec résistance PTC
- » Réglage de la température via le cadran
- » Contrôle par microprocesseur
- » Finition Soft Touch
- » Céramique et tourmaline
- » 3 plaques interchangeables
- » Pour les cheveux naturels
- » NE PAS UTILISER POUR LES CHEVEUX SYNTHÉTIQUES OU MOUILLÉS

- » Temperatura: entre 130°C e 230°C
- » Potência: 65W
- » Termóstato de segurança
- » Cabos: 3 m com rotação 360°
- » Voltagem: 110 - 240 V~
- » Frequência: 50/60 Hz
- » Desliga automaticamente
- » Resistência: Aquecimento ultrarrápido com resistência PTC
- » Ajusta a temperatura através do dial
- » Controle por microprocessador
- » Acabamento Soft Touch
- » Luz indicadora de temperatura
- » Cerâmica e turmalina
- » 3 placas intercambiáveis
- » Para cabelo natural
- » NÃO UTILIZAR EM CABELO SINTÉTICO OU MOLHADO

Fer à lisser professionnel en céramique et tourmaline

Prancha profissional cerâmica e turmalina



Plaques en céramique et Tourmaline qui prennent soin des cheveux en leur fournissant éclat et douceur, grâce à sa charge ionique qui empêche les cheveux d'électriser et de friser, grâce à la technologie Nano Silver (élimine les bactéries)

Placas de cerâmica com Turmalina que cuidam o cabelo proporcionando brilho e suavidade, através da sua carga iônica previne a eletricidade estática e o encrespamento do cabelo, com tecnologia Nano Silver (elimina as bactérias)



REF. 06173/50



REF. 06173/53



REF. 06173/70



- » Température réglable entre 80°C et 230°C
- » Puissance: 43W
- » Thermostat interne qui évite la surchauffe.
- » Câble pivotant en caoutchouc à 360° et 3 m de long
- » Tension: 110 - 240 V~
- » Fréquence: 50/60 Hz
- » Affichage LCD indiquant la température
- » Déconnexion automatique après 60 minutes
- » Résistance: Chauffage des plaques en seulement 20 secondes, avec résistance MCH
- » Réglage de la température en utilisant des boutons
- » Manche "SOFT-TOUCH"
- » Mémoire de température
- » Pour les cheveux naturels
- » NE PAS UTILISER SUR CHEVEUX SYNTHÉTIQUES OU MOUILLÉS

- » Temperatura ajustável entre 80°C e 230°C.
- » Potência 43W
- » Termóstato interno que evita o sobreaquecimento
- » Cabo rotativo de 360°, de borracha e de 3 m
- » Voltagem: 110 - 240 V~
- » Frequência: 50/60 Hz
- » Display LCD indica a temperatura
- » Função de desligar automaticamente: passado uns 60 minutos
- » Resistência: Aquecimento das placas em apenas 20 segundos, com resistência MCH
- » Ajuste a temperatura por botões
- » Controle microprocessado
- » Pega "SOFT-TOUCH"
- » Memória de temperatura
- » Para cabelo natural
- » NÃO UTILIZAR EM CABELO SINTÉTICO OU MOLHADO

Fer à lisser professionnel en titane
Prancha profissional titânio

Plaques en titane qui prennent soin des cheveux pour leur donner de la brillance et de la douceur, la technologie Nano Silver (élimine les bactéries)

Placas de Titânio que cuidam o cabelo proporcionando brilho e suavidade, a tecnologia Nano Silver (elimina as bactérias)



REF. 06174/50



REF. 06174/54



REF. 06174/70



- » Température réglable entre 80°C et 230°C
- » Puissance: 38W
- » Affichage LED indiquant la température
- » Câble pivotant en caoutchouc à 360° et 3 m de long
- » Tension: 110 - 240 V~
- » Fréquence: 50/60 Hz
- » Écran LCD indiquant la température
- » Déconnexion automatique après 60 minutes
- » Résistance: Chauffage des plaques en seulement 20 secondes, avec résistance MCH
- » Réglage de la température en utilisant des boutons
- » Manche "SOFT-TOUCH"
- » Mémoire de température
- » Céramique et tourmaline
- » Pour les cheveux naturels
- » NE PAS UTILISER POUR LES CHEVEUX SYNTHÉTIQUES OU MOUILLÉS

- » Temperatura ajustável entre 80°C e 230°C.
- » Potência: 38W
- » Termóstato interno que evita o sobreaquecimento
- » Cabo rotativo de 360°, de borracha e de 3 m
- » Voltagem: 110 - 240 V~
- » Frequência: 50/60 Hz
- » Display LCD indica a temperatura
- » Função de desligar automaticamente: passado uns 60 minutos
- » Resistência: Aquecimento das placas em apenas 20 segundos, com resistência MCH
- » Ajuste a temperatura por botões
- » Pega "SOFT-TOUCH"
- » Memória de temperatura
- » Cerâmica e turmalina
- » Para cabelo natural
- » NÃO UTILIZAR EM CABELO SINTÉTICO OU MOLHADO

Redresseur de cheveux professionnel advance

Prancha profissional advance



Plaques en céramique et tourmaline qui prennent soin des cheveux pour leur donner de la brillance et de la douceur, la technologie Nano Silver (élimine les bactéries)

Placas de cerâmica com Turmalina que cuidam o cabelo proporcionando brilho e suavidade, a tecnologia Nano Silver (elimina as bactérias).



REF. 06139/50

REF. 06139/70

REF. 06139/71



- » Température réglable entre 130°C et 230°C
- » Puissance: 50W
- » Câble pivotant en caoutchouc à 360° et 2,7 m de long
- » Tension: 110 - 240 V~
- » Fréquence: 50/60 Hz
- » Affichage LED indiquant la température
- » Déconnexion automatique après 60 minutes
- » Résistance: Chauffage des plaques en seulement 20 secondes, avec résistance de type MCH
- » Réglage de la température via les boutons
- » Manche "SOFT-TOUCH"
- » Pour les cheveux naturels
- » NE PAS UTILISER POUR LES CHEVEUX SYNTHÉTIQUES OU MOUILLÉS

- » Temperatura ajustável entre 130°C e 230°C.
- » Potência: 50W
- » Termóstato interno que evita o sobreaquecimento
- » Cabo rotativo de 360°, de borracha de 2,7 m
- » Voltagem: 110 - 240 V~
- » Frequência: 50/60 Hz
- » Display LCD indicando a temperatura
- » Função de desligar automaticamente: passado uns 60 minutos
- » Resistência: Aquecimento das placas em apenas 20 segundos, com resistência MCH.
- » Ajuste a temperatura via botões
- » Pega "SOFT-TOUCH".
- » Para cabelo natural
- » NÃO UTILIZAR EM CABELO SINTÉTICO NEM MOLHADO

Fer à lisser professionnel ionic Prancha profissional ionic



Plaques en céramique et tourmaline qui prennent soin des cheveux pour leur donner de la brillance et de la douceur, la technologie Nano Silver (élimine les bactéries)

Placas de cerâmica com Turmalina que cuidam o cabelo proporcionando brilho e suavidade, a tecnologia Nano Silver (elimina as bactérias)



REF. 06138/50

REF. 06138/59

REF. 06138/53



- » Température réglable entre 130°C et 230°C
- » Puissance: 44W
- » Thermostat interne qui évite la surchauffe
- » Câble pivotant en caoutchouc à 360° et 2,7 m de long
- » Tension: 110 - 240 V~
- » Fréquence: 50/60 Hz
- » Affichage LED indiquant la température
- » Déconnexion automatique après 60 minutes
- » Résistance: Chauffage des plaques en seulement 20 secondes, avec résistance de type MCH
- » Réglage de la température via les boutons
- » Manche "SOFT-TOUCH"
- » Générateur d'ions, qui adoucit et hydrate les cheveux, en réduisant le temps de séchage
- » Système de fermeture des plaques au moyen d'un levier
- » Céramique et tourmaline
- » Pour les cheveux naturels
- » NE PAS UTILISER POUR LES CHEVEUX SYNTHÉTIQUES OU MOUILLÉS

- » Temperatura ajustável entre 130°C e 230°C.
- » Potência: 44W
- » Termóstato interno que evita o sobreaquecimento
- » Cabo rotativo de 360°, de borracha de 2,7 m
- » Voltagem: 110 - 240 V~
- » Frequência: 50/60 Hz
- » Display LCD indicando a temperatura
- » Função de desligar automaticamente: passado uns 60 minutos
- » Resistência: Aquecimento das placas em apenas 20 segundos, com resistência MCH
- » Ajuste a temperatura via botões
- » Pega "SOFT-TOUCH"
- » Gerador de iões, que suaviza e hidrata o cabelo, reduzindo o tempo de secagem
- » Sistema de fecho das placas através de alavanca
- » Cerâmica e turmalina
- » Para cabelo natural
- » NÃO UTILIZAR EM CABELO SINTÉTICO NEM MOLHADO

Fer à lisser céramique Prancha cerâmica

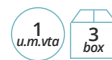

REF. 06145



- » Température réglable entre 150°C et 230°C
- » Puissance: 48W
- » Câble pivotant en caoutchouc à 360° de 2,7 m de long
- » Tension: 220 - 240 V~
- » Fréquence: 50/60 Hz
- » Déconnexion automatique après 60 minutes
- » Résistance: Chauffage des plaques en seulement 20 secondes, avec résistance de type MCH
- » Réglage de la température via le cadran
- » Système de fermeture des plaques au moyen d'un levier
- » Générateur d'ions
- » NE PAS UTILISER POUR LES CHEVEUX SYNTHÉTIQUES OU MOUILLÉS

- » Temperatura ajustável entre 130°C e 230°C
- » Potência: 48W
- » Cabo rotativo de 360° de 2,7 m
- » Voltagem: 220 - 240 V~
- » Frequência: 50/60 Hza
- » Função de desligar automaticamente: passado uns 60 minutos
- » Prancha com placas de cerâmica e turmalina basculantes
- » Aquecimento das placas em apenas 20 segundos, com resistência MCH
- » Ajuste a temperatura por discagem
- » Sistema de fecho de placas
- » Gerador de iões
- » NÃO UTILIZAR EM CABELO SINTÉTICO NEM MOLHADO



Mini fer à lisser plaques céramique basculantes

Mini prancha placas cerâmica basculantes



Fer à cheveux en céramique et tourmaline qui prend soin des cheveux et leur apporte brillance et douceur
Placas de Cerâmica com Turmalina que cuidam do cabelo proporcionando brilho e suavidade

REF. 06568/50

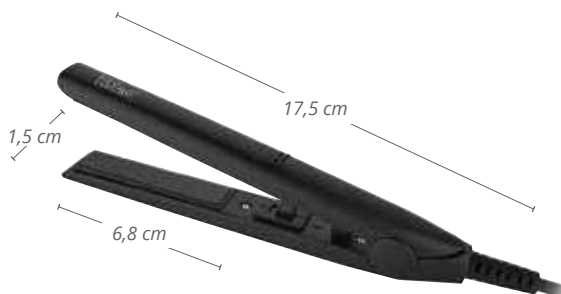

- » Température maximale 200°C
- » Puissance 22W
- » Thermostat de sécurité
- » Câble en caoutchouc de 2 m
- » Tension 100 - 240 V ~
- » Fréquence : 50/60 Hz
- » Échauffement des plaques en seulement 30 secondes, avec une résistance de type PTC
- » Résistance PTC qui évite les surchauffes
- » Apte pour tout type de cheveux naturels
- » NE PAS UTILISER SUR CHEVEUX SYNTHÉTIQUES
- » NE PAS UTILISER SUR CHEVEUX MOUILLÉS

REF. 06568/68



- » Temperatura máxima 200°C
- » Potência 22W
- » Termóstato de segurança
- » Cabo de borracha 2m
- » Tensão 100-240 V~
- » Frequência: 50/60 Hz
- » Aquecimento de placas em apenas 30 segundos, com resistência PTC
- » Resistência PTC que evita o sobreaquecimento
- » Adequada para qualquer tipo de cabelo natural
- » NÃO USAR EM CABELO SINTÉTICO.
- » NÃO ADEQUADA PARA CABELO MOLHADO

REF. 06568/70



Accessoires

Complementos



REF. 02991

- » Support pour fer à lisser étroit de type (06139). Avec des ventouses.

- » Suporte para prancha estreita tipo (02926). Com ventosas.



REF. 03076

- » Protecteur de doigts pour hautes températures

- » Protetor de dedos para altas temperaturas



REF. 03857

- » Gant 3 doigts thermorésistants protection haute température

- » Luvas 3 dedos protetor altas temperaturas



Brosse lissante
Escova alisadora



REF. 04583



- » Température entre 80°C et 230°C
- » Puissance: 55W
- » Thermostat interne qui évite la surchauffe
- » Câble pivotant 360° 2,5 m de longueur
- » Tension: 220-240V~
- » Écran LCD
- » Déconnexion automatique en 60 min. Si non utilisé
- » Pour cheveux naturels
- » NE PAS UTILISER SUR CHEVEUX SYNTHÉTIQUES OU MOUILLÉS

- » Temperatura entre 80°C e 230°C
- » Potência: 55W
- » Termóstato interno que evita o sobreaquecimento
- » Cabo rotativo 360° de 2,5 m
- » Voltage 210-240V~
- » Display LCD
- » Desliga automaticamente em 60 min. Se não se usa
- » Para cabelo natural
- » DO NOT USE FOR SYNTHETIC OR WET HAIR



Brosse lissante à vapeur

Escova prancha de vapor



Nouvelle brosse lissante à technologie vapeur Eurostil de dernière génération et design, permet de lisser vos cheveux sans les abimer grâce à sa vapeur d'eau qui protège les cheveux contre la déshydratation lors du défrisage. Les cheveux seront lisses, brillants et sains. Usage professionnel

Nova prancha de vapor com escova Eurostil de última geração e design exclusivo, permite alisar o seu cabelo sem danificá-lo devido ao seu vapor de água que protege o nosso cabelo contra a desidratação durante o alisamento. O cabelo terá um aspeto e acabamento suave, brilhante e saudável. Uso profissional



REF. 04737/50

REF. 04737/58

REF. 04737/68

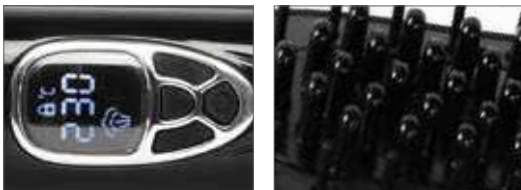

- » Température réglable entre 150°C et 230°C
- » Puissance: 75W
- » Thermostat interne qui empêche la surchauffe
- » Câble pivotant en caoutchouc à 360°, évitant les enchevêtrements possibles et 2,5 m de longueur
- » Tension 220-240V~
- » Fréquence: 50/60 Hz
- » Écran LCD indiquant la température
- » Déconnexion automatique en 60 min
- » Résistance: Chauffage en seulement 90 secondes, avec résistance de type PTC
- » Réglage de la température via le cadran
- » Convient à tout type de cheveux naturels. NE PAS UTILISER DANS LES CHEVEUX SYNTHÉTIQUES
- » Fonction de vaporisation d'eau

- » Temperatura ajustável entre 150°C e 230°C
- » Potência 75W
- » Termóstato interno que evita o sobreaquecimento
- » Cabo rotativo 360°, de borracha evitando assim possíveis entrelaçamentos de 2,5 m
- » Voltagem 210-240V~
- » Frequência: 50/60 Hz
- » Display LCD indicam a temperatura
- » Desliga automaticamente em 60 min
- » Resistência: Aquecimento em apenas 90 segundos, com resistência PTC
- » Adjust temperature by dial
- » Função de vapor de água
- » Apta para qualquer tipo de cabelo natural
- » NÃO UTILIZAR EM CABELLO SINTÉTICO

Avec double sense de rotation
Rotação de sentido duplo



Puissance: 45W
 Potência 45W

REF. 04637

Ø 13-25



13 cm



Puissance: 70W
 Potência 70W

REF. 04639

Ø 32



13,5 cm

- » Température réglable entre 100° et 220°C
- » Le thermostat interne empêche la surchauffe
- » Câble pivotant en caoutchouc 360° et 2,5m de longueur
- » Écran LCD
- » Fonction d'arrêt de sécurité automatique
- » Revêtement de tubes en céramique et tourmaline
- » Boutons de rotation de Fer à friser (droite ou gauche)
- » Manche blanc perlé
- » Convient à tous les cheveux naturels
- » NE CONVIENT PAS AUX CHEVEUX SYNTHÉTIQUES OU MOUILLÉS

- » Temperatura ajustável entre 100°C e 220°C
- » Termóstato interno que evita sobreaquecimento
- » Cabo rotativo 360°, de borracha e de 2,5 m
- » Display LCD
- » Função de desligar automaticamente de segurança
- » Revestimento dos tubos em cerâmica e turmalina
- » Botões de rotação do ferro (direita ou esquerda)
- » Aperto de cor branco pérola
- » Apto para qualquer tipo de cabelo natural
- » NÃO É ADEQUADO PARA CABELOS SINTÉTICOS OU MOLHADOS



Fers à friser 3 barres

Barra tripla



REF. 04594



Ø 22



- » Température réglable entre 130° et 220°C
- » Puissance 65W
- » Câble pivotant en caoutchouc 360° et 2,5 m de longueur
- » Tension d'auto-contrôle universelle 100-240V ~
- » Écran LCD
- » Fonction d'arrêt automatique après 60 minutes sans activité
- » Revêtement de tubes en céramique et en tourmaline qui prennent soin des cheveux pour leur donner de la brillance et de la douceur
- » Système de chauffage rapide et sûr.
- » Manche "Soft-touch"
- » Pour les cheveux naturels
- » NE CONVIENT PAS AUX CHEVEUX SYNTHÉTIQUES OU MOUILLÉS

- » Temperatura ajustável entre 130°C e 220°C
- » Potência 65W
- » Cabo rotativo 360°, de borracha 2,5 m
- » Autocontrole universal voltagem 100-240V ~
- » Display LCD
- » Função de desligar automaticamente após 60 minutos sem atividade
- » Revestimento dos tubos em cerâmica e turmalina que cuidam o cabelo proporcionando brilho e suavidade
- » Sistema de aquecimento rápido e seguro
- » Aperto "soft-touch"
- » Para cabelo natural
- » NÃO É ADEQUADO PARA CABELOS SINTÉTICOS OU MOLHADOS

Conique
CónicaØ 13-25
REF. 04593Ø 19-32
REF. 04598

- » Température réglable entre 130 et 220°C
- » Puissance 65W
- » Tension d'auto-contrôle universelle 100-240V ~
- » Câble pivotant en caoutchouc 360° et 2,5 m de longueur
- » Revêtement de tubes en céramique et en tourmaline qui prennent soin des cheveux pour leur donner de la brillance et de la douceur
- » Fonction d'arrêt automatique après 60 minutes sans activité
- » Système de chauffage rapide et sûr
- » Écran LCD
- » Manche "Soft-touch"
- » Pour les cheveux naturels
- » NE CONVIENT PAS AUX CHEVEUX SYNTHÉTIQUES OU MOUILLÉS

- » Temperatura ajustável entre 130°C e 220°C
- » Potência 65W
- » Autocontrole universal voltagem 100-240V
- » Cabo de borracha rotativo 360° com 2,5 m de comprimento
- » Revestimento dos tubos em cerâmica e turmalina que cuidam o cabelo proporcionando brilho e suavidade.
- » Função de desligar automaticamente após 60 minutos sem atividade.
- » Sistema de aquecimento rápido e seguro
- » Display LCD
- » Aperto "soft-touch"
- » Para cabelo natural
- » NÃO É ADEQUADO PARA CABELOS SINTÉTICOS OU MOLHADOS



Fers à friser avec pince Ferro de frisar com braçadeira

- » Température réglable entre 185°C et 195°C
- » Puissance 25W
- » Câble pivotant en caoutchouc 360° et 2,5 m de longueur
- » Tension 230V~
- » Fréquence: 50 Hz
- » Avec pince

- » Temperatura ajustável entre 185°C e 195°C
- » Potência 25W
- » Cabo rotativo 360°, de borracha de 2,5 m
- » Voltagem 230V ~
- » Frequência: 50 Hz
- » Com braçadeira



REF. 01664



REF. 01981



REF. 01665



REF. 01666



REF. 01667

Fers à friser avec pince
Ferro de frisar com braçadeira

1
u.m.vta

12
box

- » Température réglable entre 185°C et 195°C
- » Puissance 25W
- » Câble pivotant en caoutchouc 360° et 2,5 m de longueur
- » Tension 230V~
- » Fréquence: 50 Hz
- » Avec pince

- » Temperatura ajustável entre 185°C e 195°C
- » Potência 25W
- » Cabo rotativo 360°, de borracha de 2,5 m
- » Voltagem 230V~
- » Frequência: 50 Hz
- » Com braçadeira

Ø 22



REF. 01982

Ø 25



REF. 01668

Ø 32



REF. 02797

Notre ligne la plus classique de fers à friser
A nossa linha mais clássica de ferros

Fers à friser en céramique et tourmaline

Ferros de cerâmica turmalina



- » Température réglable entre 80°C et 210°C
- » Puissance 25W
- » Thermostat pour éviter la surchauffe
- » Câble pivotant en caoutchouc 360° et 2,5 m de longueur
- » Écran LCD
- » Arrêt automatique après 60 min. sans activité
- » Revêtement en céramique et tourmaline
- » Système de chauffage rapide et sûr
- » Maintient une température constante
- » Pour les cheveux naturels
- » Manche "soft-touch"

- » Temperatura ajustável entre 80°C e 210°C
- » Potência 25W
- » Termóstato para evitar sobreaquecimento
- » Cabo rotativo 360°, de borracha de 2,5 m
- » Display LCD
- » Função de desligar automaticamente após 60 minutos sem atividade
- » Revestimento em cerâmica e turmalina.
- » Sistema de aquecimento rápido e seguro
- » Mantem a temperatura constante
- » Para cabelo natural
- » Aperto "soft-touch"



REF. 04847

Ø 19



15,6 cm

REF. 04848

Ø 22



15,6 cm

REF. 04849

Ø 25



15,6 cm

REF. 04850

Ø 28



15,6 cm

REF. 04851

Ø 32



15,6 cm

REF. 04852

Ø 38



15,6 cm

Fer à friser bi-tube**Ferro bitubo**

REF. 03413



- » Température réglable entre 185°C et 195°C
- » Puissance 25W
- » Câble pivotant en caoutchouc 360° et 2,5 m de longueur
- » Tension 230-240V~
- » Fréquence: 50 Hz
- » Idéal pour faire des ondes à l'eau
- » Système de chauffage rapide et sûr
- » Maintient une température constante
- » Boucles avec une finition plus douce et des nids

- » Temperatura ajustável entre 185°C e 195°C
- » Potência 25W
- » Cabo rotativo 360°, de borracha de 2,5 m
- » Voltagem 230-240V ~
- » Frequência: 50 Hz
- » Ideal para fazer caracóis com água
- » Sistema de aquecimento rápido e seguro
- » Mantem a temperatura constante
- » Caracóis com um acabamento mais suave e encaracolado

Fer à friser conique**Ferro cônico**

REF. 03414



- » Température réglable entre 185°C et 195°C
- » Puissance 25W
- » Tube en aluminium avec traitement Téflon
- » Système de chauffage rapide et sûr
- » Maintient une température constante

- » Temperatura ajustável entre 185°C e 195°C
- » Potência 25W
- » Tubo de alumínio com tratamento teflon
- » Sistema de aquecimento rápido e seguro
- » Mantem a temperatura constante

Brosse électrique thermique**Escova térmico-elétrica**

REF. 01949



- » Température réglable entre 185°C et 195°C
- » Puissance 25W
- » Câble pivotant en caoutchouc 360° et 2,5 m de longueur
- » Tension 230V~
- » Fréquence: 50 Hz
- » Idéal pour les boucles douces

- » Temperatura ajustável entre 185°C e 195°C
- » Potência 25W
- » Cabo rotativo 360°, de borracha de 2,5 m
- » Voltagem 230V ~
- » Frequência: 50 Hz
- » Ideal para cachos macios

Soudeur fer à boucler pour extensions Soldador ferro extensões

Puissance 21W
Potência 21W



REF. 02557



Puissance 26W
Potência 26W



REF. 02558



Mélangeur de colorant rechargeable Misturador de tinta recarregável



REF. 04092



Idéal pour mélanger les colorants rapidement et automatiquement
Ideal para misturar corantes de forma rápida e automática



- » Puissance 9W
- » Mélangeur rechargeable (charge totale 180 minutes, et fonctionne alors 80 min.)
- » S'il est vide il fonctionne 100 minutes
- » 4 bols avec caoutchouc antidérapant de 400ml et 4 pinceaux
- » S'arrête si le couvercle est ouvert
- » Sélection du temps 45-60 et 75 s
- » Avec le bouton manuel on / off, s'il est activé, fonctionne environ 3 minutes et s'arrête s'il est empêché pour une raison quelconque, après 3 minutes, il se désactive
- » Les hélices sont en acier inoxydable recouvertes de plastique
- » Pièces de rechange: RE04092 / 01
- » Couvercle de rechange de mélangeur réf.04092
- » RE03200 / 01 hélice de rechange de mélangeur Ref.03200 / 04092
- » Tension 100-240V ~
- » Dimensions 156 x 126 x 139 mm

- » Potência 9W
- » Misturador recarregável (carga total: 180 minutos - tempo de trabalho 80 min.)
- » Em vácuo trabalha 100 minutos
- » 4 taças com borracha antiderrapante de 400 ml e 4 trinchas
- » Para se abrir a tampa eleição de tempo 45-60 e 75 s
- » Com o botão manual on/off se se ativa trabalha cerca de 3 minutos e para se desativa, por algum motivo, passado 3 minutos
- » Os batedores são de aço inox revestidos de plástico
- » Recargas: RE04092/01 recarga tampa do misturador ref.04092
- » RE03200/01 recarga batedor do misturador Ref.03200/04092
- » Voltagem 100-240V
- » Dimensões 156 x 126 x 139 mm



Stérilisateur uv eurostil plastique

Esterizador uv eurostil plástico



REF. 06618

- » Puissance: 8W
- » Stérilisateur à rayons ultraviolets pour tout type d'outils aussi bien de coiffure que d'esthétique

- » Potência: 8W
- » Esterizador de raios ultravioleta para todo o tipo de ferramentas tanto de cabeleireiro como de estética



Pièces de rechange · Peças de reposição

Ampoule de rechange
Lâmpada de substituição



REF. RE06618/01



Stérilisateur uv professionnel en aluminium pour coiffure et esthétique

Esterizador eurostil u.V. Alumínio



REF. 03317

- » Puissance: 8W
- » Indiqué pour la stérilisation de petits ustensiles en plastique ou en métal, au moyen d'une ampoule uvc germicide.
- » Ne pas utiliser pour stériliser s'autres objets
- » L'ampoule dure environ 1300/1500 heures (= 1 an de fonctionnement).

- » Potência: 8W
- » Indicado para a esterilização de pequenos utensílios de plástico ou metal, através de uma lâmpada de raios uvc germicidas.
- » Não utilizar com outros objetos não indicados.
- » A lâmpada tem uma duração de cerca de 1300/1500 horas (= 1 ano de funcionamento).



Stérilisateur germicide gx4

Esterizador germicida gx4



REF. 03009/59

- » Puissance: 15W
- » Température réglable entre 20°C et 200°C
- » Ultra plat. Lumière germicide de haute qualité

- » Potência: 15W
- » Temperatura ajustável entre 20°C e 200°C
- » Ultra plano. Luz germicida elevada qualidade



Ampoule de rechange
Lâmpada de substituição



REF. RE00891/01



Stérilisateur à la chaleur sèche *sanity security* Esterilizador calor seco *sanity security*



REF. 03011

- » Puissance: 400W
- » Température réglable entre 20°C et 200°C
- » Mesures internes : 25 cm x 14,5 cm x 7 cm

- » Potência: 400W
- » Temperatura ajustável entre 20°C e 200°C
- » Medidas internas: 25 cm x 14,5 cm x 7 cm



Stérilisateur EUROSTIL quartz Esterilizador de quartzo EUROSTIL



REF. 07013

- » Quartz
- » Idéal pour les ustensiles métalliques tels que les peignes, les ciseaux, etc.
- » Comprend un sac avec des perles de quartz

- » Quartzo
- » Ideal para utensílios de metal como pentes, tesouras, etc
- » Inclui bolsa com contos de quartzo



Peigne électrique anti-poux medisana Pente elétrico anti-piolhos medisana



REF. 06584

- » Éliminer les poux et les lentes avec un simple brossage
- » Les poux sont détruits par un courant électrique au contact des dents du peigne
- » Aucun effet secondaire car les produits chimiques ne sont pas nécessaires
- » Piles incluses: 1 x 1,5v aa
- » Poids: 95 gr aprox.

- » Eliminar piolhos e lêndeas com uma simples escovação
- » Os piolhos são destruídos por uma corrente elétrica quando em contato com os dentes do pente
- » Sem efeitos colaterais porque os produtos químicos não são necessários
- » Pilhas incluídas: 1 x 1,5v aa
- » Peso: 95 gr aprox



Aspirateur à cheveux

Aspirador de pó



Le must-have pour les salons de coiffure et les barbiers. Permet de se débarrasser des impuretés sans efforts. Muni d'un filtre HEPA qui garantit une filtration haute efficacité de l'air et de la technologie sans sac qui permet de faire des économies.

Deux modes d'utilisation : manuel ou automatique.

- 1.- Mode manuel : Positionner le tas de débris devant les capteurs de l'appareil, actionner le bouton manuel et laisser aspirer.
- 2.- Mode automatique: balayez les cheveux, la poussière et les impuretés vers la base de l'unité: les capteurs infrarouges détecteront les débris et actionneront l'aspirateur. L'appareil s'éteindra automatiquement lorsque toutes les impuretés auront été aspirées.

Aspirador de Cabelo última tecnologia. No modo manual, varre os escombros para a entrada na base da unidade, prima o botão de ativação manual e deixe que o HAIR VACUUM aspire os escombros através da entrada e na Coleção Bin.

1. O modo MANUAL terá uma duração de 5 segundos. Dependendo da quantidade de resíduos, pode ser necessário premir o botão de ativação manual mais de uma vez.

2. Quando se gira o indicador de controlo para a posição AUTO, varre os resíduos para a entrada na base da unidade e os sensores detetam os resíduos iniciando automaticamente um ciclo de aspiração que terminará assim que os sensores não detetarem mais resíduos.



REF. 06612



- » Puissance nominale: 1400 W
- » Modèle: VA001A-BK
- » Tension nominale: 220-240V ~
- » Fréquence: 50 / 60Hz
- » Taille: (longueur x largeur x hauteur): 33 cm de long x 21 de large x 56,4 cm de haut
- » Poids net: sur 5,1 kg
- » Opération Bruit: ≥83db 1.5m
- » Mode de travail automatique: Introduction de rayonnement infrarouge
- » Aspiration (force de traction): ≥2,8 kg
- » Capacité du réservoir à ordures: 2,7 L MAX
- » Taille de cordon d'alimentation: 2m+

- » Potência nominal: 1400 W
- » Modelo: VA001A-BK
- » Tensão nominal: 220-240V ~
- » Frequência: 50 / 60Hz
- » Tamanho: (comprimento x largura x altura): 33 cm de comprimento x 21 de largura x 56,4 cm de altura
- » Peso líquido: cerca de 5.1 kg
- » Ruído de operação: ≥83db 1.5m
- » Modo de trabalho automático: Introdução de radiação infravermelha
- » Sucção (força de tensão): ≥2,8 kg
- » Capacidade do tanque de lixo: 2.7L MAX
- » Tamanho da exposição do cabo de energia: 2m

Nettoyant pour peignes et brosses

Limpador pentes e escovas

1
u.m.vta

6
box



D'une simple pression sur un bouton, vos brosses se nettoieront en quelques secondes, vous permettant ainsi d'offrir un service inégalé à vos clients.

Apenas pressionando um botão, seus pentes e suas escovas serão limpos em poucos segundos, oferecendo um serviço melhor para você e seus clientes.

- » Puissance : 120W
- » Gagnez du temps pour le nettoyage de vos brosses et peignes
- » Démarquez-vous en offrant un niveau d'hygiène élevé à votre clientèle
- » Gardez vos brosses impeccables après chaque utilisation
- » Vous aide à mieux travailler

- » *Potência: 120W*
- » *Para maximizar o tempo, a limpeza das escovas e dos pentes será automática*
- » *Mantenha as escovas limpas após cada uso*
- » *Ajuda a fazer o trabalho melhor*

REF. 06954



02

Articles de coloration

ARTIGOS DE
COLORAÇÃO

*Bols, pinceaux, balances, capes, gants,
papier d'aluminium, peignoirs de coiffure...*

*Taças, trinchas, básculas, capas, luvas,
papel alumínio, penteadores...*



Accessoires
Acessórios36
u.m.vta 36
box

REF. 00699

Éponge à neutraliser avec poignée
*Espunja neutralizar com suporte*36
u.m.vta 36
box

REF. 00971

Éponge de recharge
*Troca esponja*12
u.m.vta 120
box

REF. 03035

Spatule Applicateur 18 cm
*Espátula aplicadora 18 cm***Palettes spéciales à mèches**
Paletas especiais madeixas

Les palettes sont idéales pour le travail de balayage et les mèches californiennes. Elles fournissent un appui pour soutenir les mèches de cheveux pour appliquer la teinture ou la décoloration. Le balayage de cheveux est une technique française qui est devenue populaire depuis quelques temps. Cette technique a beaucoup évolué depuis son apparition. Le balayage est une technique de coloration partielle qui consiste à éclaircir ou foncer la couleur de base, en colorant ou tous les types de mèches: Les mèches californiennes classiques, aussi bien pour les blondes que pour les brunes.

As paletas são ideais para realizar trabalhos de balayage e madeixas californianas. Já que trazem um suporte onde apoiar as madeixas de cabelo para aplicar a tinta ou a descoloração. O balayage é uma técnica francesa que ficou na moda nos anos 90, com a qual se consegue uma distribuição uniforme de luminosidade na sua cabeleira.

A palavra "balayage" significa varrer e é precisamente assim, varrendo a cor desde a raiz até às pontas, conseguindo um look natural e luminoso. As madeixas californianas clássicas, tanto para loiras como para morenas

10
u.m.vta 100
box

REF. 01845

48
u.m.vta 48
box

REF. 00977

10
u.m.vta 60
box

REF. 02172



Accessoires
AcessóriosClé presse-tube
*Chave para exprimir tubos*1 u.m.vta
100 box

REF. 02537

Peigne applicateur ROLL-KA
*Pente ROLL-KA aplicador de produto*1 u.m.vta
6 box

REF. 02680

**Presse-tube**
ExpositorPetit presse-tube en aluminium
*Expositor de alumínio pequeno*1 u.m.vta
12 box

REF. 01959

Petit presse-tube en aluminium
*Expositor de alumínio pequeno*1 u.m.vta
12 box

REF. 03398

Petit presse-tube en aluminium
*Expositor de alumínio pequeno*1 u.m.vta
10 box

REF. 01496

**Presse-tube**
ExpositorPresse-tube de différents types de couleurs
*Expositor de tubos cores*60 u.m.vta
60 box

REF. 01386

Sachet contenant 10 presse-tubes métalliques
*Bolsa 10 expositores metálicos*1 u.m.vta
12 box

REF. 02590

Sachet contenant 1 Presse-tube métallique de couloir noir
*Bolsa 1 expositor metálico preto*12 u.m.vta
240 box

REF. 03521



Boîte de 200 spéciales Bandes à mèches plastifiées 9,5 x 30 cm
Caixa 200 tiras especial madeixas plastificadas 9,5 x 30 cm



REF. 04679



REF. 04679/53



REF. 04679/54



- » Boîte de 200 spéciales bandes spéciales à mèches plastifiées 9,5 x 30 cm
- » 200 bandes de mousse de polystyrène
- » Résistantes · Légères · Flexibles · Thermiques
- » Pour une coloration rapide et facile
- » Obtenez des résultats optimaux avec les bandes de mousse Eurostil
- » Elles permettent d'appliquer le colorant plus près de la racine et d'obtenir la couleur désirée
- » Aide à différencier les mèches de différents tons avec la couleur du papier, blanc, or et argent
- » Chaque couleur de papier correspondra à une couleur de mèches
- » Mesures: 9,5 x 30 cm

CONSEILS D'UTILISATION PRATIQUE:

- » Pour les cheveux longs, placez une bande sous la mèche, appliquez le colorant et pliez-le en joignant les deux extrémités
- » Il n'est pas nécessaire de plier les côtés des bandes
- » Les propriétés thermiques des bandes Eurostil accélèrent le processus de coloration ou de décoloration. Vérifiez le développement régulièrement
- » Auto-adhésives : elles vous permettent de vérifier le processus autant de fois que vous le souhaitez

- » Caixa 200 tiras especial madeixas plastificadas 9,5 x 30 cm
- » 200 tiras de espuma de poliestireno
- » Resistentes · Ligeiras · Flexíveis · Térmicas
- » Para uma coloração rápida e fácil
- » Consiga uns resultados ótimos com as tiras de espuma Eurostil
- » Permitem aplicar a tinta mais próxima da raiz e conseguir a cor desejada.
- » Ajuda a diferenciar as madeixas de diferentes tonalidades com a cor do papel, branco, ouro e prata
- » Cada cor de papel corresponderá a uma cor de madeixas
- » Medidas: 9,5 x 30 cm

CONSELHOS PRÁTICOS DE UTILIZAÇÃO:

- » Para o cabelo longo, coloque uma tira debaixo da madeixa, aplique a tinta e dobre-a unindo as duas pontas
- » Não é necessário dobrar as laterais das tiras
- » As propriedades térmicas das tiras Eurostil aceleram o processo de coloração ou descoloração. Verifique o desenvolvimento regularmente
- » Auto-adesivas: permitem-lhe verificar o processo tantas vezes quantas as desejadas

Boîte contenant 100 bandes spéciales à mèches 0,8 mm
Caixa 100 tiras especial madeixas 0,8 mm



100 bandes = 63 gr

100 tiras = 63 gr

REF. 03338



Boîte contenant 250 grandes feuilles super mèches Caixa 250 folhas grandes super madeixas

- » Grosseur: 1,1 mm
- » Grosso: 1,1 mm



REF. 01874



Boîte contenant 100 unités de clips transparents Caixa 100 u. Clips transparentes

Il permet de suivre le processus à l'œil nu pour être transparent, sans avoir à ouvrir et fermer. Grâce à son système adhésif, il n'y a pas de fuite. C'est plus proche de la racine.

Permite seguir o processo a olho nu para ser transparente, sem a necessidade de abrir e fechar. Graças ao seu sistema adesivo, não há vazamentos. Está mais perto da raiz.



REF. 01025



Minuteur numérique Relógio digital



REF. 02539/50

- » Tension 9V~
- » Minuteur numérique avec support et aimant
- » Voltagem 9V ~
- » Relógio digital com suporte e íman



Minuteur Temporizador



REF. 01975



Balances Balanças

- » Tension 9V~
- » Afficheur LCD
- » Plage de mesure jusqu'à 5 kg
- » Unité de mesure 1 gr
- » Unités de mesure ajustables en kilogrammes ou en livres
- » Fonction de tare (poids brut avec mémoire de tare)
- » Piles non incluses

- » Voltagem 9V ~
- » Display LCD
- » Gama de medição 5 kg
- » Unidade de medida 1 gr
- » Unidades de medida ajustáveis a quilogramas ou libras
- » Função tara (peso bruto com registo de tara)
- » Pilhas não incluídas

- » Balance chromée
- » Balança cromada

REF. 03337/54

- » Balance noire mate
- » Balança preta mate

REF. 03337/50



Balances numérique EUROSTIL

Balança digital EUROSTIL



- » Design moderne
- » Capacité : 5 kg / 11 livres : 0,4 oz / 176 oz / 5 L.
- » Échelle : 1 g / 0.1 oz / 1 ml
- » Fonction Tare
- » Fonction Arrêt automatique
- » Indication de l'état de la pile
- » Quatre unités de mesure : g / lb:oz / oz / ml
- » Fonctionne avec une pile lithium CR2032 (non inclus)

- » Design moderno
- » Capacidade: 5 kg / 11 libras: 0,4 oz / 176 oz / 5 L
- » Escala: 1g / 0.1oz / 1 ml
- » Função tara
- » Função de desligar automaticamente
- » Indicação do estado da bateria
- » Quatro unidades de medida diferentes: g / lb:oz / oz / ml
- » Funciona com pilha de lítio CR2032 (não incluso)

- » Balance numérique ronde noire
- » *Balança digital redonda preta*

REF. 04803/50

- » Balance numérique ronde blanche
- » *Balança digital redonda branca*

REF. 04803/58



- » Balance numérique rectangulaire noire
- » *Balança digital retangular preta*

REF. 04804/50

- » Balance numérique rectangulaire blanche
- » *Balança digital redonda branca*

REF. 04804/58



Balance numérique TASSEL

Balança digital TASSEL



- » Ronde
- » *Redonda*

REF. 06631



Bol gradué avec caoutchouc antidérapant
Taça graduada com borracha antiderrapante



» Couleurs standard
 » Cores standard

300 ml

REF. 00647

» Noir
 » Preto

300 ml

REF. 00647/50



» Couleurs classiques
 » Cores clássicas

300 ml

REF. 00647/98



Bol avec caoutchouc antidérapant
Taça com borracha antiderrapante



» Transparent
 » Transparente

300 ml

REF. 00647/56

» Translucide
 » Translúcida

300 ml

REF. 00647/76



Bol de teinture Taça para tintura

- » Petit
- » Couleurs standard

- » Pequeno
- » Cores standard



11,5 cm



300 ml

REF. 00654

- » Petit
- » Noir

- » Pequeno
- » Preto



11,5 cm

72
u.m.vta72
box

300 ml

REF. 00654/50

- » Petit
- » Couleurs classiques

- » Pequeno
- » Cores clássicas



11,5 cm

72
u.m.vta72
box

300 ml

REF. 00654/98

- » Gros
- » Translucide

- » Grande
- » Translúcida



14,5 cm

48
u.m.vta48
box

600 ml

REF. 00655/56

- » Gros
- » Couleurs standard

- » Grande
- » Cores standard



14,5 cm



600 ml

REF. 00655

- » Gros
- » Noir

- » Grande
- » Preto



14,5 cm

48
u.m.vta48
box

600 ml

REF. 00655/50

Bol antidérapant "TERRAZA"
Taça antiderrapante "TERRAZA"

48
u.m.vta

48
box

» Translucide
 » Translúcida

550 ml

REF. 03696

550 ml

REF. 03696/50



Bol "TERRAZA"
Taça "TERRAZA"

48
u.m.vta

48
box

Bol gradué avec poignée
Taça graduada com asa

40
u.m.vta

40
box

550 ml

REF. 06426

250 ml

REF. 02340



Bol gradué avec caoutchouc antidérapant et poignée
Taça graduada com borracha antiderrapante e asa

» Translucide
 » Translúcida

250 ml

REF. 02341

» Couleurs métalliques
 » Cores metálicas

250 ml

REF. 02341/97



Bol gradué SAVE Taça graduada SAVE

20
u.m.vta

20
box

600 ml

Bol en plastique avec une partie rainurée afin de définir la quantité de produit en fonction de vos besoins, facilitant ainsi le retrait de celui-ci.

Taça de plástico com uma parte ranhurada para definir a quantidade de produto de acordo com sua necessidade, facilitando assim a retirada deste.



REF. 04967/50

REF. 04967

Bol pour accrocher au chariot de coiffure Taça tinta transparente para pendurar carros

Bol de teinture suspendu sur une surface maximale de 1,5 cm d'épaisseur. Pratique pour l'application du colorant, favorisant une application confortable, rapide et propre. (Voir photo ci-jointe).

Taça de tingimento suspensa numa superfície máxima de 1,5 cm de espessura. Prático para a aplicação do corante, favorecendo uma aplicação confortável, rápida e limpa. (Veja foto em anexo).

8
u.m.vta

8
box

700 ml

REF. 01169

14
u.m.vta

14
box

250 ml

REF. 01170

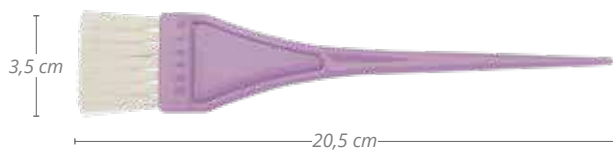

Petit pinceau teinture · Trincha tinta pequenaCouleurs standard
Cores standard144
u.m.vta144
box1
u.m.vta100
box

REF. 00101/01

REF. 00101

En vrac
GranelSac individuel
Bolsa individualCheveux noirs
Cabelo cor preto

REF. 00101/50/01

REF. 00101/50

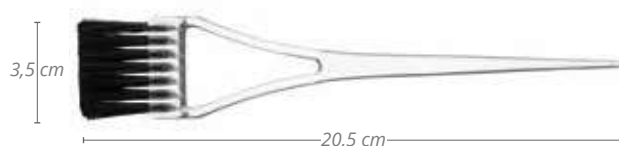
En vrac
GranelSac individuel
Bolsa individualTransparent
Transparente

REF. 00101/56/01

REF. 00101/56

En vrac
GranelSac individuel
Bolsa individualCouleurs métalliques
Cores metálicas

REF. 00101/97

Sac individuel
Bolsa individualCouleurs classiques
Cores clássicas

REF. 00101/98

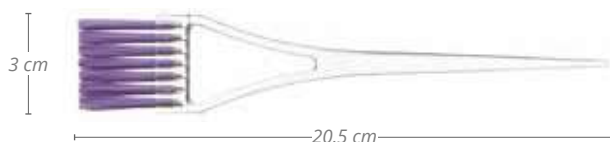
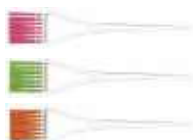
Sac individuel
Bolsa individualTransparent avec des cheveux colorés
Transparente com cabelos coloridos

REF. 00101/56/99

Sac individuel
Bolsa individual

Grand pinceau teinture · Trincha tinta grande



72 u.m.vta
72 box

REF. 00102/01

1 u.m.vta
50 box

REF. 00102



En vrac
Granel

Sac individuel
Bolsa individual

Cheveux noirs
Cabelo cor preto

REF. 00102/50/01

REF. 00102/50



En vrac
Granel

Sac individuel
Bolsa individual

Transparent
Transparente

REF. 00102/56/01

REF. 00102/56



En vrac
Granel

Sac individuel
Bolsa individual

REF. 00102/97



Sac individuel
Bolsa individual

REF. 00102/98



Sac individuel
Bolsa individual

REF. 00102/56/99



Sac individuel
Bolsa individual

Pot 24 pinceaux teinture mod.102
Set 24 trinchas mod. 102

REF. 04682

Pinceau teinture "TERRAZA"
Trincha "TERRAZA"

REF. 03697/01



REF. 03697

En vrac
GranelSac individuel
Bolsa individual**Grand pinceau teinture TASSEL "TERRAZA"**
Trincha grande TASSEL "TERRAZA"

REF. 06425

**Pinceau teinture polis SOFTLY**
Trincha tinta pegas polidas SOFTLY

REF. 04654

Petit
PequenaSac individuel
Bolsa individual

REF. 04655

Grand
GrandeSac individuel
Bolsa individual

Grand pinceau teinture spécial
Trincha tinta grande especial

REF. 01335

Sac individuel
Bolsa individual**Pinceau teinture moyen et spécial**
Trincha tinta média especial

REF. 01280

Sac individuel
Bolsa individual**Petit pinceau teinture**
Trincha tinta pequena especial

REF. 01334

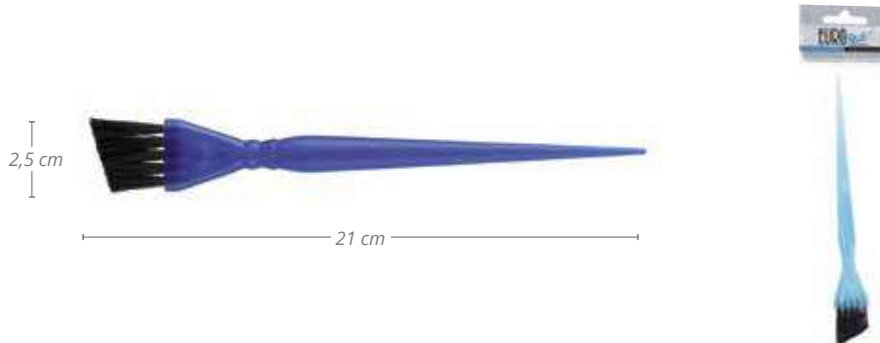
Sac individuel
Bolsa individual**Pinceau à dents en plastique**
Trincha pega plástico

REF. 03033

Sac individuel
Bolsa individual

Pinceaux teinture en silicone Trinchas silicone



Pinceaux en silicone pour l'application de la teinture d'une manière plus précise et plus rapide:

- » Application plus rapide
- » Plus près du cuir chevelu
- » Grandes économies de produit

Trinchas de silicone para a aplicação de uma forma mais precisa e rápida:

- » Aplicação mais rápida
- » Mais próximo do couro cabeludo
- » Maior poupança de produto

REF. 04297

- » Grand avec embout droit
- » Reta grande



Sac individuel
Bolsa individual

- » Grand avec embout plat incliné
- » Inclinada grande



REF. 04298

Sac individuel
Bolsa individual

- » Pointes moyennes
- » Pontas média



REF. 04299

Sac individuel
Bolsa individual

Pinceau à teinture émoussé Trincha tinta sem pontas



REF. 04739

Sac individuel
Bolsa individual

Pinceau à teinture avec peigne Trincha tinta com pente



REF. 02529/50



REF. 01128

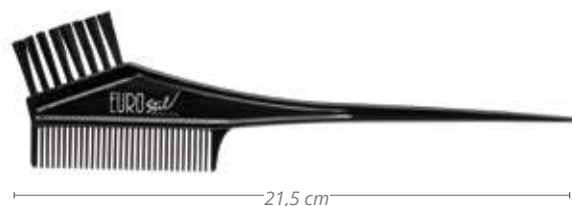

Protège-nuque Protetor pescoço

» Protège-nuque et lave-tête
» Protetor pescoço lava-cabeças



REF. 01464



» Silicone avec ventouses
» Silicone com ventosas



REF. 03258



» Cuvette spéciale Ondina
» Bacia especial Ondina



REF. 00979



» Mousse nuque pour lave-tête x2
» Bolsa 2 unidades capas lava-cabeças pretas



REF. 01363

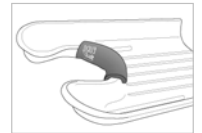

» Protège-nuque en plastique noir
» Protetor pescoço plástico preto



REF. 02522/50



» Cuvette soft
» Bacia soft



REF. 02370



» Protège-nuque en silicone pour lave-tête
» Protetor pescoço silicone para lavar cabeças



REF. 04507/60



REF. 04507/59

Comfort



REF. 04507/62



Tube à essai gradué Proveta graduada

» Tube à essai gradué
» Proveta graduada

30
u.m.vta

30
box

» Mod. TERRAZA
» Mod. TERRAZA

32
u.m.vta

32
box

150 ml

REF. 02530/50



150 ml

REF. 04285



» Avec poignée
» Com alça

36
u.m.vta

36
box

100 ml

REF. 00609



24
u.m.vta

24
box

150 ml

REF. 00604



» Avec poignée
» Com alça

16
u.m.vta

16
box

250 ml

REF. 00608



Shaker gradué Misturador graduado

24
u.m.vta

24
box

160 ml

REF. 01846



18
u.m.vta

18
box

210 ml

REF. 01144



16
u.m.vta

16
box

350 ml

REF. 00978



Bouteille doseur / applicateur
Frasco medidor / aplicador

60 ml

REF. 01112



120 ml

REF. 01235



120 ml

REF. 02527/50



240 ml

REF. 02369



250 ml

REF. 01111



250 ml

REF. 01956



260 ml

REF. 02528/50

Ensemble de 3 entonnoirs 3 tailles
Conjunto 3 funis 3 tamanhos

» Pour la parfumerie, la coiffure
 » Para perfumaria, cabeleireiro

REF. 00997

Ø: 3 cm



Ø: 4 cm



Ø: 5 cm

Cuillère doseuse
Colher doseadora

REF. 01164



Rouleau de papier d'aluminium**Rolo papel alumínio**8
u.m.vta8
box

- » Poids brut : 600 gr
- » Poids net sans mandrin: 537 gr
- » Épaisseur: 12 my +/-

- » Peso bruto: 600 gr
- » Peso líquido: 537 gr
- » Espessura: 12 microns +/-

125 m
Aprox

13 cm

REF. 01113



13 cm

REF. 01113/53



13 cm

REF. 01113/59



13 cm

REF. 01113/62



13 cm

REF. 01113/60

- » Poids brut : 475 gr
- » Poids net sans mandrin: 425 gr
- » Épaisseur: 15 my +/-

- » Peso bruto: 475 gr
- » Peso líquido: 425 gr
- » Espessura: 15 microns +/-

6
u.m.vta6
box100 m
Aprox

Avec lame de coupe
tranchante incorporée
Com lâmina de corte afiada
incorporada



12 cm

REF. 02964



12 cm

REF. 02964/53



12 cm

REF. 02964/59



12 cm

REF. 02964/62



12 cm

REF. 02964/60

Rouleau de papier d'aluminium**Rolo papel alumínio**

- » Poids brut : 475 gr
- » Poids net sans mandrin: 425 gr
- » Épaisseur: 10 my +/-

- » Peso bruto: 475 gr
- » Peso líquido: 425 gr
- » Espessura: 15 microns +/-

6
u.m.vta6
box118 m
Aprox

REF. 01139



30 cm

Rouleau de papier d'aluminium**Rolo papel alumínio**

- Avec une bande transparente
- Com franja transparente

6
u.m.vta6
box60 m
Aprox

REF. 02531

Rouleau pvc. Mandril**Rolo pvc**6
u.m.vta6
box210 m
Aprox

REF. 01198



30,5 cm



Aluminiim gaufré Gofrado de alumínio

- » Aluminium argenté brillant 18 microns, excellente qualité et gaufrage
- » Avec pate adhésive et 200 feuilles
- » Grâce à son gaufrage, les cheveux respirent davantage dans la réalisation des mèches et teintures, favorisant un meilleur résultat du travail effec

- » *Alumínio prata brilhante de 18 microns, de excelente qualidade e estampado*
- » *Com língua adesiva e 200 folhas*
- » *Graças à sua estampagem, o cabelo respira mais na realização das mechas e corantes, favorecendo um melhor resultado do trabalho realizado*



REF. 06079

- » Aluminium argenté brillant. Avec languette adhésive et 100 feuilles
- » Grâce au gaufrage de l'aluminium, et à son aspect visuel léger, il permet de visualiser le travail qui se fait sans ouvrir ni fermer le papier, facilitant et accélérant le travail du professionnel

- » *Alumínio Prata Brilhante Com língua adesiva e 100 folhas*
- » *Graças ao relevo em alumínio e à sua característica visual leve, permite visualizar o trabalho realizado sem abrir e fechar o papel, facilitando e agilizando o trabalho do profissional*



REF. 06080

- » D'excellente qualité et gaufré, rouleau de papier aluminium d'environ 18 microns et poids brut de 400 gr
- » Grâce à son gaufrage, les cheveux respirent davantage dans la réalisation des mèches et des teintures, favorisant un meilleur résultat du travail effectué
- » 9 mètres de long sur 12 cm de large

- » *Excelente qualidade e gravação, rolo de papel alumínio de aproximadamente 18 microns e peso bruto de 400 gr*
- » *Graças à sua estampagem, o cabelo respira mais na realização das mechas e corantes, favorecendo um melhor resultado do*
- » *9 metros de comprimento por 12 cm de largura trabalho realizado*



REF. 06081

- » 300 feuilles
- » 300 folhas



REF. 06193



Distributeur Dispensador



REF.02426

Protecteurs Protetores

- » Sachet de 180 unités
- » Protège-lunettes

- » Bolsa 180 u
- » Protetor óculos



REF. 03217

- » Sachet de 50 unités
- » Protection pour chaise à dossier

- » Bolsa 50 u
- » Cadeira protectora encosto

5,4 x 5,5 x 2,3 cm



REF. 03634

- » Boîte de 200 unités. Protecteur de mobile
- » Caixa 200 u. Protetor móvel



REF. 03633

- » Sachet de 2 unités. Protecteur d'oreilles
- » Bolsa 2 u. Protetor orelhas



REF. 01915

Protecteur d'oreille boîte 50 unites Protetor auricular 50 unidades

- » Dimensions: 2 * 4,5 cm
- » Poids: 0,40 gr
- » Matière plastique

- » Dimensiones: 2*4.5 cm
- » Peso: 0,40 gr
- » Material Plástico



REF. 07008

Sachet de 100 gants jetables Saco de 100 luvas descartáveis

NEW



REF. 07304



Sachet de 200 gants en plastique Saco de 200 luvas plásticas



REF. 00963



Boîte 100 gants jetables 100 Lúvas pe descartáveis

- » Gants ambidextres, qui servent pour les deux mains
- » Taille unique
- » Multi-usages
- » Matière: Plastique
- » 80 g
- » Boîte dispensatrice

- » *Ambidestro permite que cada luva seja usada para qualquer mão*
- » *Tamanho único*
- » *Multiuso*
- » *Material: Plástico*
- » *80g*
- » *Caixa dispensadora*



NEW



REF. 07257

100 Gants en polyéthylène transparent 100 Luvas transparentes de polietileno

- » 100% Polyéthylène vierge pehd 0,7 +/- 2% g / pc
- » Hypoallergénique, étanche, taille unique
- » EPI catégorie 1
- » Fabriqué et marqué CE, compatible avec l'usage alimentaire 2011/10 / CE
- » 30 Cm. Hauteur x 25 cm. Largeur des doigts x 15 cm. Largeur du poignet

- » *Polietileno hdpe 100% 0,7 +/- 2% g / pc*
- » *Analérgico, impermeável, um tamanho,*
- » *Categoria 1 EPI*
- » *Produtos e marcações CE, compatível com uso de alimentos 2011/10 / CE*
- » *30 Cm de altura x 25 cm de largura x 15 largura do pulso 15*



NEW



REF. 07804



Sachet de 2 unités. Gants professionnels Bolsa 2 u. Luvas profissionais

- » Matériel: caoutchouc
- » Material: borracha



6,5
Talla / Tamanho
REF.01672

7
Talla / Tamanho
REF.01673

7,5
Talla / Tamanho
REF.01674

8
Talla / Tamanho
REF.01675

Boîte contenant 100 gants noirs en nitrile Caixa 100 luves nitrilo pretas



PAS de poussière
SEM pó



NITRILE / NITRILLO
AQL 1,5



S

REF. 06686

M

REF. 06687

L

REF. 06688

Boîte 50 gants synthétiques Caixa 20 luvas látex pretas



PAS de poussière
SEM pó

- » Combinent la flexibilité du latex et l'élasticité du vinyle inodore.
- » Sensation de seconde peau grâce aux propriétés élastiques très similaires au latex et aux propriétés hypoallergéniques du vinyle.
- » Matière : dérivé du PVC.
- » Non stériles.
- » Couleur noire.
- » Surfaces interne et externe lisses
- » Aptes pour allergiques au latex

- » Combina a flexibilidade do látex e a elasticidade do vinil inodoro
- » Segunda sensação na pele graças às suas propriedades elásticas muito semelhantes ao látex e oferece as propriedades hipoalergênicas do vinil.
- » Material: derivado de PVC.
- » Não estéril
- » Cor preta
- » Superfícies lisas internas e externas
- » Adequado para pessoas alérgicas ao látex

NEW



M

REF. 07263

L

REF. 07264

Boîte contenant 20 gants noirs en latex Caixa 20 luvas látex pretas

LATEX / LATEX
AQL 1,5

PAS de poussière
SEM pó



S

REF. 02832

M

REF. 02833

L

REF. 02834

Boîte contenant 100 gants blancs en latex légèrement poudrés Caixa 100 luvas látex brancas com pouco pó

LATEX / LATEX
AQL 1,5

PAS de poussière
SEM pó



S/M

REF. 01671

S/M

REF. 01669

S/M

REF. 01670

Boîte contenant 100 gants vinyle Caixa 100 luvas vinil

VINYLE / VINYL
AQL 1,5

PAS de poussière
SEM pó



S

REF. 02586

M

REF.02587

L

REF. 02588

Peignoir de coiffure en caoutchouc Eurostil
Penteador borracha Eurostil



REF.01350

Peignoir de coiffure en caoutchouc BOB-TUO
Penteador borracha BOB-TUO



REF.01082

Peignoir de coiffure professionnel
Penteador profissional



REF. 03735

Peignoir de coiffure avec fermeture magnétique
Penteador fecha magnético



REF.02496

Peignoir de coiffure professionnel renforcé
Penteador profissional reforçado

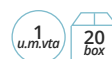

REF.00666/50

Peignoir de coiffure avec fermeture magnétique
Penteador fecha magnético



REF. 02518/50



REF. 02519/50



REF. 02519/54

Peignoir de coiffure silicone EUROSTIL
Penteador de silicone EUROSTIL



REF.07006



Peignoir de coiffure professionnel
Penteador profissional

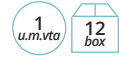

- » Matériel: nylon
- » Fermeture velcro

- » Material: nylon
- » Fecho de velcro

REF.02595/50

REF.02595/58

REF.02595/70

REF.02595/59



Ø: 80 cm



- » Matériel: nylon
- » Fermeture velcro

- » Material: nylon
- » Fecho de velcro

REF.02598/68

REF.02598/64

REF.02598/75

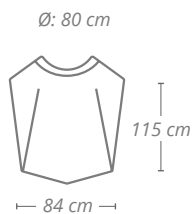

Ø: 80 cm

115 cm

84 cm



Sac 50 tabliers jetables Bolsa 50 aventais descartáveis

- » Matériel: PE
- » Épaisseur: 18 my env
- » Poids chaque tablier 10 g
- » Tablier à usage unique idéal pour protéger les vêtements.
- » Usage unique pour une hygiène impeccable

- » Material: PE
- » Espessura: 18 microns aprox
- » Peso de cada avental 10 g
- » Avental de uma só utilização ideal para proteger a roupa.
- » Utilização única para uma higiene máxima.

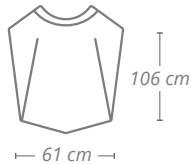

REF. 07266

NEW

Sac 30 capes blanches Bolsa 30 capas brancas

- » Matériel: Polyéthylène faible densité LDPE
- » Épaisseur plastique 20 microns
- » Fermeture lacet
- » Poids 340 g

- » Material: Polietileno baixa densidade LDPE
- » Espessura: 20 microns aprox
- » Fecha com laço
- » Peso 340 g.

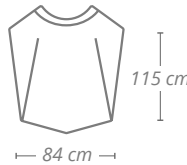

REF. 01078

NEW

Sac 30 capes noires Bolsa 30 capas pretas

- » Usage unique.
- » Descartáveis

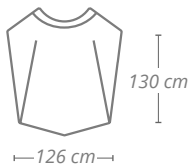

REF. 07243

Sachet contenant 50 capes jetables Bolsa 50 capas utilização única

- » Matériel P.E
- » Ribbon de fermeture
- » Épaisseur: 14 my env

- » Material P.E
- » Dara do loop
- » Espessura: 14 microns aprox

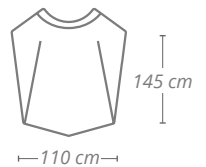

REF. 07806/50

REF. 07806/58

REF. 07806/59

NEW



Pochette contenant 30 capes jetables
Bolsa 30 capas utilização única

- » Matériel: plastique
- » Ribbon de fermeture
- » Épaisseur: 14 my env

- » Material: plástico
- » Ajuste da cintura com fitas
- » Espessura: 14 microns aprox

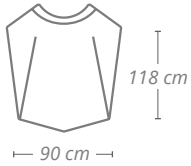

REF.02791/58



REF.02791/50



REF.02791/54



REF.02791/59



REF.02791/64



REF.02791/68



REF.02791/70



REF.02791/53

Sac contenant 50 capes jetables SIMPLE
Bolsa 50 capas utilização única SIMPLE

REF. 01207

- » Matériel: plastique
- » Ribbon de fermeture
- » Bleu

- » Material: plástico
- » Ajuste da cintura com fitas
- » Azul

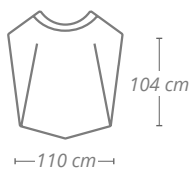
Sac contenant 30 capes jetables TASSEL
Bolsa 30 capas utilização única TASSEL

REF. 06427

- » Matériel: plastique
- » Ribbon de fermeture
- » Blanc

- » Material: plástico
- » Ajuste da cintura com fitas
- » Branca

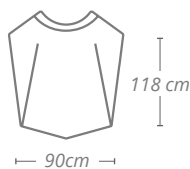
Sachet contenant 50 capes jetables
Bolsa 50 capas utilização única

REF. 02456/58

REF. 02456/59

- » Matériel P.E
- » Ribbon de fermeture
- » Épaisseur: 14 my env

- » Material P.E
- » Dara do loop
- » Espessura: 14 microns aprox

REF. 02456/60

REF. 02456/64

REF. 02456/68

REF. 02456/70

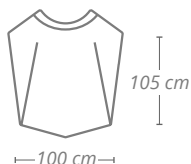
Sachet de distribution 30 capes WHITE
Bolsa 30 capas WHITE

REF. 06113/58

- » Matériel: Polyéthylène
- » Ribbon de fermeture
- » Épaisseur: 11 my env
- » Pour accroche

- » Material: Polietileno
- » Ajuste da cintura com fitas
- » Espessura: 11 microns aprox
- » Para pendurar



Rouler 50 capes jetables

Rolo 50 capas utilização única

12
u.m.vta

12
box

- » Matériel P.E
- » Ribbon de fermeture
- » Épaisseur: 14 my env.

REF. 02792/58

REF.02792/50

- » Material P.E
- » Dara do loop
- » Espessura: 14 microns aprox.



REF. 02792/59

Cape en polyester noire avec manches

Capa preta de poliéster com mangas

1
u.m.vta

12
box

- » Matériel: 100% polyester
- » Fermeture crochet

REF. 07122

- » Material: 100% Polyester
- » Fecho de gancho



Cape à teinture de coupe MISTERY

Capa corte / tinta MISTERY

1 u.m.vta
6 box

- » Matériel: 76% polyester
24% P.U.
- » Fermeture velcro
- » Hydrofuge

REF. 02505/61

REF. 02505/69

- » Matériel: plástico
- » Fermeture velcro
- » Hydrofuge

REF. 02506/50

- » Material: 76% polyester 24%
P.U.
- » Fecho de velcro
- » Repelente à água

- » Material: plástico
- » Fecho de velcro
- » Repelente à água

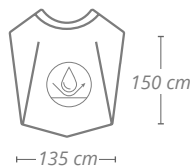
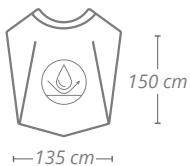

Cape à teinture de coupe FACES 2019

Capa corte FACES 2019

1 u.m.vta
12 box

- » Matériel: polyester
- » Fermeture velcro

REF. 02501/50

REF. 02501/73

- » Material: polyester
- » Fecho de velcro

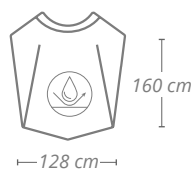

Cape de coupe LOOK Capa corte LOOK

1 u.m.vta
12 box

- » Matériel: 100 % polyester
- » Fermeture crochets
- » Hydrofuge
- » Antistatique

- » Material: 100% poliéster
- » Fecho de gancho
- » Repelente à água
- » Livre de eletricidade estática

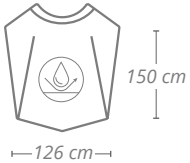

REF. 02504/75

REF. 02504/50

REF. 02504/68



Cape de coupe NIGHT Capa corte NIGHT

1 u.m.vta
12 box

- » Matériel: nylon
- » Fermeture boutons

- » Material: nylon
- » Fecho com botões

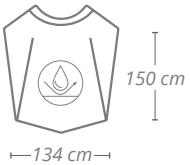

REF. 02503/50

REF. 02503/58

REF.02503/75



REF. 02503/72

REF. 02503/68

REF. 02503/62

REF. 02503/60



Cape de coupe de coiffure SCISSORS Capa corte modelo SCISSORS

1 u.m.vta
12 box

- » Matériel: 100% PVC
- » Fermeture velcro
- » Hydrofuge

- » Fecho de velcro
- » Material: 100% PVC
- » Repelente à água

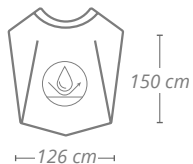

REF. 01842/68



REF. 01842/50

REF. 01842/59

REF. 01842/73



Cape MODEL Capa MADEL

1 u.m.vta
12 box

- » Matériel: 100% polyester
- » Fermeture velcro
- » Repelente al agua

- » Material: 100% polyester
- » Fecho de velcro
- » Repelente à água

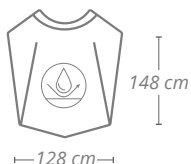

REF. 04303/50

REF. 04303/59

REF. 04303/72

Cape coupe BOB

Capa corte BOB

1
u.m.vta

12
box

- » Matériel: 100 % polyester
- » Fermeture 6 boutons
- » Hydrofuge

REF. 02632/59

REF. 02632/72

- » Material: 100% poliéster
- » Fecho com 6 botões
- » Repelente à água

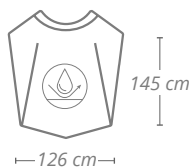

Cape à teinture de coupe FACES 2000

Capa FACES 2000

1
u.m.vta

12
box

- » Matériel: nylon
- » Fermeture velcro
- » Hydrofuge

REF. 01961/50

REF. 01961/59

- » Material: nylon
- » Fecho de velcro
- » Repelente à água

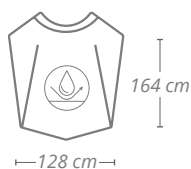

Cape de coupe EUROSTIL

Capa corte EUROSTIL

1 u.m.vta
12 box

REF. 04257/50

- » Matériel: nylon
- » Fermeture boutons
- » Hydrofuge

- » Material: nylon
- » Fecho con botões
- » Repelente à água

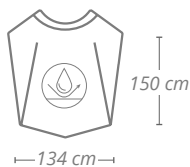

Cape de coupe BEAUTY

Capa corte BEAUTY

1 u.m.vta
12 box

REF. 04311

- » Matériel: 100% polyester
- » Fermeture velcro
- » Hydrofuge

- » Material: 100% Polyester
- » Fecho de velcro
- » Repelente à água



Cape à teinture PLACTON

Capa tinta PLACTON

1 u.m.vta
50 box

- » Matériel: PVC
- » Fermeture velcro

- » Material PVC
- » Fecho de velcro

REF. 01988/73

REF. 01988/50

REF. 01988/59

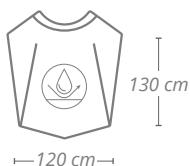

Cape de coupe ANIMAL PRINT

Capa corte ANIMAL PRINT

1
u.m.vta

12
box

- » Matériel: nylon
- » Fermeture velcro

- » Fecho de velcro
- » Material: nylon

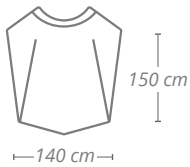

REF. 02502/58



REF. 02502/61



- » Matériel: nylon
- » Fermeture velcro

- » Material: nylon
- » Fecho de velcro

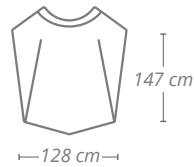

REF. 03522



REF. 03523



Cape de coupe ZEBRA

Capa corte ZEBRA

1
u.m.vta

12
box

- » Matériel: satin
- » Fermeture velcro

- » Material: cetim
- » Fecho de velcro

REF. 03524

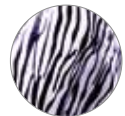
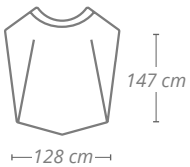

Cape à teinture DAY

Capa DAY

1
u.m.vta

12
box

- » Matériel: 65% polyester 35% coton
- » Fermeture velcro

REF. 01077/58

REF. 01077/50

- » Material: 5% polyester, 35% algodão
- » Fecho de velcro

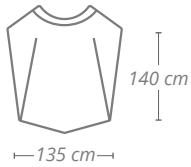

Grande cape à teinture ELEGANT

Capa grande ELEGANT

1
u.m.vta

50
box

- » Matériel: 100% polyester
- » Fermeture velcro

- » Material: 100% polyester
- » Fecho de velcro

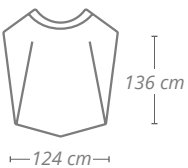

REF. 01175/60

REF. 01175/50

REF. 01175/58

REF. 01175/59

REF. 01175/72



Grande cape à teinture BROSS Capa grande BROSS

- » Matériel: plastique
- » Fermeture velcro

- » Material: plástico
- » Fecho de velcro

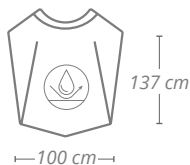

REF. 01228

- » Matériel: plastique
- » Fermeture velcro

- » Material: plástico
- » Fecho de velcro

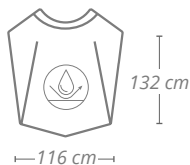

REF. 01774



Cape de coupe LIGHTS Capa corte nylon LIGHTS

- » Matériel: nylon
- » Fermeture boutons

- » Material: nylon
- » Fecho com botões

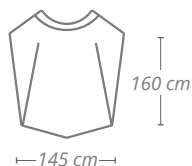

REF. 04877/54

REF. 04877/63

REF. 04877/68



Cape de coupe STYLE Capa corte STYLE

1 u.m.vta
50 box

- » Matériel: nylon
- » Fermeture boutons

- » Material: nylon
- » Fecho com botões

REF. 04876/68

REF. 04876/50

REF. 04876/58

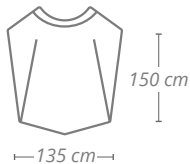

Cape de coupe FUNNY Capa corte FUNNY

1 u.m.vta
50 box

- » Matériel: polyuréthane et polyester
- » Fermeture boutons
- » Hydrofuge

- » Material: poliuretano e polyester
- » Fecho botões
- » Repelente à água

REF. 04879/50

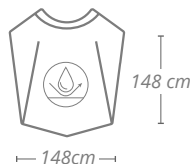

Cape de coupe teinture WAISTLINE Capa corte e tinta WAISTLINE

1 u.m.vta
12 box

- » Matériel: 65% Polyester, 35% coton
- » Fermeture velcro

- » Material: 65% Polyester, 35% Algodão
- » Fecho de velcro

REF. 01076/50

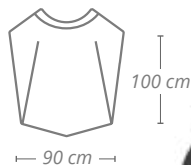

Blouse noire
Bata preta

- » Matériel: 100% polyester
- » Fermeture boutons

REF. 04301

- » Material: 100% Polyester
- » Fecho com botões



Épaule: 47 cm
Manche: 25 cm
Buste: 117 cm
Longueur: 72 cm

Ombros: 47 cm
Manga: 25 cm
Busto: 117 cm
Largura: 72 cm

Kimono
Quimono

- » Matériel: 100% polyester
- » Fermeture boutons

REF. 04300

- » Material: 100% Polyester
- » Fecho com botões



Épaule: 70 cm
Buste: 122 cm
Longueur: 106 cm

Ombros: 70 cm
Busto: 122 cm
Largura: 106 cm

Tabliers de travail
Aventais trabalho

- » Matériel: PVC transparent
- » Fermeture ribbon
- » Liserés noirs
- » Hydrofuge

REF. 01929

- » Material: PVC transparente
- » Ajuste da cintura com fitas
- » Guarnição preta
- » Repelente à água

**LONG tablier**
Avental LONG

- » Matériel: 100% nylon
- » Fermeture ribbon
- » Hydrofuge
- » Noir

REF. 04880/50

- » Material: 100% nylon
- » Ajuste da cintura com fitas
- » Repelente à água
- » Preto

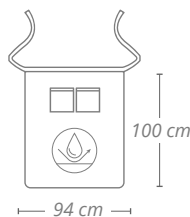

Tablier noir Avental preto

- » Matériel: 100% polyester
- » Fermeture ribbon
- » Hydrofuge

- » Material: 100% Polyester
- » Fecho de loop
- » Repelente à água

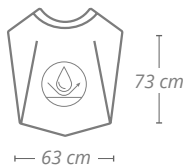

REF. 04305

Tablier avec poche Avental com bolso

- » Matériel: 100% polyester
- » Fermeture ribbon
- » Hydrofuge

- » Material: 100% Polyester
- » Fecho de loop
- » Repelente à água

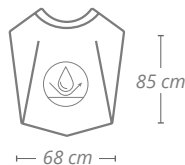

REF. 04302

Tablier de travail Avental trabalho

- » Matériel: 24% Polyuréthane, 73% Polyester
- » Fermeture ribbon
- » Hydrofuge

- » Material: 24% Poliuretano, 73% Polyester
- » Fecho de loop
- » Repelente à água



REF. 02510/50

Cape de coiffure modèle chats pour enfants**Capa infantil gatos**1
u.m.vta12
box

- » Matériel: 100% polyester
- » Fermeture velcro
- » Hydrofuge

- » Material: 100% Polyester
- » Fecho de velcro
- » Repelente à água

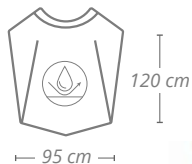

REF. 04313/68

REF. 04313/64

**Cape de coiffure modèle canetons pour enfants****Capa infantil patos**1
u.m.vta12
box

- » Matériel: 100% polyester
- » Fermeture velcro

- » Material: 100% Polyester
- » Fecho de velcro

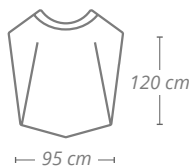

REF.02509/70

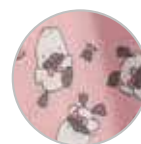

Cape de coiffure modèle CHIENS pour enfants Capa infantil CACHORROS

1
u.m.vta

12
box

- » Matériel: 100% polyester
- » Fermeture velcro

- » Material: 100% Polyester
- » Fecho de velcro

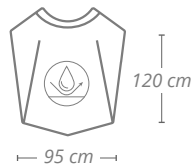

REF.02508/75



REF.02508/70



REF.02508/61



Dessins amusants disponibles en différents modèles et couleurs
Desenhos muito engraçados em diferentes modelos e cores

Vêtements professionnels Roupa profissional

** Não disponível em Portugal*



www.eurostil.com



Casaque de coeurs

Casaco de copas

MOD. 51605128

Casaque à manches courtes, avec pince poitrine et col mao, 1 poche frontale imprimée et une poche colour unie, boutons de couleur, cintrée, fentes latérales.
100 % polyester

Mini jaqueta de manga, gola "mao", 1 bolso frontal abotoado com botões coloridos, equipado com pinças, aberturas laterais.
100 % poliéster



S

98 - 102 cm
102 - 106 cm
72 - 74 cm

REF.06297/50/1

M

106 - 110 cm
108 - 112 cm
73 - 75 cm

REF.06297/50/2

L

114 - 118 cm
116 - 120 cm
75 - 77 cm

REF.06297/50/3

XL

120 - 124 cm
124 - 128 cm
77 - 79 cm

REF.06297/50/4

XXL

126 - 130 cm
136 - 140 cm
78 - 80 cm

REF.06297/50/5

MOD. 51605128

Casaque à manches courtes, avec pince poitrine et col mao, 1 poche frontale imprimée et une poche colour unie, boutons de couleur, cintrée, fentes latérales.
100 % polyester

Mini jaqueta de manga, com gola de peito e gola mao, 1 bolso frontal com padrão 1 e um simples, abotoado com botões coloridos, equipado com pinças, fendas laterais.
100 % poliéster



S

98 - 102 cm
102 - 106 cm
72 - 74 cm

REF.06297/58/1

M

106 - 110 cm
108 - 112 cm
73 - 75 cm

REF.06297/58/2

L

114 - 118 cm
116 - 120 cm
75 - 77 cm

REF.06297/58/3

XL

120 - 124 cm
124 - 128 cm
77 - 79 cm

REF.06297/58/4

XXL

126 - 130 cm
136 - 140 cm
78 - 80 cm

REF.06297/58/5

Casaque colorée
Casaco de menina colorida

1 u.m.vta 40 box

MOD. 51505003

Casaque colorée avec pince poitrine et dos et col carré, devant imprimé en diagonale avec fermeture éclair YKK, sisada et une poche, vêtement ajusté avec pinces, ouvertures latérales.

100 % polyester

Jaqueta com peito e clipe de trás e decote quadrado, frente diagonalmente impressa com zíper YKK, sisada e bolso, peça de roupa com grampos, aberturas laterais.

100 % poliéster



Longueur
Longo

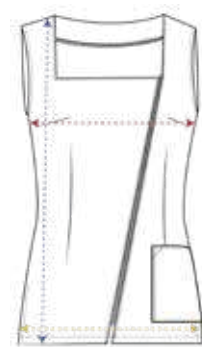

Coffre
Peito

Hanche
Quadril

S

88-92 cm
100-104 cm
69-71 cm

REF.06296/50/1

M

94-98 cm
100-108cm
71-73 cm

REF.06296/50/2

L

102-106 cm
110-114 cm
73-75 cm

REF.06296/50/3

XL

108-112 cm
120-124 cm
74-76 cm

REF.06296/50/4

XXL

118-122 cm
130-134 cm
75-77 cm

REF.06296/50/5

Casaque modele lèvres fermeture
Casaco de batom com zíper

1 u.m.vta 40 box

MOD. 51308060

Casaque avec pince poitrine et col carré, 1 face imprimée, fermeture éclair YKK sur le côté et poche cintrée, fentes latérales.

100 % polyester

Casaco com clipe no peito e decote quadrado, 1 frente estampada, zíper lateral YKK e um bolso ao vivo, equipado com pinças, fendas laterais.

100 % poliéster



Longueur
Longo

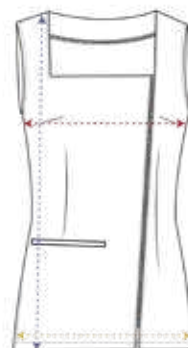

Coffre
Peito

Hanche
Quadril

S

88-92 cm
100-104 cm
69-71 cm

REF.06299/50/1

M

94-98 cm
100-108cm
71-73 cm

REF.06299/50/2

L

102-106 cm
110-114 cm
73-75 cm

REF.06299/50/3

XL

108-112 cm
120-124 cm
74-76 cm

REF.06299/50/4

XXL

118-122 cm
130-134 cm
75-77 cm

REF.06299/50/5

Casaque de cercles couleurs*Casaco de círculos coloridos*1
u.m.vta40
box**MOD. 51505005**

Casaque sans manches avec bande imprimée. Fermeture éclair YKK sur le côté. Composition 100% polyester. Deux poches, une à la taille et une sur la poitrine. Recommandé pour les magasins et les salons de beauté.
100 % polyester

Casaco básico sem mangas com tiras impressas. YKK zíper no lado. Composição 100% poliéster. Dois bolsos, um na cintura e outro no peito. Recomendado para lojas e centros de beleza.
100 % poliéster

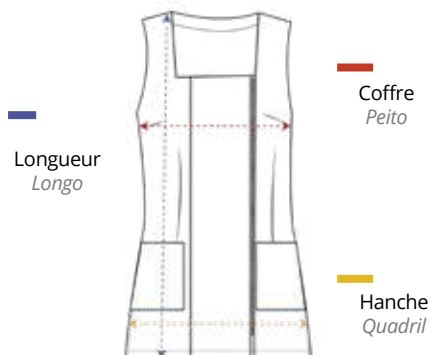

S
88-92 cm
100-104 cm
69-71 cm
REF. 06304/50/1

M
94-98 cm
100-108cm
71-73 cm
REF. 06304/50/2

L
102-106 cm
110-114 cm
73-75 cm
REF. 06304/50/3

XL
108-112 cm
120-124 cm
74-76 cm
REF. 06304/50/4

Casaque noir*Casaco preto*1
u.m.vta40
box**MOD. 51605126**

Casaque sans manches avec bande imprimée. Fermeture éclair YKK sur le côté. Composition 100% polyester. Deux poches, une à la taille et une sur la poitrine. Recommandé pour les magasins et les salons de beauté.
100 % polyester

Casaco básico sem mangas com tiras impressas. YKK zíper no lado. Composição 100% poliéster. Dois bolsos, um na cintura e outro no peito.
100 % poliéster



S
88-92 cm
100-104 cm
69-71 cm
REF. 06556/50/1

M
94-98 cm
100-108cm
71-73 cm
REF. 06556/50/2

L
102-106 cm
110-114 cm
73-75 cm
REF. 06556 /50/3

XL
108-112 cm
120-124 cm
74-76 cm
REF. 06556 /50/4

XXL
118-122 cm
130-134 cm
75-77 cm
REF. 06556/50/5

Veste zippée en polyester à manches courtes
Casaco de poliéster com zíper de manga curta

1 u.m.vta
40 box

MOD. 51308455N

Les mesures sont approximatives et appartiennent au vêtement fini du contour total. Adapté à la personne doit ajouter entre 4 et 6 cm pour le mou.

As medições são aproximadas e pertencem à peça final do contorno total. Sob medida para a pessoa deve adicionar entre 4 e 6 cm para a folga.

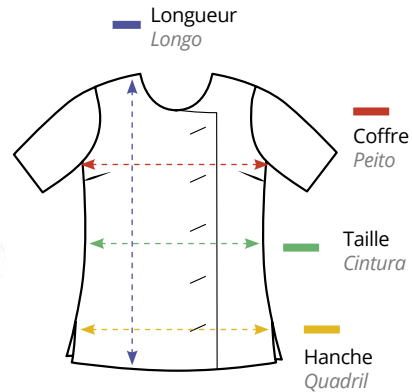

XS	S	M	L	XL	2XL
86 cm	92 cm	98 cm	106 cm	114 cm	122 cm
92 cm	98 cm	104 cm	111 cm	119 cm	127 cm
71 cm	72 cm	73 cm	74 cm	76 cm	77 cm
82 cm	88 cm	93 cm	101 cm	109 cm	116 cm
REF.07146/1	REF.07146/2	REF.07146/3	REF.07146/4	REF.07146/5	REF.07146/6

Veste sans manches avec masques faciaux
Casaco sem mangas com máscaras faciais

1 u.m.vta
40 box

MOD. 51805322

Les mesures sont approximatives et appartiennent au vêtement fini du contour total. Adapté à la personne doit ajouter entre 4 et 6 cm pour le mo

As medições são aproximadas e pertencem à peça final do contorno total. Sob medida para a pessoa deve adicionar entre 4 e 6 cm para a folga.

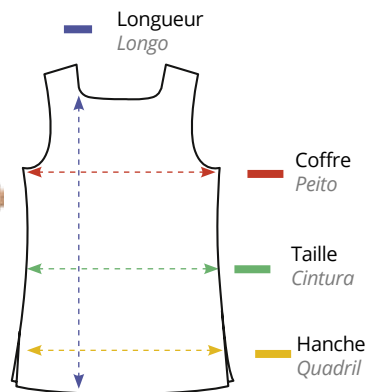

XS	S	M	L	XL	2XL
90 cm	96 cm	102 cm	110 cm	118 cm	126 cm
98 cm	104 cm	110 cm	117 cm	125 cm	133 cm
71 cm	72 cm	73 cm	74 cm	76 cm	77 cm
83 cm	89 cm	95 cm	102 cm	110 cm	118 cm
REF.07145/1	REF.07145/2	REF.07145/3	REF.07145/4	REF.07145/5	REF.07145/6

Étole coeurs

Estola menina / coração

Étole ajustée, et son rond et couleurs vives, couleur unie avec poche centrale réglage de la taille avec des rubans croisés dans le dos pour ajuster à la taille. 100% polyester

Roubou, com decote redondo e cavas polidas com cores vivas, frente lisa com bolso divisor central estampado, fundos redondos, ajuste da cintura com fitas que cruzam na parte de trás e são atados na cintura. 100% poliéster



MOD. 21502006
REF.06305/50



MOD. 21602109
REF.06306/50



MOD. 21304421
REF.06307/50



MOD. 21502001
REF.06308/50

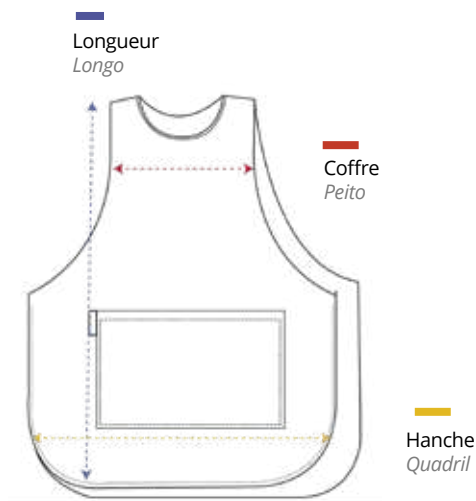

35 cm
50 cm
77 cm

Étole
Roubou



MOD.21602130

Etole, vêtement taille unique, ajustée selon les besoins. Volé mesure A.

Roubou, uma peça de vestuário de tamanho único, ajustada de acordo com as necessidades. Roubou a medida A.



MOD. 21902326

Masques faciaux estampés
Máscaras estampadas

REF.07140



MOD. 21802219

Multicœur
Multi-coração

REF.07144



MOD. 21902325

Comique
Quadrinhos

REF.07141

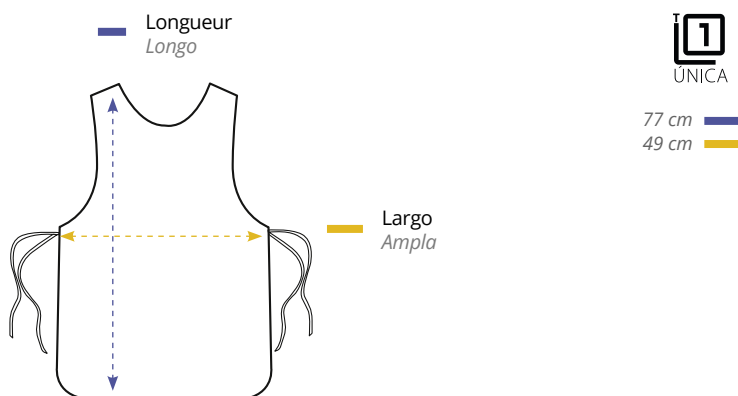

Étole
Roubou1
u.m.vta40
box**MOD.21602130**

Étole, vêtement taille unique, ajustée selon les besoins. Volé mesure A.

Roubou, uma peça de vestuário de tamanho único, ajustada de acordo com as necessidades. Roubou a medida A.

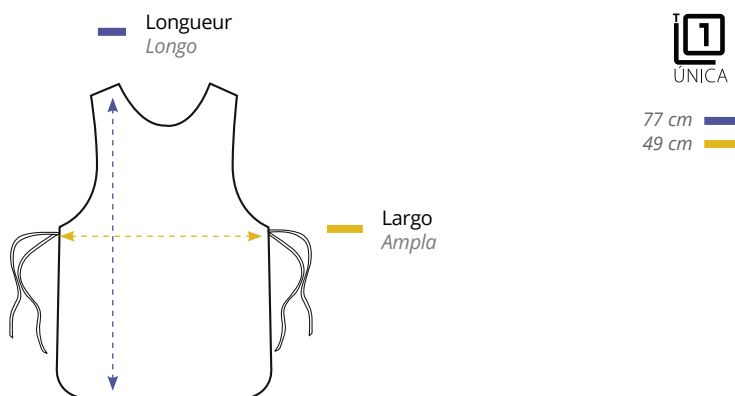
**MOD. 21802218**Mèches de cheveux
Fios de cabelo**REF.07143****MOD. 21802233**Couleurs de cheveux
Cores de cabelo**REF.07142****MOD. 21802217**Vernis à ongles
Verniz para unhas**REF.07148**

Étole 100% polyester stretch
Estola 100% poliéster

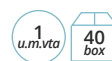

MOD. 21602124

Étole 100% Polyester Stretch. Ajustée dans le dos par un noeud. Avec grandes poches avant pratiques. Liseré rose fuchsia..
Estola 100% Poliéster Stretch. Ajustada nas costas com um laço. Com bolsos à frente grandes e cómodos. Debruada em rosa fúcsia.



Longueur
Longo



Coffre
Peito

Hanche
Quadril



35/36 cm
50/51 cm
77/78 cm

REF.06554/58

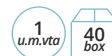

MOD. 21602124

100% polyester
100% poliéster



Longueur
Longo



Coffre
Peito

Hanche
Quadril



35/36 cm
50/51 cm
77/78 cm

REF.06554/50

Étole 100% poliyester stretch
Estola 100% poliéster stretch

1 u.m.vta
40 box

MOD. 31306075

Étole 100% Polyester Stretch. Ajustée dans le dos par un noeud. Avec poches
 Estola 100% Poliéster Stretch. Ajustada nas costas com um laço. Com bolsos



67/68 cm
79/180 cm

REF.06555

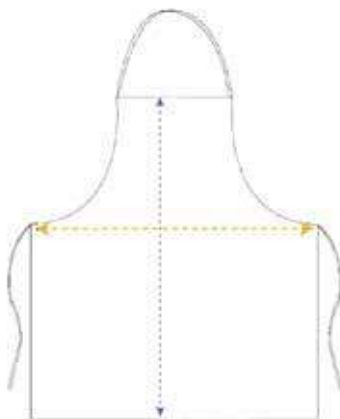

Hanche
Quadril

Longueur
Longo

Étole col mao
Estola colarinho mao

1 u.m.vta
40 box

MOD.21602130

Étole Mao, avec crochets métalliques, mini manches, avec et poches, lacets dans le dos pour ajuster à la taille.

Mao roubou, com fechos de metal, mini manga, frente com orelhas e bolsos, ajuste de cintura com fitas que cruzam na parte de trás e amarram na cintura.



Longueur
Longo

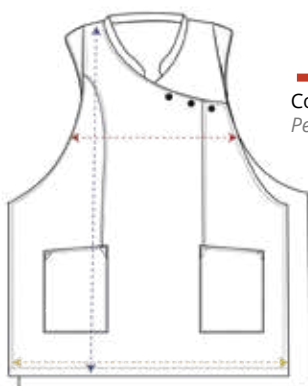

Coffre
Peito

Hanche
Quadril

100% polyester
100% poliéster

REF.06309/50



36/37 cm
59/60 cm
75/76 cm

Étole 100% polyester stretch
Estola 100% poliéster stretch

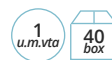

Étole 100% Polyester Stretch. Ajustée dans le dos par un noeud. Avec grandes poches avant pratiques.

Estola 100% Poliéster Stretch. Ajustada nas costas com um laço. Com bolsos à frente grandes e cómodos.



MOD. 21304601

REF.06553/50

MOD. 21304601

REF.06553/58

MOD. 21304601

REF.06553/63

MOD. 21304601

REF.06553/68

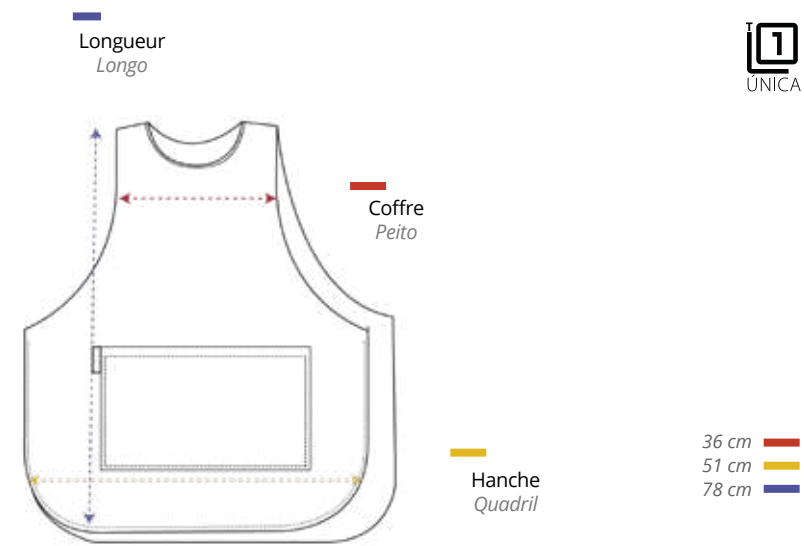

Étoles émoticons

Estola emoticon

1 u.m.vta
40 box

MOD. 21602143

Étole ajustée, et son rond et couleurs vives, couleur unie avec poche centrale réglage de la taille avec des rubans croisés dans le dos pour ajuster à la taille. 100 % polyester

Roubou, com decote redondo e cavas polidas com cores vivas, frente lisa com bolso divisor central estampado, fundos redondos, ajuste da cintura com fitas que cruzam na. 100 % polyester



36 cm
51 cm
78 cm

REF.06303/50

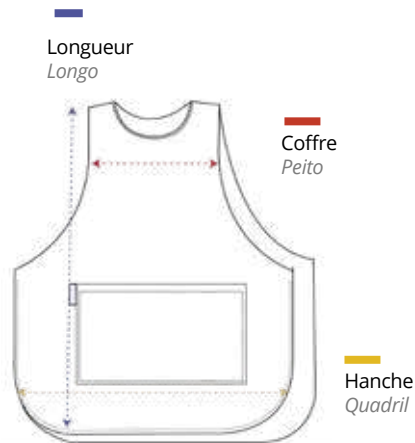

Kimono anti-statique

Quimono antiático

1 u.m.vta
40 box

MOD. 21300013

Kimono croisé avec ceinture, manche avec mini poche sur la manche. Facile à repasser. Ne déteint pas. 100% polyester marocain.

Quimono cruzado com cinto, 3/4 de controle com mini bolso na manga. Fácil de passar. 100% poliéster marroquino



123 cm
123 cm
106 cm

REF.06302/50

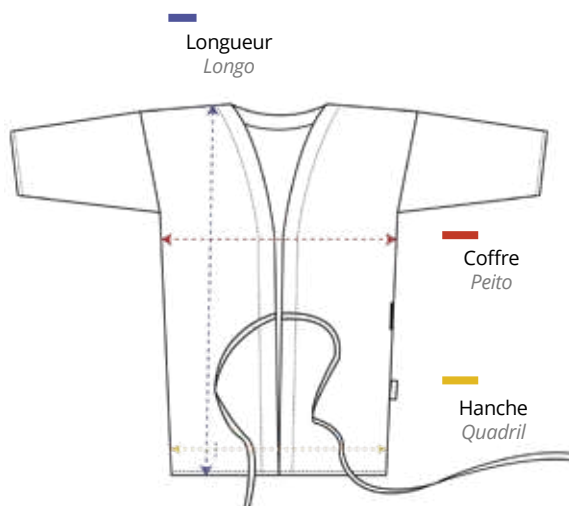

Pantalons femmes
Calças femininas

1 u.m.vta
40 box



MOD. 41300011N

Pantalons mi-haute ajustable
» 100 % polyester

Calça de tamanho médio ajustável
» 100 % poliéster

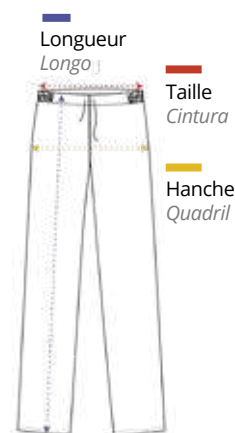

S

92-96 cm
92-96 cm
99-101 cm

REF.06312/50/1

M

98-102 cm
96-100 cm
101-103 cm

REF.06312/50/2

L

106-110 cm
106-110 cm
102-104 cm

REF.06312/50/3

XL

112-116 cm
114-118 cm
105-107 cm

REF.06312/50/4

Pantalons femmes
Calças das mulheres

1 u.m.vta
40 box



MOD. 41300011B

» 60 % polyester
» 33 % coton

» 60% poliéster
» 33% algodão

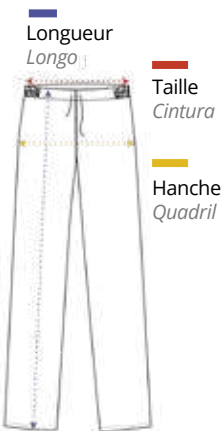

S

92-96 cm
92-96 cm
99-101 cm

REF.06312/58/1

M

98-102 cm
96-100 cm
101-103 cm

REF.06312/58/2

L

106-110 cm
106-110 cm
102-104 cm

REF.06312/58/3

XL

112-116 cm
114-118 cm
105-107 cm

REF.06312/58/4

Pantalons femmes

Calças das mulheres

1 u.m.vta
40 box

MOD. 41300901

Pantalon bi-élastique, taille basse, 2 poches latérales. Moulant
» 95 % polyester
» 37 % elast-biel

Calças bielásticas, cintura baixa, 2 bolsos laterais. Ajustado ao corpo.
95% poliéster
» 37% elast-biel

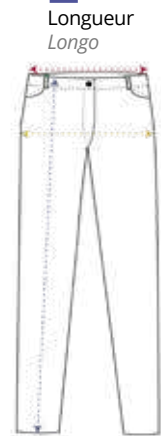

Taille
Cintura

Hanche
Quadril

36

74-78 cm
90-94 cm
100-102 cm

REF. 06311/50/1

38

78-82 cm
94-98 cm
100-102 cm

REF. 06311/50/2

40

82-86 cm
96-100 cm
101-103 cm

REF. 06311/50/3

42

88-92 cm
98-102 cm
103-105 cm

REF. 06311/50/4

44

92-96 cm
100-104 cm
105-107 cm

REF. 06311/50/5

Pantalon unisexe

Calças unisex

1 u.m.vta
40 box

MOD. 41300904

Pantalon en polyester avec 3 poches. Facile à repasser. Ne déteint pas.

Calças finas de poliéster com 3 bolsos. Cintura ajustável com cordão. Fácil de passar antideco e antiestático.



Longueur
Longo

Taille
Cintura

Hanche
Quadril



S

92-96 cm
92-96 cm
99-101 cm

REF. 06356/1

M

98-102 cm
96-100 cm
101-103 cm

REF. 06356/2

L

106-110 cm
106-110 cm
102-104 cm

REF. 06356/3

XL

112-116 cm
114-118 cm
105-107 cm

REF. 06356/4

03

Cosmétique de cheveux

COSMÉTICOS
PARA O CABELO

*Shampoings, masques, teintures,
decolorants, oxydants...*

*Champôs, máscaras, coloração,
descolorantes, oxidanes...*



Colorations Tassel Bright Colour

Coloração Bright Colour de Tassel



Coloration en Crème d'Oxydation enrichie en Huile d'Argan, en Kératine et en Cires Végétales qui aident à fixer la couleur, tout en apportant brillance et protection aux cheveux. Crème à la texture douce. Grâce à sa composition, elle prend soin des cheveux, les protège et forme une barrière protectrice pour ne pas abîmer la structure capillaire. Durabilité de la couleur et couverture maximale. Vaste gamme de couleurs qui couvrent les besoins du marché.

Tinta em Creme de Oxidação enriquecida com Óleo de Argão, Queratina e Ceras Vegetais que ajudam a fixar a cor proporcionando ao mesmo tempo brilho e proteção ao cabelo. Creme de textura suave. Devido à sua composição trata do cabelo cuidando-o, protegendo-o e formando uma barreira protetora para não danificar a estrutura capilar. Durabilidade da cor e cobertura máxima. Ampla gama de cores que cobrem as necessidades de mercado.



100 ml

100% Couverture et durabilité
Donne brillance et protection
95 couleurs intensives

100% Cobertura e durabilidade
Dá brilho e proteção
95 Cores intensas







- » Élaborés avec de l'huile d'argan, de la kératine et des cires végétales, qui aident à fixer la couleur, à apporter brillance et protection aux cheveux
- » Couleurs assorties minimum de 3 unités par couleur
- » Boîtes de 36 unités

- » Feitas com óleo de Argão, Queratina e ceras vegetais, que ajudam a fixar a cor, proporcionando por sua vez brilho e proteção ao Cabelo
- » Cores sortidas mínimo de 3 unidades por cor
- » Caixas de 36 unidades

Kératine
Cires végétales
Huile d'argan

Queratina
Ceras vegetais
Óleo de argão

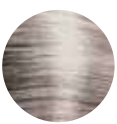
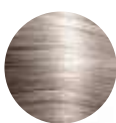
1+1,5 *New* nordic **BRIGHT COLOUR**

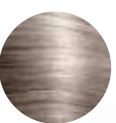
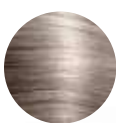
<p>Ref. 06466</p>  <p>10N ▼ RUBIO SUPER CLARO SUPER LIGHT BLONDE BLOND SUPER CLAIR ПЛАТИНОВЫЙ БЛОНДИН LOURO SUPER CLARO أشقر فاتح</p>	<p>Ref. 06469</p>  <p>10.3N ▼ RUBIO SUPER CLARO DORADO SUPER LIGHT GOLDEN BLONDE BLOND SUPER CLAIR DORÉ LOURO SUPER CLARO DOURADO СВЕТЛО-СВЕТЛЫЙ ЗОЛОТИСТЫЙ БЛОНД أشقر ذهبي فاتح جدا</p>	<p>Ref. 06467</p>  <p>10.31N ▼ RUBIO SUPER CLARO DORADO CENIZA SUPER LIGHT GOLDEN ASH BLONDE BLOND SUPER CLAIR DORÉ CENDRE LOURO SUPER CLARO DOURADO CINZA СВЕТЛО-СВЕТЛЫЙ ПЕПЕЛЬНО-ЗОЛОТИСТЫЙ БЛОНД أشقر ذهبي فاتح جدا مع رمادي</p>	<p>Ref. 06468</p>  <p>10.32N ▼ RUBIO SUPER CLARO BEIGE SUPER LIGHT BEIGE BLONDE BLOND SUPER CLAIR BEIGE LOURO SUPER CLARO BEGE СВЕТЛО-СВЕТЛЫЙ БЕЖЕ ВЬИ БЛОНД أشقر بيج فاتح جدا</p>	<p>Ref. 06465</p>  <p>9.13N ▼ RUBIO MUY CLARO CENIZA VERY LIGHT GOLDEN ASH BLONDE BLOND TRÈS CLAIR CENDRE LOURO MUITO CLARO CINZA DOURADO ОЧЕНЬ СВЕТЛЫЙ ЗОЛОТИСТО-ПЕПЕЛЬНЫЙ БЛОНД أشقر ذهبي فاتح جدا مع رمادي</p>
<p>Ref. 06463</p>  <p>9.21N ▼ RUBIO MUY CLARO BEIGE CENIZA VERY LIGHT BEIGE ASH BLONDE BLOND TRÈS CLAIR BEIGE CENDRE LOURO MUITO CLARO BEGE CINZA ОЧЕНЬ СВЕТЛЫЙ ПЕПЕЛЬНО-БЕЖЕВЫЙ БЛОНД أشقر رمادي فاتح جدا مع بيج</p>	<p>Ref. 06464</p>  <p>9.23N ▼ RUBIO MUY CLARO BEIGE DORADO VERY LIGHT GOLDEN BEIGE BLONDE BLOND TRÈS CLAIR BEIGE DORÉ LOURO MUITO CLARO BEGE DOURADO ОЧЕНЬ СВЕТЛЫЙ ЗОЛОТИСТО-БЕЖЕВЫЙ БЛОНД أشقر ذهبي فاتح جدا مع بيج</p>	<p>Ref. 06462</p>  <p>8.21N ▼ RUBIO CLARO BEIGE CENIZA LIGHT BEIGE ASH BLONDE BLOND CLAIR BEIGE CENDRE LOURO CLARO BEGE CINZA СВЕТЛЫЙ ПЕПЕЛЬНО-БЕЖЕВЫЙ БЛОНД أشقر رمادي فاتح مع بيج</p>	<p>Ref. 06461</p>  <p>8.23N ▼ RUBIO CLARO BEIGE DORADO LIGHT GOLDEN BEIGE BLONDE BLOND CLAIR BEIGE DORÉ LOURO CLARO BEGE DOURADO СВЕТЛЫЙ ЗОЛОТИСТО-БЕЖЕВЫЙ БЛОНД أشقر ذهبي فاتح مع بيج</p>	

1+3 **SUPER ACLARANTES**
SUPER LIGHTENERS · SUPER ÉCLAIRCISANTS · СИЛЬНЫЕ ОСВЕТЛИТЕЛИ · SUPERACLARADORES · ألوان جدا سفلية

<p>Ref. 03994</p>  <p>11.21 ▼ RUBIO EXTRA CLARO PERLA CENIZA PEARL ASH EXTRA LIGHT BLONDE BLOND EXTRA CLAIR PERLE CENDRE ПЛАТИНОВЫЙ БЛОНДИН С ПЕПЕЛЬНО-ЖЕМЧУЖНЫМ ОТТЕНКОМ LOURO EXTRA CLARO PERLA CINZA أشقر فاتح جدا بلؤلوي رمادي</p>	<p>Ref. 03995</p>  <p>11.00 ▼ RUBIO EXTRA CLARO NATURAL NATURAL EXTRA LIGHT BLONDE BLOND EXTRA CLAIR NATUREL ПЛАТИНОВЫЙ БЛОНДИН С НАТУРАЛЬНЫМ ОТТЕНКОМ LOURO NATURAL EXTRA CLARO أشقر فاتح جدا طبيعي</p>	<p>Ref. 04605</p>  <p>12 ▼ SUPERACLARANTE RUBIO NATURAL BLOND NATURAL SUPERLIGHTENING LOURO NATURAL SUPERÉCLAIRCISANT LOURO SUPER ACLARADOR NATURAL أشقر طبيعي عي جدا فاتح</p>	<p>Ref. 04606</p>  <p>12.1 ▼ SUPERACLARANTE RUBIO CENIZA SUPERLIGHTENING ASH BLONDE BLOND CENDRE SUPER ÉCLAIRCISANT СВЕТЛОСВЕТЛЫЙ ПЕПЕЛЬНЫЙ БЛОНД LOURO SUPER ACLARADOR CINZA أشقر رمادي جدا فاتح</p>	<p>Ref. 04610</p>  <p>12.96 ▼ RUBIO SUPERACLARANTE CENIZA VIOLETA SUPERLIGHTENING VIOLET ASH BLONDE BLOND VIOLET CENDRE SUPER ÉCLAIRCISANT СВЕТЛОСВЕТЛЫЙ ПЕПЕЛЬНЫЙ БЛОНД ОМЛЕТОВЫЙ LOURO SUPER ACLARADOR PLATINO VIOLETA فاتح جدا بنفسجي أشقر رمادي جدا</p>
--	--	--	---	---

1+1,5 **TONOS PASTEL · PASTEL TONES · TONS PASTEL · ПАСТЕЛЬНЫЕ ОТТЕНКИ · ألوان ناعمة**

<p>Ref. 07149</p>  <p>PT.0.8 ▼ ROSA PASTEL PINK PASTEL ROSE PASTEL РОЗОВЫЙ ناعم زهري</p>	<p>Ref. 07150</p>  <p>PT.0.7 ▼ LILA PASTEL LILAC PASTEL VIOLET PASTEL ИРИС ناعم ليلكي</p>	<p>Ref. 07151</p>  <p>PT.0.4 ▼ MELOCOTON PEACH-ROSE PÊCHE РОЗОВО-ПЕРСИКОВЫЙ لخوخ الناعم</p>	<p>Ref. 07152</p>  <p>PT.0.1 ▼ GRIS METÁLICO METALLIC GREY GRIS METÁLICO СЕРЫЙ МЕТАЛЛИК ناعم رمادي</p>
--	---	---	--

1+1,5

BASES NATURELES

NATURAL BASE COLOURS · BASES NATURELLES · НАТУРАЛЬНЫЕ БАЗОВЫЕ · BASES NATURAIS · أسس طبيعية

Ref. 03954



10 ▼

RUBIO SUPER CLARO
SUPER LIGHT BLONDE
BLOND SUPER CLAIR
ОЧЕНЬ СВЕТЛЫЙ БЛОНДИН
LOURO SUPER CLARO
أشقر فاتح جداً

Ref. 03955



9 ▼

RUBIO MUY CLARO
VERY LIGHT BLONDE
BLOND TRÈS CLAIR
ОЧЕНЬ СВЕТЛЫЙ БЛОНДИН
LOURO MUITO CLARO
أشقر فاتح جداً

Ref. 03956



8 ▼

RUBIO CLARO
LIGHT BLONDE
BLOND CLAIR
СВЕТЛЫЙ БЛОНДИН
LOURO CLARO
أشقر فاتح

Ref. 03957

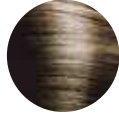

7 ▼

RUBIO MEDIO
MEDIUM BLONDE
BLOND MOYEN
СРЕДНИЙ БЛОНДИН
LOURO MEDIO
أشقر متوسط

Ref. 03958

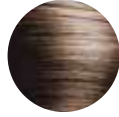

6 ▼

RUBIO OSCURO
DARK BLONDE
BLOND FONCE
ТЕМНЫЙ БЛОНДИН
LOURO ESCURO
أشقر داكن

Ref. 03959



5 ▼

CASTAÑO CLARO
LIGHT CHESTNUT
CHÂTAÎN CLAIR
СРЕДНИЙ КАШТАН
CASTANHO CLARO
كاشتانى فاتح

Ref. 03960



4 ▼

CASTAÑO MEDIO
MEDIUM CHESTNUT
CHÂTAÎN MOYEN
СРЕДНИЙ КАШТАН
CASTANHO MEDIO
كاشتانى متوسط

Ref. 03961



3 ▼

CASTAÑO OSCURO
DARK CHESTNUT
CHÂTAÎN FONCE
ТЕМНЫЙ КАШТАН
CASTANHO ESCURO
كاشتانى داكن

Ref. 03962

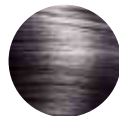

2 ▼

MORENO
BROWN
BRUN
КОРИЧНЕВЫЙ
MORENO
أسمر

Ref. 03963



1 ▼

NEGRO
BLACK
NOIR
ЧЕРНЫЙ
PRETO
أسود

1+1,5

BASES FRÍAS

COOL BASE COLOURS · BASES FROIDES · ХОЛОДНЫЕ БАЗОВЫЕ · BASES FRIAS · أسس باردة

Ref. 03964



9.01 ▼

RUBIO MUY CLARO FRÍO
COOL VERY LIGHT BLONDE
BLOND TRÈS CLAIR FROID
ОЧЕНЬ СВЕТЛЫЙ БЛОНДИН ХОЛОД
LOURO MUITO CLARO FRIO
أشقر فاتح جداً بارد

Ref. 03965



8.01 ▼

RUBIO CLARO FRÍO
COOL LIGHT BLONDE
BLOND CLAIR FROID
СВЕТЛЫЙ БЛОНДИН ХОЛОД
LOURO CLARO FRIO
أشقر فاتح بارداً

Ref. 03966



7.01 ▼

RUBIO MEDIO FRÍO
COOL MEDIUM BLONDE
BLOND MOYEN FROID
СРЕДНИЙ БЛОНДИН ХОЛОД
LOURO CLARO FRIO
أشقر متوسط بارداً

Ref. 03967



6.01 ▼

RUBIO OSCURO FRÍO
COOL DARK BLONDE
BLOND FONCE FROID
ТЕМНЫЙ БЛОНДИН ХОЛОД
LOURO ESCURO FRIO
أشقر داكن بارداً

1+1,5

VIOLETES

VIOLETS · Фиолетовые · VIOLETAS · ألوان بنفسجية

Ref. 03976



7.88 ▼

PURPURA ARDENTE
FIRRY PURPLE
ROUGE ARDENT
ОГНЕННЫЙ ПУРПУРНЫЙ
ROJO ARDENTE
ألوانى مفرحة

Ref. 03977

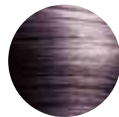

4.20 ▼

CASTAÑO MEDIO VIOLETA
MEDIUM VIOLET CHESTNUT
CHÂTAÎN MOYEN VIOLET
СРЕДНИЙ КАШТАН С
ФИОЛЕТОВЫМ ОТТЕНОКОМ
CASTANHO MEDIO VIOLETA
كاشتانى متوسط بنفسجى

Ref. 04029



1.20 ▼

NEGRO MORENO
VIOLET BLACK
NOIR VIOLET
ЧЕРНЫЙ ФИОЛЕТОВЫЙ
PRETO VIOLETA
أسود بنفسجى

1+1,5

CAOBAS · DARK AUBURN · ACAJOU

МАХАГОНОВЫЕ · ACAJU · ماهو غامق

Ref. 03987



6.54 ▼

RUBIO OSCURO CAJOU
COPPER AUBURN DARK BLONDE
BLOND FONCE ACAJOU CURINE
ТЕМНЫЙ БЛОНДИН С
МЕДНО-МАХАГОНОВЫМ ОТТЕНОКОМ
LOURO ESCURO ACAJU ACOBRADO
أشقر داكن ماهو غامق نحاسى

Ref. 03988



5.5 ▼

CASTAÑO CLARO CAJOU
LIGHT AUBURN
CHÂTAÎN CLAIR ACAJOU
СВЕТЛЫЙ КАШТАН С
МАХАГОНОВЫМ ОТТЕНОКОМ
CASTANHO CLARO ACAJU
كاشتانى فاتح ماهو غامق

1+1.3

DORADOS

GOLDEN · DORÉS · ЗОЛОТИСТЫЕ · DOURADOS · ذهنية

Ref. 03972



8.34 ▼

RUBIO CLARO DORADO COPPE
GOLDEN COPPER LIGHT BLONDE
BLOND CLAIR DORÉ COPPE
СВЕТЛЫЙ БЛОНДИН С
ЗОЛОТИСТО-МЕДНЫМ ОТТЕНКОМ
LOURO CLARO DOURADO ACOBREADO
أشقر فاتح ذهني نحاسي

Ref. 03977



5.3 ▼

CASTAÑO CLARO DORADO
LIGHT GOLDEN CHESTNUT
CHÂTAÎN CLAIR DORÉ
СВЕТЛЫЙ КАШТАН С ЗОЛОТИСТЫМ
ОТТЕНКОМ
CASTAÑO CLARO DOURADO
كشلتاني فاتح ذهني

Ref. 03973



9.3 ▼

RUBIO MUY CLARO DORADO
VERY LIGHT GOLDEN BLONDE
BLOND TRÈS CLAIR DORÉ
ОЧЕНЬ СВЕТЛЫЙ БЛОНДИН С
ЗОЛОТИСТЫМ ОТТЕНКОМ
LOURO MUITO CLARO DOURADO
أشقر فاتح جدا ذهني

Ref. 04001



5.35 ▼

CASTAÑO CLARO DORADO CAoba
LIGHT GOLDEN MAHOAGANY CHESTNUT
CHÂTAÎN CLAIR DORÉ ACAJOU
СВЕТЛЫЙ МАКАШОН С ЗОЛОТЫМ
РАШТАНОВЫМ
CASTAÑO CLARO DOURADO ACAJÚ
كشلتاني فاتح ذهني كاجو

Ref. 03974



8.3 ▼

RUBIO CLARO DORADO
GOLDEN LIGHT BLONDE
BLOND CLAIR DORÉ
СВЕТЛЫЙ БЛОНДИН С
ЗОЛОТИСТЫМ ОТТЕНКОМ
LOURO CLARO DOURADO
أشقر فاتح ذهني

Ref. 04020



7.31 ▼

RUBIO MEDIO DORADO FRIO
COOL MEDIUM GOLDEN BLONDE
BLOND MOYEN DORÉ FROID
СРЕДНИЙ ЗЕЛЕНОВАТЫЙ ЗОЛОТОЙ
ПЕПЕЛЬНЫЙ
LOURO MÉDIO DOURADO FRIO
القرقر متوسط ذهني بارد

Ref. 03975



7.3 ▼

RUBIO MEDIO DORADO
MEDIUM GOLDEN BLONDE
BLOND MOYEN DORÉ
СРЕДНИЙ БЛОНДИН С ЗОЛОТИСТЫМ
ОТТЕНКОМ
LOURO MÉDIO DOURADO
أشقر متوسط ذهني

Ref. 04342



8.31 ▼

RUBIO CLARO DORADO CINZA
LIGHT GOLDEN ASH BLONDE
BLOND CLAIR DORÉ CENDRE
СВЕТЛЫЙ ПЕПЕЛЬНЫЙ
СРЕДНО-КАШТАН
LOURO CLARO DOURADO CINZA
أشقر فاتح ذهني رمادي

Ref. 03976



6.3 ▼

RUBIO OSCURO DORADO
DARK GOLDEN BLONDE
BLOND MOYEN DORÉ ALCAJOU
ТЕМНЫЙ БЛОНДИН С ЗОЛОТИСТЫМ
ОТТЕНКОМ
LOURO ESCURO DOURADO
أشقر داكن ذهني

Ref. 04004



7.35 ▼

RUBIO MEDIO DORADO CAoba
MEDIUM GOLDEN MAHOAGANY BLONDE
BLOND MOYEN DORÉ ACAJOU
СРЕДНИЙ ЗОЛОТЫЙ ПЕПЕЛЬНЫЙ
МАКАШОН
LOURO MÉDIO DOURADO ACAJÚ
القرقر متوسط ذهني كاجو

1+1.5

CENZAS

ASH · CENORES · ПЕПЕЛЬНЫЕ · CINZAS · رمادية

Ref. 03968



8.1 ▼

RUBIO CLARO CENZA
LIGHT ASH BLONDE
BLOND CLAIR CENDRE
СВЕТЛЫЙ БЛОНДИН С
ПЕПЕЛЬНЫМ ОТТЕНКОМ
LOURO CLARO CINZA
أشقر فاتح رمادي

Ref. 03969



7.1 ▼

RUBIO MEDIO CENZA
MEDIUM ASH BLONDE
BLOND MOYEN CENDRE
СРЕДНИЙ БЛОНДИН С
ПЕПЕЛЬНЫМ ОТТЕНКОМ
LOURO MÉDIO CINZA
أشقر متوسط رمادي

Ref. 03970



6.1 ▼

RUBIO OSCURO CENZA
DARK ASH BLONDE
BLOND MOYEN CENDRE
ТЕМНЫЙ БЛОНДИН С
ПЕПЕЛЬНЫМ ОТТЕНКОМ
LOURO ESCURO CINZA
أشقر داكن رمادي

Ref. 03971



5.1 ▼

CASTAÑO CLARO CENZA
LIGHT ASH CHESTNUT
CHÂTAÎN CLAIR CENDRE
СВЕТЛЫЙ КАШТАН С
ПЕПЕЛЬНЫМ ОТТЕНКОМ
CASTAÑO CLARO CINZA
كشلتاني فاتح رمادي

Ref. 04339



1.1 ▼

NEGRO AZULADO
BLUE BLACK
NOIR BLEUÉ
ТЕМНЫЙ СИНИЙ
PRETO AZULADO
أسود أزرق

Ref. 04341



10.1 ▼

RUBIO PLATINO CENZA
ASH PLATINUM BLONDE
BLOND PLATINE CENDRE
БЛОНДИН ПЛАТИНОВЫЙ АШ
LOURO PLATINO CINZA
أشقر بلاتيني رمادي

Ref. 04019



PLATA ▼

PLATA INTENSO CENZA CENZA
ASH INTENSE SILVER
CENDRE ARGENT INTENSE
БЕЛЫЙ СЕРЕБРЯНЫЙ
БЕЛЫЙ СЕРЕБРЯНЫЙ
PRATA INTENSO CINZA
فضي مركز عال الرمادي

1+1.5

BEIGE

БЕЖЕВЫЕ · BEGE · 沙

Ref. 03978



9.32 ▼

RUBIO MUY CLARO BEIGE
VERY LIGHT BEIGE BLONDE
BLOND TRÈS CLAIR BEIGE
ОЧЕНЬ СВЕТЛЫЙ БЛОНДИН С
БЕЖЕВЫМ ОТТЕНКОМ
LOURO MUITO CLARO BEIGE
أشقر فاتح جدا بيج

Ref. 03979



8.32 ▼

RUBIO CLARO BEIGE
LIGHT BEIGE BLONDE
BLOND CLAIR BEIGE
СВЕТЛЫЙ БЛОНДИН С
БЕЖЕВЫМ ОТТЕНКОМ
LOURO CLARO BEIGE
أشقر فاتح بيج

Ref. 03980



7.32 ▼

RUBIO MEDIO BEIGE
MEDIUM BEIGE BLONDE
BLOND MOYEN BEIGE
СРЕДНИЙ БЛОНДИН С
БЕЖЕВЫМ ОТТЕНКОМ
LOURO MÉDIO BEIGE
أشقر متوسط بيج

ROJOS
REDS · ROUGES · КРАСНЫЕ · VERMELHOS · حمراء

Ref. 04340



5.6 ▼

CASTANO CLARO ROJO
LIGHT RED CHESTNUT
CHÂTAÎN CLAIR ROUGE
CERTELO-KOPVINEBNA KPAЧHЫE
CASTANHO CLARO VERMELHO
كشاندانی قاتم احمر

Ref. 04341

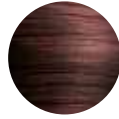

6.6 ▼

RUBIO OSCURO ROJO
DARK RED BLONDE
BLOND FONCE ROUGE
TEMNYI KPAЧHЫE ЦBETЫ
LOURO ESCURO VERMELHO
اشقر داكن احمر

Ref. 01905



6.64 ▼

RUBIO OSCURO ROJO COBRE
DARK COPPER RED BLONDE
BLOND FONCE ROUGE CUIVRE
TEMNYI KPAЧHЫE C MEДHЫM OTTEHKOM
LOURO ESCURO VERMELHO ACORREADO
اشقر داكن احمر نحاسي

Ref. 03904

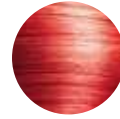

7.63 ▼

FUCOTA
CHERRY RED
COBRE
ЧЕРЕШЕВЫЙ
VERMELHO CEREA
كرزى

Ref. 06470

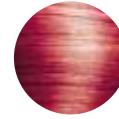

7.62 ▼

RUBIO MEDIO ROJO-CEREZA
MEDIUM CHERRY BLONDE
BLOND MOYEN CERISE
LOURO MEDIO CEREA
CPTZ-MA EPICHA CEPPELIM
اشقر متوسط كرزى

Ref. 05470



8.66 ▼

RUBIO CLARO ROJO FUEGO
LIGHT FIERY BLONDE
BLOND CLAIR FEU
CBE TИMЫ O HEHO KPAЧHЫE B OHOE
LOURO VERMELHO CLARO FOGO
اشقر نارى قاتم

COBRES
COPPERS · COUVRES · МЕДНЫЕ · ACORREADOS · نحاسية

Ref. 07000



8.44 ▼

RUBIO CLARO COBRE INTENSO
INTENSE COPPER LIGHT BLONDE
BLOND CLAIR CUIVRE INTENSE
ИHTEHCEHO MEДHЫЙ ЦBETЫB
BLOND
LOURO CLARO ACORREADO INTENSO
اشقر صاف نحاسى حاد

Ref. 01000

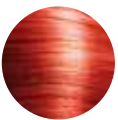

7.44 ▼

RUBIO MEDIO COBRE INTENSO
INTENSE MEDIUM COPPER BLONDE
BLOND MOYEN CUIVRE INTENSE
CPEДHЫE KPAЧHЫE C KPAHO MEДHЫM
OTTEHKOM
LOURO MEDIO ACORREADO INTENSO
اشقر متوسط نحاسى قوى

Ref. 02000

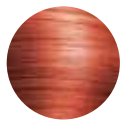

7.43 ▼

RUBIO MEDIO COBRE DORADO
MEDIUM GOLDEN COPPER BLONDE
BLOND MOYEN CUIVRE DORE
CPEДHЫE KPAЧHЫE C
ЗOЛOТACTO-MEДHЫM OTTEHKOM
LOURO MEDIO ACORREADO DOURADO
اشقر متوسط نحاسى ذهبى

Ref. 01001

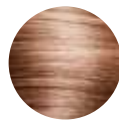

7.4 ▼

RUBIO MEDIO COBRE
MEDIUM COPPER BLONDE
BLOND MOYEN CUIVRE
CPEДHЫE KPAЧHЫE C MEДHЫM
OTTEHKOM
LOURO MEDIO ACORREADO
اشقر متوسط نحاسى

Ref. 02002



6.44 ▼

RUBIO OSCURO COBRE INTENSO
DARK INTENSE COPPER BLONDE
BLOND FONCE CUIVRE INTENSE
TEMNYI KPAЧHЫE C KPAHO MEДHЫM
OTTEHKOM
LOURO ESCURO ACORREADO INTENSO
اشقر داكن نحاسى قوى

Ref. 01002



6.4 ▼

RUBIO OSCURO COBRE
DARK COPPER BLONDE
BLOND FONCE CUIVRE
TEMNYI KPAЧHЫE C MEДHЫM
OTTEHKOM
LOURO ESCURO ACORREADO
اشقر داكن نحاسى



CERAS VEGETALES
VEGETABLE WAXES



FANTASÍA
FANTASY · FANTAISIE · ФАНТАЗИЯ · FANTASIA · قوس قزح

APLICACIÓN DIRECTA SIN OXIDACIÓN · DIRECT APPLICATION WITHOUT OXIDATION
APPLICATION DIRECTE SANS OXYDATION · SPRAWDY ZPRAWIENIE BEZ NIECIELENIA
APLICACÃO DIRETA SEM OXIDAÇÃO · سبندى بدون اوكسجى

Ref. 04442



B.0 ▼

BLANCO
WHITE
BLANC
BIAVO
BIANCO
ابى

Ref. 04443



B.8 ▼

ROSA
PINK
ROSE
POCOPAR
ROSA
روزى

Ref. 04444



B.5 ▼

OCLAMEN
CYCLAMEN
CYCLAMEN
ЦИКЛАМЕН
CYCLAMEN
سجىن بومى زىبات چىسى

Ref. 04445



B.7 ▼

GRAPE
GRAPPE
RA/SIN
BИHOПAД
UVA
غرىبى

Ref. 04446



B.6 ▼

AZUL
BLUE
BLEU
CИHЫЙ
AZUL
ازرق

Ref. 04447



B.3 ▼

AMARILLO
YELLOW
JAUNE
ЖEЛТЫЙ
AMARELO
اصفر

Nuancier de couleurs de cheveux
Carta tinturas



REF.04581/4



Échantillons colorations + nuances imprimés
Carta tinturas + matizadores impressa



REF.EM49325



Crème oxydante 20 vol. Creme oxidante 20 vol.

Lavage à sec rapide et agréable
Limpeza a seco rápido e cómodo

NEW



75 ml

20 vol

REF. 07160

Oxydant en crème Creme oxidante



Grâce à sa texture crémeuse et à ses composants (extraits végétaux et huiles naturelles). Plus facile à émulsionner et à étaler sur les cheveux, tout en étant beaucoup plus respectueux avec la fibre capillaire. Laissant les cheveux doux et soyeux.

Grças à sua textura cremosa e aos seus componentes (extratos vegetais e óleos naturais), é mais fácil de misturar e espalhar sobre o cabelo, sendo por sua vez muito menos agressivo com a fibra capilar, deixando o cabelo suave e tratado.

Parfum de pomme
Perfume de maçã

150 ml

10 vol

REF. 04336

20 vol

REF. 04209

30 vol

REF. 04210

40 vol

REF. 04211



Parfum de pomme
Perfume de maçã



1L

10 vol

REF. 04337

20 vol

REF. 04067



30 vol

REF. 04068

40 vol

REF. 04069

Oxydant en crème

Creme oxidante

» Parfum de pomme
» Perfume de maçã

1 u.m.vta
2 box

5L

10 vol

REF.04438

20 vol

REF.04439

30 vol

REF.04440

40 vol

REF.04441



Oxydant en crème

Creme oxidante

1 u.m.vta
6 box

1L

La composition innovante d'OXY BRIGHT BLUE à la texture légère et fluide est particulièrement recommandée pour les colorations blondes (à partir du ton 8) et les décolorations. Elle élimine l'effet jaune ou orangé, et conserve la couleur naturelle sans reflets non désirés.

A inovadora fórmula de OXY BRIGHT BLUE de textura leve e fluída, especialmente indicada para pintar de louro (a partir da altura 8) e descolorações. Elimina o efeito amarelo ou laranja mantendo a cor natural sem reflexos não desejados.



10 vol

REF. 07153

20 vol

REF. 06632

30 vol

REF. 06633

40 vol

REF. 06634

Boîte coloration cheveux contenant 6 couleurs fantaisie**Caixa coloração: 6 cores fantasia**

Boîte coloration cheveux contenant 6 couleurs fantaisie. Elle est appliquée directement sur les cheveux. Découvrez toutes les combinaisons que vous pouvez faire en mélangeant l'une de nos couleurs avec du blanc. Vous obtiendrez une large gamme de tons pastel, vous pouvez les combiner les uns avec les autres et vous pouvez également les utiliser directement sur les cheveux.

Caixa coloração: 6 cores fantasia. Aplica-se diretamente sobre o cabelo. Descubra todas as combinações que pode fazer apenas misturando as nossas cores com branco. Obterá uma ampla gama de tons pastel, pode combiná-los entre si e além disso pode aplicá-los diretamente no cabelo.

» Coloration douce et hydratante.

» Suave e hidratante.

100 gr

REF.04611



Pas besoin oxydant
Não precisa oxidante

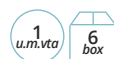

B-0 ○

REF. 04442

B-3 ●

REF. 04447

B-5 ●

REF. 04444

B-6 ●

REF. 04446

B-7 ●

REF. 04445

B-8 ●

REF. 04443

*Convient uniquement pour mélanges et solutions · Apenas adequado para misturas e soluções

Huile protection teinture Óleo protetor corante



Le alpha - bisabolol diminue le risque de sensibilisation et d'irritabilité de la peau et, avec les vitamines E, C et la lécithine de soja, protège la peau de l'oxydation. Crée une barrière protectrice afin que le colorant ne tache pas la peau..

O α - bisabolol diminui o risco de sensibilização e irritabilidade da pele, e juntamente com as vitaminas E, C e a lecitina de soja protegem a pele da oxidação. Cria uma barreira protetora para que a tintura não manche a pele..

120
u.m.vta

120
box

3 ml

REF.03929



1
u.m.vta

6
box

150 ml

REF.06282



Huile anti-tâches Pacote óleo antimancha

- » Huile protectrice anti-tâches
- » + cape à usage unique
- » + gants

- » Pacote: óleo anti manchas
- » + capa uma só utilização
- » + luvas

100
u.m.vta

100
box

3 ml

REF.03998



Poudre décolorante bleue brillant WILD BRIGHT**Pó descolorante azul WILD BRIGHT**

Grande capacité à faire glisser la couleur, tout en respectant les cheveux. Deux formats pratiques (petits et grands), choisissez celui qui correspond le mieux à vos besoins.

Grande capacidade de descoloração sendo no entanto, cuidadoso com o cabelo. Em dois práticos formatos: pequeno e grande, escolha o que melhor se adapte às suas necessidades.



50

u.m.vta



50

box

25 gr

REF. 04289

» Avec fermeture automatique

» Com fechamento automático



1

u.m.vta



12

box

500 gr

REF.03922

**Poudre décolorante WILD WHITE****Pó descolorante WILD WHITE**

L'huile d'argan et la kératine.

Le blanc sauvage a le même pouvoir blanchissant que le décolorant Wild Bright, la seule différence est qu'il ne contient PAS d'ammoniaque et protège la fibre capillaire grâce à l'huile d'argan et à la kératine.

Óleo de Argão e queratina.

Wild White tem o mesmo poder branqueador que o descolorante Wild Bright, a única diferença é que não contém amoníaco e protege a fibra capilar graças ao óleo de Argão e à Queratina.

Sans ammoniaque**Sem amônia**

50

u.m.vta



50

box

25 gr

REF.03611

» Avec fermeture automatique

» Com fechamento automático



1

u.m.vta



12

box

500 gr

REF.03921



Sachet 500 gr décoloration Deco-plex Embalagem 500 gr escoloração Deco-plex

Plus de protection lors de vos décolorations avec la nouvelle DECO-PLEX aux Algues rouges & aux Acides aminés qui prennent soin de la structure des cheveux. Elle peut éclaircir jusqu'à 8-9 niveaux.

Mais proteção nas suas descolorações com a nova DECO-PLEX, com Algas vermelhas & Aminoácidos que cuidam da estrutura do cabelo. Pode clarear até 8-9 níveis.

NEW



25 gr

REF. 07428

» Avec fermeture automatique
» Com fechamento automático

NEW



500 gr

REF.07201



Decocream Protect TASSEL TASSEL Decocream Protect



Crème Capillaire Décolorante au puissant pouvoir éclaircissant. Sa texture innovante en crème prend plus soin de la peau et des cheveux. Enrichie avec un polymère spécial qui protège les cheveux et réduit leur casse, et en huile de Jojoba qui optimise les propriétés de l'après-shampooing et apporte douceur et brillance. Soin et protection maximale des cheveux.

Creme Descolorante Capilar de elevado poder aclarante. A sua inovadora textura em creme, cuida mais da pele e do cabelo. Enriquecido com um polímero especial que protege o cabelo minimizando a rotura e óleo de Jojoba que melhora as propriedades do amaciador, proporcionando brilho e suavidade. Máximo cuidado e proteção do cabelo.

» À l'huile de jojoba
» Com óleo de jojoba

500 gr

REF.06561





IONI · K TREATMENT



*Pas à pas
con IONI·K
Passo a passo
com IONI·K*

Cheveux réparés en 4 étapes faciles. Traitement des ions et de la kératine qui réparent les cheveux abîmés en profondeur, laissant une apparence plus brillante et plus lisse. Évite les frisottis.

Cabelo reparado em 4 fáceis passos. Tratamento de iões e queratina que reparam os cabelos danificados em profundidade, deixando uma aparência muito mais brilhante e suave. Evite o frizz.

1

**Shampooing
pré- traitement lissant
Shampoo
pré-suavizado**



1
u.m.vta

12
box

500 ml

REF.04949



REF.04997

Traitement de kératine SANS FORMOL

Tratamento de queratina SEM FORMOL



Formulé avec un système ionique innovant, il permet de redonner force et vitalité aux cheveux, de faciliter le défrisage et d'éviter les frisottis. Les cheveux sembleront plus sains, plus doux et plus lumineux.

Formulado com um inovador sistema de íons, permite restaurar e dotar cabelos com força e vitalidade, facilitando o alisamento e evitando o frizz. O cabelo ficará mais saudável, mais suave e mais brilhante.



2

Traitement lissant et anti-frisottis
Tratamento suavizado e anti frizz



500 ml

REF.04951

3

Shampooing post-lissant
Shampoo pós-alisante

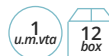

500 ml

REF.04950

4

Masque capillaire d'étaanchéité
Máscara capilar alisado



400 ml

REF.04982

Dry shampoo - shampoing sec en poudre**Dry shampoo - champô seco em pó**

300 ml

REF.07130



Dry Shampoo est un shampoing en poudre qui s'applique en spray (PAS BESOIN D'EAU). Il apporte un volume plus prononcé. Il aide les cheveux à rester propres durant plus longtemps. Idéal pour les cheveux gras, il absorbe l'excès de sébum et matifie la tige capillaire, donnant ainsi un aspect plus propre et sain. Il est également recommandé sur cheveux propres, pour texturiser, donner du volume et faciliter le coiffage. Pour tout type de cheveux.

Dry Shampoo, é um shampoo em pó que se aplica em spray (NÃO NECESSITA DE ÁGUA). Proporciona um volume mais pronunciado. Ajuda a que o cabelo se mantenha limpo durante mais tempo. Ideal para cabelos oleosos, absorve o excesso de gordura, matificando o cabelo e proporcionando um aspeto mais limpo e saudável. Também é recomendável para cabelos recém-lavados, para texturizar, dar volume e facilitar o pentear. Para todos os tipos de cabelo.

Hyaluronic shampoo TASSEL
Hyaluronic shampoo TASSEL**Bienfaits**

- » Lavage doux
- » Hydratation profonde
- » Restructuration des cheveux

Qu'est-ce que c'est ?

Enrichi en Acide Hyaluronique. Effet Anti-Âge. Lavage doux et hydratation profonde des cheveux. Il restructure les cheveux abîmés et cassants, et leur rend leur élasticité. Il hydrate et adoucit les cheveux.

Benefícios

- » Limpeza suave
- » Hidratação Profunda
- » Reestrutura o cabelo

O que é?

Enriquecido com Ácido Hialurónico. Efeito Anti-Aging. Limpeza suave e hidratação profunda do cabelo. Reestrutura o cabelo danificado e quebradiço devolvendo-lhe a elasticidade. Hidrata e suaviza o cabelo.



NEW

1 L

REF.07379

**Hyaluronic mask TASSEL**
Hyaluronic mask TASSEL**Bienfaits**

- » Hydratation
- » Douceur
- » Réparation
- » Prévention de la cassure des cheveux

Qu'est-ce que c'est ?

Enrichi en Acide Hyaluronique. Effet Anti-Âge. Il hydrate et adoucit les cheveux.

Il apporte une hydratation intense grâce à l'acide hyaluronique. Il répare et prévient la cassure et l'apparition des fourches. Il adoucit et rend les cheveux flexibles.

Benefícios

- » Hidrata
- » Suaviza
- » Repara
- » Previne a rotura do cabelo

O que é?

Enriquecido com Ácido Hialurónico. Efeito Anti-Aging. Hidrata e suaviza o cabelo.

Proporciona uma hidratação intensa graças ao ácido hialurónico. Repara e previne a rotura e as pontas abertas. Suaviza e flexibiliza o cabelo.

NEW

1 L

REF.07380

**Hyaluronic SPLASH**
Hyaluronic SPLASH

Enrichi en acide hyaluronique qui, grâce à ses propriétés, améliore le cheveu en lui donnant une sensation d'hydratation profonde, de remplissage et d'élasticité, évitant les frisottis, lui donnant brillance et texture soyeuse. Unissant celles de l'huile d'argan, des protéines de soie et de la kératine, elles forment un excellent cheveu anti-âge.

Enriquecido com Ácido Hialurónico que, graças às suas propriedades, melhora os cabelos conferindo-lhes uma sensação de hidratação profunda, enchimento e elasticidade, evitando o frizz, conferindo-lhes brilho e textura sedosa. Unindo as propriedades do Óleo de Argan, Proteínas da Seda e Queratina, formam um excelente Anti-envelhecimento para o cabelo.

NEW

1 L

REF.07438



Shampooing prévention anti-chute Champô prevenção da queda

- » Shampooing formulé spécifiquement pour lutter contre la chute des cheveux, car il combine des protéines et des bionutriments d'origine végétale, qui agissent comme des décongestionnants et des revitalisants, tout en évitant ainsi les irritations.
 - » Nettoie en profondeur, en éliminant les graisses qui se forment sur le cuir chevelu, permettant ainsi aux nouveaux cheveux de se développer sans entrave.
 - » Les cheveux sont doux, brillants et soyeux.
- » Champô formulado especificamente para combater a queda de cabelo, visto que combina proteínas e bio-nutrientes de origem vegetal, que atuam com descongestionante e revitalizante evitando assim a irritação.*
- » Limpa em profundidade, eliminando a oleosidade que se forma no couro cabeludo permitindo assim que o cabelo cresça naturalmente.*
- » O cabelo fica suave, brilhante e sedoso.*



1 u.m.vta 12 box

1 L

REF.03566

1 u.m.vta 6 box

400 ml

REF.03553

Ampoules Ampolas

Les meilleurs nutriments pour le cuir chevelu et sont des protéines d'origine végétale. Ils améliorent l'absorption de ceux-ci et favorisent l'oxygénation du follicule pileux, en réduisant ainsi la perte de cheveux. Les nutriments végétaux agissent également comme décongestionnants et revitalisants, en empêchant ainsi l'irritation. La kératine répare et fortifie les cheveux, leur donnant du volume et de la brillance.

Os melhores nutrientes para o couro cabeludo são as proteínas de origem vegetal. Aumentam a absorção destes e favorecem a oxigenação do folículo piloso, diminuindo assim a queda do cabelo. Os nutrientes vegetais também atuam como descongestionantes e revitalizantes, evitando assim a irritação. A queratina repara e fortalece o cabelo, dando-lhe volume e brilho.

PACK prévention anti-chute

12 ampoules (10 ml) prévention anti-chute

- » + shampooing prévention anti-chute 400 ml

PACOTE de prevenção queda

- » 12 ampolas (10 ml) prevenção queda
- » + champô de prevenção 400 ml

1 u.m.vta 6 box

10 ml

REF.03550

» 12 ampoules (10 ml) prévention anti-chute

» 12 ampolas (10 ml) prevenção queda

1 u.m.vta 50 box

10 ml

REF.03551



Crème adoucissante aux HERBES Conditionneur HERBAL

1 u.m.vta
12 box

Conditionneur d'extraits végétaux qui réparent, renforcent et préviennent la desquamation de la fibre capillaire. Ces extraits apportent aux cheveux douceur, brillance et luminosité, favorisant la coiffure.

Conditionador de extratos vegetais que reparam, fortalecem e previnem a descamação da fibra capilar. Estes extratos dão suavidade, brilho e luminosidade ao cabelo, favorecendo o seu penteado.



1 L

REF.03555

Shampooing NEUTRE Champô NEUTRO

1 u.m.vta
12 box

Shampooing pour tous les types de cheveux et particulièrement indiqué pour une utilisation quotidienne ou fréquente. Il lave les cheveux d'une manière douce et maintient le PH. Il Protège le cuir chevelu, en donnant l'équilibre et la santé aux cheveux.

Champô para todo o tipo de cabelo e especialmente indicado para o uso frequente. Lava o cabelo de uma forma suave e mantém o PH. Protege o couro cabeludo, dando-lhe equilíbrio e saúde ao cabelo.



1 L

REF.03556

» Utilisation fréquente
» Uso frequente

Shampooing PROTECTION COULEUR Champô PROTECT COLOR

Shampooing spécifique pour les cheveux teints ou colorés. Il ravive et retient la couleur des cheveux plus longtemps. Il Fournit un aspect doux, lumineux et brillant. Un shampooing au PH acide.

Champô indicado para cabelos pintados ou com madeixas. Revive e mantém a cor do cabelo durante mais tempo. Dando-lhe um aspeto suave, brilhante e luminoso. PH ácido.

1 u.m.vta
500 box

10 ml

REF.06806



1 u.m.vta
12 box

1 L

REF.04620



1 u.m.vta
600 box

10 ml

REF.06659



1 u.m.vta
12 box

500 ml

REF.06563



NEW
1 u.m.vta
12 box

500 ml

REF.07429



Shampooing nutrition**Champô nutritivo**

Shampooing avec des protéines et des bionutriments d'absorption facile et d'incorporation rapide à la structure capillaire. Il contient de la kératine qui nourrit, répare et régénère la cuticule capillaire et diminue la tendance à former des pointes fourchues, la protégeant des agressions extérieures. Le résultat est plus de cheveux renforcés, avec plus de volume et plus de brillance.

Champô com proteínas e bio-nutrientes de fácil absorção e rápida incorporação na estrutura capilar. Contém queratina que nutre, repara e regenera a cutícula do cabelo e diminui a tendência à formação de pontas espigadas, protegendo-o das agressões externas. O resultado é um cabelo forte, com mais volume e mais brilho.



1 u.m.vta 500 box

10 ml

REF.06804



1 u.m.vta 12 box

1 L

REF.03552

Ligne de restructuration ARGAN**Linha de reestruturação ARGAN**

TASSEL crée la Nouvelle Ligne Argan, conçue pour le traitement en profondeur des cheveux. Elle restructure la fibre capillaire et apporte aux cheveux un aspect brillant et régénéré.

A TASSEL cria a Nova Linha Argan, concebida para o tratamento em profundidade dos cabelos. Reestrutura a fibra capilar e confere-lhe um aspecto brilhante e regenerado.

NEW



1 u.m.vta 12 box

500 ml

REF.07165

NEW



1 u.m.vta 12 box

250 ml

REF.07167

NEW



1 u.m.vta 12 box

50 ml

REF.07166

**Shampooing
Shampoo**

Aide à la régénération des cheveux et du cuir chevelu et optimise la croissance des cheveux. Hydrate et élimine les frisottis. Apporte aux cheveux plus de corps et de brillance. Lutte contre la fragilité et la cassure.

Este shampoo ajuda a regenerar o cabelo e couro cabeludo com um efeito positivo no crescimento do cabelo. Hidrata e suaviza o frizz. Dá mais corpo e brilho aos cabelos. Combate a fragilidade e quebra.

**Baume
Bálamo**

Nutrition intense de la racine jusqu'aux pointes et y compris du cuir chevelu. Conditionneur profond et hydratant. Réparation et restauration de la fibre capillaire. Idéal pour les cheveux secs et abîmés.

Nutrição intensa da raiz às pontas, passando pelo couro cabeludo. Condicionamento e hidratação profunda. Reparação e Restauração da fibra capilar. Ideal para cabelos secos e danificados.

**Sérum
Sérum**

Répare et conditionne les cheveux. Élimine instantanément les frisottis. Sérum fortifiant, fonctionne de l'intérieur vers l'extérieur pour réparer les cheveux abîmés et cassants.

Repara e condiciona o cabelo. Elimine o frizz instantaneamente. Soro Fortalecedor, atua de dentro para fora para reparar cabelos danificados e quebrados.

Shampooing fortifiant à la biotine et à la kératine Champô fortificante com biotina e queratina

Shampooing et masque spécialement formulés avec de la biotine (vitamine h) et de la kératine. La biotine prévient la sécrétion sébacée et la chute des cheveux, elle réactive la croissance en donnant force et épaisseur aux cheveux. La kératine nourrit, répare et régénère la cuticule capillaire et diminue la tendance à former des pointes fourchues. Le résultat est plus de cheveux renforcés, avec plus de volume et plus de brillance. PH 5.5.

Champô e máscara especialmente concebida com biotina (vitamina H) e queratina. A biotina evita a secreção sebácea e a queda de cabelo, promove o crescimento dando-lhe força e espessura ao cabelo. A queratina nutre, repara e regenera a cutícula do cabelo e diminui a tendência a formar pontas espiçadas. O resultado é um cabelo mais forte, com mais volume e mais brilho. PH 5.5.



1 u.m.vta
12 box

1 L

REF.03663

Masque fortifiant Máscara fortificante

» A la biotine et à la kératine

1 u.m.vta
6 box

» Com biotina e queratina

500 ml

REF.03674

1 u.m.vta
500 box

10 ml

REF.06805



Shampooing CHLOROPHYLLE Champô CLOROFILA

1 u.m.vta
2 box

5 L

REF.04324



Formulé pour laver doucement et soigneusement tous les types de cheveux, adapté pour une utilisation fréquente. Il donne aux cheveux plus de brillance, une apparence plus saine et une agréable odeur de menthe.

Formulado para lavar suavemente e em profundidade todo o tipo de cabelos com frequência. Dá ao cabelo mais brilho, um aspeto mais saudável e um agradável cheiro a menta.

Shampooing NEUTRE Champô NEUTRO

1 u.m.vta
2 box

5 L

REF.04325



Shampooing pour tous les types de cheveux, particulièrement adapté pour une utilisation quotidienne ou fréquente. Il lave les cheveux d'une manière douce et maintient le pH de la cuticule. Il protège le cuir chevelu en lui donnant l'équilibre et la santé.

Champô para todo o tipo de cabelos, especialmente indicado para uso diário ou frequente. Lava o cabelo de uma forma suave e mantém o PH da cutícula do mesmo. Protege o couro cabeludo dando-lhe equilíbrio e saúde.

Crème ADOUCISSANTE CONDICIONADOR

1 u.m.vta
2 box

5 L

REF.04326



Conditionneur avec des extraits de plantes qui réparent, renforcent et empêchent la desquamation de la fibre capillaire. Ces extraits donnent aux cheveux douceur, brillance et luminosité, favorisant la coiffure.

Com extratos vegetais que reparam, fortalecem e previnem a descamação da fibra capilar. Estes extratos dão ao cabelo suavidade, brilho e luminosidade, favorecendo o penteado.

Baume adoucissant HERBAL Bálsamo suavizante HERBAL

Il possède un grand pouvoir adoucissant et démêlant. Il restaure l'équilibre naturel des cheveux et leur rend un aspect sain et naturel. Il contient des ingrédients conditionneurs et un arôme herbal. Sans parabens ni silicones.

Possui um grande poder de suavizar e desembaraçar. Restaura o equilíbrio natural do cabelo, devolvendo o seu aspeto saudável e natural. Contém ingredientes amaciadores e um aroma herbal. Sem parabenos nem silicones.



5 L

REF.06682

Masque de cheveux bright color Máscara bright color

Enrichi en huile d'argan, en kératine et en collagène qui restructurent et nourrissent les cheveux secs et déshydratés offrant brillance et douceur. Il répare les dégâts causés par les attaques thermiques et le protège contre les ruptures.

Enriquecido com Óleo de Argan, queratina e colágeno que reestrutura e nutre o cabelo seco e desidratado, oferecendo brilho e maciez. Repara os danos causados por ataques térmicos e protege-os contra quebras.



400 ml

REF.06313

Shampoing 5 litres intense bright colour Shampoo 5 litros intense bright colour

SHAMPOING INTENSE BRIGHT COLOUR, complément de la Ligne de produits techniques TASSEL, Enrichi en Huile d'Argan et en Kératine. Spécialement recommandé pour les cheveux secs, colorés et décolorés, aux propriétés hydratantes, restructurantes et réparatrices de la fibre capillaire. Le complément idéal de notre NOUVEAU MASQUE CAPILLAIRE BRIGHT MASK réparateur à l'Huile d'Argan et à la Kératine.

SHAMPOO INTENSE BRIGHT COLOUR, complemento da Linha de produtos técnicos da TASSEL, Enriquecido com Óleo de Argão e Queratina. Especialmente indicado para cabelos secos, pintados e descolorados e com propriedades hidratantes, reestruturantes e reparadoras da fibra capilar. O complemento ideal, a nossa NOVA MÁSCARA CAPILAR BRIGHT MASK reparadora com Óleo de Argão e Queratina.

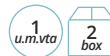

5 L

REF.06336

Doseur Doseador

» Dose 30 ml à chaque pression de shampoing
» Bidons de 5 litres.

*» Dosear 30 ml a cada prensa de xampu
» Garrações de 5 litros.*



REF.07093

Shampoings 5 litres "parfum sensation" Shampoos 5 litros "aroma sensation"

TASSEL, avec son caractère innovant constant, lance, élargit et renouvelle sa Ligne de Shampoings en bidon. Avec cela, la marque souhaite répondre aux besoins du marché. SHAMPOING NEUTRE avec un agréable parfum de MELON, FRAISE et NOIX DE COCO. Tout cela élaboré pour obtenir un lavage en profondeur des cheveux et du cuir chevelu. Sa concentration élevée en matière active permet un lavage parfait. Il apporte aux cheveux plus de brillance, un aspect plus sain. Usage quotidien. Ph. 5,5.

TASSEL, com o seu carácter de inovação constante, lança, amplia e renova a sua Linha de Shampoos a granel. Assim, pretende cobrir as necessidades de mercado. SHAMPOO NEUTRO com um agradável cheiro a MELÃO, MORANGO e COCO. Todos estes formulados para conseguirem uma lavagem profunda do cabelo e do couro cabeludo. A sua elevada concentração de matéria ativa permite uma lavagem perfeita. Proporciona ao cabelo mais brilho, um aspeto mais saudável. De utilização diária. Ph. 5,5.



REF.07199

REF.06337



REF.07200

REF.06338



REF.07198

REF.06339

Melon
Melão



Fraise
Morango



Noix de coco
Coco



Masque capillaire avec collagène 1L Máscara capilar com colagénio 1L

Melon
Melão

1 L

REF.06450



Fraise
Morango

1 L

REF.06448



Noix de coco
Coco

1 L

REF.06449



Shampoings 5 litres "parfum sensation" Caixa com 12 traitements Wow Effect



Avec Kératine, Huile d'Argan et Soie Capillaire.
Traitement enrichi avec :

- » **Kératine** qui augmente le soyeux des cheveux, hydrate en profondeur, intensifie la brillance et scelle les fourches. Elle permet de conserver la couleur plus longtemps et améliore la santé capillaire.
- » **Protéines de Soie** qui hydratent en profondeur, revitalisent les cheveux abîmés et apportent de la brillance.
- » **Huile d'Argan** qui répare, restructure les cheveux abîmés par les agressions externes, adoucie, nourrit et hydrate

Com Queratina, Óleo de Argão e Seda Capilar.

Treatmento enriquecido com:

- » **Queratina**, que aumenta a sedosidade do cabelo o que produz uma hidratação profunda, intensifica o brilho e ajuda a selar as pontas abertas. Mantém a cor e melhora a saúde capilar.
- » **Proteínas de Seda**, que hidratam em profundidade, revitalizam o cabelo pintado e proporcionam brilho.
- » **Óleo de Argão**, que repara, reestrutura o cabelo danificado por agressões externas, suaviza, nutre e hidrata.



NEW

REF.07244



Explosion réparatrice pour cheveux en 5 min Explosão reparadora para o cabelo em 5 min

Explosion réparatrice pour cheveux en 5 min. Sachet 1 **Effet Flash** + sachet 2 **Effet Impact**. Mélanger les 2 sachets et créer l'**EXPLOSION RÉPARATRICE**. Des cheveux sains en une seule application.

MODE D'EMPLOI: Mélanger le contenu des deux sachets dans un bol non métallique jusqu'à obtenir une émulsion homogène. Appliquer sur les cheveux de la racine jusqu'aux pointes et masser. Laisser agir entre 5 et 10 minutes selon l'état des cheveux et rincer à l'eau claire.

Explosão reparadora para o cabelo em 5 min. Pacote 1 **Efeito Flash** + pacote 2 **Efeito Impact**. Misture os 2 pacotes e gere a **EXPLOÇÃO REPARADORA**. Recupere a saúde do seu cabelo com uma só aplicação.

MODO DE EMPREGO: Misturar o conteúdo de ambos os pacotes num recipiente não metálico até obter uma emulsão homogênea. Aplicar massajando o cabelo da raiz até às pontas. Deixar atuar entre 5 e 10 minutos dependendo do estado do cabelo e passar por água.

Masque nutrition avec kératine Máscara de nutrição com queratina

Formulé avec de la kératine qui nourrit, conditionne et augmente l'élasticité des cheveux, en leur réparant de la racine aux pointes, les protège des agressions extérieures et diminue la tendance à former des pointes fourchues.

Fórmula com queratina que nutre, condiciona e aumenta a elasticidade do cabelo, reparando-o desde a raiz até às pontas, protege-o das agressões externas e diminui a tendência a formar pontas espiçadas.



100 ml

REF.03435



500 ml

REF.06948

Kit de plage kératine Kit de praia com queratina

Kit de plage composé d'un écran solaire capillaire, d'un masque nourrissant, d'une brosse à soufflet en bois, d'un large peigne à dents en plastique, d'une pince à cheveux, d'une pince à sourcils et d'un double miroir avec petit peigne.

Kit de praia composto por protetor solar capilar, máscara nutritiva, escova de madeira, pente de plástico com dentes largos, mola para o cabelo, pinças para depilar as sobrancelhas e espelho duplo com pente pequeno.



REF.03519



BI-PHASIC Tassel BI-PHASIC Tassel

Bienfaits

- » Hydratation
- » Flexibilité
- » Douceur
- » Volumateur et conditionneur

Qu'est-ce que c'est ?

Enrichi en Lin qui apporte aux cheveux hydratation, flexibilité et douceur, ainsi qu'en protéines de Blé, qui possèdent des effets similaires à ceux de la kératine. Il rend les cheveux plus élastiques et plus volumineux, et agit comme un conditionneur naturel. Spécialement conçu pour cheveux secs et abîmés.

Benefícios

- » Hidratação
- » Flexibilidade
- » Suavidade
- » Proporciona Volume e Amacia

O que é?

Enriquecido com Linhaça que proporciona ao cabelo hidratação, flexibilidade e suavidade assim como proteínas de trigo, que possuem efeitos similares à queratina. Faz com que o cabelo seja mais elástico, com mais volume e atua como um amaciador natural. Especificamente para cabelos secos e danificados.



500 ml

REF.07369

NEW



Protecteur thermique Protetor térmico

Anti-crêpage
Desfrisagem



250 ml

REF.03343



Activateur de boucles Ativador de caracóis



250 ml

REF.03344



Kératine liquide Queratina líquida



250 ml

REF.03554



Formulation spécifique pour la protection et le soin des cheveux contre les agressions produites par les dispositifs de séchage qui génèrent de la chaleur, tels que les sècheurs, le fer à lisser et le fer à boucler. Son conditionneur empêche les frisottis, laissant les cheveux plus maniables et brillants en évitant l'effet antistatique.

Fórmula específica para proteger e cuidar o cabelo ante as agressões produzidas pelos aparelhos de secagem, que geram calor, tais como secadores, as pranchas alisadoras e ferros de frisar. O seu condicionador evita o frisado, deixando o cabelo mais maleável e brilhante, evitando o efeito anti estático.

Sa formule innovante crée une pellicule qui renforce et revitalise les boucles, en leur donnant plus de définition, plus d'élasticité et d'hydratation sans alourdir. Son effet conditionnant apporte volume et épaisseur, laissant aux cheveux un aspect soyeux, brillant et vaporeux.

A sua fórmula inovadora cria uma película que reforça e revitaliza os caracóis, dando-lhes mais definição, mais elasticidade e hidratando-os sem deixar o cabelo pesado. O seu efeito condicionador dá volume e espessura, deixando o cabelo com um aspeto sedoso, brilhante e solto.

La kératine liquide nourrit, répare et régénère instantanément la cuticule capillaire. Elle contient des protéines de collagène et de soie, qui procurent un effet revitalisant, pour une chevelure plus saine et plus forte et une amélioration du volume, de la douceur et de la brillance.

A queratina líquida nutre, repara e regenera a cutícula do cabelo instantaneamente. Contém colagénio e proteínas de seda, que têm um efeito condicionador, conseguindo um cabelo mais saudável, mais forte e melhorando o volume, suavidade e brilho.

Lovely Curls Tassel Lovely Curls Tassel

Bienfaits

- » Contrôle des boucles
- » Hydratation maximale
- » Volume
- » Mouvement naturel des cheveux

Qu'est-ce que c'est ?

Conditionneur en crème qui définit les boucles. Il contient du Panthénol et des Protéines de Blé. Il élimine les frisottis et apporte un contrôle des boucles. Hydratation maximale, volume et mouvement naturel des cheveux.

Benefícios

- » Controlo dos caracóis
- » Máxima Hidratação
- » Volume
- » Movimento Natural ao cabelo

O que é?

Creme amaciador que define os caracóis. Contém Panthenol e Proteínas de Trigo. Elimina o cabelo frisado e proporciona controlo dos caracóis. Máxima hidratação, volume e movimento ao seu cabelo.



250 ml

REF.07381

NEW



Sérum all for hair

Sérum all for hair

Sérum protecteur des cheveux, avec kératine, filtre UV, huile d'argan et protéines de soie. Sans rinçage.
 Sérum protetor do cabelo, com queratina, filtro UV, óleo de argão e proteínas de seda. Sem enxaguamento

10 avantages en une seules application:

1. Répare les cheveux endommagés
2. Apporte brillance
3. Protecteur thermique
4. Adoucit et démêle
5. Protection UV
6. Prévient des frisottis
7. Empêche pointes fourchues
8. Fournit le volume
9. Facilite la coiffure
10. Hydrate en profondeur

10 benefícios numa só aplicação:

1. Repara o cabelo danificado
2. Dá brilho
3. Protetor térmico
4. Suaviza e desembaraça
5. Proteção UV
6. Evita o cabelo frisado
7. Previne pontas espigadas
8. Dá volume
9. Facilita o penteado
10. Hidrata em profundidade

120
u.m.vta

120
box

3 ml

REF.03930

1
u.m.vta

12
box

250 ml

REF.03830



Poudres volumisantes

Pós volumosos

Poudre ultra-légère pour texturer. Doux et avec effet mat. Tenez les cheveux et ajoutez du volume même dans les cheveux fins. Le plus vous appliquez le plus de contrôle que vous obtenez avec une fixation incroyable. Pour un effet mat plus intense, appliquez sur cheveux humides, en le modelant et en le laissant sécher. Vous pouvez également appliquer sur les cheveux secs pour obtenir un contrôle supplémentaire des frisottis et plus de douceur. Enrichi en kératine qui favorise la résistance de la kératine capillaire.

Pó de cobertura ultra-leve para texturização. Macio e com efeito mate. Segure o cabelo e adicione volume mesmo em cabelos finos. Quanto mais você aplicar, mais controle terá com uma fixação incrível. Para um efeito mate mais intenso, aplique nos cabelos úmidos, moldando-os e deixando secar. Também pode aplicar no cabelo seco para obter controle adicional de frizz e mais suavidade. Enriquecido com queratina que favorece a resistência da queratina capilar.



1
u.m.vta

15
box

10 gr

REF. 06316

1
u.m.vta

20
box

20 gr

REF. 06175



Retoucher les racines
Retoque raízes

Coloration temporaire en spray.

- » Couleur instantanée. Couvre instantanément les racines et les cheveux gris, se fondant parfaitement avec votre couleur. Séchage rapide et visible sur tous les cheveux. S'en va après 1 ou 2 lavages.
- » Couvre les racines et les cheveux gris
- » Coloration temporaire
- » Séchage rapide

MODE D'UTILISATION

PRÉPARATION: Placez une serviette sur les épaules.

- » Agitez bien et gardez le récipient à la verticale. Vaporiser à environ 15 cm des cheveux secs. Ne pas trop vaporiser, une petite quantité suffit. Laisser sécher 1 minute et peigner. Vaporisez une seconde fois pour une couleur plus intense.
- » Après avoir pulvérisé les racines, utilisez un peigne pour répartir le produit de vos racines sur environ 4 ou 5 centimètres sur la longueur, vous obtiendrez ainsi un résultat plus naturel.

Coloração por spray temporária.

Cor instantânea. Cobre raízes e cabelos grisalhos instantaneamente, combinando perfeitamente com sua cor. Secagem rápida, visível em todos os cabelos. Pode ser removido com 1 ou 2 lavagens.

- » Cobre raízes e cabelos grisalhos
- » Coloração temporária
- » Secagem rápida

NEW**MODO DE USO**

PREPARAÇÃO: Coloque uma toalha sobre os ombros.

- » Agite bem e mantenha o recipiente na posição vertical. Pulverize cerca de 15 cm do cabelo seco. Não vaporize demais, uma pequena quantidade é suficiente. Deixe secar por 1 minuto e penteie. Pulverize uma segunda vez para obter uma cor mais intensa.
- » Depois de colorir as raízes, use um pente para distribuir o produto, desde as raízes cerca de 4 ou 5 centímetros no comprimento do cabelo, para obter um resultado mais natural.



REF.07277/50

Noire
Preto

REF.07277/67

Brun foncé
Castanho escuro

REF.07277/65

Châtain clair
Castanho claro

REF.07277/66

Blond foncé
Loiro escuro

REF.07277/76

Blond clair
Loiro claro

REF.07277/60

Rouge
Vermelho

Fibre capillaire
Fibra capilar

22 gr

- » Avec distributeur
- » Pour hommes et femmes. Idéales pour la perte de densité capillaire. Elles dissimulent les zones ayant peu de cheveux, rapidement et naturellement
- » Elles adhèrent aux cheveux et leur apportent volume et épaisseur
- » Faciles à appliquer, en agitant le pot au-dessus de la zone d'application
- » Disponibles en 6 couleurs : Noir, Châtain Foncé, Châtain Moyen, Châtain Clair, Blond Foncé et Gris Clair qui s'adaptent à la couleur naturelle des cheveux

- » Para homem e mulher. Ideal para a perda de densidade capilar. Dissimula as zonas com pouco cabelo, de forma rápida e natural
- » Adere ao cabelo conferindo-lhe mais volume e espessura
- » Aplica-se facilmente, agitando o frasco em cima da zona de aplicação
- » Disponível em 6 cores: cor preto, Castanho Escuro, Castanho Médio, Castanho Claro, Louro Escuro e Cinzento Claro que se adaptam à tonalidade da cor natural do cabelo
- » Com dispensador



Noire · Preto

REF.06436/50



Gris clair · Cinza claro

REF.06436/72



Blond foncé · Loiro escuro

REF.06436/66

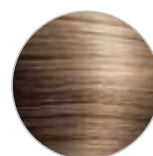

Brun foncé · Castanho escuro

REF.06436/67

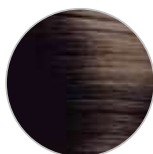

Châtaignier moyen · Castanha média

REF.06436/76

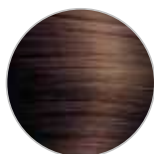

Châtain clair · Castanho claro

REF.06436/65

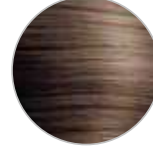
**Pulvérisateur de fibres capillaires**
Pulverizador de fibra capilar

REF.07208

NEW

- » Facile d'utilisation
- » Permet une distribution plus uniforme des fibres capillaires sur les zones spécifiques.
- » Permet aux fibres d'adhérer aux cheveux naturels beaucoup plus facilement. Moins de produit est nécessaire pour obtenir le look souhaité.
- » Facile à conserver

MODE D'EMPLOI :

Verser les fibres capillaires dans la bouteille en verre et positionner le pulvérisateur pour les pulvériser. Appuyer pour cela la pompe de haut en bas.

- » Fácil de usar
- » Permite uma distribuição mais uniforme das fibras capilares em áreas específicas.
- » Ele permite que as fibras se fixem em seu cabelo natural com muito mais facilidade. É necessária menos quantidade de produto para obter a aparência desejada.
- » Fácil de guardar

COMO USAR:

Despeje as fibras capilares no frasco de vidro e instale o atomizador para borrifá-las. Pressione a bomba para cima e para baixo para este propósito.



Laque fibre capillaire
Laca fibra capilar



Pour une fixation et une fixation maximales des fibres
 Para máxima fixação das fibras

100 ml

REF.06649



Présentoir fibres capillaires (en cadeau)
Expositor fibras capilares (de oferta)



Il inclue 6 tons de fibres capillaires + laque de fixation

- » Réf. 06436/50 Noir 22 g.- Réf. 06436/72 Gris clair 22 g. - Réf. 06436/66 Blond foncé 22 g. - Réf. 06436/67 Châtain foncé 22 g. - Réf. 06436/76 Châtain moyen 22 g. - Réf. 06436/65 Châtain clair 22 g.
- » Réf. 06649 Laque fixation fibres capillaires 100 ml.

» Inclui 6 tons fibras capilares + laca fixação

- » Ref. 06436/50 Preto 22 g. - Ref. 06436/72 Cinzento claro 22 g. - Ref. 06436/66 Louro escuro 22 g. - Ref. 06436/67 Castanho escuro 22 g. - Ref. 06436/76 Castanho médio 22 g. - Ref. 06436/65 Castanho claro 22 g.
- » Ref. 06649 Laca fixação fibras capilares 100 ml.



NEW

REF.07801

Laques Tassel Cosmetics, idéales pour chignons
Lacas da Tassel Cosmetics, ideal para updos



» Normale
 » Normal



300 ml

REF.06268

750 ml

REF.06265

» Forte
 » Forte



300 ml

REF.06269

750 ml

REF.06266

Industrias Oriol 1942, SL lance la nouvelle gamme de finitions "LAQUES CAPILARES TASSEL", enrichie en huile d'argan, actif riche en acides gras établis, en vitamine E, ainsi qu'en bêta-caroténoïdes, offrant une capacité d'hydratation élevée et préservant les cheveux en leur donnant une brillance et une beauté naturelles

Sa composition actualisée, très substantive des cheveux, permet des vaporisations plus rationnelles et forme une pellicule plus flexible et élastique capable de protéger les cheveux des agents externes tels que le vent ou l'humidité, permettant de conserver ainsi n'importe quel type de coiffure avec la brillance, le volume et le soyeux souhaités grâce à son composant Huile d'Argan.

Son EFFET LONG LASTING la rend idéale pour lisser, friser, donner du volume, les chignons, créer des coiffures infinies et conserver durant toute la journée de manière naturelle et sans alourdir, la coiffure. Sa composition permet une élimination facile par un léger brossage. Elle ne laisse pas de résidus.

Industrias Oriol 1942, SL lança no mercado a nova linha de "LACAS CAPILARES TASSEL", enriquecida com óleo de argão, rico em ácidos graxos, vitamina E, além de beta-carotenóides. Proporcionando alta capacidade de hidratação e preservando os cabelos, brilho e beleza natural

A sua fórmula atualizada, que nutre o cabelo, permite vaporizados mais racionais e forma uma película mais flexível e elástica capaz de proteger o cabelo dos agentes externos como o vento ou a humidade, permitindo manter qualquer tipo de penteado com o brilho, volume e sedosidade desejados, graças ao seu componente de Óleo de Argão.

O seu EFEITO LONG LASTING converte-a em ideal para alisar, encaracolar, dar volume, cabelos apanhados, criar uma infinidade de penteados e manter durante todo o dia o penteado com aspeto natural e sem o compactar. A sua composição permite uma fácil eliminação com uma leve escovadela. Não deixa resíduos.

Laques Tassel Cosmetics, idéales pour chignons
Lacas da Tassel Cosmetics, ideal para updos



- » Extra forte
- » Extra forte



300 ml

REF.06270

750 ml

REF.06267



- » ECO
- » ECO

300 ml

REF.06271



LAQUE ECO TASSEL, apporte aux cheveux une excellente fixation avec une brillance naturelle tout en les protégeant des agents externes tels que le vent, l'humidité, etc. Aux mêmes caractéristiques que les laques précédentes mais sans gaz contaminants nuisibles pour l'environnement.

LACA ECO TASSEL, proporciona ao cabelo uma excelente fixação proporcionando um brilho natural ao mesmo tempo que o protege de agentes externos como o vento, humidade, etc. Com as mesmas características que as lacas anteriores, mas sem gases contaminantes nem prejudiciais para o meio ambiente.

Clips et pincés

CLIPS
E PINÇAS

*Clips, pincés à cheveux, épingles
à cheveux, élastiques*

*Clips, pinças, ganchos, diademas,
molas, pulseiras elásticas...*



Histoire de l'épingle et des antécédants História dos cliques e seus predecessores

L'origine des aiguilles pour coiffer les cheveux remonte à l'Empire Assyrien et à l'Ancienne Égypte, 25 siècles av. JC. Les restes retrouvés montrent qu'il existait des aiguilles en bois, en ivoire, en bronze et autres métaux, et que certaines étaient décorées avec des pierres précieuses, devenant ainsi des objets de luxe.

Dans la vieille Chine, le passage des jeunes filles à la vie adulte était mis en scène par une cérémonie durant laquelle elles recevaient une aiguille à cheveux.

La pince clip, comme on la connaît aujourd'hui, a été inventée par Louis Marcus, fabricant de cosmétiques à San Francisco, après la Première Guerre Mondiale. L'utilisation du clip s'est généralisée avec la mode de la coiffure dite « bob », coupe courte des cheveux à la hauteur du menton (d'où son nom en anglais « Bobby pin »).

A origem das "agulhas" para coletar cabelos remonta ao Império Assírio e ao antigo Egito, 25 séculos AC. - Os restos encontrados mostram que havia "agulhas" de madeira, marfim, bronze e outros metais. Alguns foram decorados com pedras preciosas, tornando-os itens de luxo.

Na velha China, a transição das "mulheres jovens" para a idade adulta era representada por uma cerimônia em que recebiam uma "agulha" para o cabelo. O clip de cabelo como é conhecido hoje, foi inventado por Luis Marcus, um fabricante de cosméticos em San Francisco, após a Primeira Guerra Mundial. O uso do clipe tornou-se popular quando o penteado conhecido como "bob", um corte reto até o queixo (daí o nome em inglês "Bobby pin") se tornou moda.



Objectif et forme Objetivo e forma

Le clip est un petit morceau de métal plié, utilisé pour attacher les cheveux et maintenir la coiffure en place.

O clipe é um pequeno pedaço de aço torto usado para prender o cabelo e segurar o penteado.



La bouche est la partie ouverte du clip, par laquelle doivent entrer les cheveux.

A "boca" é a parte aberta do clip, por onde o cabelo entra.

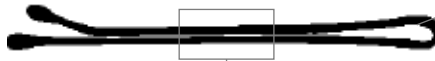

Les deux pattes du clip sont celles qui font pression pour tenir la mèche, et fixent le clip à son emplacement.

As duas "pernas" do clipe são o que seguram a trava.

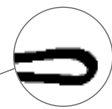

L'œil du clip a deux fonctions : Attraper la quantité maximale de cheveux possible, et faciliter la pression des pattes

O "olho" do clipe tem duas funções: suportar o máximo de cabelo possível, e facilitar a pressão das "pernas".

Processus de fabrication Processo de manufatura

Les clips que nous créons et distribuons sont fabriqués en fil d'acier, avec un contenu élevé en carbone. Cet alliage les rend plus durs, flexibles et résistants, permettant leur utilisation en de multiples occasions, sans perdre la force de pression des pattes.

Le processus de fabrication de nos clips comprend les étapes suivantes :

- 1.- Tréfilage
- 2.- Laminage
- 3.- Pliage
- 4.- Boule et peinture
- 5.- Encartage ou emboîtement

Os cliques que fabricamos e distribuimos são feitos de aço, com alto teor de carbono. Esta liga os torna mais duros, flexíveis e resistentes, permitindo que sejam usados em múltiplas ocasiões sem perder a força de pressão.

O processo de fabricação de nossos cliques:

- 1.- Desenho
- 2.- Laminado
- 3.- Dobrar o clipe
- 4.- Ponta arredondada e tinta
- 5.- Embalado

Clips DOUBLE ONDA
Clips ONDA DUPLA

- » Clips à **DOUBLE ONDA** pour cheveux courts avec une meilleure prise de cheveux pour des coiffures durables
- » Clips curtos **ONDA DUPLA** com melhor aderência de cabelo para penteados de longa duração

- » Boîte en carton contenant 24 clips
- » Pacote 24 clips



REF. 04934 REF. 04934/50

- » Boîte contenant 300 clips
- » Pacote 300 clips

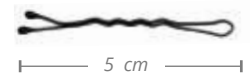

REF. 04935 REF. 04935/50

**Clips antidérapants MAT**
Clips MATE anti derrapante

- » Boîte en carton contenant 24 clips
- » Avec perle



- » Pacote 24 clips
- » Com balon

REF. 04484/50 REF. 04484/58 REF. 04484/69 REF. 04484/72

- » Boîte contenant 300 clips
- » Avec perle



- » Pacote 300 clips
- » Com bola

REF. 04522/50 REF. 04522/69



Clips ondulé MAT

Clips MATE ondulados

1 u.m.vta
288 box

1 u.m.vta
16 box

- » Boîte en carton contenant 12 clips
- » Avec perle
- » Pacote 12 clips
- » Com bola

REF. 07133 REF. 07133/50

- » Boîte contenant 200 clips.
- » Avec perle
- » Pacote 200 clips.
- » Com bola

REF. 07134 REF. 07134/50

NEW



NEW

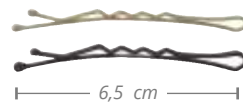

Clips ondulé

Clips ondulados

12 u.m.vta
120 box

1 u.m.vta
16 box

- » Boîte en carton contenant 24 clips
- » Avec perle

REF. 01609 REF. 01609/50

- » Pacote 24 clips
- » Com bola

- » Boîte contenant 300 clips.
- » Avec perle

REF. 01610 REF. 01610/50

- » Pacote 300 clips.
- » Com bola

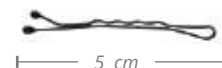

Clips ondulé

Clips ondulados

12 u.m.vta
96 box

1 u.m.vta
16 box

- » Boîte en carton contenant 24 clips
- » Avec perle
- » Pacote 24 clips
- » Com bola

REF. 01611 REF. 01611/50

- » Boîte contenant 150 clips.
- » Avec perle

REF. 01612 REF. 01612/50

- » Pacote 150 clips.
- » Com bola

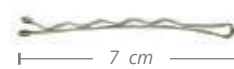
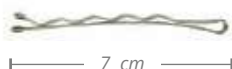

Boîte en carton contenant clips**Pacote clips**

- » 700 Mini clips.
- » Sans perle

REF. 04088 REF. 04088/50

- » 300 clips.
- » Avec perle

REF. 01604 REF. 01604/50

- » 700 Miniclips.
- » Sem bola

- » 300 clips.
- » Com bola

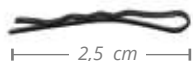

- » 200 clips.
- » Avec perle

REF. 01606 REF. 01606/50

- » 150 clips.
- » Avec perle

REF. 01608 REF. 01608/50

- » 200 clips.
- » Com bola

- » 150 clips.
- » Com bola

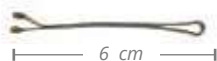
**Boîte en carton contenant pinces****Pacote ganchos**

- » 24 pincas noires
- » 24 ganchos pretos

REF. 03482

- » 24 pincas couleurs fluorescentes
- » 24 ganchos cores fluorescentes

REF. 03481



- » 12 pincas noires
- » 12 ganchos pretos

REF. 03480

- » 12 pincas couleurs fluorescentes
- » 12 ganchos cores fluorescentes

REF. 03479



Boîte contenant clips YO-YO
Pacote clips YO-YO

- » 24 clips
- » Avec perle

- » 24 clips
- » Com balon



REF. 01602

REF. 01602/50

Boîte contenant clips ONDINA
Pacote clips ONDINA

- » 12 clips
- » Avec perle

- » 12 clips
- » Com balon

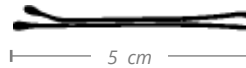

REF. 01603

REF. 01603/50

Boîte contenant clips ONDINA
Pacote clips ONDINA

- » 12 clips
- » 12 clips

REF. 01601

- » 24 mini clips
- » 24 miniclips

REF. 02879

- » 12 clip
- » 12 clips

REF. 01607



REF. 01601/50

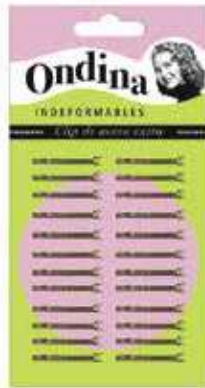

REF. 02879/50

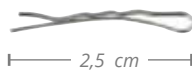

REF. 01607/50

**Boîte contenant clips EUROSTIL**
Pacote clips EUROSTIL

- » 12 clips
- » Avec perle

- » 12 clips
- » Com balon



REF. 01605

REF. 01605/50

Boîte de clips
Pacote clips1
u.m.vta 40
box» 72 douzaines de clips avec perle
» 72 dúzias clips com bola

REF. 01856 REF. 01856/50



4,8 cm

» Avec perle 200 g
» Com balon 200 gr

REF. 01863 REF. 01863/50



5 cm

» 72 douzaines de clips
» 72 dúzias clips

REF. 01855 REF. 01855/50



5,9 cm

» Avec perle. 200 g
» Com balon 200 gr

REF. 01862 REF. 01862/50



6 cm

Boîte de 200 g épingles à cheveux
Caixa 200 g. Ganchos1
u.m.vta 70
box» 600 épingles à cheveux
» 600 Ganchos

REF. 01857 REF. 01857/50



4,9 cm

» 150 épingles à cheveux
» 150 Ganchos

REF. 01858 REF. 01858/50

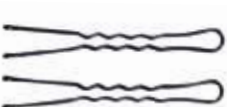

5 cm

» 340 épingles à cheveux
» 340 Ganchos

REF. 01861 REF. 01861/50



5 cm

» 150 épingles à cheveux
» 150 Ganchos

REF. 01860 REF. 01860/50

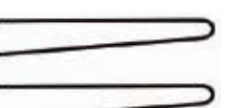

6 cm

» 160 épingles à cheveux
» 160 Ganchos

REF. 01859 REF. 01859/50



7 cm

» 95-100 épingles à
cheveux

REF. 04327 REF. 04327/50

» 95-100 Ganchos



7,5 cm

» 95-100 épingles à
cheveux

REF. 04323 REF. 04323/50

» 95-100 Ganchos



8,5 cm

1
u.m.vta 150
box

Sachets d'épingles à cheveux Bolsas ganchos

- » 20 épingles
- » à cheveux invisibles
- » 20 Ganchos invisíveis

20
u.m.vta

20
box

REF. 07131 REF. 07131/50

Boîte contenant épingles à cheveux Pacote 150 Ganchos invisíveis

- » 400 épingles
- » à cheveux invisibles
- » 400 Ganchos pequenos invisíveis

1
u.m.vta

16
box

REF. 07132 REF. 07132/50

NEW

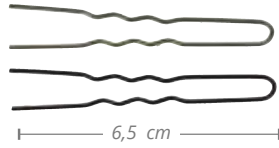

NEW

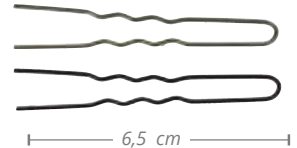

30
u.m.vta

30
box

1
u.m.vta

16
box

- » 20 épingles à cheveux invisibles et ondulés
- » 20 Ganchos de puxo invisíveis e ondulado

REF. 04089 REF. 04089/50

- » 500 petites épingles à cheveux invisibles et ondulés
- » 20 Ganchos de puxo invisíveis e ondulado

REF. 04087 REF. 04087/50

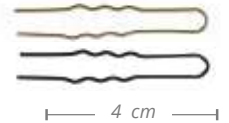
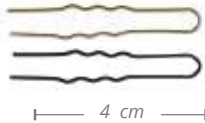

- » 20 épingles à cheveux invisibles
- » 20 Ganchos invisíveis

REF. 00030 REF. 00030/50

- » 400 épingles à cheveux invisibles
- » 400 Ganchos pequenos invisíveis

REF. 01616 REF. 01616/50

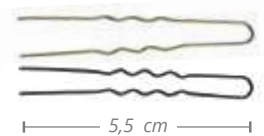
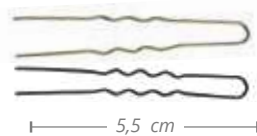

Sachets d'épingles à cheveux
Bolsas ganchos

- » 20 épingles
- » à cheveux invisibles
- » 20 Ganchos invisíveis

12 u.m.vta
20 box

REF. 00701 REF. 00701/50

**Boîte contenant épingles à cheveux**
Pacote 150 Ganchos invisíveis

- » 400 épingles
- » à cheveux invisibles
- » 400 Ganchos pequenos invisíveis

1 u.m.vta
16 box

REF. 01617 REF. 01617/50

12 u.m.vta
12 box

- » 20 épingles à cheveux invisibles
- » 20 Ganchos de puxo

REF. 04532 REF. 04532/50



- » 150 épingles à cheveux invisibles
- » 150 Ganchos de puxo

REF. 04539 REF. 04539/50

1 u.m.vta
16 box12 u.m.vta
12 box

- » 20 épingles à cheveux invisibles et ondulés
- » 20 Ganchos de invisíveis ondulado

REF. 04533 REF. 04533/50

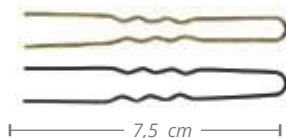

- » 150 épingles à cheveux invisibles et ondulés
- » 150 Ganchos invisíveis ondulado

REF. 04540 REF. 04540/50

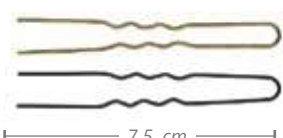
1 u.m.vta
16 box

Sachets d'épingles à cheveux Bolsas ganchos

» 10 épingles à cheveux pour réaliser un chignon de la forme courbe

» 10 Ganchos de puxo curvos



REF. 04534 REF. 04534/50



Boîte contenant épingles à cheveux Pacote 150 Ganchos invisíveis

» 150 épingles à cheveux pour réaliser un chignon de la forme courbe

» 150 Ganchos de puxo curvos



REF. 04541 REF. 04541/50



» 10 épingles à cheveux invisibles et courbes

» 10 Ganchos invisíveis curvos



REF. 04535 REF. 04535/50

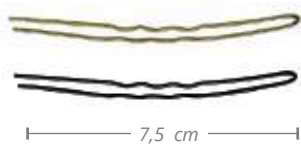

» 150 épingles à cheveux invisibles et ondulés

» 150 Ganchos invisíveis ondulado



REF. 04542 REF. 04542/50

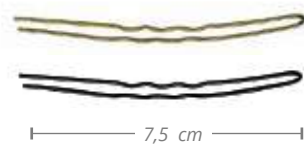

» 20 épingles à cheveux invisibles

» 20 Ganchos invisíveis



REF. 04531 REF. 04531/50

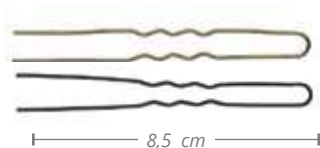

» 150 épingles à cheveux invisibles

» 150 Ganchos invisíveis



REF. 04538 REF. 04538/50

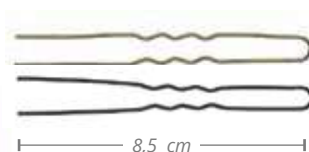

Sachets d'épingles à cheveux Bolsas ganchos

12
u.m.vta

240
box

- » 20 épingles à cheveux pour réaliser un chignon lisse
- » 20 Ganchos de puxo liso

REF. 04530 REF. 04530/50



Boîte contenant épingles à cheveux Pacote 150 Ganchos invisíveis



1
u.m.vta

16
box

- » 150 épingles à cheveux pour réaliser un chignon lisse
- » 150 Ganchos de puxo liso

REF. 04537 REF. 04537/50

12
u.m.vta

240
box

- » 6 épingles à cheveux pour réaliser un chignon de la forme courbe
- » 6 Ganchos de puxo curvos

REF. 04529 REF. 04529/50



1
u.m.vta

16
box

- » 75 épingles à cheveux pour réaliser un chignon courbe
- » 75 Ganchos de puxo curvos

REF. 04536 REF. 04536/50



Sachet épingles perle

Bolsa Ganchos pérola

12
u.m.Vta

240
box

- » 6 grandes épingles à cheveux avec ornement de perle
- » 6 Ganchos adorno pérola grande

REF. 03209 REF. 03209/50

- » 12 petites épingles à cheveux avec ornement de perle
- » 12 Ganchos adorno pérola pequena

REF. 03212 REF. 03212/50

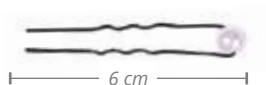

12
u.m.Vta

120
box

- » 6 grandes épingles à cheveux avec ornement de perle d'or
- » 6 Ganchos adorno pérola dourada

REF. 03210 REF. 03210/50

- » 12 épingles à cheveux avec ornement de perle d'or
- » 12 Ganchos adorno pérola dourada

REF. 03213 REF. 03213/50

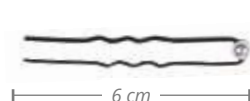
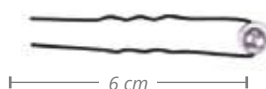

- » 6 grandes épingles à cheveux avec ornement de perle d'or
- » 6 ganchos adorno pérola dourada

REF. 03211 REF. 03211/50

- » 12 épingles à cheveux avec ornement de perle d'or
- » 12 Ganchos adorno pérola dourada

REF. 03214/50

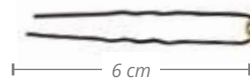
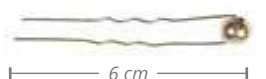

Bracelet magnétique
Pulseira de íman

Fonctionne avec plus de confort, gardez à portée de main tous les clips et épingles à cheveux grâce à notre bracelet magnétisé.

Trabalhe com mais comodidade, tenha ao seu alcance todos os clips e Ganchos graças à nossa pulseira de ímanes.



REF. 03631

» Bracelet Magnétique
» Pulseira de íman

Boîtes contenant pincas à cheveux métalliques
Pacote pinças metal

- » 120 petites pincas à cheveux
- » Tête large
- » Ref. 92

REF. 01657

- » 120 petites pincas à cheveux
- » Tête étoilée
- » Ref. 91

REF. 01656

- » 120 pinças pequenas
- » Cabeça larga
- » Ref. 92

- » 120 pinças pequenas
- » Cabeça pequena
- » Ref. 91



- » 120 pincas à cheveux
- » Double face
- » Ref. 94

REF. 01658

- » Boîte contenant 120 pincas à cheveux
- » Taille moyenne
- » Ref. 90

REF. 01655

- » 120 pinças
- » Duplas
- » Ref. 94

- » 120 pinças
- » Médias
- » Ref. 90



- » 120 pincas à cheveux
- » Taille grande
- » Ref. 95

REF. 01659

- » 120 pincas à cheveux
- » Incurvées
- » Ref. 93

REF. 01830

- » 120 pinças
- » Grandes
- » Ref. 95

- » 60 pinças
- » Curvadas
- » Ref. 93

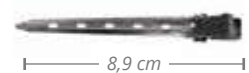

Douzaine de pincas à cheveux métalliques
Dúzia de pinças metálicas12
u.m.vta 96
boxS
REF. 00057M
REF. 00058L
REF. 00059**Pincas à cheveux métalliques en inox**
Clipes de cabelos metálicos em aço inoxidável» P-20
» P-2012
u.m.vta 96
box

S

REF. 01641

» P-30
» P-3012
u.m.vta 96
box

M

REF. 01642

» Curvada P-50
» Bend P-501
u.m.vta 100
box

L

REF. 01647

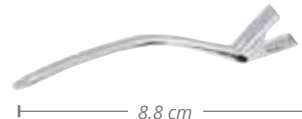
**Boîte en carton contenant pincas à cheveux**
Pacote pinças» 6 pincas à cheveux
sep. métal chromé12
u.m.vta 36
box

REF. 00804

» 6 pinças sep. metal.
cromadas» 6 pincas à cheveux
courbées12
u.m.vta 36
box

REF. 00093

» 6 pinças curvadas

» 6 pincas à cheveux
sep. couleurs métal12
u.m.vta 36
box

REF. 00803

» 6 pinças sep. metal.
cores

Carton de 10 pincas à cheveux métalliques
Pacote 10 pinças metal12
u.m.vta96
box

- » Double face
- » Dupla prata

S
REF. 00094

4,5 cm

M
REF. 00090

5,5 cm

L
REF. 00095

6,5 cm

Carton contenant pincas
Pacote pinças

- » 6 petites pincas à cheveux
- » Tête étroite

12
u.m.vta96
box

- » 10 pinças metal. peq.
- » Cabeça estreita

S
REF. 00091

4,5 cm

- » 10 petites pincas à cheveux
- » (tête large)

12
u.m.vta96
box

- » 10 pinças metal. peq.
- » Cabeça larga

S
REF. 00092

4,5 cm

- » Douze pince à cheveux
- » Courbées en aluminium

12
u.m.vta96
box

- » Dúzia pinças
- » Curvadas alumínio

REF. 00054

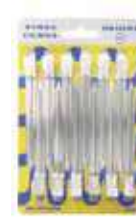

8,8 cm

- » 6 pincas à cheveux
- » incurvées
- » Couleurs et en plastique

1
u.m.vta100
box

- » 6 pinças plástico
- » Curvadas cores

REF. 00055



8,3 cm

- » 6 pincas à cheveux
- » professionnelles
- » En plastique

- » 6 pinças profissionais
- » Plástico

REF. 00075



12 cm

50
u.m.vta50
box

REF. 00075

- » 6 pincas à cheveux
- » En plastique
- » Forme de cœur

- » 6 pinças plástico
- » coração

12
u.m.vta48
box

REF. 00086



9,8 cm

Boîte de 60 petites pinces à cheveux en plastique
Caixa 60 pinças plástico pequenas



6 cm



REF. 00046

Boîte de 60 pinces à cheveux de taille moyenne en plastique
Caixa 60 pinças plástico médias



6,22 cm



REF. 00056

Boîte de 60 grandes pinces à cheveux en plastique
Caixa 60 pinças plástico grandes



6,53 cm



REF. 00066

Ensemble de jeux de moulage
Conjunto jogo para moldagem



6 cm



REF. 00687

Clip à cheveux auxiliaire
Clip auxiliar

REF. 04369

Maintient les cheveux facilement sans les abîmer sans nuire la coiffure. Un design simple et élégant en même temps. Une partie du clip fixe une mèche et l'autre munie de picots soutient l'autre mèche. C'est comme avoir un assistant du salon de coiffure à la maison.

Pour la teinture ou faire quelques mèches, suivez les instructions suivantes :

1. Faites une séparation centrale dans les cheveux et ensuite appliquez la couleur.
2. Séparez la première mèche de cheveux, la maintenir par le clip auxiliaire et ensuite appliquez la couleur sur cette mèche.
3. Séparez la mèche suivant, placez-le sur le clip et fixez-le solidement par les dents de clip.
4. Répétez l'opération jusqu'à la fin de l'application du traitement.

Sustém o cabelo facilmente sem enredá-lo e sem estragar o penteado. Com um design simples e ao mesmo tempo elegante. Uma parte do clip prende uma madeixa e outra provida de cerdas sustém outra madeixa. É como ter um assistente de salão em casa.

Para tingir ou fazer umas madeixas, siga as instruções seguintes:

1. Faça uma separação central no cabelo e depois aplique a cor.
2. Separe a primeira madeixa de cabelo, prenda-a com o clip auxiliar e depois aplique a cor sobre esta madeixa.
3. Separe a madeixa seguinte, coloque-a sobre o clip e prenda-a de forma segura com as pás.
4. Repita a operação até completar a aplicação do tratamento.



» Blister 2 pièces séparations spéciales

» Blister 2 separações especiais de peças

**Boîtes de pinces à cheveux antioxydantes**
Caixas pinças antioxidantes

- » 4 pinces à cheveux anti-glissementes
- » Avec caoutchouc



REF. 04368

- » 4 pinças antideslizant
- » Com borracha



11 cm

- » 6 pinces à cheveux anti-glissementes
- » Avec caoutchouc



REF. 04376

- » 6 pinças antideslizantes
- » Com borracha



11 cm

Boîtes 6 pinces à cheveux antioxydantes
Caixas 6 pinças antioxidantes

- » Avec des dents
- » Com dentes



REF. 03259

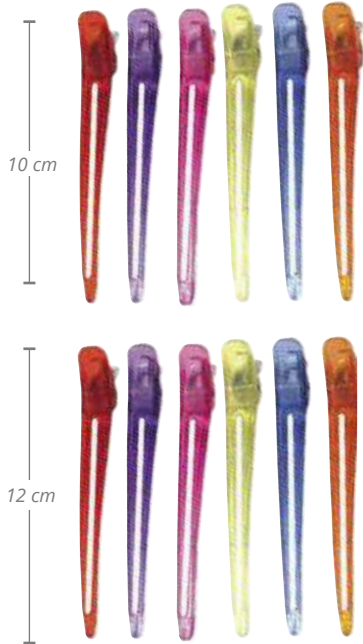

10 cm

Sachets de 6 pincas à cheveux métallique-plastique
Bolsas 6 pinças metal-plástico

S

REF. 02525/99

L

REF. 02524/99

Couleurs assorties
Cores sortidas**Sachets de 4 pincas à cheveux dragon**
Bolsas 4 pinças dragão

9 cm



REF. 04374



11 cm



REF. 03059



14 cm



REF. 04375

Sachets de 6 pincas à cheveux en plastique de couleur noire
Bolsa 6 pinças plástico pretas

- » Avec caoutchouc
- » Com borracha



REF. 02526

Boîtes de 6 pincas à cheveux anti-glissements
Caixa 6 pinças antideslizantes

- » Avec caoutchouc
- » Com borracha



12 cm



REF. 04741

Carton 4 pincas 60 mm avec caoutchouc noir
Pacote 4 pinças 60 mm com borracha preta

Pince noire avec caoutchouc pour ne pas laisser de marque sur les cheveux. Très utiles pour mettre de côté les cheveux durant les séances de maquillage puisqu'elles ne laissent pas de marque.

Pinça preta com borracha para não deixar marcas no cabelo. Muito úteis para afastar o cabelo em sessões de maquiagem já que não deixam marcas.

REF. 06388



6 cm

REF. 06389



8,2 cm

Boîte de 12 pincas à cheveux**Bolsa 12 pinças**1
u.m.vta20
boxS ●
REF. 04421S ●
REF. 04422L ●
REF. 04423L ●
REF. 04424**Sachet de 6 séparateurs pincas à cheveux de grande taille en plastique****Bolsa 6 molas separador plástico grande*** couleurs translucides
cores translúcidas12
u.m.vta48
box● ● ● ● ● ●
REF. 00081● ● ● ● ● ● ● ● ● ●
REF. 00081/76●
REF. 00081/50**Sachet de 6 pincas à cheveux de grande taille en plastique couleurs assorties****Bolsa 6 molas plástico grande diferentes cores**30
u.m.vta30
box● ● ● ● ● ●
REF. 00078●
REF. 00078/51●
REF. 00078/53**Pincas à cheveux en forme de cœur super mini****Pinças super mini coração**12
u.m.vta600
box● ● ● ● ● ●
REF. 00143●
REF. 00143/50●
REF. 00143/51**Sachet de 6 séparateurs pincas à cheveux****Bolsa 6 pinças separadoras**1
u.m.vta20
box●
REF. 04738

Pincas à cheveux en forme de cœur super grande
Pinças corações super grande

6
u.m.vta

72
box



10,8 cm

XL ●

REF. 00073/51



10,8 cm

XL ●

REF. 00073/50

Pincas à cheveux en forme de coeur de grande taille
Pinças corações super grande

6
u.m.vta

120
box



8,5 cm

L ●

REF. 00071/51



8,5 cm

L ●

REF. 00071/50

Pincas à cheveux en forme de coeur de petite taille
Pinças corações pequena

12
u.m.vta

120
box



5,9 cm

S ●

REF. 00100/50



5,9 cm

S ●

REF. 00100

» Couleurs marbrées
 » Cores marmorizadas



5,9 cm

S

REF. 00100/52

Pincas à cheveux mini en forme de cœur
Pinças corações mini diferentes cores

12
u.m.vta

600
box



3,4 cm

XS ●

REF. 00072



3,4 cm

XS ●

REF. 00072/52

Sachet de 6 pincas à cheveux d'aluminium
Bolsa 6 pinças alumínio12
u.m.vta96
box

8,9 cm

L

REF. 00070



7,6 cm

S

REF. 00080

Sachet de 6 grandes pincas à cheveux en plastique
Bolsa 12 pinças plástico grande12
u.m.vta36
box

8 cm

L

REF. 00084

Sachet de 6 pincas à cheveux en plastique de petite taille
Bolsa 6 pinças, plástico pequenas12
u.m.vta48
box

5,6 cm

S

REF. 00082



8 cm

L

REF. 00084/50



5,6 cm

S

REF. 00082/76

Sachet de 6 pincas à cheveux en plastique de grandes taille et en couleurs
Bolsa 6 pinças plástico grande cores12
u.m.vta36
box

8,2 cm

REF. 00083

Diadème polyamide couleurs assorties
Diadema poliamida cores sortidas12
u.m.vta12
box

S

REF. 01914

M

REF. 01086

L

REF. 01087



3,5 cm

20 cm



5,5 cm

10 cm



8 cm

20 cm

Boîte de 12 bandes élastique de cheveux avec crochet**Embalagem 12 pulseiras elásticas com gancho**

REF. 00640



REF. 00637

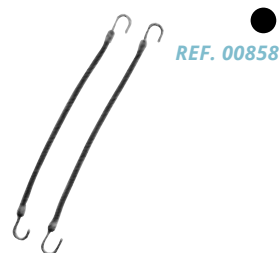

REF. 00858

Boîte de 12 bandes élastique de cheveux -queue de cheval**Embalagem 24 pulseiras elásticas rabinhol**

REF. 00634



REF. 00635

Boîte de 24 grands élastiques
Pacote 24 elásticos grandes» En polyamide
» Poliamida

REF. 00812

Boîte de 24 petits élastiques
Pacote 24 elásticos peq.» En polyamide
» Poliamida

REF. 00812/50

REF. 00812/69



REF. 00811/50

REF. 00811/69

Sachet de 12 mini élastiques
Bolsa 12 elásticos mini

REF. 03384/50



REF. 03384

Sachet de 10 bandes élastiques
Bolsa 1 elásticos anilha

REF. 03383/50



REF. 03383

Pack de 2 élastiques à cheveux spirales
Pack 2 pulseiras elásticas12
u.m.Vta12
box

REF. 04840/50



REF. 04840/69



REF. 04840/56



Ø55



REF. 04807/50



REF. 04807/69



REF. 04807/56



Ø45



REF. 04806/50



REF. 04806/69



REF. 04806/56



Ø35



Boîte de 24 élastiques tressés couleurs assorties
 Pacote 24 elásticos entrançados cores

1 u.m.vta
16 box



REF. 02261

Boîte de élastiques de couleur noir tressés
 Pacote 24 elásticos entrançados cores

1 u.m.vta
16 box



REF. 02261/50

Cartón 48 élastiques noirs
 Pacote 48 preto elástico

1 u.m.vta
24 box

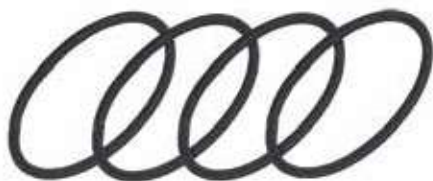

Ø5 cm

REF. 03486

Sachet 24 élastiques silicone
 Pacote elásticos de silicone

1 u.m.vta
100 box



REF. 03467/50

REF. 03467/69

REF. 03467/99

Sachet de 50 élastique en TPU pour les coiffures**Bolsa 50 elásticos de TPU**

- » Non abrasif
- » Très résistant
- » Non toxique
- » Idéal pour les tresses et les couettes

REF. 06808

REF. 06809

REF. 06810

REF. 06811

- » Não abrasivo
- » Muito resistente
- » Não tóxico

**Sachet de 2000 élastiques à cheveux****Bolsa 2000 Pulseiras elásticas**

- » 100 g environ
- » Petits

REF. 03397

- » 100g. Aprox.
- » Pequenas

**Sachet de 12 bandes élastiques anti-poux****Bolsa 12 elásticos**

- » Formulé avec de la pérégrine, un composant qui est efficace et durable pour repousser les poux et autres insectes
- » Efficacité démontrée contre les poux à 99%
- » Antiallergique et inodore
- » Tissu doux
- » Nous assurons 100 lavages sans perdre leur efficacité

REF. 04717

REF. 04718



- » Formulado com permetrina, um componente eficaz e durável para repelir piolhos e outros insetos
- » Eficácia demonstrada contra os piolhos em 99%
- » Antialérgico e sem cheiro
- » Tecido macio
- » Garantimos 100 lavagens sem perder sua eficácia

REF. 04719

REF. 04928



Sachet de 6 turbans variés**Bolsa 6 turbantes variados**

Élégance, glamour et confort se retrouvent dans notre ligne de turbans brodés sans couture. conçus et fabriqués entièrement en Espagne. Couleurs variées à montrer en toute occasion. Un complément idéal pour la femme la plus actuelle. 6 modèles disponibles.

A elegância, o glamour e a comodidade unem-se na nossa linha de turbantes bordados sem costuras. Desenhados e fabricados totalmente em Espanha. Cores variadas para brilhar em qualquer ocasião. Um complemento ideal para a mulher mais atual. 6 modelos disponíveis.

» Noir
» Preto



REF. 06055/50

» Bleu
» Azul



REF. 06055/59

» Vert
» Green



REF. 06055/62

» Beige
» Beige



REF. 06055/65

» Rose
» Rosa



REF. 06055/70

» Gris
» Cinzento



REF. 06055/72

» Grenat
» Granada



REF. 06055/73

**Sac 6 turbans colorés décorés****Saco 6 turbantes coloridos decorados**

REF. 06055/99

**Turbantes decorados**

www.eurostil.com

Pinces à perles 2 u.
Pinças com pérolas 2 un.

REF. 06937



REF. 06930



REF. 06932



REF. 06933



REF. 06934



REF. 06935



REF. 06936

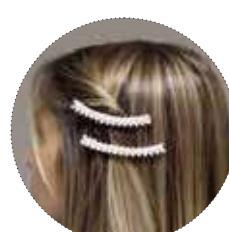

REF. 06938



Pinces à perles 2 u.
Pinças com pérolas 2 un.

REF. 06939

**Clips avec boules en verre blanc à facettes 2 u.**
Pinças com bolas de cristal branco facetado 2 un.

REF. 06931

**Clip doré à strass 2 u.**
Pinças dourado com strass 2 un.

REF. 06928



REF. 06929

**Diadème avec grosses perles 2 u.**
Diadema com pérolas grandes 2 un.

REF. 06940

**Barrette ronde avec 2 perles 2 u.**
Pinças redondo com 2 pérolas 2 un.

REF. 06941



05

Papier

PAPEL

*Serviettes, papier permanent,
protections cou ...*

*Toalhas, papel permanente, protetores
pescoço...*



Sachet 75 serviettes CELLULOSE Pacote 75 toalhas CELULOSE

- » Spéciales manucure
- » Especial manicure

50 gr/m²

REF. 04204

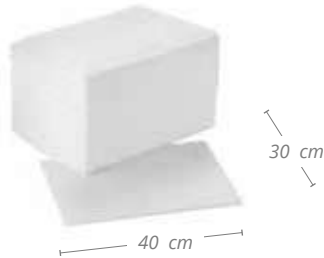

Sachet 90 Serviettes CELLULOSE Pacote 90 Toalhas CELULOSE

55 gr/m²

REF. 04076



Sachet de 25 serviettes SPUNLANCE Pacote 25 toalhas SPUNLANCE

- » Plié à 20 x 20 cm
- » 50% Polyester / 50% viscose

- » Dobrado a 20 x 20 cm
- » 50% poliéster / 50% Viscose

50 gr/m²

40 x 90 cm

REF. 04916

50 gr/m²

40 x 80 cm

REF. 03221



Sachet 100 Serviettes SPUNLANCE Pacote 100 toalhas SPUNLANCE

- » Super absorbantes
- » Superabsorventes.



REF. 03283

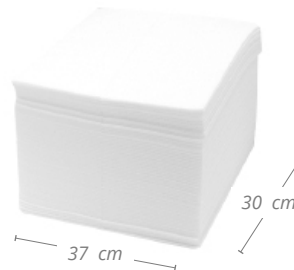

Sac sachet de 100 serviettes SPUNLANCE Bag pacote 100 toalhas SPUNLANCE

- » Composition 50% viscose / 50% Polyester
- » Très résistante et absorbante, polyvalente, pratique et jetable.
- » Entièrement sans latex, toucher extra doux
- » Super absorbantes

- » Composição: 50% viscose / 50% poliéster
- » De grande resistência e absorção, versátil, prático e descartável.
- » Totalmente livre de látex, de tato extra suave
- » Superabsorventes

50 gr/m²

REF. 07301



NEW

Sac sachet de 35 serviettes SPUNLANCE Bag pacote 35 toalhas SPUNLANCE

- » Super absorbantes
- » Serviettes pliées

- » Superabsorventes
- » Toalhas dobradas.

50 gr/m²

REF. 04509

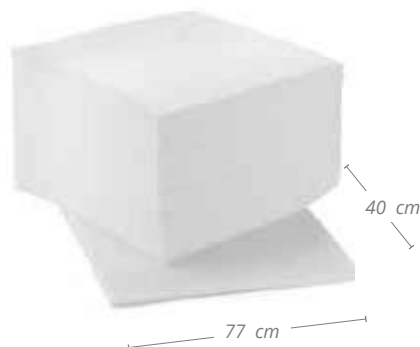

**Papier permanente super grand**
Papel permanente super grande

REF.01230

- » Boîte de 1000 feuilles.
- » Super fort Absorbant et poreux

- » Caixa 1000 folhas.
- » Super forte Absorvente e poroso

**Papier permanent**
Papel permanente

REF.01136

- » Boîte de 500 feuilles
- » de papier permanent

- » Caixa 500 folhas papel permanente

**Papier permanent super grand**
Papel permanente super grande

REF.04430

- » Boîte de 1000 feuilles.
- » Perforé permanent

- » Caixa 1000 folhas.
- » Permanente perfurada

**Papier permanent**
Papel permanente

REF.00667

- » Boîte de 1000 feuilles de papier permanent

- » Caixa 1000 folhas Permanente perfurada

**Distributeur POLLIÉ**
Dispensador POLLIÉ

REF. 00802

- » Distributeur 20 paquets x 200 feuilles papier Pointe POLLIÉ

- » Dispensador 20 livros x 200 folhas papel POLLIÉ

**Distributeur RINGLETS**
Dispensador RINGLETS

REF. 00656

- » Distributeur 20 paquets x 200 feuilles papier à permanente ringlets

- » Dispensador 20 livros x 200 folhas papel ringlets



Bracelet pour papier ringlets Pulseira para papel ringlets



REF.00657/50



REF.00657

Papier cou 100 services Rolo Papel pescoço 100 utilizações



- » Colle bleue d'usage facile
- » Qualité premium
- » S'ajuste parfaitement et rapidement
- » Hygiénique, 1 seul usage.
- » Papier jetable
- » Élastique. S'ajuste à tous les cous.
- » Conçu pour être utilisé dans les salons de coiffure et de barbier
- » Prévient les picotements et démangeaisons au cou

- » Cola azul para fácil colagem e posicionamento
- » Qualidade premium
- » Ajuste perfeito e rápido
- » Descartável
- » Elástico, ajustável em cada pescoço
- » Projetado para cabeleireiros e barbeiros profissionais
- » Não irritant



REF. 00681

Supports pour papier Porta rolos

- » Pour le papier cou 00681, 04651, 06596, 06927
- » Para papel pescoço roll 00681, 04651, 06596, 06927



REF. 00800

- » Matière : abs noir
- » Peut être accroché au mur.
- » Material: ABS preto
- » Pode-se pendurar na parede e espelho



REF. 06803



06

Formation

TREINAMIENTO

*Têtes malléables, trépieds,
supports pour table ...*

*Cabeças manequim, tripés,
suportes para mesa...*



Têtes malléables 100% CHEVEUX NATURELS
Cabeças manequim CABELO 100% NATURAL

 Support inclus
 Suporte incluído

- » 42 implantations cm²
- » 6-7 implants capillaires
- » 260 cheveux env. au cm²
- » Pour couper, décolorer, colorer, permanente, coiffures, chignons, séchage et lissage des cheveux
- » Température maximum 180°C
- » Implantation classique 90°

- » 42 Implantes por cm²
- » 6-7 cabelos por implante
- » 260 cabelo por cm²
- » Para corte, descoloração, coloração, permanente, penteado, coletado, seco e com prancha
- » Temperatura máxima 180°C
- » Implantação clássico 90°

Châtain · Castanho

REF. 01455



REF. 00624



REF. 00603



REF. 01142

Blond très clair · Loiro muito claro

- » Ne pas décolorer
- » Não descolorir



REF. 04251

- » Avec cils
- » Ne pas décolorer
- » Com pestanas
- » Não descolorir



REF. 04586

Têtes malléables 100% CHEVEUX NATURELS
Cabeças manequim CABELO 100% NATURAL

 Support non inclus
 Suporte não incluído

- » 42 implantations cm2
- » 7-8 implants capillaires
- » 320 cheveux env. au cm2
- » Pour couper, décolorer, colorer, coiffures, séchage et lissage des cheveux
- » Température maximum 180°C

- » 42 implantes por cm2
- » 7-8 cabelos por implante
- » 320 cabelo por cm2
- » Para corte, descoloração, coloração, penteado, seco e com prancha
- » Temperatura máxima 180°C

Châtain clair · Castanho claro

» Implantation classique

» Implantação clássica



35 - 40 cm

Ø 50

Leia

REF. 06642

» Implantation naturelle

» Implantação natural



35 - 40 cm

Ø 50

Amber

REF. 06643

» Implantation naturelle

» Implantação natural



45 - 50 cm

Ø 50

Jenny

REF. 06644

» Implantation naturelle

» Implantação natural



55 - 60 cm

Ø 50

Daisy

REF. 06645

» Implantation naturelle 45°

» Implantação natural 45°



20 - 30 cm

Ø 54

Lucy

REF. 06149

» Implantation classique 90°

» Implantação clássica 90°



20 - 30 cm

Ø 54

Lucy

REF. 04910

Têtes malléables 100% CHEVEUX NATURELS
Cabeças manequim CABELO 100% NATURAL

Support non inclus
 Suporte não incluído



- » Implantation naturelle 45°
- » Avec cils
- » 42 implantations cm2
- » 6-7 implants capillaires
- » 260 cheveux env. au cm2
- » Pour couper, décolorer, colorer, permanente, coiffures, chignons, séchage et lissage des cheveux
- » Température maximum 180°C

- » Implantação natural 45°
- » Com pestanas.
- » 42 implantes por cm2
- » 6-7 cabelos por implante
- » 260 cabelo por cm2
- » Para corte, descoloração, coloração, permanente, penteado, coletado, seco e com prancha
- » Temperatura máxima 180°C



Châtain foncé · Castanho escuro

Emily

REF. 04905



35 - 40 cm

Ø 54



45 - 50 cm

Ø 54

Lisa

REF. 04906



55 - 60 cm

Ø 54

Rose

REF. 04907

Têtes malléables 100% CHEVEUX NATURELS
Cabeças manequim CABELO 100% NATURAL

 Support non inclus
 Suporte não incluído

- » Avec des cils
- » Implantation naturelle 45°
- » 42 implantations cm2
- » 6-7 implants capillaires
- » 260 cheveux env. au cm2
- » Pour couper, décolorer, colorer, permanente, coiffures, chignons, séchage et lissage des cheveux
- » Température maximum 180°C

- » Com pestanas
- » Implantação natural 45°
- » 42 Implantes por cm2
- » 6-7 cabelos por implante
- » 260 cabelo por cm2
- » Para corte, descoloração, coloração, permanente, penteado, coletado, seco e com prancha
- » Temperatura máxima 180°C

Noir · Preto

» Cheveux Remy

» Cabelo Remy



40 - 45 cm

Ø 54

Chloe
REF. 04904

Blond très léger · Loira muito leve

 » Ne pas se décolorer
 » Implantation naturelle 45°

 » Não descolorir
 » Implantação natural 45°

45 - 50 cm

Ø 54

Sophie
REF. 04903

Têtes malléables homme 100% CHEVEUX NATURELS Cabeças manequins homem CABELO 100% NATURAL

Support inclus
Suporte incluído



- » 42 implantations cm2
- » 7-8 implants capillaires
- » 320 cheveux env. au cm2
- » Pour couper, décolorer, colorer,
- » coiffures, séchage et lissage des cheveux
- » Température maximum 180°C

- » 42 Implantes por cm2
- » 7-8 cabelos por implante
- » 320 cabelo por cm2
- » Para corte, descoloração, coloração, penteado, seco e com prancha
- » Temperatura máxima 180°C

Châtain · Castanha

- » Implantation naturelle 45°

» Implantação natural 45°



15 - 18 cm

Ø 58

REF. 02495

Châtain avec barbe · Castanha com barba

- » Implantation naturelle 45°
- » Idéale pour exercice de coupe et de taille de barbe

» Implantação natural 45°
» Também para corte de barba



15 - 18 cm

Ø 58

REF. 02169

Support non inclus
Suporte não incluído

Châtain clair Joe · Castanho claro

- » Implantation naturelle 45°

» Implantação natural 45°



15 - 18 cm

Ø 54

REF. 06147

- » Implantation classique 90°

» Implantação clássico 90°



15 - 18 cm

Ø 54

REF. 04909

Châtain clair avec barbe Daniel · Castanho claro com barba

- » Implantation naturelle 45°

» Implantação natural 45°



15 - 18 cm

Ø 54

REF. 06148

- » Implantation classique 90°

» Implantação clássico 90°



15 - 18 cm

Ø 54

REF. 04908

Têtes malléables, CHEVEUX 100% SYNTHÉTIQUES
Cabeças manequim, CABELO 100% SINTÉTICO

Support non inclus
 Suporte não incluído



- » Implantation naturelle 45°
- » 42 implantations au cm²
- » 5-6 implants capillaires
- » 210 cheveux env. au cm²
- » Pour couper, coiffures, chignons, séchage et lissage des cheveux
- » Température maximum 180°C
- » Ne pas permanentiser, décolorer ni teindre

- » Implantação natural 45°
- » 42 Implantes por cm²
- » 5-6 cabelos por implante
- » 210 cabelo por cm²
- » Para corte, penteado, coletado, seco e com prancha.
- » Temperatura máxima 180°C
- » Não descolorir, permanente e não tingir

Blonde · Loiro



REF. 04954

35 - 40 cm

Ø 54



REF. 04955

45 - 50 cm

Ø 54



REF. 04956

55 - 60 cm

Ø 54

Têtes malléables, CHEVEUX SYNTHÉTIQUES 100% PRO-H
Cabeças manequim, CABELO SINTÉTICO 100% PRO-H

Support inclus
 Suporte incluído



- » Pour couper, coiffures, chignons, séchage et lissage
- » Température maximum 140°C
- » Ne pas décolorer
- » 42 implantations cm2
- » 6-7 implants capillaires
- » 260 cheveux env. au cm2
- » Implantation classique 90°C
- » Suitable for dyeing and permanent

- » Para corte, penteado, coletado, seco e com prancha
- » Temperatura máxima 140°C
- » Não descolorir
- » 42 Implantes por cm2
- » 6-7 cabelos por implante
- » 260 cabelo por cm2
- » Implantação clássica 90°C
- » Adequado para tingimento e permanente

Blond clair · Loiro claro



Ø 50

10 - 40 cm

REF. 02543



Ø 50

55 - 60 cm

REF. 02545



COLORATION PERMANENTE
 TINTA E PERMANENTE



MAX 140°



Ø 50

45 - 50 cm

REF. 02544

BERGMANN

HAIR AND MORE...

Têtes malléables 100% CHEVEUX NATURELS
Cabeças manequim CABELO 100% NATURAL

Support non inclus
 Suporte não incluído



Blonde · Loiro

» Implantation naturelle
 » Couper, coiffures, permanente, colorer

» *Implantação natural.*
 » *Para corte, coloração, penteado, permanente*

Blonde · Loiro

» Implantation naturelle
 » Couper, colorer

» *Implantação natural*
 » *Para corte, coloração*



Ø 53

30 - 35 cm
 aprox.

Junior
 REF. 06342



30 - 35 cm
 aprox.

Teeny
 REF. 06344

Châtain · Castanho

» Implantation naturelle
 » Couper, colorer

» *Implantação natural*
 » *Para corte, coloração*

Teeny

REF. 06345

Boy

REF. 06341



30 - 35 cm
 aprox.



20 cm
 aprox.

Ø 56

Supports tête malléable Suportes cabeça manequim

» Plastique
» Plástico



1 u.m.vta
25 box

REF. 00983

» Plastique
» Plástico



1 u.m.vta
25 box

REF. 01461

» Plastique
» Plástico



1 u.m.vta
10 box

REF. 06276

» Plastique
» Plástico



1 u.m.vta
10 box

REF. 06162

» Aluminium
» Alumínio



1 u.m.vta
12 box

REF. 03625

Support trépied de tête malléable Suporte tripé cabeça manequim

» Aluminium
» Alumínio

1 u.m.vta
10 box

REF. 03738

» Aluminium
» Alumínio



1 u.m.vta
6 box

REF. 03624

» Aluminium
» Alumínio

1 u.m.vta
6 box

REF. 01841



166 - 81 cm

133 - 65 cm

126 - 78 cm

Mobilier

MOBILIÁRIO

*Coiffeuses, fauteuils, bacs de lavage,
étagères, chariot...*

*Desk, assentos, rampa de lavagem,
prateleiras, carrinhos...*



Comptoir de réception en bois et métal à effet miroir
Mesa -recepção de madeira e metal efeito espelho



REF.03935

Avec compartiments intérieurs en bois pour le stockage et l'étagère
 Com compartimentos de madeira interiores e prateleira



Meuble coiffure de réception en bois de chêne earth
Mesa -recepção carvalho earth



- » Laminé en graphite
- » Avec étagères réglables et 1 tiroir

- » Laminado em grafite
- » Com prateleiras ajustáveis e 1 gaveta

REF.04518/50

REF.04518/65



REF.04518/58

REF.04518/72

Double coiffeuse Espelho duplo

- » Avec armoire, table et repose-pieds
- » Com armário, mesa e repousa-pés



REF.03949



Canapé d'attente 3 places Sofá de espera 3 lugares

- » En skai
- » Em pele ecológica



REF.03950



Coiffeuse murale mercury Espelho mercury carvalho



Graphite · Grafite ●
REF.04517/50

Blanc · Branco ○
REF.04517/58

Chêne · Mural ●
REF.04517/65

Grise · Cinza ●
REF.04517/72



- » Laminé en graphite
- » Avec tablette avec support pour sèche-linge et repose-pieds chromé intégré

- » Laminado em grafite
- » Com prateleira com suporte para secador e apoio para os pés cromado

Coiffeuse rectangulaire Espelho retangular



REF.06099



- » Coiffeuse RECTANGULAIRE unisexe élégante et sophistiquée avec grand coiffeuse. Comprend une étagère pour soutenir les objets que vous voulez. En plus d'un repose-pieds confortable.

- » Espelho RETANGULAR unissexo elegante e sofisticado com grande superfície de espelho. Inclui uma estante para apoiar os objetos que desejar. Além de um cómodo repousa-pés.

Fauteuils coiffage enfants Assentos para crianças



Fauteuils pour enfants, de haute qualité, en métal et style vintage pour que l'expérience d'aller au salon de coiffure soit agréable et sans drames. karts à pédales pour les enfants qui fonctionnent sont démontés du support. Lumières décoratives et ceinture de sécurité. De plus, si le volant est tourné, les roues avant bougent. Ne contient pas de klaxon.

Assentos para crianças, de grande qualidade, feitas em metal e com estilo vintage para que a experiência de ir ao cabeleireiro seja agradável e livre de dramas. Carros com pedais que funcionam desmontados do suporte e luzes decorativas. Ao girar o volante movem-se as rodas dianteiras.



24 kg

REF.04728



26,8 kg

REF.04727



Fauteuil spécial pour enfants Cadeira especial para crianças



REF.02733



54-79 cm

Coussins spéciaux pour enfants Almofadas especiais para crianças



Nous avons également des coussins spéciaux adaptés à toutes les Fauteuils de coiffure qui permettent un travail plus confortable au professionnel car ils élèvent l'enfant à la bonne hauteur..

Também temos almofadas especiais aptos para qualquer salão de cabeleireiro que permitem um trabalho mais cómodo ao profissional, elevam a criança à altura idónea.



REF.04506/50



REF.04506/58



REF.04506/59



REF.04506/60

Coussins spéciaux pour enfants Almofadas especiais para crianças



REF.07329/50



NEW

Coussins spéciaux pour enfants Almofadas especiais para crianças



REF.03939



REF.04506/69

Tabouret STREET
Tamborete STREET

Le tabouret STREET classique contient une pompe hydraulique qui vous permettra de l'ajuster à la hauteur souhaitée, facilitant ainsi votre travail.

Tamborete STREET clássico com bomba hidráulica para regular a altura conforme desejado em cada trabalho.



REF.06103/50



REF.06103/58

**Comparatif 04419 - 06103**
Comparativo 04419 - 06103**Tabouret base en métal**
Tamborete base metal

REF.04419/50



REF.04419/58

**Tabouret SWEET SIT**
Tamborete SWEET SIT

REF.01328

Tabouret RODEO
Tamborete RODEIO

REF.01964

Tabouret URBAN
Tamborete URBAN

Tabouret ergonomique URBAN avec pompe hydraulique pour ajuster la hauteur. Sa forme s'adapte au corps et par conséquent favorise une meilleure posture et évite le mal de dos après plusieurs heures de travail.

Banco URBAN ergonómico com bomba hidráulica para regular a altura conforme desejado em cada trabalho. A sua forma adapta-se ao corpo e como consequência propicia uma melhor postura e evita as dores de costas depois de muitas horas de trabalho.



REF.06102/50



REF.06102/58

Comparatif 04382 - 06102
Comparativo 04382- 06102**Tabouret avec base en métal**
Tamborete base metal

REF.04382/50



REF.04382/58

Repose-pieds
Repousa-pés

REF.04384

REF.04385

REF.02838

Repose-pieds droit en métal
Repousa-pés reto metalRepose-pieds incurvé en métal
Repousa-pés curvado metal

Tabouret avec support et système de régulation
Tamborete com encosto e regulação

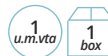

REF.02730/50

REF.02730/58

REF.02730/54

Tabouret avec support et système de régulation
Tamborete com encosto e regulação



REF.02732

REF.02732/58

Tabouret avec support et système de régulation
Tamborete com encosto e regulação



REF.03937/50

REF.03937/58

Tabouret FASHION
Tamborete FASHION



Tabouret FASHION avec dossier pour plus de confort et de soutien au dos. Roues anti-pois. Entretien facile

Banco FASHION com encosto para mais comodidade e apoio de costas. As rodas estão concebidas para evitar que o cabelo fique preso nelas. São fáceis de limpar



REF.06101/58

Bac de lavage GLAMOUR Rampa de lavagem GLAMOUR



Nouvelle Fauteuil de coiffure GLAMOUR. Design aux lignes droites et modernes mais avec un confort maximal. Réglable en hauteur grâce à sa pompe hydraulique.

REF.07191

Nova cadeira de cabeleireiro GLAMOUR. Design de linhas retas e modernas, mas com a máxima comodidade. Ajustável em altura graças à sua bomba hidráulica.

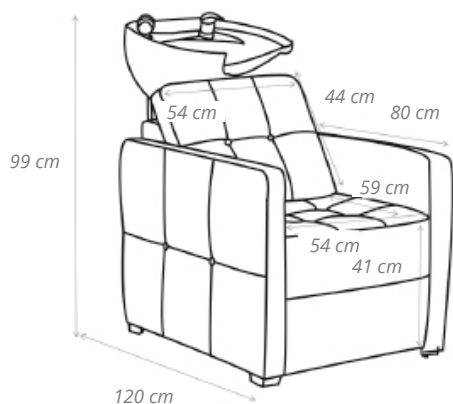

NEW

Bac de lavage KURVA Rampa de lavagem KURVA



Nouvelle Fauteuil de coiffure KURVA. Design aux lignes droites et modernes mais avec un confort maximal. Pourvu d'une cuvette en céramique ergonomique et basculante.

REF.07193

Nova cadeira de cabeleireiro KURVA. Design de linhas retas e modernas, mas com a máxima comodidade. Provida de uma bacia de cerâmica ergonómica e reclinável.

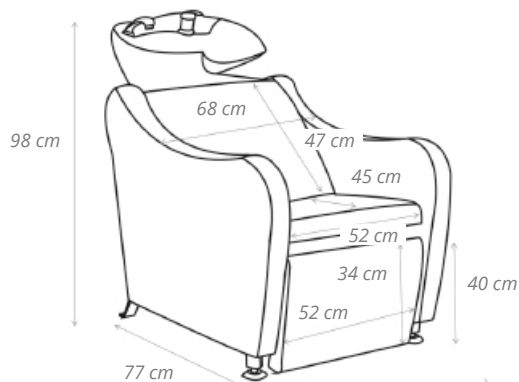

NEW

Bac de lavage OVAL

Rampa de lavagem OVAL

1 u.m.vta 1 box

REF.07195

Nouvelle Fauteuil de coiffure OVAL. Design aux lignes droites et modernes mais avec un confort maximal. Pourvu d'une cuvette en céramique ergonomique et basculante.

Nova cadeira de cabeleireiro OVAL. Design de linhas retas e modernas, mas com a máxima comodidade. Provida de uma bacia de cerâmica ergonómica e reclinável.

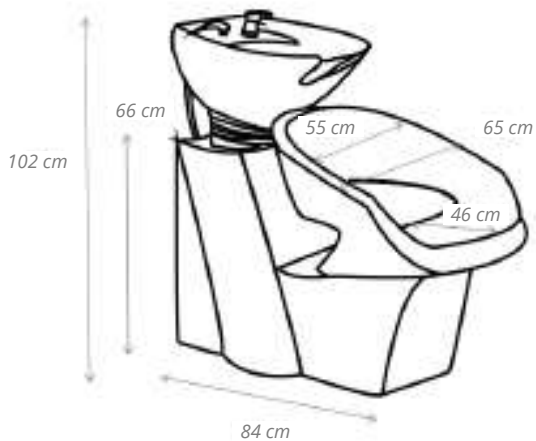

NEW

Bac de lavage KVADRAT

Rampa de lavagem KVADRAT

1 u.m.vta 1 box

REF.07197

Nouvelle Fauteuil de coiffure KVADRAT. Design aux lignes droites et modernes mais avec un confort maximal. Réglable en hauteur grâce à sa pompe hydraulique.

Nova cadeira de cabeleireiro KVADRAT. Design de linhas retas e modernas, mas com a máxima comodidade. Ajustável em altura graças à sua bomba hidráulica.

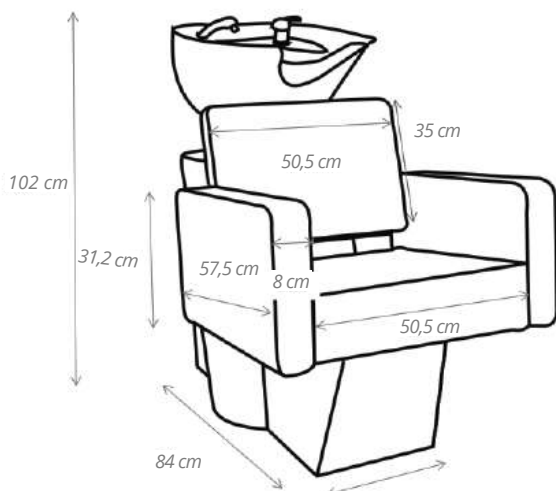

NEW

Bac de lavage PIN UP Rampa de lavagem PIN UP



En raison de la mousse de rembourrage, les mesures peuvent avoir une petite variation d'environ 1 cm

REF.06476/70

As medições podem variar ligeiramente devido à espuma do revestimento, 1 cm por superfície.



Bac de lavage STIL Rampa de lavagem STIL



- » Repose-bras et télécommande chromés.
- » Vasque en céramique et base fibre de verre.
- » Assise coulissante.
- » Longueur base: 76 cm
- » Largeur siège: 48 cm
- » Hauteur dossier: 41 cm
- » Céramique: 57x50x20cm
- » Hauteur totale: 95 cm

- » Apoia-braços e comando cromados.
- » Telha de cerâmica e base fibra de vidro.
- » Assento deslizável.
- » Largura base 76 cm
- » Largura assento 48 cm
- » Altura encosto 41 cm
- » Cerâmica 57x50x20cm
- » Altura total 95 cm



REF. 02841



REF. 02841/54



REF. 02841/58

Bac de lavage NEPTUNE

Rampa de lavagem NEPTUNO

1 u.m.vta 1 box

- » Structure en acier et bois
- » Céramique blanche inclinable
- » Siège fixe
- » Mitigeur douche noir

- » Estrutura em aço e madeira
- » Cerâmica branca basculante
- » Assento fixo
- » Mono comando duche preto



		
REF.04516/50	REF.04516/58	REF.04516/60
		
REF.04516/62	REF.04516/64	REF.04516/65
		
REF.04516/68	REF.04516/69	REF.04516/72

Bac de lavage VENUS





Rampa de lavagem VENUS

1 u.m.vta 1 box

- » Structure en polyéthylène
- » Céramique blanche inclinable
- » Siège fixe
- » Mitigeur douche noir

- » Estrutura de polietileno
- » Cerâmica branca basculante
- » Assento fixo
- » Mono comando duche preto



		
REF.04514/50	REF.04514/58	REF.04514/60
		
REF.04514/62	REF.04514/64	REF.04514/65
		
REF.04514/68	REF.04514/69	REF.04514/72

Séparateur bac de lavage VENUS NOIR

Separador rampa de lavagem VENUS PRETO

1 u.m.vta 1 box



REF.04515

Bac lavage ART

Rampa de lavagem ART

1
u.m.vta

1
box

Le nouveau lave-tête ART a un design avec des lignes courbes, en noir et fini en argent, mais en même temps est conçu pour donner un maximum de confort au client tout en se lavant les cheveux. Il est composé d'une vasque en céramique, profond, ergonomique, inclinable et adaptable à chaque service. Conjointement avec la Fauteuil ART font l'ensemble idéal pour votre salon.

A novo rampa de lavagem ART tem um design com linhas curvas, de cor preta e com acabamentos em prata, mas que ao mesmo tempo são pensadas para conferir a máxima comodidade ao cliente enquanto lava o cabelo. É composto por uma pia de cerâmica funda, ergonômica, reclinável e adaptável em cada serviço. Juntamente com o assento ART formam o conjunto ideal para o seu salão.

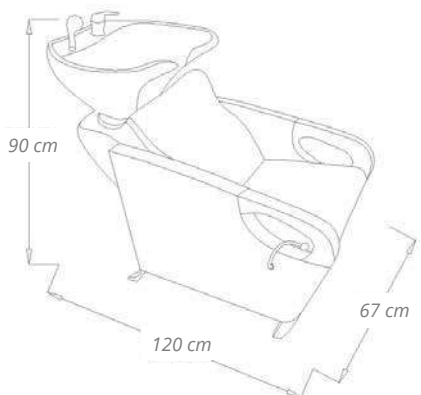

REF.06097/50

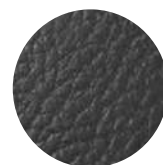

Inclinable
Reclinado



Bac lavage MOOD
Rampa de lavagem MOOD1
u.m.vta1
box

Le nouveau lave-tête MOOD a un design avec des lignes courbes, en noir et fini en argent, mais en même temps est conçu pour donner un maximum de confort au client tout en se lavant les cheveux. Il est composé d'un brochet en céramique, profond, ergonomique, inclinable et adaptable à chaque service. Conjointement avec la Fauteuil MOOD font l'ensemble idéal pour votre salon.

A novo rampa de lavagem MOOD tem um design com linhas curvas, de cor preta e com acabamentos em prata, mas que ao mesmo tempo são pensadas para conferir a máxima comodidade ao cliente enquanto lava o cabelo. É composto por uma pia de cerâmica funda, ergonômica, reclinável e adaptável em cada serviço. Juntamente com o assento MOOD formam o conjunto ideal para o seu salão.

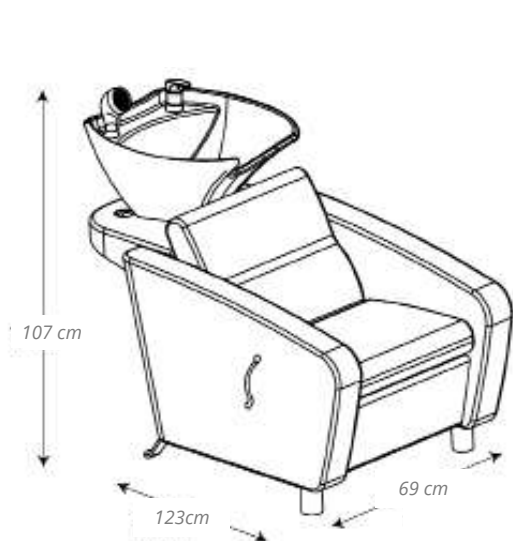

REF.06098/50

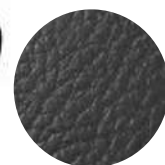
Inclinable
Reclinado

Fauteuil de coiffure GLAMOUR
Mesa de cabeleireiro GLAMOUR1
u.m.vta1
box

REF.07190

Nouvelle Fauteuil de coiffure GLAMOUR. Design aux lignes droites et modernes mais avec un confort maximal. Réglable en hauteur grâce à sa pompe hydraulique.

Nova cadeira de cabeleireiro GLAMOUR. Design de linhas retas e modernas, mas com a máxima comodidade. Ajustável em altura graças à sua bomba hidráulica.

NEW

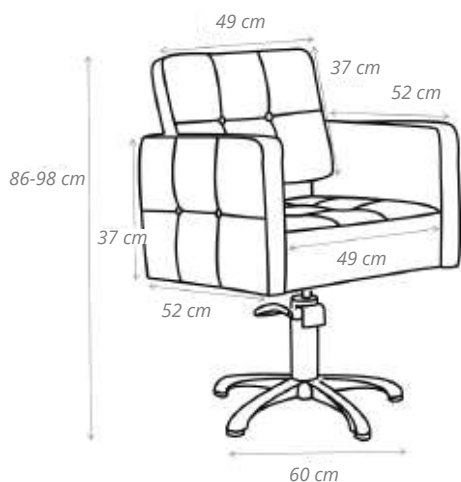
**Fauteuil de coiffure KURVA**
Mesa de cabeleireiro KURVA1
u.m.vta1
box

REF.07192

Nouvelle Fauteuil de coiffure KURVA. Design aux lignes droites et modernes mais avec un confort maximal. Réglable en hauteur grâce à sa pompe hydraulique.

Nova cadeira de cabeleireiro KURVA. Design de linhas retas e modernas, mas com a máxima comodidade. Ajustável em altura graças à sua bomba hidráulica.

NEW

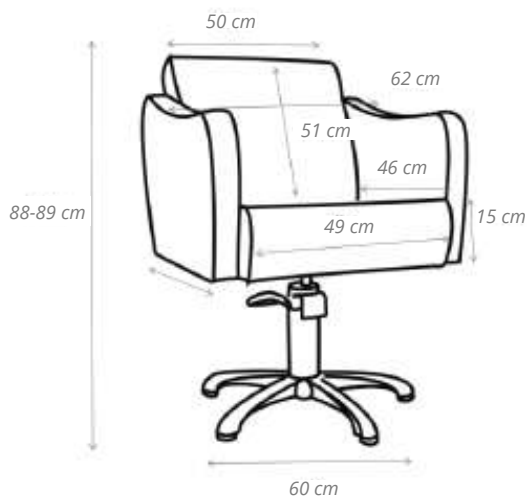

Fauteuil de coiffure OVAL Mesa de cabeleireiro OVAL

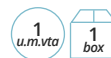

REF.07194

Nouvelle Fauteuil de coiffure OVAL. Design aux lignes droites et modernes mais avec un confort maximal. Réglable en hauteur grâce à sa pompe hydraulique.

Nova cadeira de cabeleireiro OVAL. Design de linhas retas e modernas, mas com a máxima comodidade. Ajustável em altura graças à sua bomba hidráulica.

NEW

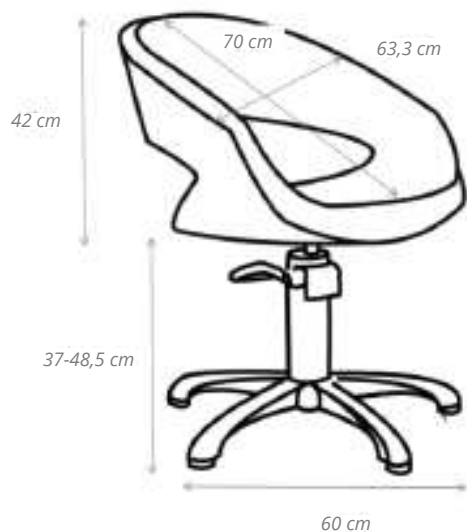

Fauteuil de coiffure KVADRAT Mesa de cabeleireiro KVADRAT



REF.07196

Nouvelle Fauteuil de coiffure KVADRAT. Design aux lignes droites et modernes mais avec un confort maximal. Réglable en hauteur grâce à sa pompe hydraulique.

Nova cadeira de cabeleireiro KVADRAT. Design de linhas retas e modernas, mas com a máxima comodidade. Ajustável em altura graças à sua bomba hidráulica.

NEW

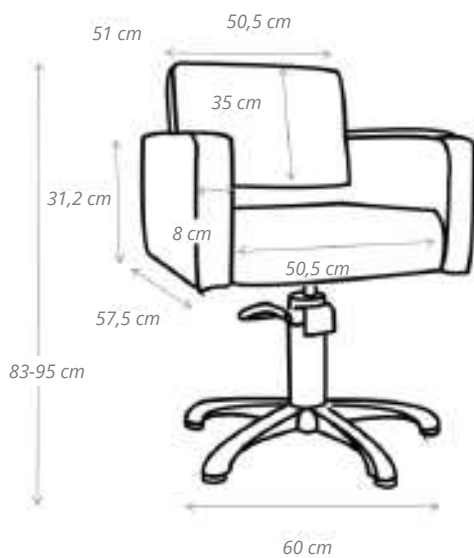

Fauteuil de coiffure COMFORT Mesa de cabeleireiro COMFORT

1 u.m.vta
1 box



La Fauteuil de coiffure COMFORT a un design avec des lignes droites, mais en même temps elle est conçue pour donner un maximum de confort. La Fauteuil dispose d'une pompe hydraulique qui vous permet de soulever et d'abaisser le siège, de sorte que vous pouvez placer le client à la hauteur qui convient le mieux à chaque travail.

O mesa de cabeleireiro COMFORT tem um design com linhas retas, mas que ao mesmo tempo estão pensadas para dar a máxima comodidade. O assento tem uma bomba hidráulica, a qual permite subir e baixar o assento, desta forma poderá situar o cliente à altura que se adapte melhor a cada trabalho.

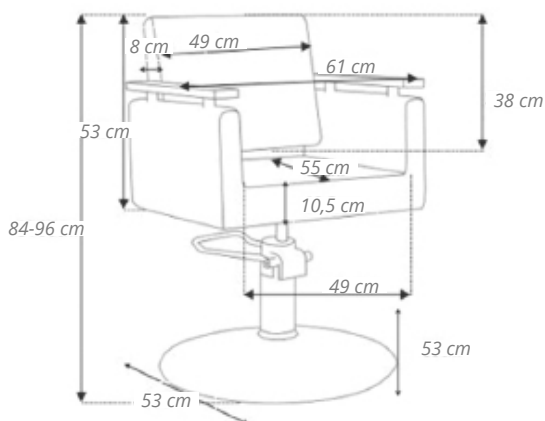

REF.06585

Pied étoile
Pé estrela

Fauteuil de coiffure PIN UP Mesa de cabeleireiro PIN UP

1 u.m.vta
1 box

La Fauteuil de coiffure PIN UP a un design avec des lignes droites, mais en même temps elle est conçue pour donner un maximum de confort. La Fauteuil dispose d'une pompe hydraulique qui vous permet de soulever et d'abaisser le siège, de sorte que vous pouvez placer le client à la hauteur qui convient le mieux à chaque travail.

O mesa de cabeleireiro PIN UP tem um design com linhas retas, mas que ao mesmo tempo estão pensadas para dar a máxima comodidade. O assento tem uma bomba hidráulica, a qual permite subir e baixar o assento, desta forma poderá situar o cliente à altura que se adapte melhor a cada trabalho.

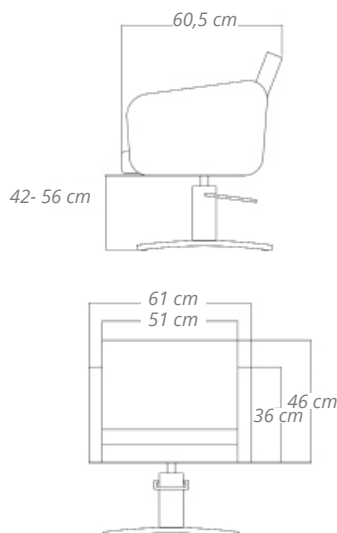

REF.06477/70

Fauteuil STRATOS

Cadeira STRATOS

- » Avec repose-pieds
- » Système d'élévation hydraulique.
- » Dossier 52 x 45 cm
- » Largeur bras bras 50 cm
- » Base du siège 48 cm
- » Bras chromés

- » Com repouso-pés
- » Elevação hidráulica.
- » Encosto 52 x 45 cm
- » Largura braço a braço 50 cm
- » Base assento 48 cm
- » Braços cromados

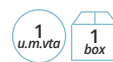

REF. 02840

REF.02840/54

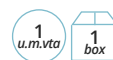
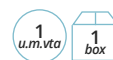

REF.02840/60

REF.02840/59

Fauteuil hydraulique VENUS noir

Mesa hidráulico VENUS preto

- » Base étoilée en aluminium
- » Élévation hydraulique
- » Revêtement noir
- » Largeur : 58 cm
- » Profondeur : 64 cm
- » Hauteur élévation fauteuil : 45 cm – 60,5 cm

- » Base estrela de alumínio
- » Levantamento hidráulico
- » Estofado em preto
- » Largura: 58 cm
- » Profundidade: 64 cm
- » Altura de elevação do assento: 45 cm - 60,5 cm

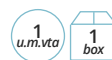

REF.04513/50

REF.04513/58

REF.04513/60

REF.04513/62

REF.04513/64

REF.04513/65



REF. 04513/68

REF.04513/69

REF.04513/72

Fauteuil de coiffure CHIC
Mesa de cabeleireiro CHIC

La Fauteuil de coiffure CHIC a un design classique qui combine des lignes droites et des courbes. Conçue pour donner un maximum de confort. La Fauteuil dispose d'une pompe hydraulique qui vous permet de soulever et d'abaisser le siège, de sorte que vous pouvez placer le client à la hauteur qui convient le mieux à chaque travail. Combinable avec 3 pieds. Option repose-pieds disponible.

O mesa de cabeleireiro CHIC tem um design clássico que combina linhas retas e curvas, pensadas para dar a máxima comodidade. O mesa tem uma bomba hidráulica que permite subir e baixar o assento, desta forma poderá situar o cliente à altura que se adapte melhor a cada trabalho. Combinável com 3 pés, e com a opção de repouso-pés.

REF.06096/50/2 REF.06096/50/5*

REF.06096/50/3 REF.06096/50/6*

REF.06096/50/1 REF.06096/50/4*

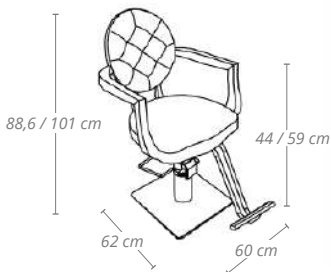

*Avec repose-pieds
*Com apoio para os pés

Fauteuil de Coiffure STYLE
Mesa de cabeleireiro STYLE

La Fauteuil de Coiffure STYLE a un design vintage qui combine des lignes courbes, en noir et avec des coutures blanches, conçue pour donner un maximum de confort. La Fauteuil dispose d'une pompe hydraulique qui vous permet de soulever et d'abaisser le siège, de sorte que vous pouvez placer le client à la hauteur qui convient le mieux à chaque travail. Combinable avec 3 pieds. Option repose-pieds disponible.

A mesa de cabeleireiro STYLE tem um design vintage que combina linhas curvas, em preto e com acabamentos brancos, concebidos para proporcionar o máximo conforto. O mesa tem uma bomba hidráulica que permite subir e baixar o assento, desta forma poderá situar o cliente à altura que se adapte melhor a cada trabalho. Combinável com 3 pés, e com a opção de repouso-pés.

REF.06095/50/2 REF.06095/50/5*

REF.06095/50/3 REF.06095/50/6*

REF.06095/50/1 REF.06095/50/4*

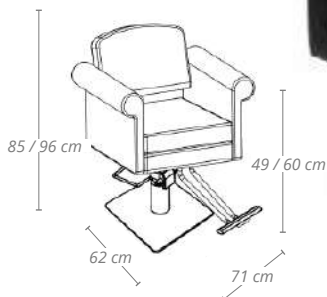

*Avec repose-pieds
*Com apoio para os pés

Fauteuil de coiffure BOHEMIAN

Mesa de cabeleireiro BOHEMIAN



La Fauteuil de coiffure BOHEMIAN a un design actuel qui combine des lignes courbes et droites, en noir et ayant des finitions en argent. Conçue pour donner un maximum de confort. La Fauteuil dispose d'une pompe hydraulique qui vous permet de soulever et d'abaisser le siège, de sorte que vous pouvez placer le client à la hauteur qui convient le mieux à chaque travail. Combinable avec 3 pieds. Option repose-pieds disponible.

O mesa de cabeleireiro BOHEMIAN tem um design vintage que combina linhas curvas, de cor preta e costuras brancas, pensadas para dar a máxima comodidade. O mesa tem uma bomba hidráulica que permite subir e baixar o assento, desta forma poderá situar o cliente à altura que se adapte melhor a cada trabalho. Combinável com 3 pés, e com a opção de repouso-pés.

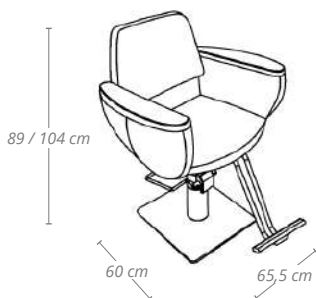

REF.06093/50/2 REF.06093/50/5*



REF.06093/50/3 REF.06093/50/6*



REF.06093/50/1 REF.06093/50/4*

*Avec repose-pieds
*Com apoio para os pés

Fauteuil de coiffure ART

Assento de cabeleireiro ART



La Fauteuil de coiffure ART a un design moderne qui combine des lignes courbes, en noir et ayant des finitions en argent. Conçue pour donner un maximum de confort. La Fauteuil dispose d'une pompe hydraulique qui vous permet de soulever et d'abaisser le siège, de sorte que vous pouvez placer le client à la hauteur qui convient le mieux à chaque travail. Combinable avec 3 pieds. Option repose-pieds disponible.

O mesa de cabeleireiro ART tem um design atual que combina linhas curvas e retas, de cor preta e com acabamentos em prata, pensado para dar a máxima comodidade. A cadeira tem uma bomba hidráulica que permite elevar e abaixar o assento, para que você possa colocar o cliente na altura mais adequada para cada trabalho. Combinável com 3 pés e com a opção de apoio para os pés.

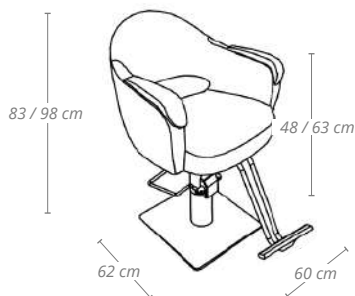

REF.06094/50/2 REF.06094/50/5*



REF.06094/50/3 REF.06094/50/6*



REF.06094/50/1 REF.06094/50/4*

*Avec repose-pieds
*Com apoio para os pés

Lave-tête portable gonflable

Lava-cabeças portátil insuflável



REF.03923

Lave-tête portable

Lava-cabeças portátil



REF. 04838/50

REF. 04838/70

REF. 04838/54

Lave-tête portable avec pied et siphon

Lava-cabeças portátil com pé, e saída de água



REF. 03736



* Le détail prend en charge les shampooings
* Detalhe suporta champôos

Lave-tête portable

Lava-cabeças portátil

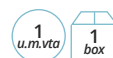

REF.01970

» Pied réglable en hauteur
» Siphon 50 cm
» Non-inclinable

» Pé regulável em alturaa
» Saída de água 50 cm
» Não basculante



REF. 03736/68



REF. 03736/54

» Avec pied et système d'écoulement.
» *Avec une cavité pour les shampooings

» Com pé e tubo de saída de água.
» *Com cavidade para champôs

Réservoir pour lave-têtes

Depósito para lava-cabeças



250 ml

REF.03737



Convient avec les modèles
Apto para estes modelos



REF. 03736



REF. 01970

Bac lavage LACACOM

Rampa de lavagem LAVACOM

2 u.m.vta
2 box



Bac de lavage en matériau très léger, facile à monter, réglable en hauteur et très pratique pour le shampoing des personnes à mobilité réduite ou pour des services à domicile.

Design de linhas modernas, mas ao mesmo tempo oferece a máxima comodidade. Inclui apoio para pernas para um maior conforto do cliente.

REF.06952

REF.06952/00

1 u.m.vta
1 box

Bac lavage portable Eurostil avec attelage arrière
Rampa de lavagem portátil Eurostil com engate traseiro

Bac lavage portable avec attelage arrière. Anonyme.

Rampa de lavagem portátil com engate traseiro. Anônimo



REF.RE06952/04



REF.RE06952/04/00

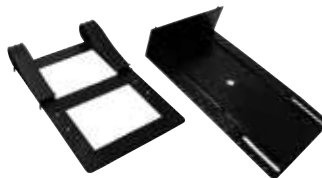

REF.RE06952/05



Boîte 2 plateaux Eurostil
Caixa 2 bandejas Eurostil

Boîte 2 plateaux anonymes
Caixa 2 bandejas anónimas

Boîte de 2 crochets pour dossier
Caixa de 2 ganchos para encosto

Chariot auxiliaire

Mesa auxiliar

1 u.m.vta
1 box

Gio

REF.02366/50

Jolly

REF.00874

Black

REF.03215



Table auxiliaire ajustable
Mesa auxiliar regulável

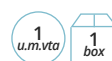

REF.03843

» Avec plaque en
acier inoxydable

» Com prato de aço
inoxidável



Chariot 2 plateaux pour coloration
Carrinho 2 bandejas para coloração



REF.03181

» Chariot spécial pour tous les types de travaux de teinture et de décoloration.

» Avec capacité pour plusieurs shakers, bols et un endroit spécial pour la feuille d'aluminium nécessaire pour les mèches.

» Léger et très maniable

» Roues co-pivotantes pour un meilleur mouvement

» Carrinho especial para todo tipo de trabalhos de coloração e descoloração.

» Com capacidade para várias misturadoras, malgas, e um alojamento especial para o papel de alumínio necessário para as madeixas.

» Ligeiro e muito manejável

» Com rodas giratórias para uma melhor deslocação.



Chariot en bois modèle SWING
Carrinho madeira mod. SWING

Chariot avec deux corps noirs et 3 tiroirs respectivement (6 au total). Il se compose de 4 roues pour être plus à l'aise lors du déplacement. Le plateau supérieur dispose de beaucoup d'espace et contient plusieurs trous conçus pour déposer différents objets. Il comprend également un support en métal pour supporter le séchoir.

Carrinho com 6 gavetas. 4 rodas para ser mais confortável ao movê-lo. A bandeja superior tem muito espaço e contém vários buracos projetados para depositar objetos diferentes. Também inclui um suporte de metal para suportar o secador.



REF.06279

Chariot pour appliquer des colorations
Carrinho coloração

- » Chariot spécial pour tous les types de travaux de teinture et de décoloration
- » Avec capacité pour plusieurs palettes, shakers, bols et deux rangements spéciaux pour feuille d'aluminium.
- » Léger et très maniable.
- » Avec des roues rotatives pour un meilleur mouvement.

- » *Carrinho especial para todo tipo de trabalhos de coloração e descoloração*
- » *Com capacidade para várias paletas, misturadoras, malgas e dois alojamentos especiais para o papel de alumínio.*
- » *Ligeiro e muito manejável.*
- » *Com rodas giratórias para uma melhor deslocação.*



REF.03180

Chariot de coiffure MASTER UP
Carrinho cabeleireiro MASTER UP

REF.01963/50

Chariot en bois modèle ZEPHIR
Carrinho madeira mod. ZEPHIR

REF.01331

Chariot de coiffure Carrinho cabeleireiro

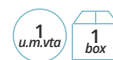

Mod. Boy

REF.00877

Mod. Smile

REF.04380

Mod.Funny

REF.04381



Chariot de coiffure TIM Carrinho cabeleireiro TIM

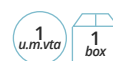

- » Chariot avec 6 caxetes amovibles et interchangeables
- » Rangements pour mettre des tubes, des bols et des sèche-cheveux
- » Matériel polypropylène

- » Carrinho de apoio com 6 gavetas extraíveis
- » Com espaço indicado para colocar tubos e secadores de cabelo
- » Material polipropileno



REF.04276/50

Douchette avec support
Chuveiro com suporte

1 u.m.vta
20 box

REF.03004



Kit de douchette adaptable
Kit chuveiro adaptável

1 u.m.vta
10 box

REF.01960



Mitigeur monocommande pour bac à douchette
Mono-comando para rampa lavagem

1 u.m.vta
50 box

REF.02837



Pommeau de douche ionique
Chuveiro iônico

1 u.m.vta
36 box

REF.03750



Économie d'eau
Meilleure qualité de l'eau.

Poupa água.
Melhora a qualidade da água.

Étagère rangement de serviettes
Organizadores para pendurar toalhas

1 u.m.vta
6 box

REF.04378



Conteneur de serviettes
Contentor toalhas

1 u.m.vta
4 box

REF.03159



» Avec des roues
Housse conteneur
lavable. Structure en
acier inoxydable

» Com rodas
» Bolsa contentora
lavável
» Estrutura de aço
inoxidável

08

Peignes et brosses

ESCOVAS
E PENTES

*Peignes, brosses, pinceaux, brosse
thermique, étuis de coiffeur, présentoirs...*

*Pentes, escovas, pincéis, escovas térmicas,
kits de cabeleireiro, expositores...*



Brosses à crêper
Escovas de crepar

- » Poils en nylon
- » Cerdas de nylon



REF.00105/50

- » Poils de sanglier
- » Cerdas de javali



REF.02452

- » Poils de sanglier
- » Cerdas de javali



REF.04528

3 rangées de cheveux, la rangée centrale la plus haute
3 linhas de cabelo, a linha central mais alta

- » Poils en nylon
- » Cerdas de nylon



REF.00106



REF.00106/58

- » Poils de sanglier
- » Cerdas de javali



REF.03171



REF.03171/58

- » Pics droits en plastique
- » Pua de plástico reta



REF.03880



REF.03880/58

- » Poils de sanglier
- » Cerdas de javali



REF.03227

Brosse en bois. Corps incurvé pour une meilleure adaptation
Escova de madeira. Corpo curvado para melhor adaptação

- » Pics en métal arrondis
- » Pua de metal com bola



REF.00161

Brosses spirales avec manche en plastique

Escovas espiral cabo plástico punho de plástico



1 u.m.vta
50 box

REF. 01851



NYLON

Ø 20



1 u.m.vta
40 box

REF. 01598



NYLON

Ø 25



1 u.m.vta
12 box

REF. 02995

» Poils de sanglier

» Cerdas de javali



Ø 10



Brosses spirales avec manche en bois

Escovas espiral punho de madeira

1 u.m.vta
72 box

REF. 00351



NYLON

Ø 25



1 u.m.vta
30 box

REF. 00502



NYLON

Ø 25



1 u.m.vta
30 box

REF. 01597



NYLON

Ø 32



Brosses circulaires en bois

Escovas circular de madeira



NYLON

» Poils en nylon
» Cerdas de nylon

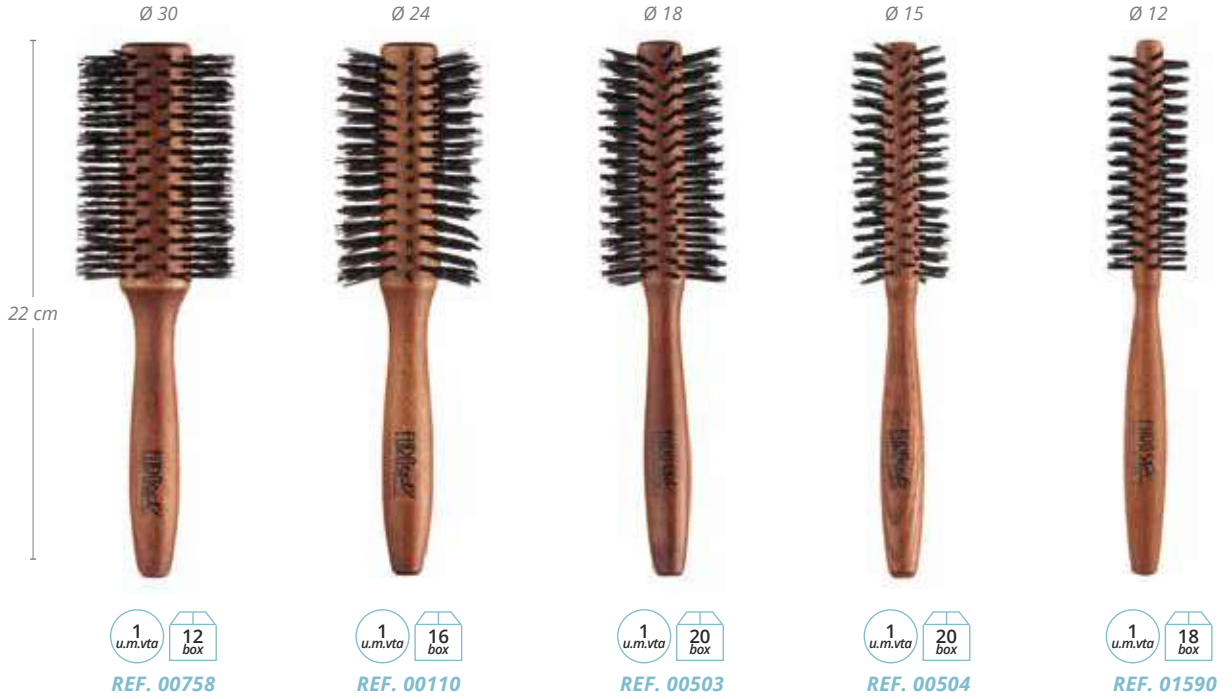

Brosse circulaire en bois

Escovas circular de madeira



NYLON



» Poils en nylon + sanglier
» Cerdas de nylon + javali

REF. 02178



Ø 63

Brosses circulaires en bois

Escova circular de madeira



» Poils en nylon + sanglier
» Cerdas de nylon + javali



Brosses circulaires en bois

Escova circular de madeira



- » Poils en naylon arrondis
- » Cerdas de naylon com bola



Brosses circulaires en bois

Escova circular de madeira



- » Poils de sanglier
- » Cerdas de javali

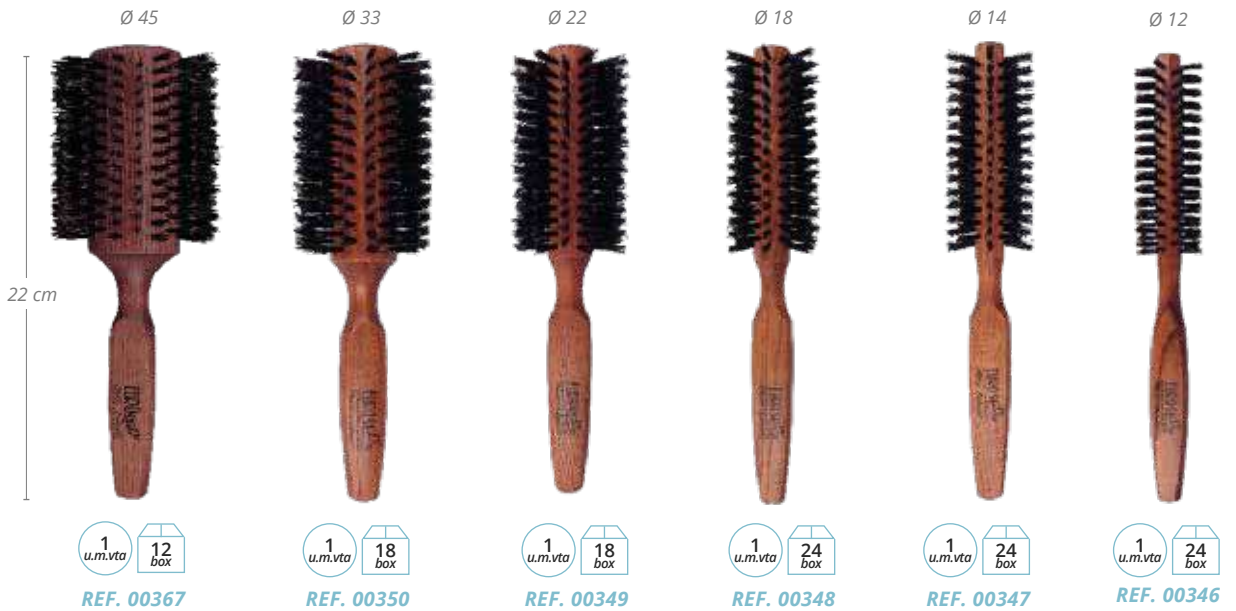

Brosse circulaire en bois avec manche en caoutchouc
Escova circular de madeira com punho de borracha



» Poils en nylon + sanglier
 » Cerdas de nylon + javali

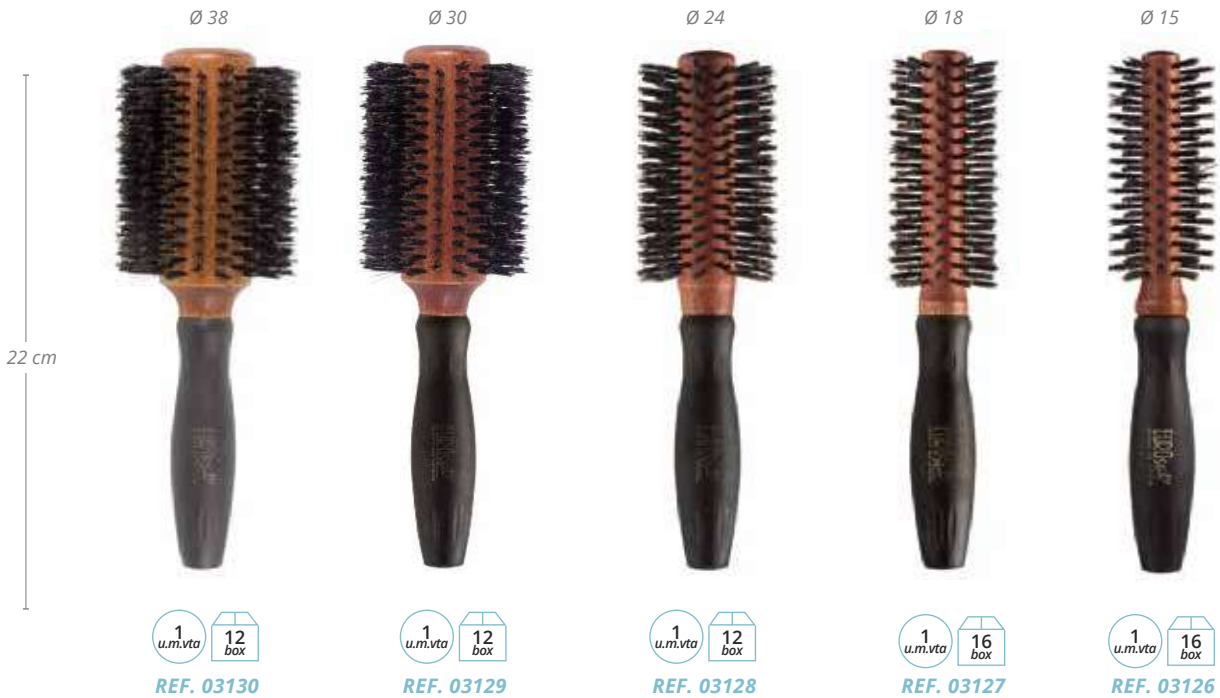

Brosses pneumatiques avec manche en bois
Escova com fole e punho de madeira



» Poils de sanglier
 » Cerdas de javali



REF. 00328



REF. 00327



REF. 00352



REF. 00326



REF. 00325

Brosses pneumatiques avec manche en bois
Escova com fole e punho de madeira



» Poils en nylon + sanglier
 » Cerdas de nylon + javali



REF. 00528



REF. 00529

Brosse pneumatiques avec manche en bois

Escova pneumática com punho madeira



» Poils en plastique
» Cerdas de plástico



12 u.m.vta 12 box

REF. 00590

12 u.m.vta 12 box

REF.00597



12 u.m.vta 12 box

REF. 01994

12 u.m.vta 12 box

REF.03298

12 u.m.vta 12 box

REF.03299

» Brosse confortable
» Démêlage facile
» Ergonomique et légère
» Classique et élégante

» Escova confortável
» Desembaraço fácil
» Ergonômico e leve
» Clássico e elegante

Présentoir en bois 20 brosses

Expositor de madeira com 20 escovas

1 u.m.vta 4 box

REF.03387



Brosses pneumatiques avec manche en bois

Escova pneumática com punho de madeira



METAL

- » Pics en métal arrondis
- » Pua de metal com bola



REF. 00146



REF. 00148



REF. 00147

Brosses en bois de bambou

Escova de bambu



WOOD



- » La brosse et les dents sont en bois naturel de bambou
- » Production de bois contrôlé
- » Brosse antistatique
- » Rend les cheveux doux et soyeux
- » Bois très résistant et flexible

- » Corpo escova e pêlos de madeira natural de bambu
- » Produção da madeira controlada
- » Escova anti estática
- » Proporcionam brilho e suavidade ao cabelo
- » Madeira muito resistente e flexível



REF. 03223



REF. 03224



REF. 03225



REF. 03226

Brosse pneumatiques avec manche en bois
Escova pneumática com punho de madeira



WOOD
 » Pics de bois
 » Pua de madeira



REF. 01922



REF. 01921



REF. 01920



REF. 01919

Brosse pneumatiques avec manche en bois
Escova pneumática com punho de madeira

NYLON
 » Poils en nylon
 » Cerdas de nylon



1 u.m.vta / 70 box

REF. 01924

Petit
 Pequeno



1 u.m.vta / 50 box

REF. 01923

Grand
 Grande



Brosse pneumatique de type palette
Escova pneumática paddle

PLASTIC
 » Picots en plastique
 » Bois



» Cerdas de plástico
 » Madeira

REF. 02463/99



Brosses pneumatiques pour démêler
Escova pneumática desembaraçar



PLASTIC

» Poils en plastique à pointes arrondies
 » Pua de plástico com bola



REF. 04282



REF. 04281



REF. 04280



REF. 04279



Brosses pneumatiques avec manche en plastique
Escova pneumática com punho de plástico



» Poils de sanglier et nylon
 » Cerdas de javali e nylon



REF. 03691



REF. 03690



REF. 03693



REF. 03689

Brosses pneumatiques avec manche en plastique
Escova pneumática com punho de plástico



» Poils de sanglier et nylon
 » Cerdas de javali e nylon



REF. 01472



REF. 01471

Brosses pneumatiques avec manche en plastique

Escova pneumática com punho de plástico



» Poils de sanglier
» Cerdas de javali

PLASTIC

» Poils en plastique
» Cerdas de plástico

PLASTIC

» Poils en plastique à pointes arrondies
» Pua de plástico com bola



1 u.m.vta
12 box

REF. 00767



1 u.m.vta
12 box

REF. 00793



1 u.m.vta
24 box

REF. 00755

Brosse professionnelle ovale

Escova profissional ovalada



1 u.m.vta

18 box

REF. 00337

PLASTIC

» Poils en plastique à pointes arrondies
» Pua de plástico com bola



Brosses pneumatiques avec manche en plastique

Escova pneumática com punho de plástico



METAL

- » Pics en métal arrondis
- » Pua de metal com bola

1 u.m.vta 36 box

S

REF. 00158/50



REF. 00158



1 u.m.vta 24 box

M

REF. 00159/50



REF. 00159



1 u.m.vta 24 box

L

REF. 00160/50



REF. 00160



Brosses pneumatiques avec manche en plastique

Escova pneumática com punho de plástico



METAL

- » Pics en métal arrondis
- » Brosse antistatique
- » Pua de metal com bola
- » Escova anti estática

1 u.m.vta 12 box

REF. 00587



1 u.m.vta 12 box

REF. 00586



Brosses pneumatiques avec manche en plastique
Escova pneumática com punho de plástico



NYLON

» Poils en nylon
 » Cerdas de nylon



Brosses pneumatiques avec manche en plastique
Escova pneumática com punho de plástico



NYLON

» Poils en nylon arrondis
 » Pua de nylon com bola



Brosses pneumatiques avec manche en plastique

Escova pneumática com punho de plástico



- » Poils de sanglier
- » Cerdas de javali



1 u.m.vta
12 box
S

REF. 00303



1 u.m.vta
12 box
M

REF. 00304



1 u.m.vta
12 box
L

REF. 00305

Brosses pneumatiques avec manche en plastique

Escova pneumática com punho de plástico



- » Poils en plastique
- » Pua de plástico

- » Poils en plastique à pointes arrondies
- » Pua de plástico com bola

- » Poils en plastique à pointes arrondies
- » Pua de plástico com bola

- » Poils en plastique à pointes arrondies
- » Pua de plástico com bola



1 u.m.vta
18 box

REF.00309



1 u.m.vta
24 box

REF. 00155/50



1 u.m.vta
24 box

REF. 00156/50



1 u.m.vta
36 box

REF. 00157/50

Brosses pneumatiques avec manche en plastique
Escova pneumática com punho de plástico



» Poils en nylon
 » Cerdas de nylon



» Poils de sanglier
 » Cerdas de javali



REF. 03091



REF. 03088



REF. 03092



REF. 03089

Brosses pneumatiques avec manche en plastique
Escova pneumática com punho de plástico



» Poils en plastique arrondis
 » Cerdas de plástico com bola



REF. 03093



REF. 03090

Brosses pneumatiques avec manche en caoutchouc
Escova pneumática com punho de borracha



» Poils en plastique arrondis
 » Cerdas de plástico com bola

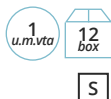

REF. 03101



REF. 03098

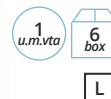

REF. 03103

Brosses pneumatiques avec manche en caoutchouc
Escova pneumática com punho de borracha



» Poils de sanglier
 » Cerdas de javali



REF. 03100

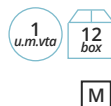

REF. 03308

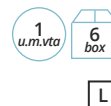

REF. 03102

Brosses pneumatiques avec manche en caoutchouc

Escova pneumática com punho de borracha



NYLON

- » Poils en nylon
- » Cerdas de nylon



1
u.m.vta

12
box

REF. 03309



1
u.m.vta

12
box

REF. 03099

Brosses pneumatiques avec manche en caoutchouc

Escova esqueleto com punho de borracha

1
u.m.vta

12
box

PLASTIC

- » Poils en plastique arrondis
- » Cerdas de plástico com bola



S

REF. 03095



L

REF. 03094

Brosses thermiques

Escovas térmicas

- » Les brosses thermiques Bimatières sont également disponibles

- » Também disponíveis
- » escovas térmicas

PÁG.236



REF. 03349



REF. 03348



REF. 03347



REF. 03346

Brosses pneumatiques

Escovas pneumáticas



» Poils en plastique arrondis
» Cerdas de plástico com bola



REF.03202



Brosses pneumatiques qui s'adaptent parfaitement à la forme de la tête pour un brossage large et doux. Les dents en plastique avec une finition en forme de boulette de la même couleur que la brosse. Manche confortable et agréable à utiliser

Escovas pneumáticas que se adaptam perfeitamente à forma da cabeça proporcionando um efeito de escovagem amplo e suave. Dentes em plástico com terminação em bolita da mesma cor que a escova. Punho cómodo e de uso agradável.



Brosses 03881**Escova 03881**

REF. 03881



- » 3 hauteurs de dents. (120 petites, 123 moyennes, 119 grandes)
- » Manche ergonomique
- » Flexible et lisse mais efficace
- » Thermoplastique de 1ère qualité.
- » Pour les cheveux mouillés ou secs
- » NE casse PAS les cheveux
- » Légère et confortable à utiliser.
- » Avec peu de charge statique
- » Résistante aux produits chimiques
- » Avec courbure pour mieux s'adapter à la tête
- » Brosses bicolores (couleurs assorties)

- » 3 alturas de dentes. 120 dentes pequenos. 123 dentes médios. 119 dentes grandes
- » Punho ergonómico
- » Flexível e suave mas eficiente
- » Termoplástico de 1ª qualidade
- » Para cabelo molhado ou seco
- » NÃO quebra o cabelo
- » Ligeira e cómoda de usar
- » Com pouca carga estática
- » Resistente aos produtos químicos
- » Com curvatura para adaptar-se melhor à cabeça
- » Escovas bicolores (cores sortidas)



REF. 03881/97



Présentoir de brosses pour démêler Expositores escova desembaraçar

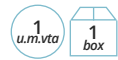

» Couleurs assorties
» Cores sortidas

REF.04875

» Métalliques
couleurs
» Cores metálicos

REF.04875/97

REF.04875/01



Brosse sphérique 3D Escova esférica 3D



PLASTIC

REF. 04968

Brosse sphérique 3D. Empêche les cheveux de s'emmêler
conception sphérique à 360°. Permet de créer des
boucles et des vagues. Ses dents espacées permettent
une meilleure circulation de l'air en réduisant le temps de
séchage de moitié.

Escova esférica 3D. Evita que o cabelo fique emaranhado
Pode ser girado em 360° para criar cachos e ondas. Seus
dentes espaçados permitem melhor circulação de ar,
reduzindo o tempo de secagem pela metade.



Brosses en couleurs pour démêler des cheveux

Escova desembaraçar cores misturadas



» Poils en plastique
» Pua de plástico

PLASTIC

S

REF. 04600



Présentoirs de brosses pour démêler

Expositores escova desembaraçar



STOP aux secousses, STOP aux enchevêtrements, ARRÊTER les frisottis

PARE empurrões, PARE emaranhados, PARAR o frizz



L

REF. 04562



S

REF. 04886



L

REF. 04885



Présentoir de 12 brosses Special Detangler à démêler. Avec des picots très flexibles de différent hauteur. Démêler mêmes les nœuds sans. Chaque présentoir dispose de 4 tirages ou dessins exclusifs.

Expositor com 12 escovas especiais Detangler para desembaraçar. Com picos muito flexíveis em diferentes níveis que ajudam a desfazer até nós sem condicionador. PARE os enredamentos, PARE a ondulação. Cada expositor tem 4 estampas ou desenhos exclusivos.

Présentoir de 20 brosses en bois
Expositor 20 escovas de madeira



- » Pics droits en plastique
- » Púa de plástico reta

WOOD

REF.03387



Comprend 4 unités
 par référence

Inclui 4 unidades
 por referência,

REF. 03299
 REF. 03298
 REF. 00590
 REF. 01994
 REF. 00597

Présentoir de 12 brosses rectangulaires en bois
Expositor 12 escovas retangulares de madeira



- » Pics droits en plastique
- » Púa de plástico reta

WOOD

REF.01166



Comprend 12 unités
 Inclui 12 unidades

REF. 00590

Présentoir de 12 grandes brosses pneumatiques
Expositor 12 escovas pneumática, grande



- » Poils en nylon
- » Cerdas de nylon

NYLON

REF.01165



Comprend 12 unités
 Inclui 12 unidades

REF. 00133



Présentoir de 20 brosses thermiques
Expositor 20 escovas térmicas



» Poils en nylon
 » Cerdas de nylon

REF.01176



Comprend 4 unités
 par référence

Inclui 4 unidades
 por referência,

REF. 00579
 REF. 00580
 REF. 00581
 REF. 00582
 REF. 00780

Présentoir de 12 brosses araignée
Expositor 12 escovas "esqueleto túnel"



» Poils en plastique arrondis
 » Cerdas de plástico com bola

REF.01167



Comprend 12 unités
 Inclui 12 unidades

REF. 01165



Présentoir de 24 brosses thermiques
Expositor 24 escovas térmicas



» Poils en nylon
 » Cerdas de nylon

REF.07431



NEW

Comprend 4 unités
 par référence

Inclui 4 unidades
 por referência

REF. 03355
 REF. 03356
 REF. 03357
 REF. 03358
 REF. 03359
 REF. 03360

Brosses araignée de couleurs

Escovas esqueletos cores

PLASTIC

- » Picots en plastique arrondis
- » Cerdas de plástico com bola

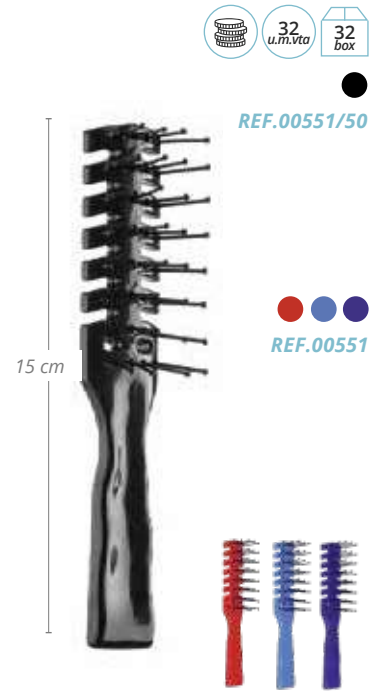
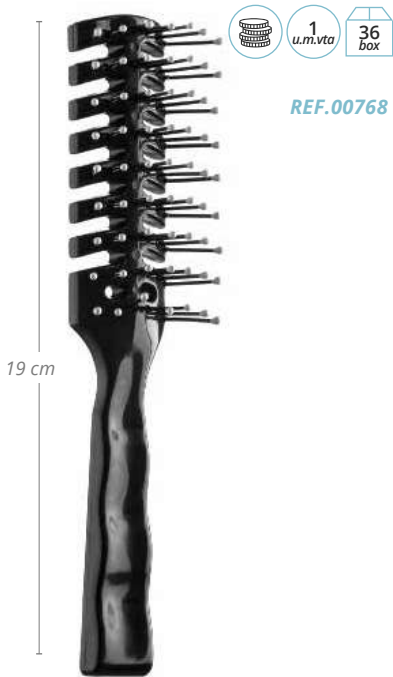

Brosses araignée

Escovas esqueletos

PLASTIC

- » Picots en plastique arrondis. Couleurs assorties
- » Cerdas de plástico com bola. Cores sortidas

20 u.m.vta 20 box

REF.00550/97



Brosses araignée de couleurs en caoutchouc
Escovas esqueletos, cores sortidas, de plástico



- » Picots en plastique arrondis
- » Cerdas de plástico com bola

REF.00575

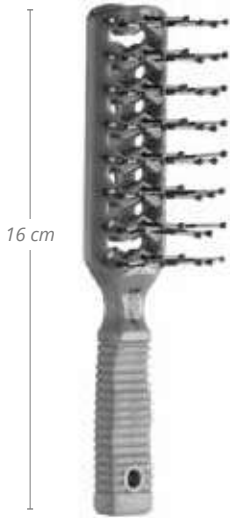

REF.00574

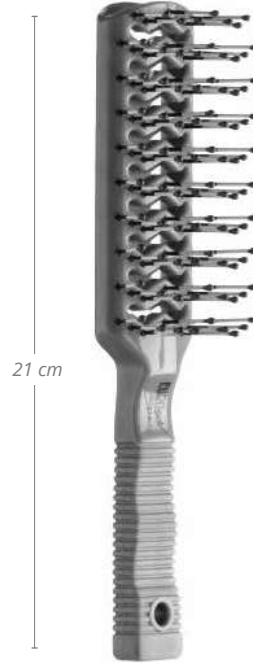

REF.00576



REF.00754

21 cm



Brosses araignée Escovas esqueletos

PLASTIC

» Picots en plastique arrondis
» Cerdas de plástico com bola

12
u.m.vta12
box

S

REF.03087

12
u.m.vta12
box

L

REF.03086

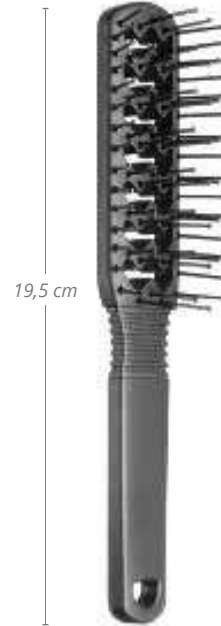
1
u.m.vta16
box

REF. 02203/50

REF. 02203



Brosses araignée ANTISTATIQUE Escovas esqueletos ANTIESTÁTICO

PLASTIC

» Picots en plastique arrondis
» Cerdas de nylon com bola

S

REF.00585



17,50 cm

L

REF.00584

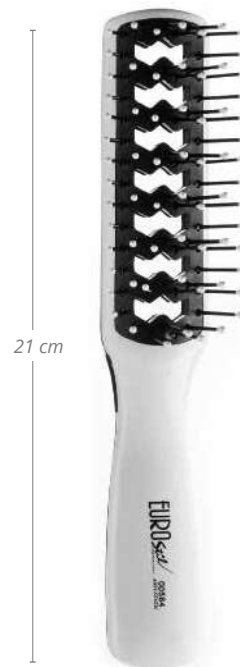

21 cm

1
u.m.vta12
box

Brosses araignée de couleurs Escovas esqueletos cores diferentes

PLASTIC

» Picots en plastique
» Cerdas de plástico



Brosses araignée flexibles Escovas esqueletos flexíveis

PLASTIC

» Picots en métal arrondis
» Pua de metal com bola

1 u.m.vta 12 box

S
REF. 04405

L
REF. 04406



Brosses araignée courbes de couleurs

Escovas esqueletos curvos cores diferentes

PLASTIC

- » Picots en plastique arrondis
- » Cerdas de plástico com bola

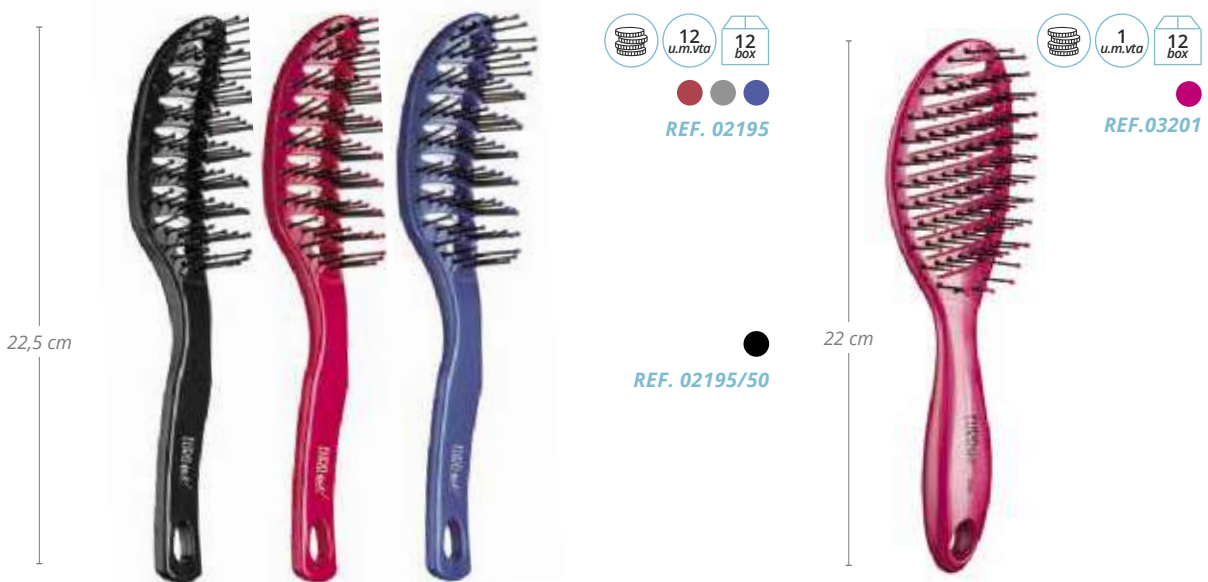

Brosses courbes pour une meilleure adaptation à la forme de la tête, légère et confortable à utiliser pour son design ergonomique. 11 rangées de dents en forme anatomique, en plastique avec une finition en forme de boulette de la même couleur que la brosse.

Escovas curvas para uma melhor adaptação à forma da cabeça, ligeiras e cómodas de utilizar pelo seu design ergonómico. 11 filas de dentes em forma anatómica, em plástico. Com terminação em bolita da mesma cor que a escova.

Brosses araignée doubles couleurs

Escovas esqueletos duplos cores

PLASTIC

- » Picots en plastique arrondis. Couleurs assorties
- » Cerdas de plástico com bola. Cores sortidas.

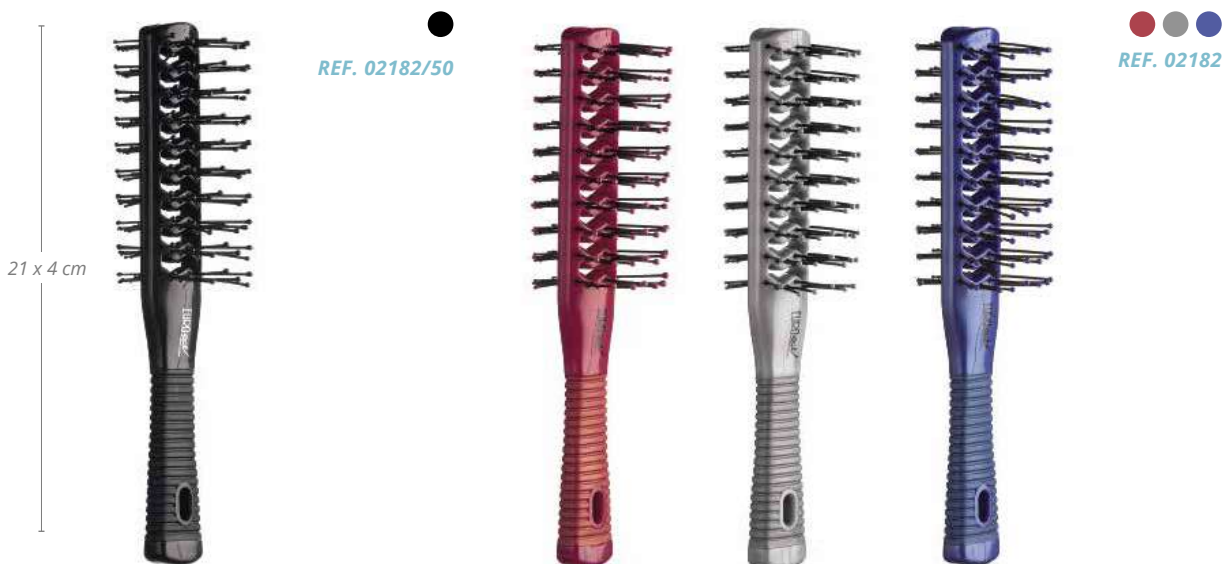

Petite brosse démêlante

Escova para desembaraçar



- » Picots de deux hauteurs
- » Cerdas de dupla altura



REF.06609

- » Ligne de brosses spécialement développée pour les cheveux cassés
- » Linha de capelas especialmente desenvolvida para cabelos quebrados.



REF.06610



16,5 cm



21 cm

Brosse plate en plastique

Escova plástico



- » Picots en plastique arrondis
- » Cerdas de plástico com bola



REF.00571



REF.00570



Brosse plate en caoutchouc

Escova plana, de plástico



- » Picots en plastique
- » Cerdas de plástico

REF. 04700

Brosse pliante avec miroir

Escova espelho dobrável



- » Picots en plastique arrondis
- » Cerdas de plástico com bola

REF.00329

REF.00329/50



Brosse plate en plastique

Escova plástico



- » Poils en plastique
- » Cerdas de plástico

REF.01850/50

REF.01850



Brosse curling
Escova de ondulação



REF.00386



Peigne professionnel pour brushing
Escova profissional para ferro



REF. 03262



Brosse thermique de lissage double
Escova térmica dupla, alisar



REF. 01957

- » Poils de sanglier
- » Cerdas de javali

REF. 02365



Peignes spéciaux anti-poux Pentes fins



PLASTIC

- » Peigne spécial en polypropylène
- » Picots de plastique

- » Pente fino de polipropileno
- » Cerdas de plástico

REF. 00443

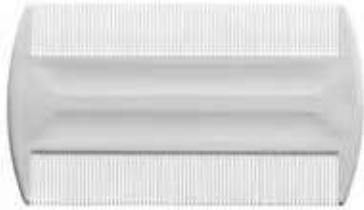

REF. 00443/50

Peignes spéciaux anti-poux Pentes fins



METAL

- » Picots en métal
- » Cerdas de metal

REF.03305



Brosse et peigne pour bébé Escova e pente bebé



REF.00670

REF.00670/75

REF.00670/70



Peigne avec niveaux**Pente com nível**

Le peigne avec niveau permet de faire une coupe ou un dégradé parfaite grâce à ses 3 niveaux.

Graças aos seus três níveis, permite realizar cortes ou desbastes em linha reta.



REF. 04349

» Brosse de nettoyage peigne
» Escova de limpeza pentes



REF. 00600

» Brosse et peigne couleur argent
» Conjunto de escova e pente prateado



REF. 03488

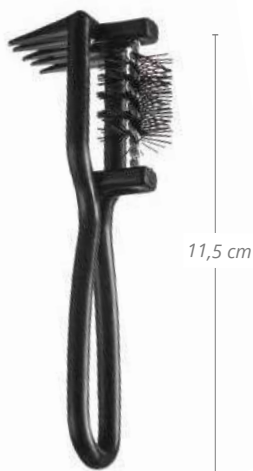

Brosses thermiques céramique-ionique manche en caoutchouc
Escova térmica de cerâmica-iônica com punho de plástico



NYLON

- » Picots en nylon
- » Dent amovible
- » Avec cintre

- » Cerdas de nylon
- » Dente removível
- » Com colgador



1 u.m.vta
24 box

REF. 02312



1 u.m.vta
24 box

REF. 02313



1 u.m.vta
20 box

REF. 02314



1 u.m.vta
20 box

REF. 02315



1 u.m.vta
16 box

REF. 02316

Brosses thermiques manche en plastique tube aluminium fermé
Escova térmica com punho de plástico



NYLON

- » Brins en nylon
- » Avec cintre

- » Cerdas de nylon
- » Com colgador

TUBE ALUMINIUM FERMÉ
TUBO FECHADO ALUMINIO

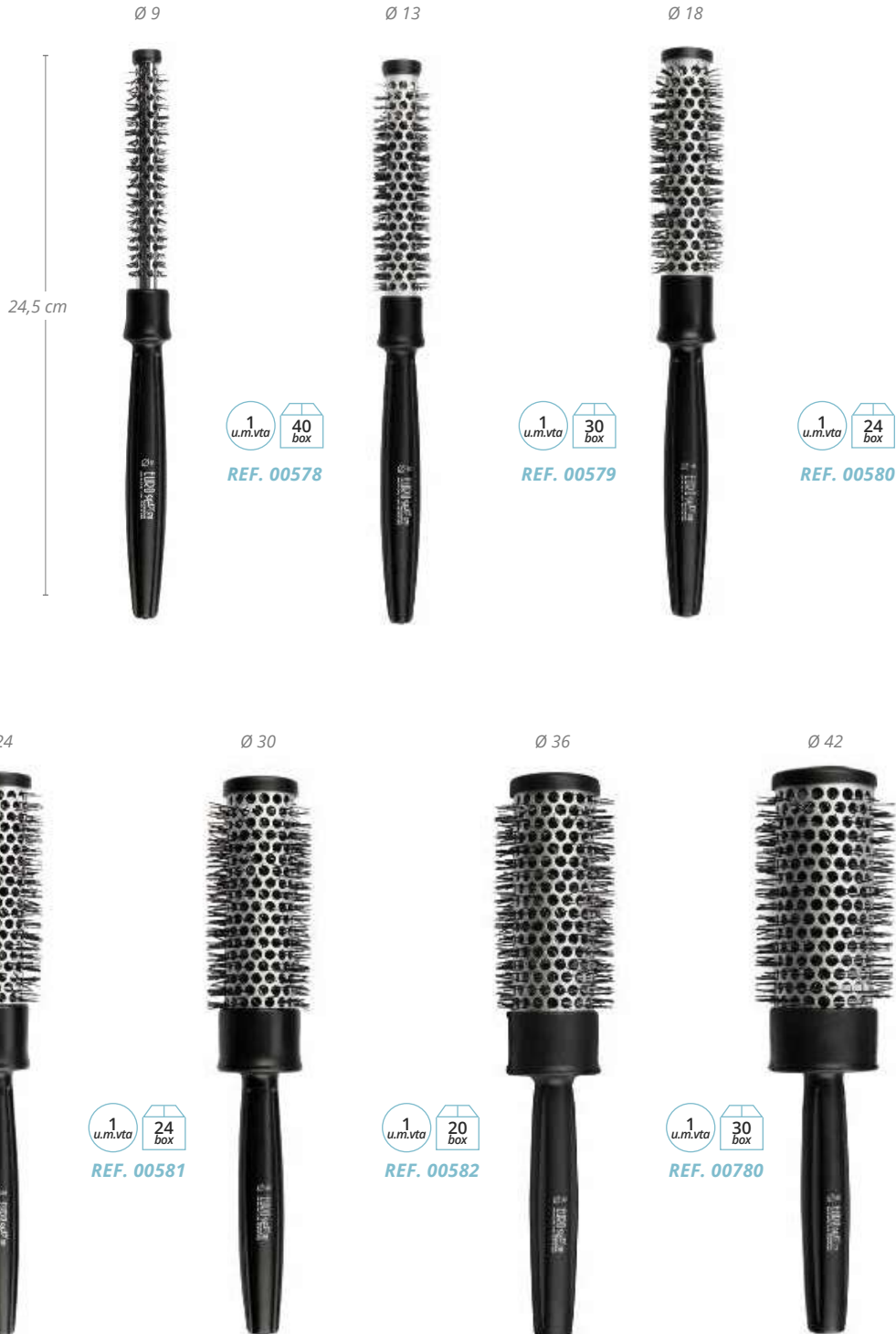

Brosses thermiques manche en plastique tube aluminium ouvert
Escova térmica com punho de plástico aberto



- » Brins en nylon
- » Avec cintre

- » Cerdas de nylon
- » Com colgador

Ø 13



24,5 cm

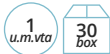

REF. 00355

Ø 18



REF. 00356

Ø 24



REF. 00357

Ø 30



REF. 00358

Ø 36



REF. 00359

Ø 42



REF. 00360

Ø 50



REF. 02661

Ø 61

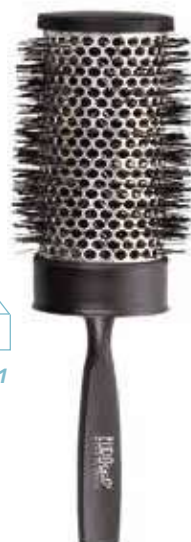

REF. 02662

Brosses thermiques aluminium manche en caoutchouc

Escova térmica em alumínio com punho de plástico



NYLON

- » Brins en nylon
- » Avec cintre

- » Cerdas de nylon
- » Com colgador



Brosses thermiques en céramiques manche en bois

Térmicos cerâmicas com punho de madeira



NYLON

Les brosses thermiques en céramique de dernière génération sont dotées d'un corps central en aluminium recouvert de céramique pour assurer une résistance élevée à la chaleur et une répartition uniforme de la chaleur dans tout le corps de la brosse.

- » Poils en nylon
- » Avec cintre

As escovas térmicas de cerâmica de última geração têm um corpo central de alumínio coberto de cerâmica para assegurar uma alta resistência ao calor e uma distribuição uniforme do calor ao longo do corpo da escova.

- » Cerdas de nylon
- » Com colgador



Brosses thermiques avec poignée en bois

Escova térmica com punho de madeira



Le corps de la brosse est métallique et en bois
 O corpo do pincel é metálico e de madeira

» Sanglier à 2 niveaux et pointes en nylon pour améliorer le maintien des cheveux.
 Ligne de pinceaux développée en Espagne pour des cheveux denses et volumineux.

» Javali de 2 níveis e pontas de nylon para melhorar o apoio ao cabelo. Linha de pincéis desenvolvidos na Espanha para cabelos densos e volumosos.



Brosse thermique circulaire en caoutchouc

Escova térmica circular de borrach



» Poils en nylon + sanglier
 » Cerdas de nylon + javali



Peignes professionnels de couleurs EUROSTIL
Pentes profissionais cores sortidas EROSTIL



REF. 04616

REF. 04616/97

REF. 04616/98

REF. 04616/99



Peigne choix spécial
Batedor de pente escolha especial



REF. 00441

REF. 00441/98

REF. 00441/99



Peigne spécial
Pente batidor especial



REF. 00442

» Renforcé
 » Reforçado

REF. 00424

» Super long
 » Superlargo

REF. 01470



17,5 cm



18,5 cm



21,5 cm

Peigne spécial
Pente batidor especial



REF. 00115

REF. 00115/97

REF. 00115/98

REF. 00115/99



17,5 cm



Peigne spécial
Pente batidor especial

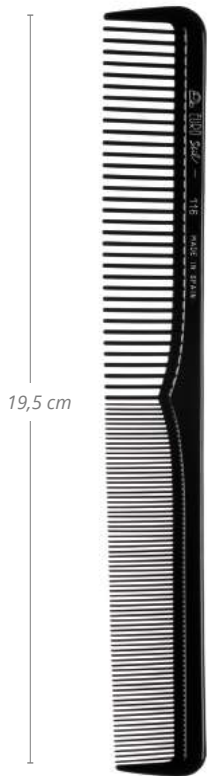

REF. 00116



REF. 00116/97



REF. 00116/98



REF. 00116/99



Peigne spécial de coiffeur
Pente especial cabeleireiro

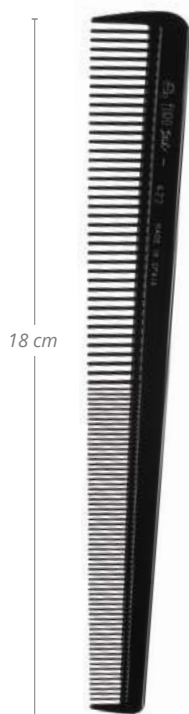

REF. 00422



REF. 00422/98



REF. 00422/99



REF. 00422/58



Peigne spécial
Pente batidor especial



» Double broche haute
 » Pino alto duplo



REF. 00423



REF. 00423/97



REF. 00423/98



REF. 00423/99

20,5 cm



Peigne à dents en nylon
Pente dentes nylon



REF. 00114



REF. 00114/99

20,5 cm



Peigne à dents larges en métal
Pente dentes largas metal



REF. 00118

REF. 00118/99



Peigne dents en métal
Pente dentes metal



REF. 01467



REF. 01468

» Pointes larges
 » Pontas largas

Peigne incurvé noir à dents creuses
Pente dentes largos ferro



REF. 00127/50



REF. 00404/50

Peigne spécial à 5 dents en métal
Pente 5 dentes metal especial



REF. 01469



REF. 01469/98



REF. 01469/99



Peigne creux à 5 dents en fer
Pente 5 dentes pins largos ferro



REF. 00128



REF. 00128/98



REF. 00128/99



» Peigne de coupe spécial pour
 tondeuse professionnelle



REF. 02472

» Peigne professionnel
 » Pente profissional batidor



REF. 02304

» Pente de corte especial para
 máquina de corte profissional

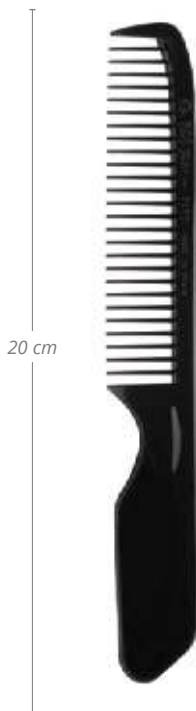

Peigne pour les mèches
Pente batidor madeixas



REF. 00455



REF. 00455/99



Peigne recto
Pente batidor reto



REF. 00454



REF. 00454/99



Peigne EUROSTIL professionnel
Pente EUROSTIL profissional

- » Peigne double dent en plastique
- » Pente batidor plástico dupla fileira de dentes



REF. 00452



18 cm

Peigne EUROSTIL de coupe spécial professionnel
Pente EUROSTIL corte especial máquina profissional



MOD. 06802

REF.07364

NEW



25,5 cm



MOD. 06802/82

REF.07364/58

NEW

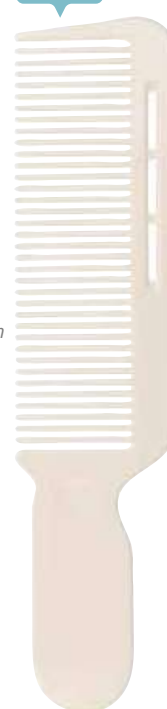

25,5 cm

Gran peigne professionnel à dents longues
Pente profissional escarpidor



REF.02183

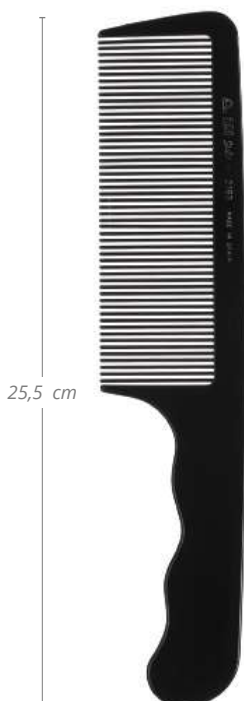

25,5 cm



20,5 cm



REF. 00453



REF. 00453/99



Peigne noir
Pente batidor preto

12
u.m./vta48
box

L

REF. 00136

P.V.P.R 0,60€

REF. 00136/50



22 cm



REF. 00136/97



REF. 00136/98



Boîte de 100 peignes scellés, jetables
Dispensador 100 pentes uma utilização pré-cintados



Peigne scellé pour assurer la garantie de non-utilisation.

REF.03053

» Couleurs classiques
 » Cores clássicas

REF.03053/98

peine selado para assegurar a garantia de não utilização em serviços anteriores.

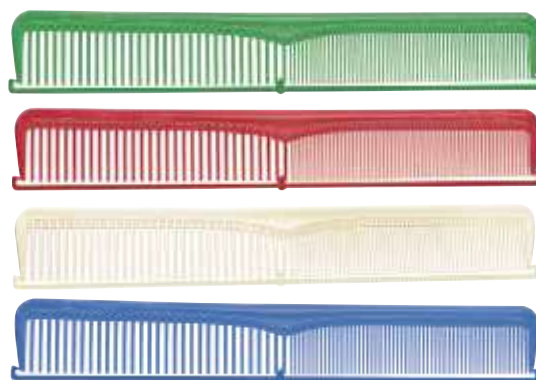

» Couleurs métalliques
 » Cores metálicas

REF.03053/97

» Couleurs d'été
 » Cores do verão

REF.03053/99

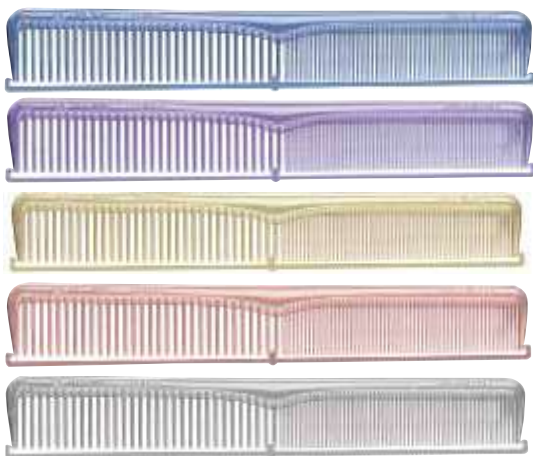

Peignes professionnels de couleurs Pentes profissionais cores sortidas

Les peignes professionnels sont disponibles maintenant dans des couleurs amusantes pour rendre votre salon plus coloré. Les références terminées en / 99 sont celles des peignes de couleurs: Vert, Bleu, Orange, Rose, Fuchsia et Lila. Sur la photo, vous pouvez voir la gamme chromatique.

Os pentes profissionais agora em cores divertidas para trazer mais colorido ao seu salão. As referências terminadas em /99 são as dos pentes de cores: Verde, Azul, Laranja, Rosa, Fúcsia e Lilás. Na fotografia pode-se apreciar a gama cromática.

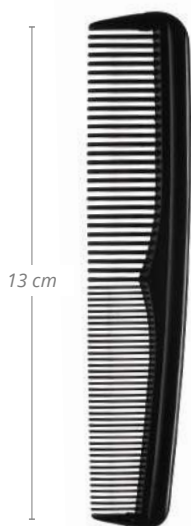

12
u.m.vta

60
box

REF. 00177/50

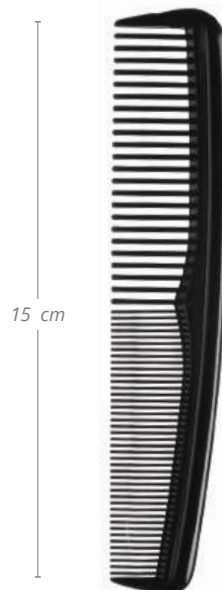

12
u.m.vta

60
box

REF. 00178/50

12
u.m.vta

120
box

REF. 00179/50



12
u.m.vta

60
box

REF. 00180/50

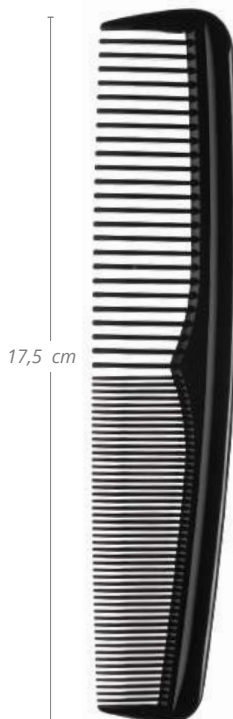

12
u.m.vta

72
box

REF. 00113

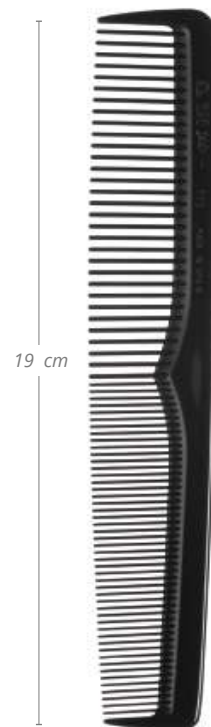

Peignes en CARBONE

Pentas CARBONO



» Peigne de coupe
» Batidor corte

12
u.m.vta

72
box

» Peigne de coupe
» Batidor corte

12
u.m.vta

72
box

» Peigne spécial à dents
» Batidor dente especial

12
u.m.vta

96
box

REF. 02186

REF. 02216

REF. 02214

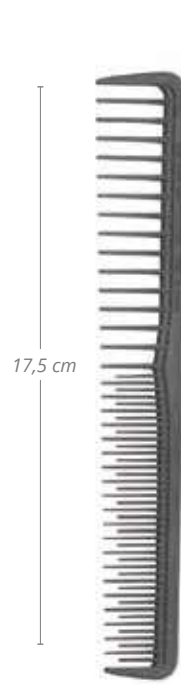

» Peigne spécial de
coiffure
» Especial cabeleireiro

12
u.m.vta

72
box

» Peigne spécial à
dents
» Dentição especial

12
u.m.vta

72
box

» Peigne modèle DROIT
» Batidor mod. RECTO

12
u.m.vta

48
box

REF. 02215

REF. 02187

REF. 02188

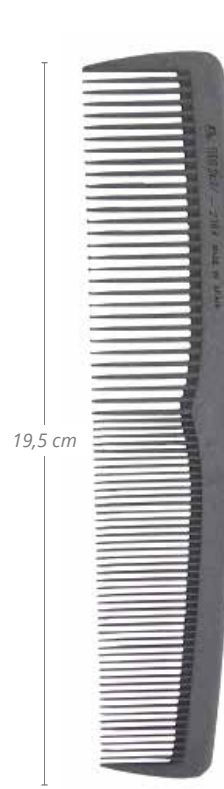

Peignes en CARBONE**Pentes CARBONO**

- » Peigne avec dent de séparation
- » Pente batidor com dentes de separação

12
u.m.vta

240
box

REF. 03408



- » Peigne avec dent de séparation
- » Pente batidor com dentes de separação

12
u.m.vta

240
box

REF. 03407



- » Peigne avec dent de séparation

- » Pente batidor
- » Dentes de separação

12
u.m.vta

192
box

REF. 03406

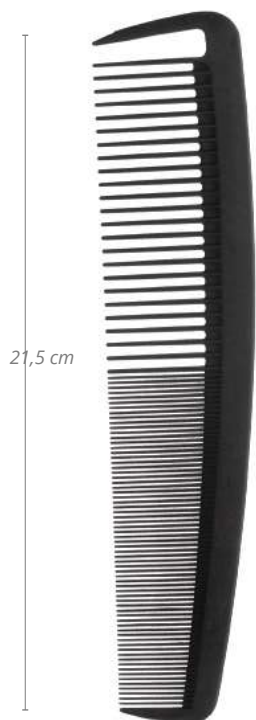

- » Peigne professionnel à dents en métal

- » Pente dentes
- » metal profissional

12
u.m.vta

240
box

REF. 03411



- » Peigne professionnel

- » Pente profissional

12
u.m.vta

240
box

REF. 03410



Peignes anonymes grande consommation
Pentes anônimos grande consumo

120
u.m.vta

120
box

» Peigne de peigne
 » Batedor de pente

REF.00458

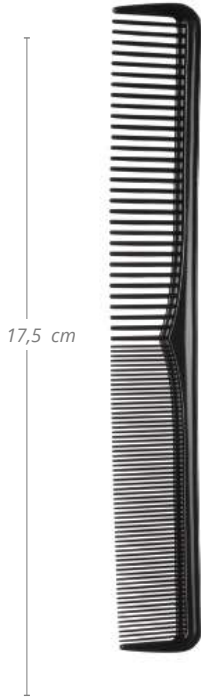

» Peigne barbelé en plastique
 » Pente plástico

REF.00459



» Peigne spécial avec 5 dents
 » Pente 5 dentes metal

REF.00461



» Peigne avec dents en fer
 » Pente dentes Ferro

REF.00460



Set de peignes professionnels de coiffeur, couleurs
Set pentes profissionais cabeleireiro, cores sortidas



» Comprend 9 peignes professionnels
 » Inclui 9 pentes profissionais

REF.03928/99

REF. 00453
 REF. 00454
 REF. 01469
 REF. 00423
 REF. 00441
 REF. 00115
 REF. 00116
 REF. 00118
 REF. 00422



Étui de peignes professionnels Estojo pentes profissionais

10
u.m.vta

10
box

» Comprend 6 peignes professionnels
» Inclui 6 pentes profissionais

REF.00950

» Comprend 4 peignes professionnels et une
brosse araignée

REF.00951

» Inclui 4 pentes profissionais e uma esqueteo

REF. 00114
REF. 00115
REF. 00116
REF. 00118
REF. 00128
REF. 00136/50

REF. 00114
REF. 00115
REF. 00136/50
REF. 00404/50
REF. 00550/50



Set professionnels pour coiffeurs, en nylon Set profissionais cabeleireiro, de nylon

» Comprend 9 peignes professionnels
» Inclui 9 pentes profissionais

6
u.m.vta

6
box

REF.03928

REF. 00114
REF. 00115
REF. 00116
REF. 00180/50
REF. 00404/50
REF. 00136/50
REF. 00118
REF. 01977
REF. 00962



Ensemble d'outils de coiffeur professionnel Conjunto de ferramentas de cabeleireiro profissional

» Comprend 9 outils professionnels
» Inclui 9 ferramentas profissionais

6
u.m.vta

6
box

REF.04347

REF. 00114
REF. 00115
REF. 00116
REF. 00180/50
REF. 00404/50
REF. 00136/50
REF. 00118
REF. 01977
REF. 00962



Peigne PEGASUS
Pente batidor PEGASUS



1
u.m.vta

10
box

- » Peignes en plastique
- » Faits à la main
- » Antistatiques

- » Pentes de plástico
- » Feitos à mão
- » Anti-estática

REF. 04242



REF. 04245



- » Peigne de coupe
- » Pente corte

REF. 04249



- » Peigne de coupe
- » Pente corte

REF. 04246

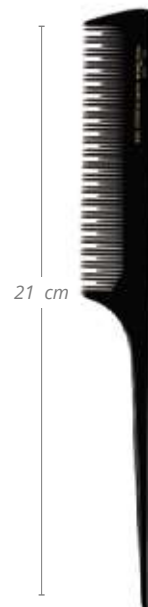

Boîte de 12 unités
Pentas profissionais POLLIÉ

Pollié

1 u.m.vta
40 box

» 5 dents
» 5 dentes

Pollié 334

» à 5 dents
» 5 dentes

Pollié 351

» 5 dents métal
» 5 dentes metal

Pollié 309

REF.01886

REF.01887

REF.01885



Boîte de 12 unités
Caixa 12 u. Pente dentes

1 u.m.vta
40 box

Pollié 307

REF.01884

1 u.m.vta
50 box

Pollié 308

REF.01883

» Dents fer
» Dentes ferro

1 u.m.vta
40 box

Pollié 310

REF.01882



Boîte de 12 unités

Caixa 12 u. Pente batidor

» Nylon
» Nylon1
u.m.vta 40
box

Pollié 310

REF.01876

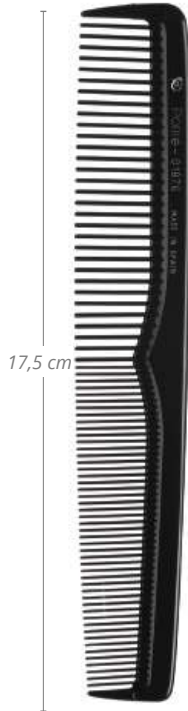
» Nylon
» Nylon1
u.m.vta 40
box

Pollié 338

REF.01877

» Nylon
» Nylon1
u.m.vta 40
box

Pollié 339

REF.01878

» Nylon
» Nylon1
u.m.vta 50
box

Pollié 306

REF.01879

» Nylon
» Nylon1
u.m.vta 40
box

Pollié 302

REF.01880

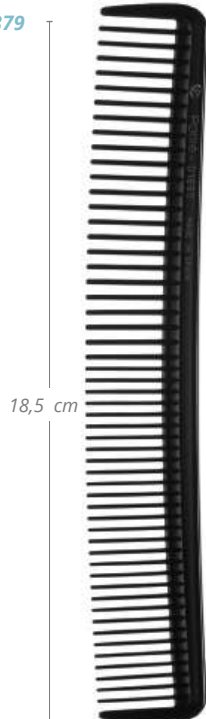
» Nylon
» Nylon1
u.m.vta 50
box

Pollié 305

REF.01881

» Nylon
» Nylon1
u.m.vta 50
box

Pollié 304

REF.01875

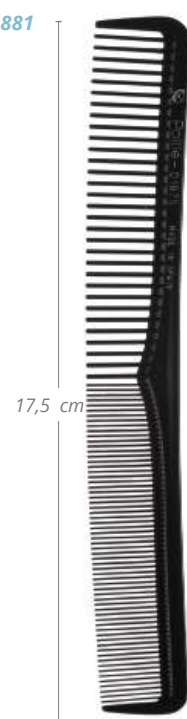

MATADOR
 PROFESSIONAL
1
u.m.vta12
box
Peignes MATADOR
Pentes "MATADOR"

 » Avec manche
 » Com punho

2607/9

REF. 02607

 » Avec manche P.A
 » Com punho P.A

2607/9G

REF. 01638



2206/9

REF. 02206



2246/8,5

REF. 02246



2246/7,5

REF. 01637



2255/7

REF. 02255

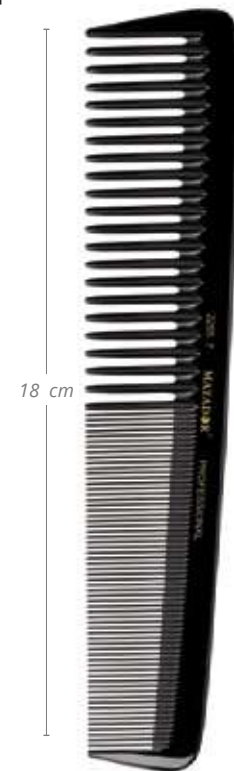

Peignes MATADOR
Pentas "MATADOR"

MATADOR
PROFESSIONAL



1
u.m.vta

12
box

» Spécial
» Especial

2660/7,25

REF. 02660

» Avec manche P.A
» Com punho P.A

2677/7

REF. 02331

» Avec manche P.A
» Com punho P.A

2211/7

REF. 02211

18,5 cm



18 cm



18 cm



» Largeur
» Largura

2689/6,5

REF. 02689

» Spécial
» Especial

2614/7T

REF. 01639

» Coupe
» Corte

2614/7

REF. 02614

» Coupe
» Corte

2605/7

REF. 02330

23 cm



17,5 cm



17,5 cm



18 cm



Peignes matador
Pentes "matador"

MATADOR
PROFESSIONAL



1
u.m.vta

12
box

» Dents 8,5P
» Dente 8,5P

391/8G

REF. 01654

» Dents 8
» Dente especial 8

391/8FT

REF. 01653

385/8,5G

REF. 01649

» Dents métal
» Dentes metal

386/8,5G

REF. 01652



Voulez-vous en savoir plus sur les origines de la marque MATADOR?
Quer saber mais acerca da origem da marca MATADOR?

Peigne professionnel SILKOMB
Pente profissional SILKOMB

SILKOMB



1
u.m.vta

12
box

PRO-10

REF. 01520

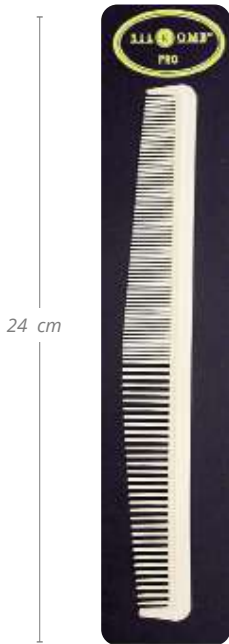

24 cm

PRO-11

REF. 01521



17,5 cm

PRO-20

REF. 01522



19 cm

PRO-30

REF. 01523



19 cm

PRO-40

REF. 01524



23 cm

PRO-50

REF. 01525



22,5 cm

Peigne démêlant de couleurs
Pente cores sortidas



M

REF. 00138



S

REF. 00400



L

REF. 00448

» Dents larges
 » Dentes largos



L

REF. 00412

» Dents courbées
 » Dentes curvos



S

REF. 00408



Peignes démêlant

Pentes

- » Dents courbes
- » Dentes curvos

12
u.m.vta48
box

REF. 00407

- » Avec manche en caoutchouc
- » Com punho de borracha

36
u.m.vta36
box

REF. 00425



Peigne droit

Pente batidor reto

12
u.m.vta300
box

S

REF. 00111

12
u.m.vta300
box

S

REF. 00111/50

12
u.m.vta48
box

L

REF. 00444

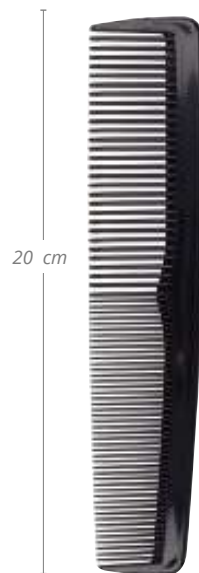

Peignes

Pentes batidor



» Double dent
» Dupla fileira de dentes

12
u.m.vta

48
box

REF. 00435

» Pour les mèches
» Madeixas

12
u.m.vta

60
box

REF. 00427



» Mèches
» Madeixas

12
u.m.vta

60
box

REF. 00471

» Cheveux ondulés
» Cabelo ondulado

12
u.m.vta

60
box

REF. 00420

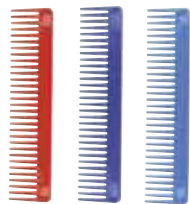

Peigne creux de couleurs
Pente dentes largos cores diferentes



S

REF. 00419



Transparent
 Transparente
 REF. 00419/56



L

REF. 00426

Peigne échelon pour les mèches
Pente escala madeixas



REF.00421



Pot de 60 peignes à crêper, couleurs assorties
Set de 60 pentes de cores sortidas, metálicos

2 u.m.vta 2 box

» Dents en plastique
 » Dentes de plástico

MOD. 00423

» Couleurs métalliques
 » Cores metálicas

MOD. 00423

REF.03251

REF.03251/97



Pot de 60 peignes couleurs assorties
Set de 60 pentes de cores sortidas

» Dents en plastique
 » Dentes de plástico

2 u.m.vta 2 box

MOD. 00115

REF.03845

» Couleurs métalliques
 » Cores metálicas

2 u.m.vta 2 box

MOD. 00115

REF.03845/97



Pot 60 peignes coupe
Set 60 pentes corte

- » Dents en plastique
- » Dentes de plástico

MOD. 00116/99

REF.03250

2
u.m.vta

2
box

MOD. 00422

REF.03847



Pot de 60 peignes couleurs
Set de 60 pentes de cores sortidas

- » Dents en plastique
- » Dentes de plástico

2
u.m.vta

2
box

MOD. 00441

REF.03848

Pot de 30 peignes à crêper double hauteur
Set de 30 escovas de dupla altura

- » Dents en plastique
- » Deux hauteurs

1
u.m.vta

20
box

- » Dentes de plástico
- » Double pin

MOD. 00115

REF.04350



Pot 60 peignes couleurs assorties Set 60 pentes cores sortidas

- » 5 dents métalliques
- » 5 dentes de metal



MOD. 00128

REF.03853



Pot 24 peignes s à crêper Set 24 pentes

- » Dents métalliques
- » Dentes de metal



MOD. 01469/99

REF.03852



Pot de 30 brosses à crêper Set de 30 escovas

- » Dents en plastique
- » Couleurs translucides

- » Dentes de plástico
- » Cores translúcidas



MOD. 03880

REF.04222



Pot de 60 peignes couleurs Set de 60 pentes de cores sortidas

- » Dents métalliques
- » Dentes de metal



MOD. 00118

REF.03850



Boîte de 30 peignes translucides. Couleurs assorties
Set 30 pentes translúcidos cores sortidas

- » Boîte en plastique transparente
- » Caixa de plástico transparente



MOD. 00136

REF.01854



22 cm

Boîte de 60 peignes translucides, modèle 116. Couleurs assorties
Set de 60 pentes transparentes mod.116, Cores sortidas



MOD. 00116

REF.01621



19,5 cm

Boîte de 60 peignes translucides, modèle. 423. Couleurs assorties. Idéal pour crêper
Set de 60 pentes transparentes mod 423, cores sortidas, ideal para crepar



MOD. 00423

REF.01625

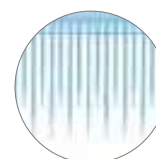

20,5 cm

Brosse de massage en silicone
Escova massagem silicone

- » Dents en silicone
- » Dentes de silicone



REF.04427



Boîte de 12 brosse de massage de couleurs
Set de 12 escovas massagem cores sortidas

- » Dents en plastique
- » Dentes de plástico



REF.04403



Boîte de 24 mini brosse pneumatiques
Set de 24 escovas pneumáticas mini

- » Poils en plastique arrondis
- » Cerdas de plástico com bola



REF.02471



Boîte de 24 mini brosse pliables
Set de 24 escovas dobráveis mini

- » Poils en plastique arrondis
- » Avec miroir



REF.02789



Petit peigne démêlant couleur bois
Pente escarpidor cor madeira



» À dents courbes
 » Dentes curvos

REF. 00408/55

» À dents courbes
 » Dentes curvos

REF. 00407/55

REF. 00136/55



Peigne pour mèches
Pente madeixas



REF. 00409/99

REF. 00409

REF. 00409/50



Peignes de couleurs en bois

Pentes cor madeira



- » Peigne
- » Pour mèches

REF. 00410

- » Peigne afro à 5 dents

REF. 00404

- » Peigne à dents 5 pointes courbes

REF. 00127

- » Pente batidor
- » Madeixas

- » Pente 5 dentes
- » largos

- » Pente dentes largos
- » 5 pontas curvas



Peigne démêlant en bois

Pente escarpidor madeira



- » À dents en bois
- » Dentes de madeira

REF. 04240



REF. 04241

Peigne afro
Pente dentes largos

- » Double dent
- » Dupla fileira



REF. 00450

**Peigne afro professionnel**
Pente profissional

- » Double dent
- » Dupla fileira



REF. 01852

**Grand peigne afro**
Pente dentes largos

- » Double dent
- » Dupla fileira



REF. 00414



- » Double dent
- » Petit



REF. 00417

- » Dupla fileira,
- » Pequeno



Avec le peigne creux, vous pouvez créper vos cheveux leur donner du volume, un effet froissé sans perdre le style ni l'élégance.

Poderá criar um cardado espesso, abundante, desordenado, mas com estilo.

Peigne démêlant professionnel

Pente dentes largos

- » Dents creuses
- » Double dents noir

- » Dentes largos
- » Dupla fileira, gigante preto



19,5 cm



REF. 00451



- » Dents creuses
- » Double dents et de couleurs

- » Dentes largos
- » Dupla fileira, gigante cores



19,5 cm



REF. 00434

Peigne afro noir

Pente dentes largos preto

- » Pliable
- » Dobrável



REF. 00432

- » 11 dents. Moyen
- » 11 dentes. Médio



REF. 00402/50

- » 11 dents. Grand
- » 11 dentes. Grande



REF. 00403/50



19 cm



16,5 cm



17,2 cm

Peigne afro couleur bois

Pente dentes largos cor madeira

- » 11 dents. Mini
- » 11 dentes. Mini

REF. 00406

- » 11 dents. Moyen
- » 11 dentes. Médio

REF. 00402

- » 11 dents. Grand
- » 11 dentes. Grande

REF. 00403



11 cm



16,5 cm



17,2 cm

Peigne écaille
Pente batidor



REF. 04236



Peigne écaille
Pente batidor concha



REF. 04238



REF. 04237



REF. 04239



Peignes écaille pour coiffeur
Pente batidor concha calelereiro

REF. 04230

REF. 04231

REF. 04232

REF. 04229

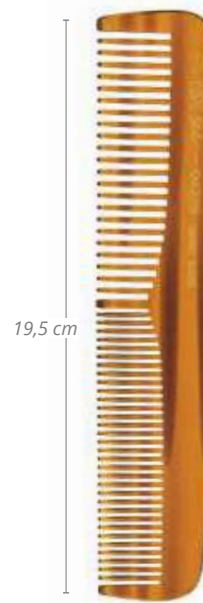
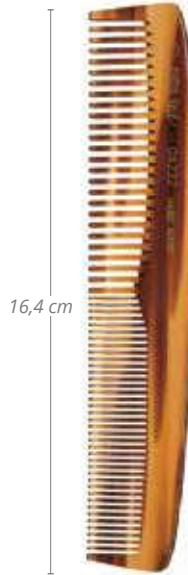
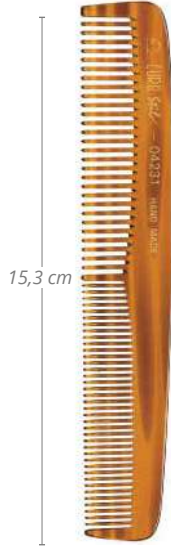
**Peigne écaille**
Pente batidor concha reforçao

REF. 04233

REF. 04234

» Fer à repasser
» Picareta de ferro

REF. 04235

» Peigne écaille
» Pente concha

REF. 04262

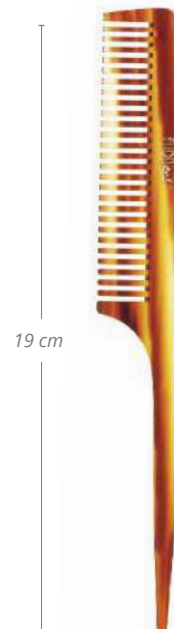



Peigne écaille Pente concha

» Peigne
» Pente batidor



REF. 00177

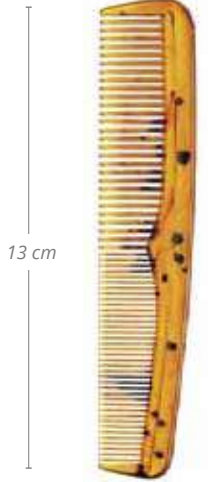

» Peigne
» Pente batidor



REF. 00178

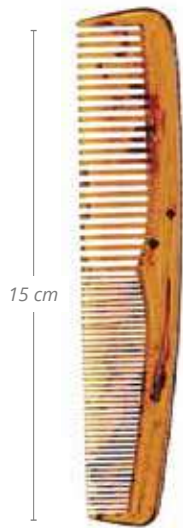

» Peigne
» Pente batidor



REF. 00179

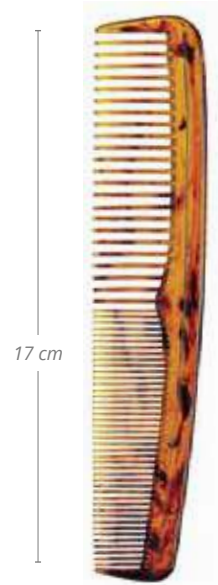

» Peigne
» Pente batidor



REF. 00180

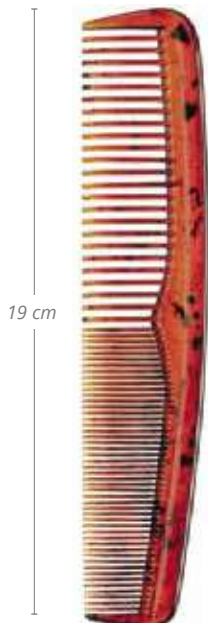

REF. 00444/51



» Peigne démantelant
» Pente escarpidor



REF. 00136/51



**RESPECTUEUX DE L'ENVIRONNEMENT
 LIGNE DE PRODUITS EN MATÉRIAUX RECYCLÉS
 (FABRICATION PROPRE)**

Étude durabilité produits réalisée par l'entreprise LEITAT l'objectif principal est de créer une ligne plus durable de produits.

Concrètement, le bol réf. 00655 réduit son impact environnemental global de 26%, le pinceau réf. 00102 de 28%, le peigne réf. 00136 de 28% et le peigne réf. 00409 de 21% avec l'utilisation de polypropylène recyclé.

Utiliser du polypropylène recyclé permet de réduire les impacts environnementaux de 25 à 28%. Les impacts liés à l'obtention de matières premières représentent de 17 à 37% des impacts produits par les produits fabriqués avec du polypropylène vierge.



**COMPROMETIDO COM O MEIO AMBIENTE
 LINHA DE PRODUTOS DE MATERIAIS RECICLADOS
 (PRÓPRIA FABRICAÇÃO)**

Estudo de sustentabilidade do produto realizado pela empresa LEITAT como objetivo principal é criar uma linha de produtos mais sustentável.

Especificamente, a tigela ref. 00655 reduz seu impacto ambiental global em 26%, a paleta ref. 00102 28%, o pente ref. 00136 28% e o pente ref. 00409 21% com o uso de polipropileno reciclado.

O uso de polipropileno reciclado reduz os impactos ambientais entre 25 e 28%. Os impactos devido à obtenção de matérias-primas representam entre 17 a 37% dos impactos em produtos feitos de polipropileno virgem.

Peigne batteur en acétate renforcé
Pente batedor de acetato reforçado

REF.00136/222



NEW



REF.00409/222



NEW

**Grande palette de matériaux recyclés**
Paleta grande de material reciclado

REF.00102/222



NEW

**Grand bol en plastique recyclé**
Tigela grande de plástico reciclado

REF.00655/222



NEW



Bigoudis, crêpons à chignon et bonnets

ROLOS, BIGUDIS
E GORROS

*Rouleaux, bigoudis, piques à cheveux,
papillotes, bonnet cheveux, bonnets...*

*Rolos, bigudis, alfinetes,
papelotes, redes, gorros...*



Sachet de 12 bigudis en bois cannelé
Bolsa 12 bigudis madeira estriada



N° 0

REF.01544



N° 3

REF.01546



N° 5

REF.01548



N° 8

REF.01571



Sachet de 6 bigudis en bois cannelé
Bolsa 6 bigudis madeira estriada



N° 10

REF.01573



N° 12

REF.01550



Sachet de 10 bigudis en bois cannelé
Bolsa 10 bigudis madeira estriada

REF.01559

1 u.m.vta
160 box

Ø 6



REF.01560

1 u.m.vta
120 box

Ø 8



REF.01561

1 u.m.vta
90 box

Ø 10



REF.01562

1 u.m.vta
60 box

Ø 12



Douzaine de bigudis
Dúzia de bigudis ondulado

12 u.m.vta
12 box

» Ondulés
 » En plastique, bicolor

» Ondulado
 » Plástico bicolor

REF.01500

Ø 7,5

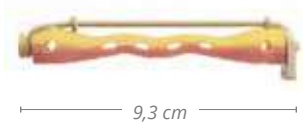

REF.01501

Ø 8,5

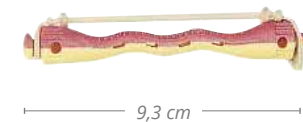

REF.01502

Ø 10

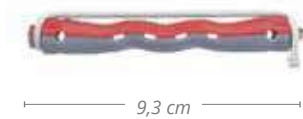

REF.01503

Ø 12



REF.01504

Ø 16

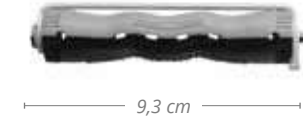

Sachet de 100 bigudis
Bolsa 100 bigudis

» En plastique
 » Plástico

1 u.m.vta
36 box

REF.01554

N° 1

Ø 7,8



REF.01555

N° 2

Ø 8,9



REF.01556

N° 3

Ø 10



REF.01557

N° 4

Ø 12



REF.01558

N° 5

Ø 14



Douzaine de bigoudis en plastique cannelé

Dúzia bigudis plástico estriado

1
u.m.vta

24
box



5,9 cm

REF.01239

» Inclus un sachet avec des piques à cheveux
» Inclui um saco com alfinetes



5,9 cm

REF.01241



5,9 cm

REF.01242



5,9 cm

REF.01243



Sachet de 50 bandes élastiques pour bigoudis

Bolsa 50 elásticos para bigudis

» Plats
» Longs

» Plano
» Largas

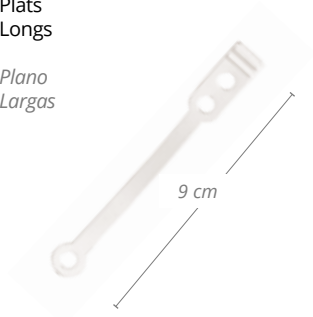

12
u.m.vta

12
box

REF.00864

» Ronds
» Longs

» Redondas
» Largas



12
u.m.vta

12
box

REF.00862

» En silicone
» Court

» Silicone
» Curto

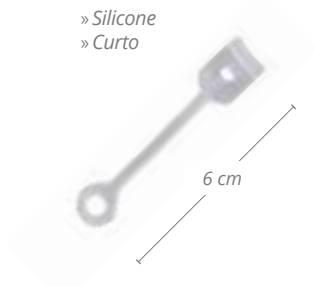

1
u.m.vta

50
box

REF.01490

» Plats
» Courts

» Plano
» Curto

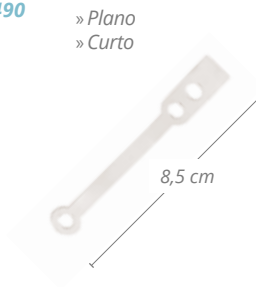

12
u.m.vta

12
box

REF.00865

» Ronds
» Court

» Redondas
» Curto

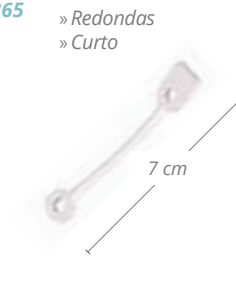

12
u.m.vta

12
box

REF.00863

Anneaux bigoudis 100 gr
Curler bigudis 100 gr

REF.00653

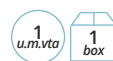
Pour les bigoudis en bois
Para bigudis madeira**Sachet de 50 élastiques de rechange**
Bolsa 50 elásticos troca

REF.00867

Pour les bigoudis en bois
Para bigudis madeira**Douzaine de bigoudis**
Dúzia bigudis plástico

REF.00900

- » Longue
- » En plastique
- » Bicolores

- » Longos
- » Plástico
- » Bicolor

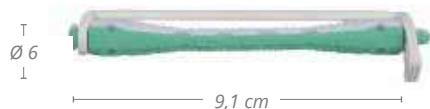

REF.00901



REF.00902



REF.00903



REF.00904



REF.00905

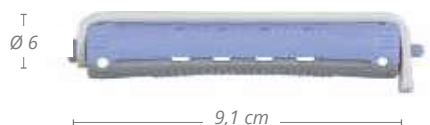

REF.00906

**Douzaine de bigoudis**
Dúzia bigudis plástico

REF.00907

- » Courts
- » En plastique
- » Bicolores

- » Curtos
- » Plástico
- » Bicolor



REF.00908



REF.00909



REF.00910



REF.00911

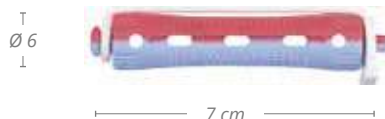

REF.00912



REF.00913



Papillotes longues et courtes (12 unités)
Papelotes largas e curtos 12 unidades



Longue
Largo

Court
Curtos

REF. 01244

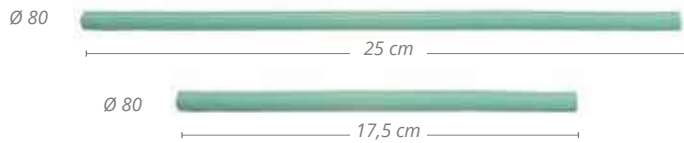

REF. 01251

REF. 01245



REF. 01252

REF. 01246

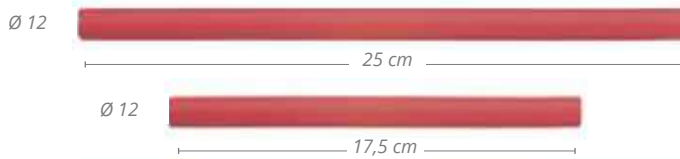

REF. 01253

REF. 01247

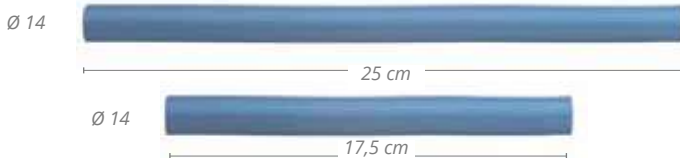

REF. 01254

REF. 01248

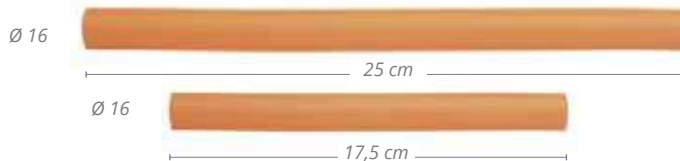

REF. 01255

REF. 01249

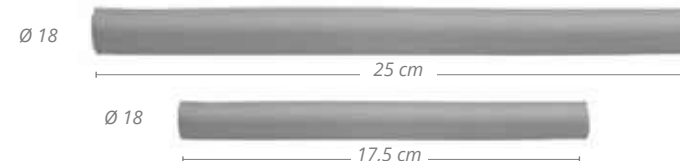

REF. 01256

REF. 01250



REF. 01257

Sachet 6 rouleaux maille
Bolsa 6 rolos de malha



» Bleu
 » Azul



Ø 10

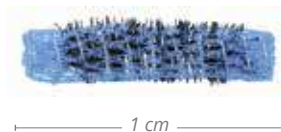

NEW

1 cm

1 u.m.vta 12 box

6 u

REF. 07333

» Rose
 » Rosa



Ø 13

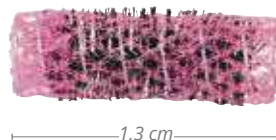

NEW

1,3 cm

1 u.m.vta 12 box

6 u

REF. 07334

» Lilas
 » Lilás



Ø 17



NEW

1,7 cm

1 u.m.vta 12 box

6 u

REF. 07335

» Rose
 » Rosa



Ø 22

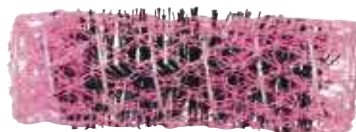

NEW

2,2 cm

1 u.m.vta 12 box

6 u

REF. 07336

Sachet 6 rouleaux maille noir
Bolsa 6 rolos de malha preta



NEW

Ø 28



2,8 cm

1
u.m.vta12
box

6 u

REF. 07337



NEW

Ø 32



3,2 cm

1
u.m.vta12
box

6 u

REF. 07338



NEW

Ø 36



3,6 cm

1
u.m.vta12
box

6 u

REF. 07339



NEW

Ø 45



4,5 cm

1
u.m.vta12
box

6 u

REF. 07340

Sachet de bigoudis adhésifs

Bolsa rolos aderentes



» Verts
» Verdes

1 u.m.vta
80 box
9 u

REF. 00015

Ø 23

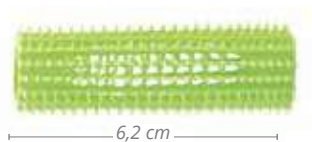

» Orange
» Laranjas

1 u.m.vta
70 box
8 u

REF. 00016

Ø 27

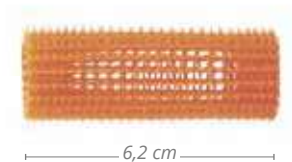

» Jaunes
» Amarelos

1 u.m.vta
45 box
8 u

REF. 00017

Ø 31



» Rouges
» Vermelhos

1 u.m.vta
40 box
6 u

REF. 00018

Ø 39

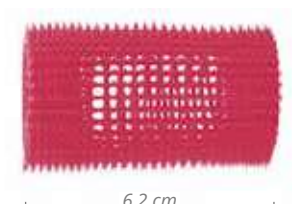

» Bleue
» Azuis

1 u.m.vta
25 box
5 u

REF. 00047

Ø 45

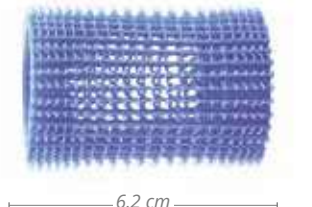

» Violet
» Lilás

1 u.m.vta
20 box
5 u

REF. 00024

Ø 55

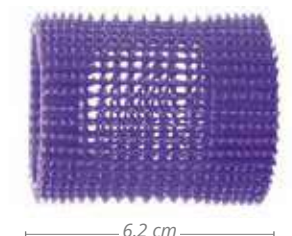

Kit pour boucler les cheveux 60 boucles

Kit encaracolador cabelo 60 caracóis

» Roses
» Rosa

1 u.m.vta
16 box
4 u

REF. 00025

Ø 65

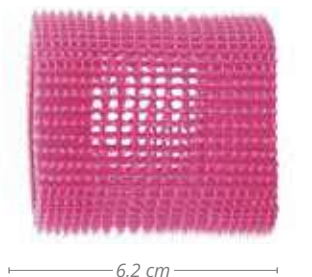

» 12 boucles pour 5 mesures
» 12 caracóis para 5 medições

1 u.m.vta
12 box
60 u

REF. 04428



Sachet de bigudis chauffants

Bolsa rolos quentes

Attention, ne pas utiliser dans le microondes
Atenção, não use na microondas



» Petits
» Pequenos

6 u

REF. 00019

» Moyenne
» Médios

6 u

REF. 04024

» Grands
» Grandes

5 u

REF. 00020

Ø 17



6,5 cm

Ø 20



6,5 cm

Ø 24



6,5 cm

Sachet de bigudis chauffants

Bolsa rolos quentes

Attention, ne pas utiliser dans le microondes
Atenção, não use na microondas



» Petits
» Pequenos

6 u

REF. 03391

» Moyenne
» Médios

6 u

REF. 03392

Ø 17



6,5 cm

Ø 23



6,5 cm

» Grands
» Grandes

5 u

REF. 03393

» Grands
» Grandes

4 u

REF. 03394

Ø 28



6,5 cm

Ø 32



6,5 cm

Sachet de 12 bigudis en mousse

Bolsa 12 rolos espuma



» Bleue
» Azuis

REF. 04019

Sachet de 12 bigudis en mousse

Bolsa 12 rolos espuma



» Verts
» Verdes

REF. 04021

Ø 15



6 cm

Ø 25



6 cm

» Jaunes
» Amarelos

REF. 04020

» Roses
» Rosa

REF. 04023

Ø 20



6 cm

Ø 35



6 cm

Boucle de cheveux rose translucide

Rolos rosa translúcido



12
u.m.vta

120
box

Nº0

REF. 00000



12
u.m.vta

72
box

Nº1

REF. 00001



12
u.m.vta

240
box

Nº2

REF. 00002



12
u.m.vta

144
box

Nº3

REF. 00003



12
u.m.vta

120
box

Nº4

REF. 00004



12
u.m.vta

72
box

Nº5

REF. 00005



12
u.m.vta

60
box

Nº6

REF. 00006



12
u.m.vta

48
box

Nº7

REF. 00007



12
u.m.vta

24
box

Nº8

REF. 00008



Les bigodis roses fabriqués dans les Industries d'Oriol sont un classique très valorisé pendant toute l'histoire de la société.

Os rolos rosa fabricados nas Indústrias Oriol são um clássico muito valorizado ao longo dos anos de história da empresa.

Sachet de 12 bigoudis super fort (comprend un sachet avec piques à cheveux)
Bolsa 12 rolos extra super forte (inclui saco com ganchos)

1
u.m.vta

12
box

- » Cheveux spéciaux afro et résistants
- » Especial cabelo afro e cabelo resistente



REF. 04665



REF. 04666

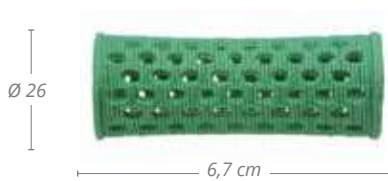

REF. 04667

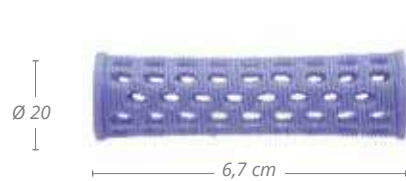

REF. 04668



REF. 04669



REF. 04670



Sachet de 6 bigoudis super-adhésifs
Bolsa 6 rolos super aderentes

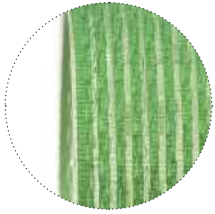

Ø 13



6 cm

REF.00009

Ø 15



6 cm

REF.00031

Ø 21



6 cm

REF.00010

Ø 24



6 cm

REF.00011

Ø 28



6 cm

REF.00012

Ø 32



6 cm

REF.00013

Ø 36



6 cm

REF.00014

Sachet de 3 bigoudis super-adhésifs
Bolsa 3 rolos super aderentes

Ø 40



6 cm

REF.00028

Ø 44



6 cm

REF.00032

Ø 48



6 cm

REF.00033

Ø 60



6 cm

REF.00034

Bigoudis · Rolos

Sachet de 12 bigoudis super-adhésifs (les couleurs peuvent varier)
Bolsa 12 rolos super aderentes (as cores podem variar)



Ø 34



6,2 cm

1
u.m.vta16
box

REF. 04003

Ø 34



6,2 cm

1
u.m.vta12
box

REF. 04006

Sachet de 6 bigoudis super-adhésifs
Bolsa 6 rolos super aderentes

Ø 38



6,2 cm

1
u.m.vta6
box

REF. 04007

Sachet de Piques à cheveux
Bolsa de ganchos chave

» Métallique
 » Long

» Metálico
 » Longo

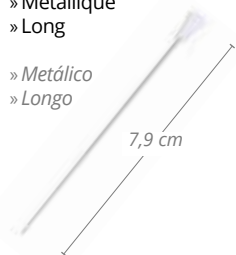

7,9 cm

1
u.m.vta50
box

100 u

REF.01495

» Nylon
 » Nylon

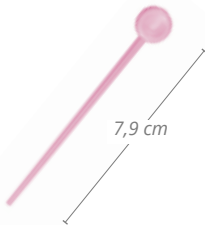

7,9 cm

12
u.m.vta192
box

36 u

REF. 00649

» Nylon
 » Nylon

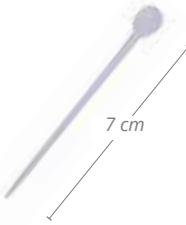

7 cm

12
u.m.vta192
box

36 u

REF. 00648

Boîte de Piques à cheveux
Box de ganchos chave

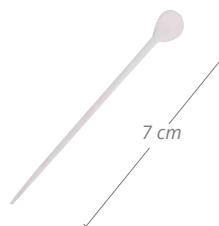

7 cm

1
u.m.vta16
box

300 u

REF. 03329

Bonnet de nuit sans bande
Rede noite sem cinta

12
u.m.vta

12
box

» Noir
 » Preto

REF.01049/50

» Brun foncé
 » Castanho escuro

REF.01049/67



» Brun naturel
 » Castanho natural

REF.01049/76

» Châtain clair
 » Castanho claro

REF.01049/65



» Rose
 » Rosa

REF.01049/70

» Bleu
 » Azul

REF.01049/59



Filet élastique triangulaire Rede secador triangular

12
u.m.vta12
box

- » Pour mise en plis
- » Elástica

90 x 72 x 72 cm

- » Ajouré, avec bordure
- » Com acolchoamento

80 x 70 x 70 cm



REF.01044/50

REF.01044/59



REF.01042/59

REF.01042/68

REF.01044/69

REF.01044/70

REF.01042/69

- » Sans bordure
- » Sem acolchoamento

83 x 74 x 74 cm

- » Avec bordure
- » Com acolchoamento

83 x 74 x 74 cm



REF.01039/50

REF.01039/59



REF.01041/50

REF.01041/59

REF.01039/69

REF.01039/70

REF.01041/69

REF.01041/70

Bonnet de nuit Rede noite

12
u.m.vta12
box

- » Avec bande
- » Com cinta

REF.01048/50

REF.01048/59

- » Nylon
- » Assortiment de couleurs

REF.01053

- » Nylon noite,
- » Cores surtidas



REF.01048/69

REF.01048/70



Bonnet de nuit
Touca noite12
u.m.vta 60
box» Nylon
» Nylon

REF.01539

» Nylon avec bande
» Nylon noite com cinta

REF.01538

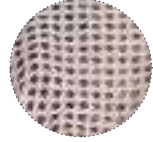
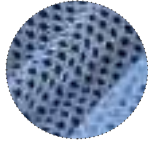
**Bonnet de douche**
Touca duche» Imprimé
» Estampado12
u.m.vta 60
box

REF.01542

» Permanente
» Plastique 3 pièces12
u.m.vta 12
box

REF.00967

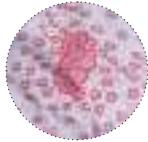
» Plástico
» Permanente 3 peças

REF.01227

REF.01227/58

» À usage unique
» Utilização única200
u.m.vta 200
box

REF.01540



Sachet de bonnets à mèches Touca madeixas



- » Double couche
- » Dupla capa

5 u

REF. 01290



- » bordures noires
- » Borda cor preto



10 u

REF.02532/50



- » Avec crochet
- » Com gancho

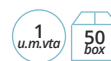

50 u

REF.00973

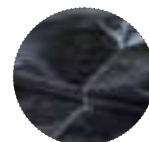

Bonnets à mèches Touca madeixas

- » Plastique (adapté pour tirer les mèches). Sans trous.

- » Plástico madeixas tiras.
- » Sem furos.



REF.00965



- » Caoutchouc
- » Marron

- » Borracha
- » Castanho



REF. 00896



Bonnets à mèches

Touca madeixas

- » Translucide avec crochet
- » *Translúcido, com agulha*



REF. 02196

- » Translucide avec crochet
- » *Translúcido, com agulha*



REF. 03402



- » Silicone perforé
- » Grand

- » *Silicone perfurado*
- » *Grande*



REF.06460



- » Spécial en silicone
- » *Especial em silicone*



REF. 03729

- » Silicone
- » *Silicone*



REF. 00897



Bonnets à mèches
Touca madeixas



» Spécial en caoutchouc
 » Especial em borracha

REF. 00894

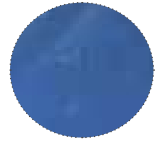

» Caoutchouc
 » Borracha

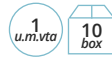

REF. 01511

» Spécial en caoutchouc
 » Especial em borracha



REF. 01995



Sachet de crochets bolsa agulhas



» Moyens
» Médias



6 u

REF. 01266

» 3 mesures
» 3 medidas

3 u

REF. 01265



Peigne spécial coiffure Pente especial cabeleireiro



REF. 00440



Sachet de crochets Bolsa agulhas



REF. 01966

» Doubles
» Duplas



Peigne à dents en métal crochet des mèches Pente metal gancho madeixas



REF. 00473



Les mèches au bonnet sont une alternative pour donner de la lumière aux cheveux, que ce soit en le décolorant ou avec la teinture.

As madeixas com gorro são uma alternativa para dar luz ao cabelo seja descolorando-o ou com tinta.

Bonnets**Gorros**

- » Aluminium
- » Alumínio

10
u.m.vta 10
box

REF.02534

- » Thermique pour sèche-cheveux
- » Térmico para secador

6
u.m.vta 6
box

REF.03189



- » Plastique "MACRO"
- » Plástico "MACRO"

12
u.m.vta 12
box

REF.00966

Serviette bonnet pour cheveux
Gorro toalha

- » Avec caoutchouc et doté d'un bouton
- » 100% coton

REF. 03404

- » Sans caoutchouc et sans bouton
- » Sem borracha e botão

1
u.m.vta 10
box

REF. 04433

- » Com borracha e botão
- » 100% algodão

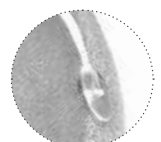
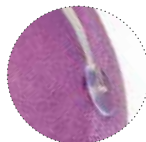

Bonnet cheveux invisibles
Redes invisíveis

 » Nylon
 » Nylon

 » Nylon
 » Nylon

 » Naturels
 » Cabelo natural

REF.01046/50



REF.01047/50



REF.01045/50



REF.01046/65



REF.01047/65



REF.01045/69



REF.01046/66



REF.01047/66



REF.01045/66



REF.01046/67



REF.01047/69



REF.01046/76



Crêpon à chignon rond
Apanhador para o puxo



9 gr

Petit · Pequeno

●
 REF. 03001/50

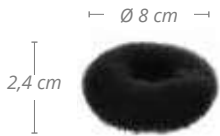

●
 REF. 03001/67

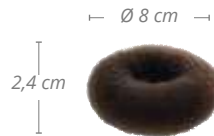

●
 REF. 03001/65

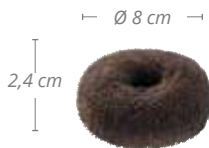

●
 REF. 03001/66



Moyen · Médio

●
 REF.04435/50

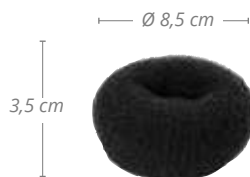

●
 REF.04435/65



●
 REF.04435/66



Crêpon à chignon rond
Apanhador para o puxo



14 gr

Moyen/grand
Médio/grande

REF.01453/50

REF.01453/65

REF.01453/66

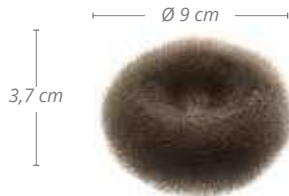
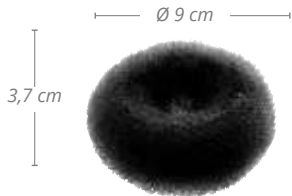

Grand · Grande

REF.04436/50

REF.04436/65

REF.04436/66

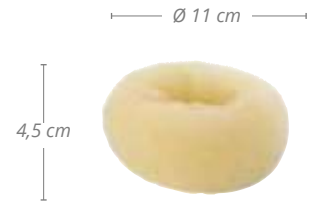
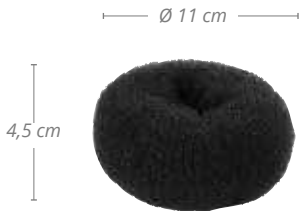

Extra grand
Extra grande

REF.04437/50

REF.04437/65

REF.04437/66

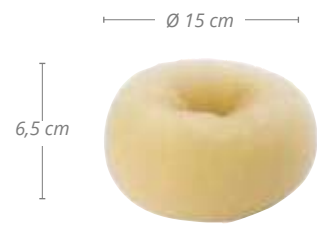

Crêpon à chignon Apanhador para o puxo



14 gr

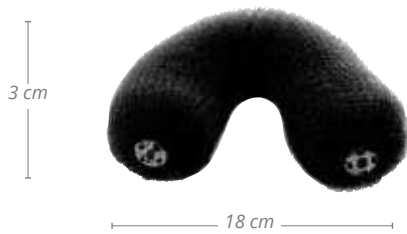

REF.01454/50



REF.01454/65



REF.01454/66

14 gr



REF. 03002/50



REF. 03002/67



REF. 03002/65



REF. 03002/66

Crêpon à chignon avec élastique Apanhador para o puxo com elástico



14 gr

REF.04434/50

REF.04434/65

REF.04434/66



Crêpon à chignon long de grande taille
Apanhador para o puxo, alargado



52 gr

REF. 03636/50

REF. 03636/65

REF. 03636/66



Crêpon à chignon rond de grande taille
Enchimento apanhador para o puxo, redondo



20 gr

REF. 03635/50

REF. 03635/65

REF. 03635/66



Comment utiliser?**Como usar?**

1. Faire une queue de cheval

1. Faça uma coleta



2. Passez la queue de cheval dans la bague et la fixer avec des épingles à cheveux

2. Faça um puxo, passe-o pelo aro e segure com ganchos



3. Appliquez un peu de laque et enroulez les cheveux autour de la bague

3. Aplique um pouco de laca e enrolo o cabelo em redor do aro.



1. Placez le crépon au sommet de la tête

1. Coloque o apanhador para o puxo na cabeça



2. Fixez le crépon

2. Posicione o apanhador para o puxo



3. Recouvrez le crépon avec les cheveux sur le front et le fixer avec des épingles à cheveux

3. Cubra o apanhador com os cabelos da parte da frente e segure-o com ganchos

10

Ciseaux

TESOURAS

Ciseaux, étuis...
Tesouras, estojos...



Ciseaux professionnel EXCELSIOR
Tesoura professional EXCELSIOR

1 u.m.vta 10 box

5,5"

REF.04900



» Coupe
 » Corte

» Matériel: Acier japonais V610
 » Dureté: 63HRC
 » Bord: Convexe

» Material: Aço japonês V610
 » Dureza: 63HRC
 » Rebordo: Convexo



Ciseaux INFINITY
Tesoura INFINITY

» Matériau : Acier 440 C
 » Dureté: 59-61 HRC

» Material: aço 440 C
 » Dureza: 59-61 HRC

1 u.m.vta 10 box



» Inclus: huile, suède, anneaux en caoutchouc et clé de serrage

» Incluir: óleo, camurça, anéis de borracha e chave de aperto

» Coupe
 » Corte

5,5"

REF.06976



» Coupe
 » Corte

6"

REF.06977



» Sculpteur
 » Esculpir

6"

REF.06978





» Inclus: huile, suède, anneaux en caoutchouc ou clé de serrage

» Inclui: óleo, camurça, anéis de borracha ou chave de aperto

Ciseaux AMATIST Tesoura AMATIST

» Matériau : Acier 440 C
» Dureté 59-61 HRC

» Material: aço 440 C
» Dureza: 59-61 HRC

1 u.m.vta
10 box

» Coupe
» Corte

5,5"

REF.06970



» Coupe
» Corte

6"

REF.06971



» Sculpteur
» Esculpir

6"

REF.06972



Ciseaux OASIS Tesoura OASIS

» Matériau : Acier 440 C
» Dureté 59-61 HRC

» Material: aço 440 C
» Dureza: 59-61 HRC

1 u.m.vta
10 box

» Coupe
» Corte

5,5"

REF.06973



» Coupe
» Corte

6"

REF.06974



» Sculpteur
» Esculpir

6"

REF.06975





- » Acier 440
- » Rasoir affûté
- » Finition manuelle
- » Grande dureté 59,61 HRC
- » Vis de réglage
- » Coffret individuel

- » Aço 440
- » Corte navalha
- » Acabamento manual
- » Grande dureza 59.61 HRC
- » Parafusos de ajuste
- » Estojo individual

EURO *styl*
PROFESSIONAL

Ciseaux SHARK Tesoura SHARK

- » Coupe
- » Corte

5,5"

REF. 04627

- » Sculpteur
- » Esculpir

5,5"

REF. 04628



Ciseaux PIRATA Tesoura PIRATA

- » Coupe
- » Corte

5,5"

REF. 04630

Ciseaux DARK Tesoura DARK

- » Coupe
- » Corte

5,5"

REF. 04629



Étui présentoir ciseaux Estojo mostruário porta-tesouras

- » 6 unités
- » 6 unidades



REF. 04633



Ciseaux ATENEA
Tesoura ATENEA

- Matériau : Acier martensitique 420J2
- Dureté : 56HRC

- » Material: aço 420J2
- » Dureza: 56HRC



» Non inclus: huile, suède, anneaux en caoutchouc ou clé de serrage

» Não inclui: óleo, camurça, anéis de borracha ou chave de aperto



» Coupe
» Corte

5,75"

REF.07020/68



» Sculpteur
» Esculpir

5,75"

REF.07021/68



» Coupe
» Corte

5,75"

REF.07020



» Sculpteur
» Esculpir

5,75"

REF.07021



» Coupe
» Corte

5,75"

REF.07020/70



» Sculpteur
» Esculpir

5,75"

REF.07021/70

**Ciseaux AFRODITA**
Tesoura AFRODITA

- Matériau : Acier 440C
- Dureté : 59-61 HRC

- » Material: aço 440C
- » Dureza: 59-61 HRC



» Non inclus: huile, suède, anneaux en caoutchouc ou clé de serrage

» Não inclui: óleo, camurça, anéis de borracha ou chave de aperto



» Coupe
» Corte

6"

REF.07022/70



» Coupe
» Corte

6"

REF.07022





» Non inclus: huile, suède, anneaux en caoutchouc ou clé de serrage

» Não inclui: óleo, camurça, anéis de borracha ou chave de aperto

Ciseaux ISIS Tesoura ISIS

• Matériau : Acier martensitique 420J2
• Dureté : 56HRC

» Material: martensitic steel 420J2
» Hardness: 56HRC



» Coupe
» Corte

6"

REF.07023



» Sculpteur
» Esculpir

6"

REF.07024



» Coupe
» Corte

6"

REF.07023/70



» Sculpteur
» Esculpir

6"

REF.07024/70



Ciseaux MINERVA Tesoura MINERVA

• Matériau : Acier martensitique 420J2
• Dureté : 56HRC

» Material: aço 420J2
» Dureza: 56HRC



» Coupe
» Corte

6"

REF.07026



» Sculpteur
» Esculpir

6"

REF.07025



» Coupe
» Corte

6"

REF.07026/70



» Sculpteur
» Esculpir

6"

REF.07025/70



Ciseaux professionnels · Tesoura profissional

Ciseaux ECLIPSE
Tesoura ECLIPSE

- Matériau : Acier martensitique 420J2
- Dureté : 56HRC

- » Material: aço 420J2
- » Dureza: 56HRC



» Non inclus: huile, suède, anneaux en caoutchouc ou clé de serrage

» Coupe
» Corte

6"

» Sculpteur
» Esculpir

6"

REF.07027/68

REF.07054/68

» Não inclui: óleo, camurça, anéis de borracha ou chave de aperto



» Coupe
» Corte

6"

REF.07027

» Sculpteur
» Esculpir

6"

REF.07054

» Coupe
» Corte

6"

REF.07027/70

» Sculpteur
» Esculpir

6"

REF.07054/70



Ciseaux WAVES avec lames en acier

Tesoura corte aço WAVES

1 u.m.vta
12 box

» Coupe
» Corte

6"

REF.04316



» Sculpteur
» Esculpir

5,75"

REF.04317



Ciseaux professionnel ERGO

Tesoura professional ERGO

1 u.m.vta
12 box

» Coupe
» Corte

6"

REF.04314



» Sculpteur
» Esculpir

6"

REF.04315



Ciseaux de coiffure RUBÍ

Tesorias de cabeleireiro RUBÍ

1 u.m.vta
12 box

» Coupe
» Corte

5"

REF.04319



» Sculpteur
» 25 des dents

5,5"

REF.04401

» Esculpir
» 25 dentes



Ciseaux avec lame de coupe et appuie-doigt WILL
Tesoura fio navalha com pega de dedo WILL



» Coupe
 » Corte

5,5"

REF. 04707

» Coupe
 » Corte

6"

REF. 04708

» Sculpteur
 » Esculpir

6"

REF. 04709



Ciseaux avec lame de coupe pour gauchers MATT
Tesoura com fio navalha canhotos MATT

» Coupe
 » Corte

5,5"

REF.04503

» Sculpteur
 » Esculpir

5,5"

REF.04504

Ciseaux pour GAUCHERS
Tesoura CANHOTOS

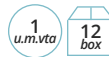

» Coupe
 » Corte

5,5"

REF.02213



Ciseaux COSMOS LINE
Tesoura COSMOS LINE

- Matériau : Acier martensitique 420cr
- Dureté : 51-52HRC. - Finition: mat
- Supporte les doigts amovibles Feuille convexe

- » Material: aço 420Cr
- » Dureza: 51.-52HRC - Acabamento: fosco
- » Suporta dedos removíveis Folha convexa



- » Coupe
- » Corte

5,5"

REF.06815



- » Coupe
- » Corte

6"

REF.06816



- » Sculpteur
- » Esculpir

6"

REF.06817

**Ciseaux EVOLUTE LINE**
Tesoura EVOLUTE LINE

- Matériau : Acier martensitique 420cr
- Dureté : 51-52HRC. - Finition: mat
- Supporte les doigts amovibles Feuille convexe

- » Material: aço 420Cr
- » Dureza: 51.-52HRC - Acabamento: fosco
- » Suporta dedos removíveis Folha convexa



- » Coupe
- » Corte

5,5"

REF.07101



- » Coupe
- » Corte

6"

REF.07102



- » Sculpteur
- » Esculpir

6"

REF.07103

**Ciseaux UTILE LINE**
Tesoura UTILE LINE

- » Matériau : Acier martensitique 420cr
- » Dureté : 51-52HRC. - Finition: mat
- » Supporte les doigts amovibles Feuille convexe

- » Material: aço 420Cr
- » Dureza: 51-52HRC - Acabamento: fosco
- » Suporta dedos removíveis Folha convexa



- » Coupe
- » Corte

5,5"

REF.07104



- » Coupe
- » Corte

6"

REF.07105



- » Sculpteur
- » Esculpir

6"

REF.07106



Ciseaux CORVUS LINE
Tesoura CURVUS LINE

- » Matériau : Acier martensitique 420Cr
- » Dureté : 51-52HRC. - Finition: mat
- » Supporte les doigts amovibles

- » Material: aço 420Cr
- » Dureza: 51-52HRC - Acabamento: fosco
- » Suporta dedos removíveis



Microdentés
Microdentado

- » Accessoires: 'huile, deux bagues en caoutchouc

» Acessórios: óleo, dois anéis de borracha

- » Coupe
- » Corte

5,5"

REF.06818



- » Coupe
- » Corte

6"

REF.06819



- » Sculpteur
- » Esculpir

6"

REF.06820

Ciseaux SCULPTOR LINE
Tesoura SCULPUT LINE

- » Matériau : Acier martensitique 420Cr
- » Dureté : 51-52HRC. - Finition: mat
- » Supporte les doigts amovibles

- » Material: aço 420Cr
- » Dureza: 51-52HRC - Acabamento: fosco
- » Suporta dedos removíveis



Microdentés
Microdentado

- » Accessoires: 'huile, deux bagues en caoutchouc

» Acessórios: óleo, dois anéis de borracha

- » Coupe
- » Corte

5,5"

REF.06822



- » Coupe
- » Corte

6"

REF.06823



- » Sculpteur
- » Esculpir

6"

REF.06824

Ciseaux LOYAL
Tesoura LOYAL

- » Matériau : Acier martensitique 420Cr
- » Dureté : 51-52HRC. - Finition: mat
- » Supporte les doigts amovibles

- » Material: aço 420Cr
- » Dureza: 51-52HRC - Acabamento: fosco
- » Suporta dedos removíveis

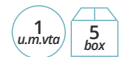

Microdentés
Microdentado

- » Accessoires: 'huile, deux bagues en caoutchouc

» Acessórios: óleo, dois anéis de borracha

- » Coupe
- » Corte

5,5"

REF.07119



- » Coupe
- » Corte

6"

REF.07120



- » Sculpteur
- » Esculpir

6"

REF.07121



Ciseaux NEOSTAR
Tesoura NEOSTAR

» Matériau : Acier martensitique 420J2
» Dureté : 56HRC

» Material: aço martensítico 420J2
» Dureza: 56HRC

1 u.m.vta
10 box



Microdentés
Microdentado

» Coupe
» Corte

5,5"

REF.06964

» Coupe
» Corte

6"

REF.06965

» Sculpteur
» Esculpir

5,5"

REF.06966



» Coupe
» Corte

5,5"

REF.06964/70

» Coupe
» Corte

6"

REF.06965/70

» Sculpteur
» Esculpir

5,5"

REF.06966/70

**Ciseaux satin d'acier inoxydable SATINY**
Tesoura inoxidável SATINY

1 u.m.vta
30 box



Lame micro dentée
Microdentada com uma lâmina

» Coupe
» Corte

5,5"

REF.00725

» Coupe
» Corte

6"

REF.00726

» Coupe
» Corte

6,5"

REF.00727



Ciseaux INOXYDABLE
Tesoura INOXIDÁVEL

 1
 u.m.vta 30
 box

 » Sculpteur
 » Esculpir

5,5"

REF.00724

 » Effiler
 » Desbaste

5,5"

REF.00728

Ciseaux ELEGANT avec lame de coupe noir et manche doré
Tesoura ELEGANT com fio navalha, preta cabo dourado

 1
 u.m.vta 12
 box

 » Coupe
 » Corte

5,5"

REF.04499

 » Sculpteur
 » Esculpir

5,5"

REF.04500

Ciseaux BLACK avec lame de coupe, noir mat
Tesoura BLACK com fio navalha, preta mate

 1
 u.m.vta 12
 box

 » Coupe
 » Corte

5,5"

REF.04501

 » Sculpteur
 » Esculpir

5,5"

REF.04502



Ciseaux professionnels avec manche en alliage et lame satinée DARK GARDEN
Tesoura profissional com cabo liga lâmina satinada DARK GARDEN

1
u.m.vta

12
box

5,5"

REF.03677

- » Sculpteur
- » Esculpir



Ciseaux professionnels avec manche en plastique
Tesoura profissional cabo plástico



Microdentés
Microdentado



1
u.m.vta

12
box

- » Coupe
- » Corte

6"

REF. 01977



- » Sculpteur
- » 30 des dents

6"

REF. 01978

- » Esculpir
- » 30 dentes



- » Coupe
- » Corte

5,5"

REF.00722



- » Coupe
- » Corte

6"

REF.00723



1
u.m.vta

12
box

Ciseaux spéciaux écoles avec manche en plastique

Tesouras especial academia cabo plástico

 Microdentés
Microdentado

 1
u.m.vta
 
 12
box

 » Coupe
» Corte

 5"
REF.02807

 » Coupe
» Corte

 5,5"
REF.02808

 » Sculpteur
» 22 des dents

 6"
REF.02809

Ciseaux INITIATION

Tesouras INICIAÇÃO

 » Coupe
» Corte

 6"
REF.04358

 » Coupe
» Corte

 6,5"
REF.04359

 » Coupe
» Corte

 1
u.m.vta
 
 12
box

 7"
REF.04360

 » Sculpteur
» Esculpir

 6,5"
REF.04361

Coffret de 2 ciseaux de coupe /sculpteurs
Estojo 2 tesouras corte/esculpir



6"

REF.06821



6"

REF.06825



Coffret FLASH de 2 ciseaux de coupe /sculpteurs
Estojo FLASH 2 tesouras corte/esculpir

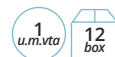

5,5"

REF.07107



Étui en simili cuir Estujo semi-pele

1 u.m.vta
12 box

Étui en simili cuir avec:

- » Ciseaux de coupe avec lame de rasage
- » Ciseaux sculpteur
- » Rasoir à lames interchangeables 00698
- » Peigne professionnel 00115.

Estujo em semi-pele com:

- » Tesoura corte fio navalha
- » Tesoura esculpir
- » Navalha de lâminas trocáveis 00698
- » Pente profissional 00115.



5,5"

REF.03267

Kit de coupe de cheveux pour les étudiants Kit corte estudantes

Étui avec:

- » 1 ciseaux de coupe
- » 1 ciseaux sculpteur
- » 1 rasoir coupe choux en métal
- » Lame de rasoir

Estujo em semi-pele com:

- » 1 tesoura corte
- » 1 tesoura esculpir
- » 1 navalha metálica
- » Lâmina de navalha



6"

REF.04901

Coffret de 2 ciseaux de coupe /sculpteurs Estujo 2 tesouras corte/esculpir

- » Ciseaux brillants
- » Tesouras nrilhantes

1 u.m.vta
12 box

5,5"

 Microdentés
Microdentado

REF.03682



Coffret porte - étui pour 20 unités (vide)
Estojo porta tesouras por 20 unidades (vazio)



REF.04634



Conteneur pour ciseaux
Recipiente para tesoura



REF.04740



Présentoir pour ciseaux
Expositor tesouras



REF.04074

- » Méthacrylate
- » Metacrilato



Rasoir à cheveux
Corta cabelos

- » Une lame
- » Uma folha

REF.00961



- » Deux lames
- » Duas folhas



REF.00962



Boîte de 100 rasoirs jetables Pollié avec protection
Caixa 100 navalhas descartáveis Pollié com protetor

- » Avec protecteur
- » Com protetor



REF.02480



10 Boîtes de 10 lames professionnelles Eurostil styling blades

10 Caixas de 10 lâminas profissionais Eurostil styling blades



La lame est en acier inoxydable de haute qualité et a été traitée avec un bain au platine afin de la rendre plus résistante, et avec un bain au téflon pour qu'elle soit plus douce. Cela crée une sensation plus agréable lors du rasage. Vendues dans une boîte en plastique qui protège les lames.

A folha é feita em aço inoxidável de elevada qualidade banhada a platina o que faz com que a lâmina dure mais, com uma camada também de teflon o que torna o barbear mais suave e dá uma sensação mais confortável ao barbear. São vendidas numa caixa de plástico que protege a lâmina.



Lames de rasoir haute performance:
01498 -04073- 04075

Descartáveis para as navalhas:
01498 -04073- 04075

Prix de 10 cartons de 10 feuilles: 26 €
Distributeur de 10 feuilles 2,6 €

Preço de 10 caixas com 10 folhas: 26€
Dispensador de 10 folhas 2,6€



NEW

REF.07123

» Téflonné
» Com uma camada de teflon

Rasoirs

Navalhas

» Navaja metálica color plata
» Silver metallic razor



REF.02535/54



» Métallique bleu
» Avec protecteur



REF.04073

» À manche en plastique
» Avec protecteur



REF.04075

» Cabo en plástico
» Com protetor

» En métal argenté
» De metal prateado



REF.01498



Rasoirs FEATHER STYLING
Navalhas FEATHER STYLING1
u.m.vta6
box

REF.04386

» Short Silver
» Short silver

REF.04387

**Boîte de 10 lames STYLING RAZORS · Caixa 10 lâminas STYLING RAZORS**1
u.m.vta5
box

REF.07159

1
u.m.vta5
box

REF.04388

1
u.m.vta5
box

REF.04389

Lames de rasoir haute performance : 04386 - 04387
Descartáveis para as navalhas: 04386 - 04387**Rasoirs FEATHER STYLING RAZOR**
Navalhas FEATHER STYLING RAZOR1
u.m.vta6
box

REF.04394

**Distributeur de 20 lames**
Dispensador 20 lâminas**Professional PB-20**1
u.m.vta10
box

REF.04391

Boîte de 10 lames NAPE
Caixa 10 lâminas NAPE1
u.m.vta10
box

REF.04395



Extensions et mèches

EXTENSÕES E
BANDA TISSAGEM

*Mèches, extensions, clips,
anneaux de cheveux, adhésif
capillaire, dissolvant...*

*Madeixas, extensões, clips,
anéis, adesivo, dissolvente...*



Mèches de cheveux remy naturel

Banda tissagem de cabelo natural remy

1 u.m.vta
10 box

10 cm



50 cm

» Poids mèches de cheveux
98-100 gr aprox.

» Peso 98-100 gr aprox.



» Noir
» Preto

N°1

REF.03354



» Marron rouge
» Reddish

N°30M

REF. 03363

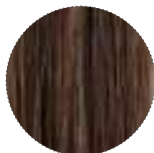

» Brun cuivré
» Castanho cobre

N°10

REF.03357



Mèches de cheveux Remy naturel avec clip

Madeixas de cabelo natural Remy com clip

1 u.m.vta
6 box

15 cm



50 cm

» Postiche de largeur 15cm /
longueur 50 cm
» Cheveux Remy
» Longueur clip 2,8 mm
» Poids : 20 grammes (clips inclus)

» 15 cm de largura com 3 clips e
50 cm de comprimento
» Cabelo remy
» Cada clip é de 2,8 mm
» Peso: aprox. 20 gramas (com
os clips)



x3

» Rougeâtre
» Avermelhado

N°30M

REF.03650

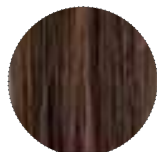

» Brun rouge
» Castanho avermelhado

N°30

REF.03651



» Brun cuivré
» Castanho cobre

N°10

REF.03644



Extensions de kératine

Extensões queratina

1 u.m.vta
6 box



50 cm

»Pack 20 Extensions de 50 cm de long
»Cheveux Remy
»Kératine
»Poids : 14g. env.

»Pack 20 extensões de 50cm de
comprimento
»Cabelo Remy
»Queratina
»Peso: aprox 14g

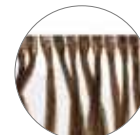

» Brun cuivré
» Castanho cobre

N°10

REF.03369



» Brun foncé cuivré
» Castanho cobre escuro

N°32

REF.03377

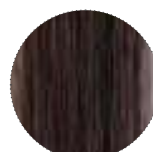

Pot contenant des anneaux en aluminium gravé
Anéis de alumínio gravado para extensões

100 unités
100 unidades



» Noir
» Pretos

N°1

REF.02911



» Brun foncé
» Castanho escuro

N°3

REF.02912



» Marron moyen
» Castanho médio

N°5

REF.02913



» Blond foncé
» Loiro escuro

N°1

REF.02914



» Blond Platine
» Loiro platina

N°3

REF.02915



» Bordeaux
» Bordeaux

N°5

REF.02927



Pot contenant des anneaux en aluminium gravé
Anéis de alumínio gravado para extensões

1000 unités
1000 unidades



» Noir
» Pretos

N°1

REF.02867



» Brun foncé
» Castanho escuro

N°3

REF.02868



» Marron moyen
» Castanho médio

N°5

REF.02869



» Blond foncé
» Loiro escuro

N°1

REF.02870



» Blond Platine
» Loiro platina

N°3

REF.02871



» Bordeaux
» Bordeaux

N°5

REF.02921



Sachets de clips pour extensions 3,2 cm**Bolsas de clips de extensões 3,2 cm**» Noir
» Pretos

50 u

REF.02924/50



4 u

REF.03269/50

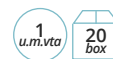
» Marron
» Castanho

50 u

REF.02924



4 u

REF.03269



3,2 cm



3,2 cm

» Argenté
» Prata

50 u

REF.02924/54



4 u

REF.03269/54

» Blond
» Loira

50 u

REF.02924/66



4 u

REF.03269/66



3,2 cm



3,2 cm

Sachets de clips pour extensions 2,8 cm**Bolsas de clips de extensões 2,8 cm**» Noir
» Pretos

50 u

REF.03306/50



4 u

REF.03270/50

» Marron
» Castanho

50 u

REF.03306



4 u

REF.03270



2,8 cm



2,8 cm

» Argenté
» Prata

50 u

REF.03306/54



4 u

REF.03270/54

» Blond
» Loira

50 u

REF.03306/66



4 u

REF.03270/66



2,8 cm



2,8 cm

Sachet de clips pour extensions 2,2 cm**Bolsa de clips de extensões 2,2 cm**

» Noir
» Pretos



— 2,2 cm —

1 u.m.vta 20 box

50 u

REF.03307/50

12 u.m.vta 12 box

4 u

REF.03271/50

» Marron
» Castanho



— 2,2 cm —

1 u.m.vta 20 box

50 u

REF.03307

12 u.m.vta 12 box

4 u

REF.03271

» Argenté
» Prata



— 2,2 cm —

1 u.m.vta 20 box

50 u

REF.03307/54

12 u.m.vta 12 box

4 u

REF.03271/54

» Blond
» Loira



— 2,2 cm —

1 u.m.vta 20 box

50 u

REF.03307/66

12 u.m.vta 12 box

4 u

REF.03271/66

Adhésif pour postiches**Adesivo para fixar bandas tissagem ao cabelo**

» À base de latex naturel.
» Couleur de l'adhésif est sombre.

» À base de látex natural.
» Cor da cola escura.



50 ml

REF.03176/50

» À base de latex naturel.
» Couleur de l'adhésif est blanc.

» À base de látex natural.
» Cor da cola branca.



50 ml

REF.03176/58

1 u.m.vta 12 box

Dissolvant extensions kératine**Solvente de queratina das extensões**

1 u.m.vta 20 box

150 ml

REF.03164

Dissolvant adhésif postiches**Solvente de cola das bandas tissagem**

1 u.m.vta 20 box

150 ml

REF.03177

Sachet de disques pour extensions
Bolsa de discos para extensões

1 u.m.vta
60 box

12 u

REF.02582



Sachet de crochets
Bolsa de ganchos para anéis

1 u.m.vta
5 box

12 u

REF.02873



Pince pour extensions
Alicate para extensões

1 u.m.vta
60 box

- » Poignée bicolore
- » Manga bicolor

REF.02872



Pince spéciale pour extensions
Alicate especial para extensões

1 u.m.vta
60 box

- » Avec anneaux
- » Com anel

REF.02581



Nuancier extensions
Expositor de cores de extensões

1 u.m.vta
20 box

REF.03378



Kit d'extensions
Kit extensões

1 u.m.vta
12 box

REF.04208



12

Divers

VÁRIOS

*Serviettes, valises,
pulvérisateurs, cotons...*

*Toalhas, malas,
pulverizadores, algodões...*



1 Kg de coton de coiffure en rouleaux
1 Kg algodão cabeleireiro em rolos

- » 9 morceaux de 3,5 cm (embouts inclus)
- » 9 cortes de 3,5 cm (pontas incluídas)



REF. 00964 REF. 00964/00

Anonyme
Anônimo

- » De taille large.
- » 4 coupures (embouts inclus)

REF. 04290

- » Largura.
- » 4 cortes (pontas incluídas)



- » Plié.
- » 9 morceaux de 3,5 cm (bouts inclus)

REF. 04288

- » Dobrável.
- » 9 cortes de 3,5 cm (pontas incluídas)



Sac de coiffure noir
Bolsa cabeleireiro cor preto

1 u.m.vta
6 box
REF. 02517



1 u.m.vta
10 box
REF. 02596

Sac porte-outils noir
Bolsa porta ferramentas cor preto

1 u.m.vta
5 box

REF. 02516

**Sac - sac à dos pour académie**
Bolsa / mochila para academia

1 u.m.vta
15 box

Sac noir en toile avec crochet et lanières pour le transformer en sac à dos. Il possède une anse pour le porter en sac à main et également une bandoulière pour le porter à l'épaule. Il possède 2 compartiments et un porte-carte.

Cómoda mala cor preto de tecido com asa e com tiras para poder usar como mochila. Possui uma alça para levar como mala de mão e também uma alça para pendurar ao ombro. Inclui 2 divisórias e espaço para papéis.

REF. 07018

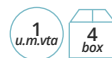

Valise en aluminium
Mala alumínioToutes les valises sont vendues vides
Todas as malas são vendidas vazias

- » Pour outils, à intérieur transparent et 4 plateau
- » Para ferramentas, interior transparente e 4 bandejas



REF.03598

- » Pour outils, à l'intérieur se trouve 6 compartiments et 4 plateaux
- » Para ferramentas, interior 6 compartimentos e 4 bandejas



REF.03599



REF. 02319

REF.02318



REF.04307



Valise en aluminium
Mala alumínioToutes les valises sont vendues vides
Todas as malas são vendidas vazias

REF.02317

» Porte-outils
» Porta-utensílios

REF.01497



REF.01492

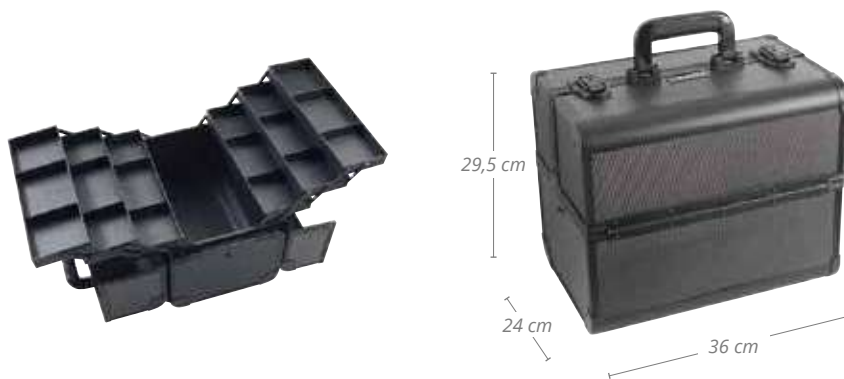

REF.04306

Valise noire en PVC
Mala alumínioToutes les valises sont vendues vides
Todas as malas são vendidas vazias

REF.02925

Valise professionnelle grise en mélanine
MALA profissional cinza melanina

REF.02593

Valise trolley
Mala trolley

REF.02523/50



REF.02929/50

REF.02929

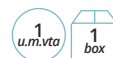

Valise trolley de coiffeur en skai
Mala trolley pele ecológica cabeleireiroToutes les valises sont vendues vides
Todas as malas são vendidas vazias

REF.04308

**Valise trolley de coiffeur en SKAI CROCODILE**
Mala trolley pele ecológica Cabeleireiro CROCODILOToutes les valises sont vendues vides
Todas as malas são vendidas vazias

REF.06136

- » 3 grands compartiments avec 2 plateaux au sommet avec des trous pour mettre les ustensiles.
- » 4 roues pour le déplacer facilement
- » Avec roues amovibles

- » 3 grandes compartimentos com 2 bandejas no topo com furos para colocar utensílios.
- » 4 rodas para movê-lo com facilidade e facilidade
- » Com rodas removíveis



Sac de coiffure avec des roues
Bolsa cabeleireiro com rodas1
u.m.vto1
box» Avec la structure métallique qui permet d'utiliser la valise comme siège
» Com estrutura metálica que permite usar a MALA como assento**Trousse à maquillage (vide) incluse dans**
Beauty case (vazio) incluido na

REF.04402/50



REF.04402/80

Valise trolley
Mala trolley1
u.m.vto1
box

REF.03814/68



REF.03814/50



Valise trolley 4 compartiments
Mala 4 corposToutes les valises sont vendues vides
Todas as malas são vendidas vazias

- » Chaque compartiment dans sa base inférieure, sauf la dernière qui possède des roues. L'intérieur est recouvert de mousse noire. Poignée réglable en hauteur selon le besoin.
- » 1er et 2ème compartiment: env. 24,5 x 21,5 x 9 cm de hauteur. Comprend 2 séparateurs latéraux avec guides pour adapter l'espace à nos besoins.
- » 3ème compartiment: env. 24,5 x 21,5 x 35 cm de hauteur.
- » 4ème compartiment: env. 24,5 x 21,5 x 18 cm de haut.

- » Cada corpo tem na sua base inferior quatro patas, exceto o último que tem rodas. Interior coberto de espuma preta. Asa regulável em altura em função da necessidade de corpos.
- » 1º e 2º corpo: aprox. 24,5 x 21,5 x 9 cm de altura. inclui 2 separadores laterais com guias para adaptar o espaço às suas necessidades.
- » 3º corpo: aprox. 24,5 x 21,5 x 35 cm de altura.
- » 4º corpo: aprox. 24,5 x 21,5 x 18 cm de altura.

**Double valise en nylon équipée de roues.**
Mala de nylon duplo com rodas.

La valise supérieure peut être transformée en un sac à main. Elle a une sangle qui permet de l'accrocher à l'épaule. Deux compartiments intérieurs qui peuvent être déplacés. Offre beaucoup d'espace de rangement. Intérieur plastifié facile à nettoyer. Grande poche extérieure. La valise inférieure est équipée de roues. Son intérieur est également plastifié.

Livrée avec un porte-pinceaux cosmétiques fixé au moyen d'un velcro qui peut être déplacé. Elle est équipée de 8 compartiments intérieurs amovibles pour ranger les produits.

Une poche extérieure sur chaque côté. La position des deux valises peut être inversée.

A parte superior pode ser convertida em uma bolsa de mão, que vem com uma alça para pendurar no ombro. Tem duas bandejas internas que podem ser movidas para os lados, o interior é largo e a parte inferior é removível e está plastificada para facilitar a limpeza da mala. Também na parte de trás tem um bolso externo. A caixa de baixo com rodas tem a parte interior plastificada e é removível para facilitar a limpeza, vem com um porta-escovas que é preso por um velcro. Este porta-escovas pode ser trocado entre a mala superior e inferior. Tem 8 gavetas para armazenar e separar pequenos produtos. Tem um bolso de cada lado. Cada coluna integra 4 gavetas que estão unidas em uma única peça, elas são removíveis.



Valise trolley 4 compartiments

Mala 4 corpos

Toutes les valises sont vendues vides
Todas as malas são vendidas vazias



La valise trolley de Pollié, est créée sur la base d'une structure de 2 corps modifiables, conçue pour faciliter le rangement professionnel de vos ustensiles de coiffure, de maquillage ou de cosmétique.

Le haut de la valise se compose de trois plateaux amovibles. Chacun d'eux est divisé en trois compartiments. Ainsi, dans l'un d'eux, vous trouverez douze espaces circulaires conçus pour stocker les laques à ongles et ainsi empêcher leur détachement, facilitant leur transport en toute sécurité. De plus, l'intérieur du haut du corps peut être modifié selon vos besoins, en variant la structure des compartiments. Enfin, sa fonction 2 en 1 leur permettra d'avoir un sac à main, ou ils préfèrent l'accrocher à l'homme, grâce à sa bande en nylon.

La partie inférieure de la valise a un plateau amovible avec l'option de 4 compartiments qui peuvent également être modifiés grâce aux entretoises. Le bas du corps, avec une grande capacité à l'intérieur, vous donnera la possibilité d'un transport plus léger, car il peut être converti en une valise plus petite, avec un couvercle et un miroir incorporés. Les roues sont interchangeables à l'aide de la languette d'attelage. Le chariot a deux bobines et deux clés de rechange

A mala de carrinho de Pollié é criada com base em uma estrutura de 2 corpos modificáveis, projetados para facilitar o armazenamento profissional de seus utensílios de cabeleireiro, maquiagem ou cosméticos.

A parte superior da mala consiste em três bandejas removíveis. Cada um deles é dividido em três compartimentos. Assim, em um deles, você encontrará doze espaços circulares projetados para armazenar vernizes de unhas e, assim, impedir seu desapego, facilitando o transporte com total segurança. Além disso, o interior da parte superior do corpo pode ser modificado de acordo com suas necessidades, variando a estrutura dos compartimentos. Finalmente, sua função 2-em-1 permitirá que eles tenham uma bolsa, ou eles preferem pendurá-la no homem, graças à sua tira de nylon.

A parte inferior da mala possui uma bandeja removível com a opção de 4 compartimentos que também podem ser modificados graças aos espaçadores. A parte inferior do corpo, com grande capacidade interna, oferece a opção de transporte mais leve, pois pode ser convertida em uma mala menor, com tampa e espelho incorporados. As rodas são intercambiáveis usando a aba do engate. O carrinho possui duas bobinas e duas chaves sobressalentes.

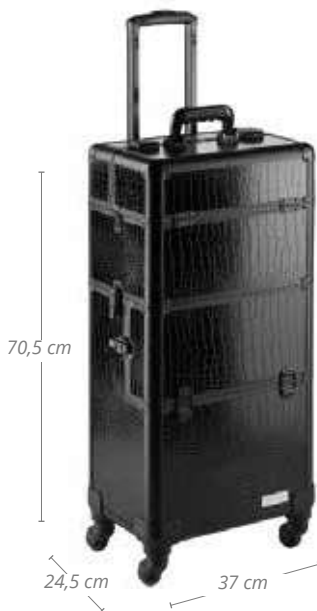

REF.04939/50



REF.04939



Étui porte-outils noir
Estojo porta-utensílios preto

Toutes les Porte-outils sont vendues vides
 Todas as Porta-utensílios são vendidas vazias



REF. 01238



REF. 01236



REF. 01237



REF. 02515



REF. 02513



REF. 02514



Ceinture porte-outils
Cinturão porta-utensílios

Toutes les Porte-outils sont vendues vides
 Todas as Porta-utensílios são vendidas vazias

- » A vec 5 combinables
- » com 5 combinações

1 u.m.vta
48 box

REF.03622



1 u.m.vta
48 box

REF.04310

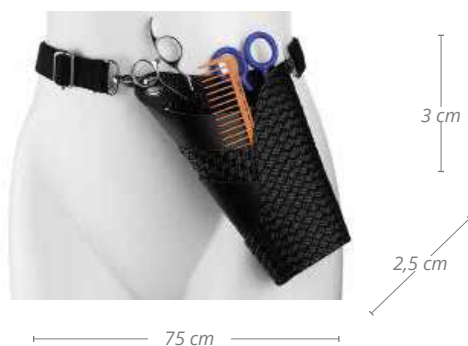

Boîte 50 unités de protection faciale FacePro
Caixa 50 unidades protetor facial FacePro**Articles en vente exclusive en ESPAGNE, AU PORTUGAL ET ANDORRE**
Artigos exclusivo de venda EM ESPANHA, PORTUGAL E ANDORRA

REF. 04480



REF. 04223

Biologique
Orgânico**NON Biologique**
NÃO Orgânico**Face pro protège le visage des cheveux coupés, de la laque, de l'air chaud du séchoir, des colorants ...**
Face pro protege o rosto do cabelo cortado, da laca, do ar quente do secador, tintas...**Boîte de rangement accessoires coiffure (vide)**
Caixa organizadora (Vazia)Vides
vazia

REF.04722

» Aimanté
» Magnetizado

REF.04309

**Porte carte visite aluminium**
Estojo para cartoes

REF.02470

Porte-sac à main
Ganchos para bolso

REF.03304



Porte-outils en silicone
Porta-utensílios em silicone1
u.m.vta 48
box» Avec ventouses
» Com ventosas1
u.m.vta 6
box

REF.04370



REF.04404/68



REF.04404/50

Protecteur visage
Protetor facial20
u.m.vta 20
box**Miroirs**
Espelhos1
u.m.vta 12
box

REF.00287



REF.01233

**Miroirs**
Espelhos1
u.m.vta 12
box

REF.00286

1
u.m.vta 6
box

REF.02538/54

1
u.m.vta 1
box

REF.03626

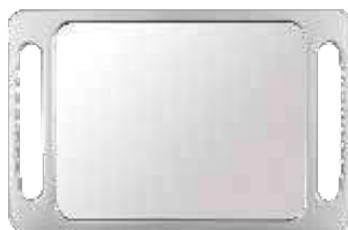

Porte-perruque

Porta perucas

Ø 59



REF. 03489



REF. 04367



Ø 16 - 17



» Porexpan
» Porexpan

Porte-perruque

Porta perucas



REF. 00982

- » Pliant
- » De voyage
- » Dobrável
- » Viagem

Ø 17,5

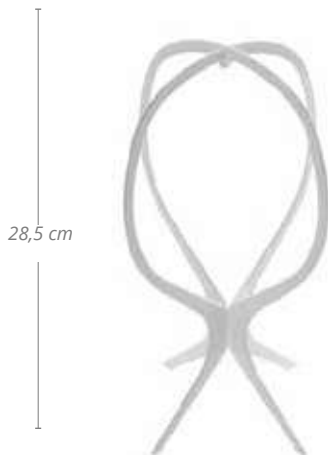

REF. 00982/50

Pulvérisateur Stil

Pulverizador Stil



REF. 02683

- » Transparente
- » Transparente

260 ml



Pulvérisateur de couleurs transparentes Pulverizador cores transparente



330 ml
● ● ●
REF.00959

300 ml
● ● ●
REF.01372

» Rond
» Redondo

300 ml
● ● ●
REF.01484

300 ml
● ● ●
REF.01663



Pulvérisateur 360° Pulverizador 360°



300 ml
REF.04731

Pulvérisateur désinfectant continu Pulverizador de desinfetante contínuo



NEW

300 ml
REF.07247

- » Spray continu : avec une seule pression, il pulvérise l'eau de manière fine et uniforme, avec la même pression du début jusqu'à la dernière goutte.
- » 360° : il peut être utilisé depuis tous les angles, y compris la tête en bas. Pulvérisation fine, type brume, qui distribue l'eau de manière uniforme sur tous les cheveux.
- » Capacité : 300 ml rechargeable.
- » Volume fixe de pression : 1,25 cc continu.
- » Évite la fatigue de la main par rapport à d'autres spray standards. Sans gaz contaminant.



- » Spray continuo: com uma só pressão pulveriza a água de forma fina e uniforme com a mesma pressão desde o início até à última gota.
- » 360°: pode-se usar desde todos os ângulos, inclusive voltado para baixo. Pulverização fina, tipo nevoeiro que distribui a água de forma uniforme sobre todo o cabelo.
- » Capacidade: 300 ml Pode ser enchido novamente.
- » Volume fixo de pressão: 1,25 cc contínuo.
- » Evita a fadiga comparativamente aos sprays standard. Sem gases contaminantes.



Pulvérisateur d'aluminium Pulverizador alumínio

» Intérieur laqué
» Interior lacado

23,5 cm



1
u.m.vta

35
box

280 ml

REF.01384

» Neutre
» Neutro



1
u.m.vta

35
box

280 ml

REF.01384/02



Présentoir de 30 pulvérisateurs d'aluminium Expositor 30 pulverizadores alumínio



1
u.m.vta

1
box



280 ml

REF.01465

280 ml

REF.01465/02

Pulvérisateur en plastique Pulverizador de plástico

» Avec pendentif
» Com suspensão



1
u.m.vta

80
box

130 ml

REF.03401



» Diffuseur noir japonais
» Difusor preto japonês



1
u.m.vta

24
box

300 ml

REF.04377



Serviette 100% coton
Toalha 100% algodão12
u.m.vta48
box

380 gr

REF. 02947/50

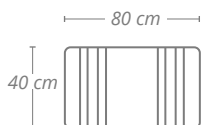

REF. 02947/58

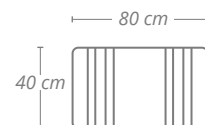

REF. 02901/50

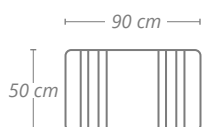

REF. 02901/58

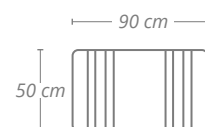
» Résistant à l'eau de Javel
» Lixívia resistente

REF. 04953/50

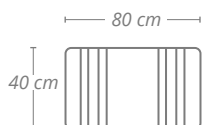

NEW

REF. 06829/50

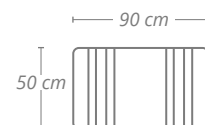

Gel hydro-alcoolique À l'Aloe Vera

Gel hidroalcoólico com Aloe Vera



NEW

1 u.m.vta 40 box

100 ml

REF.07245

NEW

1 u.m.vta 20 box

500 ml

REF.07235

NEW

1 u.m.vta 12 box

1 L

REF.07267

NEW

1 u.m.vta 2 box

5 L

REF.07268



Solution hydro-alcoolique

Solução hidroalcoólica

NEW

1 u.m.vta 63 box

100 ml

REF.07174

NEW

1 u.m.vta 23 box

500 ml

REF.07175

NEW

1 u.m.vta 7 box

1 L

REF.07259

NEW

» Avec pompe de dosage

» Con bomba doseadora

1 u.m.vta 7 box

1 L

REF.07213



Gel hidro-alcoolico Gel hidroalcoólico



NEW

REF.07215



Alcool 96° Álcool 96°



NEW

REF.07217



Pompe de dosage gel 1 l / 500 ml Bomba doseadora gel 1l / 500 ml

Idéale pour mélanger avec de l'eau et mettre dans un pulvérisateur pour nettoyer et désinfecter les surfaces

Idéal para misturar com água e pôr num pulverizador para limpar e desinfetar superficies



REF.RE07267



Désinfectant pour les mains en spray Higienizante de mãos em spray

Pour désinfecter les mains sans besoin d'eau ni de savon. Conçu pour toujours avoir les mains propres et les protéger des facteurs externes. Contenu élevé en glycérine qui agit comme agent hydratant sur la peau. USAGE EXCLUSIF SUR PEAU SAINE

Para higienizar as mãos sem a necessidade de água e sabão. Formulado para manter as mãos limpas a qualquer momento, protegendo-as de fatores externos. Elevado conteúdo em Glicerina que atua como hidratante para a pele. UTILIZAÇÃO EXCLUSIVA SOBRE A PELE SAUDÁVEL.

NEW

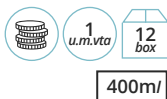

REF.07231



Boîte présentoir 120 sachets avec lingette désinfectante Caixa expositora 120 saquetas com toalhita higienizante

Nettoyage sans eau. Pour une peau saine et propre partout

Limpeza sem água. Para uma pele saudável e limpa em qualquer parte



REF.07236

NEW



Articles en vente exclusive en ESPAGNE
Artigos exclusivo de venda EM ESPANHA

Antiseptique daromix gh
Antiséptico daromix gh



500 ml

REF.06200



- » Numéro d'enregistrement AEMPS: 905-DE5
- » Antiseptique hydroalcoolique pour la désinfection hygiénique des mains par friction.
- » Efficacité scientifiquement garantie
- » Biocide à large spectre de 30 sec.
- » Formule hypoallergénique
- » Préserve l'hydratation de la peau
- » N'irrite pas la peau
- » Sèche rapidement
- » Efficace comme: Bactéricide · Levuricide · Virucide · Microbactéricide
- » Número de registo AEMPS: 905-DE5
- » Anti-séptico hidroalcoólico para desinfeção higiênica de mãos por fricção.
- » Eficácia cientificamente garantida
- » Biocida de amplo espectro a partir de 30 seg.
- » Fórmula hipoaergênica
- » Preserva a hidratação da pele
- » Sem irritação na pele
- » Secar rapidamente
- » Eficaz como: Bactericida · Levuricida · Virucide · Microbactericida

Désinfectant au limoseptol
Desinfetante limoseptol



50 ml

REF. 06151



1 L

REF.06150



- » Numéro d'enregistrement AEMPS: 47-DE5
- » Produit de haut niveau développé exclusivement pour l'hygiène,
- » nettoyage et désinfection, pour les ustensiles professionnels de salon de beauté.
- » Action détergente - Large spectre
- » Biodégradable - Sans phosphates et sans formol
- » Efficacité germicide et SANITIZER contre: Bactéries, levures et champignons.
- » Número de registo AEMPS: 47-DE5
- » Produto de alto nível desenvolvido exclusivamente para higiene,
- » limpeza e desinfeção, para utensílios profissionais de salão de beleza.
- » Ação detergente - amplo espectro
- » Biodegradável - sem fosfatos e sem FORMOLO
- » Eficácia germicida e SANITIZER contra: Bactérias, leveduras e fungos.

Tapete desinfetante de calçado

Tapis désinfection pour semelles de chaussures

1 u.m.vta
12 box

REF.07234

Tapis extra-plat de seulement 1 cm de hauteur pour éviter les chutes, fabriqué en polypropylène sur une base en caoutchouc et un conteneur en aluminium ionisé. Dimensions : 60 cm de largeur x 40 cm de longueur x 1 cm d'épaisseur/hauteur.

Mode d'emploi : placer le tapis sur une surface plane et nivelée, appliquer dans le plateau environ 700 ml de liquide désinfectant. Il est recommandé de placer un paillason après le plateau pour que le client puisse ensuite s'essuyer les pieds.

Tapete extraplano com apenas 1 cm de altura para evitar que alguém tropece em polipropileno sobre uma base de borracha e contendor de alumínio oxidado. Medidas: 60 cm largura x 40 cm profundidade x 1 cm altura/espessura

Como utilizar: colocar o tapete sobre uma superfície plana e nivelada aplicar na bandeja cerca de 700 ml de líquido desinfetante. Aconselhamos colocar um tapete fofo à frente deste tapete para secar o calçado do cliente.

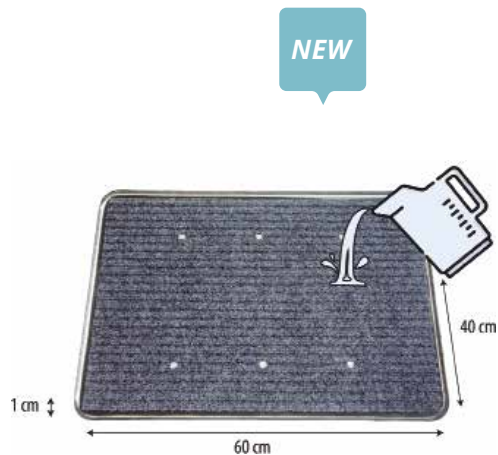

Lunettes de protection antibuée

Tapete desinfetante de calçado

1 u.m.vta
50 box

REF.07256

- » Protection pour prévenir les infections elles protègent efficacement des éclaboussures, des poussières, etc...
- » Lieu d'utilisation : tous les endroits qui nécessitent une protection des yeux.
- » Design innovant, confortable. Elles s'ajustent parfaitement à toute les formes et tailles de tête.
- » Elles peuvent être utilisées en même temps que des lunettes de vue.
- » Certificat CE
- » Matière : plastique

- » Proteção para prevenir infeções: protegem eficazmente contra salpicos,
- » cascalho, etc.
- » Local de utilização: qualquer lugar onde se requeira proteção para os olhos.
- » Design inovador cómodo. Ajustam-se perfeitamente a qualquer forma e tamanho
- » de cabeça.
- » Podem-se utilizar por cima dos seus óculos graduados.
- » Certificado CE
- » Material: plástico



Sac 100 couvre-chaussures

Embalagem 100 cobre-sapatos

1 u.m.vta
50 box

REF.07211

- » À usage unique
- » Plastique
- » Uma só utilização
- » Plástico



Distributeur gel automatique mural avec plateau
Dispensador gel automático de pared com bandeja



Distributeur gel automatique de table
Dispensador gel automático de mesa



Distributeur automatique de gel mural avec support
Dispensador gel automático com pé



Distributeur mural manuel
Dispensador de parede manual



- » Matière : ABS
- » Type de pompe : goutte-à-goutte de gel
- » Source d'alimentation : 4 piles (LR14 taille C)
- » Distance de détection : 6-10 cm.
- » Sortie : 0,8 - 1 ml réglable

- » Material: ABS
- » Tipo de bomba: gotas de gel
- » Fonte de alimentação: 4 pilhas (LR14 tamanho C)
- » Distância de detecção: 6-10 cm.
- » Saída: 0,8-1 ml ajustável

Balais en caoutchouc Vassouras de borracha

- » Avec languette
- » Com aba



4
u.m.vta

16
box

REF.01223



5
u.m.vta

20
box

REF. 01285/50

- » Facile à nettoyer et durable, l'efficacité de la conception de ses pointes parvient à faire glisser la poussière sans la soulever, ce qui la rend idéale pour les personnes allergiques car elles favorisent un environnement propre.

5
u.m.vta

20
box

REF.02420

- » Fácil de limpar e duradoura, a eficácia do design de seus espigões consegue arrastar o pó sem levá-lo, tornando-o ideal para quem sofre de alergias, pois favorece um ambiente limpo.



Manche à balai Punho vassoura

- » Nettoyage facile et longue durabilité
- » Support plastique
- » Idéal pour tous les types de sols, en particulier le parquet

12
u.m.vta

12
box

REF.01131

- » Extra télescopique
- » Telescópico extra

10
u.m.vta

10
box

REF.01365

- » Limpeza fácil e longa durabilidade
- » Suporte de plástico
- » Ideal para todos os tipos de pisos, especialmente parquet







Barbier

BARBERÍA



01 Appareils électriques Aparelhos elétricos 370

Tondeuse cheveux RAGNAR · Máquinas de corte RAGNAR	371
Tondeuse cheveux BARBER LINE	374
Máquinas de corte BARBER LINE	
Tondeuse cheveux CAPTAIN COOK	375
Máquinas de corte CAPTAIN COOK	
Tondeuse cheveux et retouch EUROSTIL	376
Máquinas de corte e retoque	
Tondeuse e retouche RAGNAR	378
Máquinas de retoque RAGNAR	
Tondeuse a retouche CAPTAIN COOK	379
Máquinas de retoque CAPTAIN COOK	
Tondeuse a retouche RAGNAR 360°	382
Máquinas de corte de acessórios RAGNAR 360°	
Tondeuse a retouche CAPTAIN COOK 360°	383
Máquinas de retoque CAPTAIN COOK 360°	
Tondeuses à barbe RAGNAR, BARBER LINE, CAPTAIN COOK	384
Máquinas de barbear RAGNAR, BARBER LINE, CAPTAIN COOK	
Tondeuse nez · Aparador nariz	387
Accessoires coupeuses (CLIPP-AID y huiles)	388
Máquinas de corte de acessórios (CLIPP-AID and óleos)	
Sèches-cheveux, chauffe-cire, fer à lisseur	390
Secador, fusor de cera, alisador de cabelo	
Aspirateur · Aspirador de pó	394
Stérilisateur · Esterilizadores	395

02 Rasoirs et rasoirs Navalhas e lâminas 398

Rasoir RAGNAR · Máquina de barbear RAGNAR	399
Rasoir BARBER LINE · Máquina de barbear BARBER LINE	401
Rasoir CAPTAIN COOK · Máquina de barbear CAPTAIN COOK	405
Rasoir EUROSTIL · Máquina de barbear EUROSTIL	407
Rasoir FEATHER/ lames rasoirs	408
Máquina FEATHER / lâminas Navalhas	
Lames rasoirs · Lâminas navalhas	409
Rasoir jetables · Navalhas descartáveis	412
Pen razor, mousses et gels	413
Pen razor, espumas e géis	

03 Ciseaux Tesouras 414

Ciseaux RAGNAR · Tesouras RAGNAR	416
Ciseaux CAPTAIN COOK · Tesouras CAPTAIN COOK	418
Ciseaux BARBER LINE · Tesouras BARBER LINE	421
Ciseaux EUROSTIL · Tesouras EUROSTIL	422
Ciseaux initiation · Tesouras iniciação	424
Ciseaux spéciaux pour gauchers	425
Tesouras especial canhotos	

04 Brosses & blaireaux rasage Escovas & pincéis 426

Brosses · Escovas	427
Talco · Talc	429
Brosses BARBER LINE	430
Escovas BARBER LINE	
Brosses EUROSTIL	434
Escovas EUROSTIL	
Brosses CAPTAIN COOK	435
Escovas CAPTAIN COOK	

05 Peignes Pentes 436

Peignes RAGNAR · Pentes RAGNAR	437
Peignes CAPTAIN COOK · Pentes CAPTAIN COOK	440
Peignes BARBER LINE · Pentes BARBER LINE	441
Peignes EUROSTIL · Pentes EUROSTIL	442
Peignes carbone · Pentes carbono	443
Peignes SILKOMB · Pentes SILKOMB	444
Peigne niveaux/Brosse de nettoyage peigne	445
Pente com níveis/Escova de limpeza pentes	

06 Cosmétique Cosméticos 446

CAPTAIN COOK	447
THE SHAVING CO	457
MR.BEAR FAMILY	461
OSMA	463
MYRSOL	464
LEGEND	469
TASSEL	470

07 Mobilier et décoration Mobiliário e decoração 474

Enseigne de barbier · Pólos barbeiro	475
Fauteuil de coiffure · Novo cadeira de barbeiro	476
Post-Lavages · Rampa de lavagem	481
Chaises coiffeur enfants · Assentos para crianças	483
Miroir · Espelho	485
Carriots et bidon · Carrinhos e bidão	486
Comptoir de réception et d'autres	487
Mostrador de recepção e outros	

08 Accessoires Acessórios 490

Papler de cou · Papel pescoço	491
Capas · Capas	493
Vêtement homme LACLA	498
Vestuário de homem LACLA	
Pulvérisateur · Pulverizador	502
Valises · Maletas	506
Serviettes · Toalhas	508
Gants et accessoires · Luvas e acessórios	510
Désinfectant et stérilisateur, miroirs et balais	513
Desinfetante e esterilizador, espelhos e vassouras	

09 Formation Formação 520

Têtes malléables BERGMANN	521
Cabeças manequim BERGMANN	
Têtes malléables BARBER LINE, EUROSTIL	522
Cabeças manequim BARBER LINE, EUROSTIL	
Supports et trépied · Soportes e tripé	523

Les prix indiqués dans ce catalogue sont des prix recommandés, taxes en sus.
Les prix seront valables sauf erreurs typographiques.
Industrias Oriol 1942, S.L. se réserve le droit d'apporter des modifications sans préavis.

*Os preços listados neste catálogo são preços recomendados, impostos não incluídos.
Os preços serão válidos, exceto por erros tipográficos.
Industrias Oriol 1942, S.L. reserva-se o direito de fazer modificações sem aviso prévio.*

01

Appareils électriques

EQUIPAMENTOS

*Tondeuses, rasoirs, séchoirs,
tondeuse nez, chauffe-cires...*

*Máquinas de corte, máquinas de barbear,
secadores, máquina nariz, pranchas ...*



Tondeuse à cheveux GALAXY FADING

Máquina de cortar cabelo GALAXY FADING



REF. 07220



NEW

» Spécial FADE
» Especial FADE

- » Prêt pour la décoloration
- » Sans levier de réglage de la lame
- » Lame fixe réglable de 0,2 à 0,3
- » Tension : 100-240 V~.
- » Fréquence : 50/60 Hz.
- » Puissance : 8 W
- » 5 500 tr/min (+/-100)
- » Degré dégradation : 0,2- 0,3 mm
- » Lame en Acier Japonais.
- » Lame fixe en Titane.
- » Brosse de nettoyage.
- » Flacon d'huile lubrifiante.
- » Protection de lame.
- » Source d'alimentation.
- » Écran LCD multifonction.

- » Pronto para desaparecer
- » Sem alavanca reguladora de lâmina
- » Lâmina fixa ajustável para 0,2 - 0,3
- » Voltagem: 100-240V~
- » Frequência: 50/60Hz.
- » Potência: 8W
- » 5500 r.p.m. (+/-100)
- » Grau de degradação: 0,2 - 0,3 mm
- » Lâmina de Aço Japonês.
- » Lâmina fixa de Titânio.
- » Escova de limpeza.
- » Frasco de óleo lubrificante.
- » Protetor lâmina.
- » Fonte de alimentação.
- » Ecrã LCD multifunções.



Lame · Lâmina



REF.07389



Tondeuse à cheveux GALAXY CERAMIC

Máquina de cortar cabelo GALAXY CERAMIC



REF. 07221



NEW

» LAME EN CÉRAMIQUE: réduit l'échauffement de la lame
» LÂMINA DE CERÂMICA: reduz o aquecimento da lâmina

- » Tension : 100-240 V~.
- » Fréquence : 50/60 Hz.
- » Puissance : 8 W
- » 5 500 tr/min (+/-100)
- » Degré dégradation : 0,5 mm
- » Levier de réglage de la lame.
- » LAME EN CÉRAMIQUE et lame fixe en titane.
- » 6 sabots (1,5, 3, 4,5, 6, 10 et 13 mm).
- » Brosse de nettoyage.
- » Flacon d'huile lubrifiante.
- » Protection de lame.
- » Source d'alimentation.
- » Écran LCD multifonction.
- » Lame céramique

- » Voltagem: 100-240V~
- » Frequência: 50/60Hz.
- » Potência: 8W
- » 5500 r.p.m. (+/-100)
- » Grau de degradação: 0,5mm
- » Alavanca reguladora de lâmina.
- » LÂMINA DE CERÂMICA e lâmina fixa de titânio.
- » 6 pentes adaptadores de medida (1,5, 3, 4,5, 6, 10 e 13 mm).
- » Escova de limpeza.
- » Frasco de óleo lubrificante.
- » Protetor lâmina.
- » Fonte de alimentação.
- » Ecrã LCD multifunções.
- » Lâmina de cerâmica.



» Idéal pour travailler de longues heures
» Ideal para trabalhar longas horas



Lame · Lâmina



REF.07388



Tondeuse GALAXY
Máquina de corte GALAXY

REF. 06714



REF. 06714/50



Pièces de rechange
Recargas

Peignes · Pentes

1,5 mm REF. RE06985/01



3 mm REF. RE06985/02



4,5 mm REF. RE06985/03



6 mm REF. RE06985/04



10 mm REF. RE06985/05



13 mm REF. RE06985/06



Lame · Lâmina

» Plat REF. 06983
» Plano



» Standard REF. 06984
» Padrão



» Pack 6 peignes métalliques REF. 06985
» Pack 6 pentes metálicos



- » Levier réglage de la lame
- » Lames en acier japonais
- » 6 sabots accessoires longueurs de coupe 1.5, 3, 4.5, 6, 10, 12 mm
- » Brosse de nettoyage
- » Flacon huile lubrifiante
- » Protection lame
- » Source d'alimentation
- » Écran LCD multifonction
- » Puissance maximale: 8 W
- » Tension : 100-240 V~
- » Fréquence : 50/60 Hz
- » Tours par minute : 5500+/-800 tr/min
- » Degré dégradation : 0,5 mm

- » Alavanca reguladora de lâmina
- » Lâmina de aço japonês.
- » 6 pentes (1.5, 3, 4.5, 6, 10 e 13 mm)
- » Escova de limpeza
- » Frasco de óleo lubrificante
- » Protetor lâmina
- » Fonte de alimentação
- » Visor LCD multifunção
- » Potência máxima: 8W
- » Voltagem: 100-240V~
- » Frequência: 50/60Hz
- » Revoluções por minuto: 5500+/-100 rpm
- » Grau de degradação: 0,5mm

Pièces de rechange
Recargas

Peignes · Pentas	
1,5 mm	REF. RE06985/01
3 mm	REF. RE06985/02
4,5 mm	REF. RE06985/03
6 mm	REF. RE06985/04
10 mm	REF. RE06985/05
13 mm	REF. RE06985/06

Lame · Lâmina	
» Plat » Plano	REF. 06983
» Standard » Padrão	REF. 06984
» Pack 6 peignes métalliques » Pack 6 pentas metálicos	REF. 06985

Tondeuse SUPERNOVA
Máquina de corte SUPERNOVA

REF. 06715

REF. 06715/50



- » Levier réglage de la lame
- » Lame en acier japonais
- » 6 sabots accessoires longueurs de coupe 1,5, 3, 4,5, 6, 10, 13 mm
- » Brosse de nettoyage
- » Flacon huile lubrifiante
- » Protection lame
- » Source d'alimentation
- » Fonction turbo
- » Écran LCD multifonction
- » Puissance maximale : 8 W
- » Tension : 100-240 V~
- » Fréquence : 50/60 Hz
- » Tours par minute : 5500+/-100 tr/min
- » Turbo : 5700+/-100 tr/min
- » Degré dégradation : 0,5 mm

- » Alavanca reguladora de lâmina
- » Lâmina de aço japonês.
- » 6 pentas (1,5, 3, 4,5, 6, 10, 13 mm)
- » Escova de limpeza
- » Frasco de óleo lubrificante
- » Protetor lâmina
- » Fonte de alimentação
- » Função turbo
- » Visor LCD multifunção
- » Potência máxima: 8W
- » Voltagem: 100-240V~
- » Frequência: 50/60Hz
- » Revoluções por minuto: 5500+/-100 rpm
- » Turbo: 5700/-100 rpm
- » Grau degradação: 0,5mm

Tondeuses à cheveux BLACK SAM
Máquinas de corte BLACK SAM



REF. 06334

Pièces de rechange
Recargas

Peignes · Pentes

1,5 mm REF. RE06454/01



3 mm REF. RE06454/02



4,5 mm REF. RE06454/03



6 mm REF. RE06454/04



9 mm REF. RE06454/05



12 mm REF. RE06454/06



» Pack 6 peignes métalliques
» Pack 6 pentes metálicos



REF. 06454

Lame · Lâmina

» Standard REF. 06457
» Padrão



» Plat REF. 06458
» Plano



- » Sans cable
- » Comprend 6 peignes en métal et 2 lames
- » Avec des lames en acier japonais
- » Tension: 100-240V~
- » Fréquence: 50TT/60Hz
- » Puissance maximale: 5W
- » Tours par minute: 5500 +/- 800 rpm
- » Entrée adaptateur: 0,2 A
- » Adaptateur de sortie: 5V ~600mA
- » Convient à tout type de cheveux naturels
- » Degré dégradation : 0,5 mm

- » Sem cabo
- » Inclui 6 pentes de metal e 2 lâminas
- » Com lâminas de aço japonesas
- » Voltagem: 100-240V ~
- » Frequência: 50 / 60Hz
- » Potência máxima: 5W
- » Revoluções por minuto: 5500 +/- 800 rpm
- » Entrada do adaptador: 0,2 A
- » Adaptador de saída: 5V 600mA
- » Adequado para qualquer cabelo natural
- » Grau degradação: 0,5mm





Pièces de rechange Recargas

Peignes · Pentas		
1,5 mm		REF. RE06602/01
3 mm		REF. RE06602/02
4,5 mm		REF. RE06602/03
6 mm		REF. RE06602/04
9 mm		REF. RE06602/05
12 mm		REF. RE06602/06
» Pack 6 peignes métalliques » Pack 6 pentas metálicos		REF. 06602

Lame · Lâmina

» Standard » Padrão	REF. 07327	REF. 06603
NEW		
» Plat » Plano	REF. 07326	REF. 06604
NEW		

Tondeuse cheveux eagle avec cable Máquinas de corte eagle com cabo



REF. 06390

- » Avec cable 2,5 m
- » Comprend 6 peignes en métal et 2 lames
- » Avec des lames en acier japonais
- » Tension: 220-240V~
- » Fréquence: 50 Hz
- » Puissance maximale: 10W
- » Tours par minute: 6500+/-800 rpm
- » Convient à tout type de cheveux naturels
- » Degré dégradation : 0,5 mm

- » Com cabo 2,5 m
- » Inclui 6 pentas de metal e 2 lâminas
- » Com lâminas de aço japonesas
- » Tensão: 220-240V ~
- » Frequência: 50 Hz
- » Potência máxima: 10W
- » Revoluções por minuto: 6500 +/- 800 rpm
- » Adequado para qualquer tipo de cabelo natural
- » Grau de degradação: 0,5mm



Tondeuse cheveux FALCON sans cable Máquinas de corte FALCON sem cabo



REF. 06391

- » Sans cable
- » Comprend 6 peignes en métal et 2 lames
- » Avec des lames en acier japonais
- » Tension: 100-240V~
- » Fréquence: 50/60Hz
- » Puissance maximale: 5W
- » Tours par minute: 5500+/-800 rpm
- » Entrée adaptateur: 0,2 A
- » Adaptateur de sortie: 5V 600mA
- » Convient à tout type de cheveux naturels
- » Degré dégradation : 0,5 mm

- » Sem cabo
- » Inclui 6 pentas de metal e 2 lâminas
- » Com lâminas de aço japonesas
- » Voltagem: 100-240V ~
- » Frequência: 50 / 60Hz
- » Potência máxima: 5W
- » Revoluções por minuto: 5500+/-800 rpm
- » Entrada do adaptador: 0.2 A
- » Adaptador de saída: 5V 600mA
- » Adequado para qualquer tipo de cabelo natural
- » Grau de degradação: 0,5mm



Tondeuse cheveux k-3600
Máquinas de corte k-3600



Pièces de rechange
Recargas



Tête · Cabeça

REF. RE03752/01



Peignes · Pentes

3 mm REF. RE03752/07



6 mm REF. RE03752/08



9 mm REF. RE03752/09



12 mm REF. RE03752/10



Batterie · Bateria

REF. RE03752/03



REF. 03752



REF. 03752/50



Temps de travail
De 60 / 90 min
Tempo de
operação
60 / 90 Min



La batterie ou le courant électrique peuvent être utilisés
Pode usar-se com Bateria ou ligado à eletricidade



5h de charge
5h de carga



Tête de coupe en Céramique et lame en titane
Cabeça de cerâmica e lâmina de titânio

- » Puissance: 5W
- » Tension: 200-240V ~
- » Fréquence 50Hz
- » Adaptateur de sortie: 3V ~ 500mA
- » Accessoires: 4 peignes
- » Tête de coupe en céramique à mouvement réglable dans une mesure de coupe
- » Lame fixe en titane
- » Cable d'alimentation
- » 2 piles rechargeables
- » Brosse de nettoyage
- » Burette d'huile de lubrification

- » Potência: 5W
- » Tensão: 200-240V ~
- » Frequência 50Hz
- » Adaptador de saída: 3V ~ 500mA
- » Acessórios: 4 pentes
- » Cabeça de corte em cerâmica com movimento regulável. Lâmina fixa de titânio
- » Cabo de alimentação
- » 2 baterias recarregáveis
- » Escova de limpeza
- » Frasco de óleo lubrificante



Pièces de rechange
Recargas**Tête · Cabeça**

8 mm

REF. RE03753/06



30 mm

REF. RE03753/04



40 mm

REF. RE03753/05

» Tête pour le nez REF. RE03753/07
» Cabeça nariz» Tête pour rasée REF. RE03753/08
» Cabeça barbeado**Peigne · Pente**

REF. RE03753/01

**Tondeuse cheveux K-3000**
Máquinas de corte K-3000

Machine à couper les cheveux professionnelle pour les retouches sur la barbe, le nez et les oreilles

Máquina de corte de cabelo profissional para retoques na barba, nariz e orelhas



REF. 03753

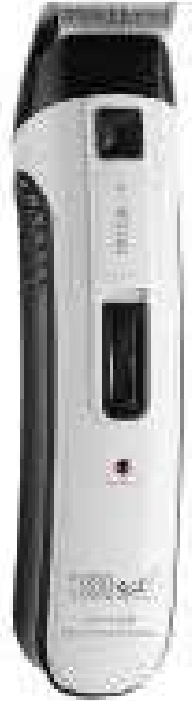

- » Puissance: 3W
- » Lames de 30 mm, 40 mm, 8 mm pour dessiner des motifs, nez / oreilles et tête de rasage
- » Lame interchangeable facile à nettoyer
- » Faible vibration et très silencieuse
- » LED Indiquant la charge
- » Charge à long terme, jusqu'à 60 minutes d'autonomie
- » Longueur de coupe réglable 4 niveaux : 3 mm, 6 mm, 9 mm et 12 mm

- » Potência: 3W
- » Lâminas de 30 mm, 40 mm, 8 mm para detalhes, cabeça, nariz / orelhas
- » Lâmina fácil de mudar e limpar
- » Baixa vibração e muito silenciosa
- » LED indicador de carga
- » Carga de longa duração, até 60 minutos de autonomia
- » Longitude ajustável de corte 4 níveis: 3 mm, 6 mm, 9 mm e 12 mm

Tondeuse de finition COSMIC
Máquina corte COSMIC touch-up



REF. 06713

REF. 06713/50



Pièces de rechange
Recargas

Peignes · Pentes

2 mm



REF. RE06713/01

3 mm



REF. RE06713/02

4 mm



REF. RE06713/03

Lame de coupe T-zero
Lâmina aparadora T-zero



REF.06982

- » Tête de coupe de 38 mm
- » Lame fixe en acier oxydable
- » Sabot adaptateur longueurs de coupe 2,3 et 4 mm
- » Brosse de nettoyage
- » Flacon huile lubrifiante
- » Câble d'alimentation
- » Bouton marche/arrêt
- » Écran LCD multifonction
- » Puissance maximale : 5 W
- » Tension : 100-240 V~
- » Fréquence : 50/60 Hz
- » Tours par minute : 5500+/-100 tr/min

- » Cabeça 38 mm
- » Lâmina fixa de aço inoxidável
- » Adaptador pentes (2, 3 and 4 mm)
- » Escova de limpeza
- » Frasco de óleo lubrificante
- » Cabo de alimentação
- » Botão on/off
- » Visor LCD
- » Potência máxima: 5W
- » Voltagem: 100-240V~
- » Frequência: 50/60Hz
- » Revoluções por minuto: 5500+/-100 rpm

**Tondeuse TRIUMPH**
Máquina de corte TRIUMPH

REF. 06667

Peignes · Pentes

NEW



1 mm

REF. RE06667/05



2 mm

REF. RE06667/06



3 mm

REF. RE06667/07

» Avec vis réglables
» Com parafusos ajustáveis

REF. RE06667/01



- » Sans cable
- » Tête de coupe de 38 mm
- » Lame fixe en acier oxydable
- » Sabot accessoire longueurs de coupe 1,2 et 3 mm
- » Brosse de nettoyage
- » Flacon huile lubrifiante
- » Câble d'alimentation
- » **CHARGEUR**
- » Bouton marche/arrêt
- » Puissance maximale : 10 W
- » Tension : 100-240 V~
- » Fréquence : 50/60 Hz
- » Tours par minute : 5500+/-800 tr/min.
- » Degré dégradation : 0,1 mm

- » Sem cabo
- » Cabeça de corte de 38 mm
- » Lâmina fixa de aço inoxidável
- » Pente adaptador para medida de corte (1,2 e 3 mm)
- » Escova de limpeza
- » Frasco de óleo lubrificante
- » Cabo de alimentação
- » **BASE DE CARREGAMENTO**
- » Botão de ON/OFF
- » Potência máxima: 10W
- » Voltagem: 100-240V~
- » Frequência: 50/60Hz
- » Revoluções por minuto: 5500+/-800 rpm
- » Grau de degradação: 0,1mm



**01**

APPAREILS ÉLECTRIQUES · EQUIPAMENTOS

Tondeuse et retouch CAPTAIN COOK · Máquinas de retoque CAPTAIN COOK

Tondeuse THUNDER
Máquina de corte THUNDER

REF. 06666

Pièces de rechange
Recargas**Peignes · Pentes**

1,5 mm REF. RE06602/01



3 mm REF. RE06602/02



4,5 mm REF. RE06602/03



6 mm REF. RE06602/04



9 mm REF. RE06602/05



12 mm REF. RE06602/06

» Pack 6 peignes métalliques REF. 06602
» Pack 6 pentes metálicos**Lame · Lâmina**» Standard REF. 07327 REF. 06603
» Padrão» Plat REF. 07326 REF. 06604
» Plano

- » Levier réglage de la lame
- » 2 lames en acier japonais
- » 6 sabots accessoires longueurs de coupe 1.5, 3, 4.5, 6, 10, 12 mm
- » Brosse de nettoyage
- » Flacon huile lubrifiante
- » Protection lame
- » Puissance maximale : 10 W
- » Tension : 100-240 V~
- » Fréquence : 50/60 Hz
- » Tours par minute : 5500+/-800 tr/min
- » Degré dégradation : 0,5 mm
- » **SUPPORT DE CHARGE**

- » Alavanca reguladora de lâmina
- » 2 lâminas de aço japonês
- » 6 pentes adaptadores de medida (1.5, 3, 4.5, 6, 10, 12 mm)
- » Escova de limpeza
- » Frasco de óleo lubrificante
- » Protetor lâmina
- » Potência máxima: 10W
- » Voltagem: 100-240V~
- » Frequência: 50/60Hz
- » Revoluções por minuto: 5500+/-800 rpm
- » Tours par minute : 5500+/-800 tr/min
- » Grau de degradação: 0,5mm
- » **BASE DE CARREGAMENTO**



**Pack n°1 « 5ème anniversaire » CAPTAIN COOK**
Pack n.º1 "5º Aniversário" CAPTAIN COOK

REF. 07276

**NEW**

Contient:

- » Brosse Fade - 04977
- » Ciseaux sculpteurs Black ripper 6" - 06479
- » Tondeuse Thunder - 06666
- » Trousse Captain Cook - 07079

Contém:

- » Escova Fade - 04977
- » Tesoura black ripper esculpir 6" - 06479
- » Máquina de corte Thunder - 06666
- » Nécessaire Captain Cook - 07079

Pack n°2 « 5ème anniversaire » CAPTAIN COOK
Pack n.º2 "5º Aniversário" CAPTAIN COOK

REF. 07330

**NEW**

Contient:

- » Tondeuse Thiumph - 06667
- » Brosse Fade - 04977
- » Ciseaux sculpteurs 6" Black ripper - 06479
- » Trousse Captain Cook - 07079

Contém:

- » Máquina de corte Thiumph - 06667
- » Escova Fade - 04977
- » Tesoura esculpir 6" Black ripper - 06479
- » Nécessaire Captain Cook - 07079

Tondeuse à retouche AIRFLIP
Máquina retoque AIRFLIP



REF. 07282

Pièces de rechange
Recargas



Vision coupe de la lame
Visão corte de lâmina

NEW

Peignes · Pentes

NEW



1 mm

REF. RE0782/01



2 mm

REF. RE0782/02



3 mm

REF. RE0782/03



Lame · Lâmina

REF.07324



- » Tension : 100-240 V~
- » Fréquence : 50/60 Hz.
- » Puissance : 8 W
- » 6 500 tr/min (+/-500)
- » Tête de coupe de 38 mm
- » Protection de lame
- » Lame fixe en Acier Inoxydable
- » Sabot adaptateur pour coupe à 1, 2 et 3 mm
- » Brosse de nettoyage.
- » Flacon d'huile lubrifiante
- » Câble d'alimentation
- » **SUPPORT DE CHARGE**
- » Couvercle transparent
- » Degré dégradation : 0,1 mm

- » Voltagem: 100-240V~
- » Frequência: 50/60Hz.
- » Potência: 8W
- » 6500 r.p.m. (+/-500)
- » Cabeça de corte de 38 mm
- » Protetor lâmina
- » Lâmina fixa de aço inoxidável
- » Pente adaptador para medida de corte (1,2 e 3 mm)
- » Escova de limpeza.
- » Frasco de óleo lubrificante
- » Cabo de alimentação
- » **BASE DE CARREGAMENTO**
- » Tampa transparente
- » Grau degradação: 0,1mm



Tondeuse à retouche DRAKE

Máquina retouque DRAKE



REF. 07283



Vision coupe de la lame
Visão corte de lâmina

Pièces de rechange

Recargas

Lame · Lâmina

REF.07325



NEW



- » Tension : 100-240 V~.
- » Fréquence : 50/60 Hz.
- » Puissance : 8 W
- » 7000+/-500 tr/min.
- » Tête de coupe de 38 mm.
- » Lame fixe en Acier Inoxydable.
- » Sabot adaptateur pour coupe à 1, 2 et 3 mm.
- » Brosse de nettoyage.
- » Flacon d'huile lubrifiante.
- » Câble d'alimentation.
- » Couvercle transparent.
- » Degré dégradation : 0,1 mm

- » Voltagem: 100-240V~
- » Frequência: 50/60Hz.
- » Potência: 8W
- » 7000+/-500 rpm.
- » Cabeça de corte de 38 mm.
- » Lâmina fixa de aço inoxidável.
- » Pente adaptador para medida de corte (1,2 e 3 mm).
- » Escova de limpeza.
- » Frasco de óleo lubrificante.
- » Cabo de alimentação.
- » Tampa transparente.
- » Grau degradação: 0,1mm



Tondeuse COMET
Navalha COMET



Merci d'avoir choisi notre nouvelle tondeuse COMET 07084/50-07084/54, rechargeable, de « RAGNAR », conçues pour un usage professionnel. Moteurs puissants et endurants, très silencieux et de faible vibration. Fabriquées avec des matériaux de haute qualité et de dernière génération.

Obrigado por ter escolhido a nossa nova navalha COMET 07084/50-07084/54 recarregável de "RAGNAR", concebidas para uso profissional. Os seus potentes motores de longa duração são supersilenciosos e de baixa vibração. Os mesmos foram fabricados com materiais de alta qualidade e de última geração.



REF. 07084/50



REF. 07084/54



- » Voltage : 100-240 V~
- » Fréquence : 50/60 Hz
- » Entrée adaptateur : 0,2 A
- » Sortie adaptateur : 5V 1000mA
- » Révolutions par minute : 8.000-9.000 rpm
- » Puissance maximale : 5 W
- » Temps de charge : 3 heures
- » Temps en fonctionnement : plus de 80 minutes
- » Batterie lithium
- » Apte pour tout type de poils naturels
- » Conditions environnementales idéales pour son utilisation: utilisation en intérieur
- » Température de -5° à 40°C
- » Humidité relative égale ou inférieure à 80%

- » Voltagem: 100-240V~
- » Frequência: 50/60Hz
- » Potência máxima: 5W
- » Revoluções por minuto: 8.000-9.000 rpm
- » Entrada adaptador: 0,2 A
- » Saída adaptador: 5V 1000mA
- » Tempo de carregamento: 3 horas
- » Tempo de funcionamento: mais de 80 minutos
- » Pilha de lítio
- » Apta para qualquer tipo de cabelo natural
- » Condições ambientais ideais para a sua utilização: utilização em interiores
- » Temperatura -5° a 40°C
- » Humidade relativa igual ou menor a 80%

Pièces de rechange
Recargas

Tête complète avec lame
Cabeça completa com lâmina

- » Noir
- » Preta



REF. RE07084/50/01



- » Gris
- » Cinza



REF. RE07084/54/01



Tondeuse BUCANERO**Navalha BUCANERO**

Merci d'avoir choisi notre nouvelle tondeuse BUCANERO 06412 rechargeable "Barber Line", conçue pour un usage professionnel. Moteur puissant et durable, très silencieux et peu vibrant. Fabriqué avec des matériaux de haute qualité et de dernière génération.

Obrigado por escolher nossa nova navalha BUCANERO 06412 "Barber Line", projetada para uso profissional. Motor potente e duradouro, super silencioso e com baixa vibração. Fabricado com alta qualidade e materiais de última geração.



» Noir
» Preto

REF. 06412/50



- » Voltage : 100-220V~
- » Fréquence: 50/60Hz
- » Puissance: 3W
- » Révolutions par minute: 6800 rpm
- » Entrée adaptateur: 3-5 W
- » Sortie adaptateur : 2 W.
- » Temps de charge: 2 heures
- » Temps en fonctionnement : plus de 90 minutes
- » Batterie lithium
- » Apte pour tout type de poils naturels

- » Frequência: 50/60Hz
- » Potência: 3W
- » Revoluções por minuto: 6800 rpm
- » Entrada adaptador: 3-5 W
- » Saída adaptador: 2 W
- » Tempo de carregamento: 2 horas
- » Tempo de funcionamento: mais de 90 minutos
- » Bateria de lítio
- » Apta para qualquer tipo de cabelo natural

Pièces de rechange
Recargas

Tête complète avec lame
Cabeça completacom lâmina



» Gris
» Cinza



REF. RE06412/01

» Noir
» Preto



REF. RE06412/50/01



Tondeuses ROADSTER

Máquinas de barbear ROADSTER



Nous vous remercions d'avoir choisi notre tondeuse rechargeable ROADSTER 06411 de «Captain Cook», conçu pour un usage professionnel. Moteur puissant et durable, très silencieux et peu vibrant. Fabriqué avec des matériaux de haute qualité et de dernière génération.

Obrigado por escolher nosso novo Barbeador Recarregável ROADSTER 06411 da "Captain Cook", projetado para uso profissional. Motor potente e duradouro, super silencioso e com baixa vibração. Fabricado com alta qualidade e materiais de última geração.

REF. 06411



- » Fréquence: 50/60Hz
- » Puissance: 3W
- » Révolutions par minute: 6800 rpm
- » Entrée adaptateur: 3-5 W
- » Sortie adaptateur : 2 W
- » Temps de charge: 2 heures
- » Temps en fonctionnement : plus de 90 minutes
- » Batterie lithium
- » Apte pour tout type de poils naturels

- » Frequência: 50/60Hz
- » Potência: 3W
- » Revoluções por minuto: 6800 rpm
- » Entrada adaptador: 3-5 W
- » Saída adaptador: 2 W
- » Tempo de carregamento: 2 horas
- » Tempo de funcionamento: mais de 90 minutos
- » Bateria de lítio
- » Apta para qualquer tipo de cabelo natural

Pièces de rechange

Recargas

Tête complète avec lame

Cabeça completacom lâmina



REF. RE06411/01

Tondeuse nez EUROSTIL
Máquina nariz EUROSTILBatterie non incluse
Bateria não incluída

- » Elle peut être mouillée
- » Avec la base et 2 accessoires.

REF. 04268

- » Elle ne peut pas être mouillée
- » Não pode se molhar

REF. 04269

- » Pode molhar-se
- » Com base e 2 acessórios

**Tondeuse-stylo de retouche**
Máquina corporalBatterie non incluse
Bateria não incluída

- » Conception ergonomique
- » Respectueuse avec la peau sensible
- » Interrupteur marche / arrêt
- » 2 niveaux de coupe: pour 2 mm de long / pour 5 mm de long
- » Housse de protection
- » Tête d'angle pour une utilisation facile
- » Alimentation
- » 1 pile AAA (non incluse)

- » Design Ergonómico
- » Suave com a pele sensível
- » Botão con/off
- » 2 Níveis de corte: para 2 mm de comprimento / para 5 mm de comprimento
- » Tampa protetora
- » Cabeça em ângulo para facilitar a sua utilização
- » Fonte de alimentação
- » 1 Pilha AAA (Não incluída)



REF. 04270

Huiles 500 ML

Óleos 500 ML



Huile pour tondeuses à usage professionnel. Réfrigérant, désinfectant, lubrifiant et antioxydante, ce qui la rend indispensable pour un entretien optimum des lames. Pulvériser à une distance d'environ 15-20 cm de la partie supérieure et latérale de la tête de la machine.

Óleo para máquinas de utilização profissional. Refrigerante, higienizante, lubrificante e antioxidante o que o torna imprescindível para uma manutenção ótima das lâminas. Pulverize a uma distância de 15-20 cm, aproximadamente, da parte superior e lateral da cabeça da máquina.

» Parfum intense
» Perfume intenso



500 ml

REF. 06272



» Parfum doux
» Perfume suave



500 ml

REF. 06395



Bouteille d'huile

Garrafa de óleo



Cette huile spécialement conçue pour les tondeuses à cheveux de la marque Eurostil est une huile minérale légère qui améliore le temps de levage de la lame améliorant ainsi sa coupe. Non irritante.

Este óleo especial para máquinas de cortar da marca Eurostil é um óleo mineral leve que melhora o tempo de elevação da folha melhorando assim o corte da mesma. Não irrita.

» Lubrifiante
» Lubrificante



100 ml

REF. 03751

Présentoir CLIPP-AID

Expositor CLIPP-AID

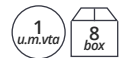

» Uniquement pour les lames en acier

» Só para lâminas de aço



REF. 04573

Contient 18 sachets
x ref. (04571 et
04572)

18 saquetas x ref.
(04571 e 04572)

Tapis barbier RAGNAR
Tapete de barbeiro RAGNAR

» Matériel: caoutchouc
» Material: borracha

1
u.m.vta

12
box

REF. 07386

**Tapis barbier CAPTAIN COOK**
Tapete de barbeiro CAPTAIN COOK

» Matériel: caoutchouc
» Material: borracha

1
u.m.vta

12
box

REF. 07387



Sèche-cheveux compact professionnel

Secador compact professional



Le sèche-cheveux compact professionnel a un design attrayant, ergonomique et léger. Disponible en noir et en blanc. Doté d'une finition en caoutchouc colorée pour l'empêcher de glisser. Moteur puissant avec générateur d'ions. Comprend deux buses de tailles différentes.

O Secador Compact Professional tem um design atrativo, ergonômico e leve. Disponível cor preto, branco e branco com borrachas coloridas. Motor potente, com gerador de iões. Inclui dois bocais de diferentes dimensões.

REF. 04202



21,5 cm



- » Puissance: 2000W
- » Moteur à courant alternatif (AC) compact de longue durée
- » Poids: 580 g
- » Débit d'air: 90 m³/heure
- » 2 vitesses · 3 températures
- » Bouton d'air froid
- » 2 buses réglables de 62mm et 70mm
- » Filtre amovible
- » Thermostat de sécurité
- » Câble souple de 3m avec anneau de suspension.
- » Tension 220-240V~
- » Fréquence: 50/60 Hz
- » Faible niveau sonore (70db)
- » Design ergonomique
- » Boîtier robuste et léger en polyamide
- » Finition en caoutchouc antidérapant
- » Moteur générateur d'ions

- » Potência: 2000W
- » Motor compacto de longa duração (AC)
- » Peso: 580 gr
- » Fluxo de ar: 90m³ / hora
- » 2 velocidades · 3 temperaturas
- » Botão de ar frio
- » 2 bocais direcionáveis de 62mm e de 70mm
- » Filtro extraível
- » Termóstato de segurança
- » Cabo flexível de 3m com aro para pendurar.
- » Voltagem 220-240V ~
- » Frequência: 50/60 Hz
- » Baixo nível sonoro (70db)
- » Design ergonômico
- » Exterior robusto e leve em Poliamida
- » Capa de borracha antiderrapante
- » Motor gerador de íon

Sèche-cheveux compact ultra light
Secador compact extra light



Le sèche-cheveux compact professionnel a un design attrayant, ergonomique et léger. Disponible en noir et en blanc. Doté d'une finition en caoutchouc colorée pour l'empêcher de glisser. Moteur puissant avec générateur d'ions. Comprend deux buses de tailles différentes.

O Secador Compact Professional tem um design atrativo, ergonómico e leve. Disponível cor preto, branco e branco com borrachas coloridas. Motor potente, com gerador de iões. Inclui dois bocais de diferentes dimensões.

REF. 04203

REF. 04203/58



21,5 cm



21,5 cm



- » Puissance: 1800W
- » Moteur à courant alternatif (DC) compact de longue durée
- » Poids: 430 g
- » Débit d'air: 76 m³/heure
- » 2 vitesses · 3 températures
- » Bouton d'air froid
- » 2 buses réglables de 62mm et 70mm
- » Filtre amovible
- » Thermostat de sécurité
- » Câble souple de 3m avec anneau de suspension
- » Tension 220-240V~
- » Fréquence: 50/60 Hz.
- » Compact et PLUS LÉGER
- » Finition en caoutchouc antidérapant
- » Faible niveau sonore
- » Moteur générateur d'ions

- » Potência: 2000W
- » DC motor
- » Peso: 430 gr
- » Fluxo de ar: 90m³ / hora
- » 2 velocidades · 3 temperaturas
- » Botão de ar frio
- » 2 bocais direcionáveis de 62mm e de 70mm
- » Filtro extraível
- » Termóstato de segurança
- » Cabo flexível de 3m com aro para pendurar.
- » Voltagem 220-240V ~
- » Frequência: 50/60 Hz
- » Compacto e mais leve
- » Baixo nível sonoro
- » Motor gerador de íon

Sèche-cheveux robust barber line
Secador robust barber line



Conçu comme le complément idéal pour le coiffeur, le nouveau sèche-cheveux ROBUST d'Barber Line apporte un haut débit d'air, un plus grand rendement et une diminution du temps de séchage. Il permet de réaliser tout type de coiffure: lissage, cheveux bouclés, augmentation du volume, etc. Vos cheveux seront plus doux, plus brillants et pleins de vie.

Realizado como complemento ideal para o cabeleireiro. O novo secador de cabelo ROBUST de Barber Line oferece um grande fluxo de ar, um aumento do rendimento e a redução do tempo de secagem. Permite criar qualquer tipo de penteado: lisos, ondulados, volume etc. Cabelo estará suave, brilhante e saudável.

- » Puissance: 1900W - 2200W
- » Tension: 220-240V~
- » Fréquence: 50/60 Hz

REF. 06475

- » Potência: 1900W - 2000W
- » Voltagem: 220-240V ~
- » Frequência: 50/60 Hz



19 cm



Styling / Photographie: Pugilato · Styling / Fotografia: Pugilato

Chauffe-cire noir barber line 125 ml Panela de cera preto barber line 125 ml



REF.04505

- » Chauffe-cire compact
- » Surface antiadhésive, facile à nettoyer
- » Température réglable
- » Chauffe rapide
- » Couvercle de protection
- » Capacité: 125 ml
- » Tension: 220-240V~
- » Puissance: 40W
- » Fréquence: 50 Hz
- » Température maximale 90°C

- » *Panela de cera compacto*
- » *Superfície antiaderente para facilitar a limpeza*
- » *Ajustes de temperatura variável*
- » *Aquecimento rápido*
- » *Capa protetora*
- » *Capacidade: 125 ml*
- » *Voltagem: 220 - 240 V~*
- » *Frequência: 50Hz*
- » *Potência: 40W*
- » *Temperatura máxima 90°C*



Fer à lisseur petit barber line pour barbe et frange Prancha pequena, barber line para barba e franja

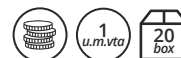

Les nouveaux fers à lisseur Mini Barber Line permettent de créer tout type de coiffure ondulée, lisse etc. Utilisation professionnelle.
As novas pranchas Mini Barber Line permitem criar qualquer tipo de penteado ondulado, liso, etc. Utilização profissional.

REF. 06569/50

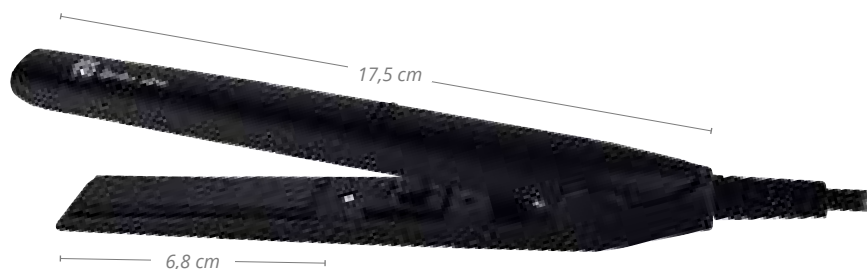

- » Fer à cheveux en céramique et tourmaline qui prend soin des cheveux et leur apporte brillance et douceur
- » Tension: 100 - 240 V ~
- » Fréquence : 50/60 Hz
- » Puissance 22 W
- » Câble en caoutchouc de 2 m
- » Échauffement des plaques en seulement 30 secondes, avec une résistance de type PTC
- » Température maximale 200°C
- » Résistance PTC qui évite les surchauffes
- » Apte pour tout type de cheveux naturels
- » NE PAS UTILISER SUR LES CHEVEUX SYNTHÉTIQUES
- » NE PAS UTILISER SUR LES CHEVEUX MOUILLÉS

- » *Placas de Cerâmica com Turmalina que cuidam do cabelo proporcionando brilho e suavidade*
- » *Tensão: 100-240 V~*
- » *Frequência: 50/60 Hz*
- » *Potência 22 W*
- » *Cabo de borracha*
- » *Aquecimento de placas em apenas 30 segundos, com resistência PTC*
- » *Temperatura máxima 200°C*
- » *Resistência PTC que evita o sobreaquecimento*
- » *Adequada para qualquer tipo de cabelo natural*
- » **NÃO USAR EM CABELO SINTÉTICO**
- » **NÃO ADEQUADA PARA CABELO MOLHADO**



Aspirateur Aspirador de pó



aspirateur à cheveux de dernière technologie, conçu pour faciliter le processus de travail professionnel.

Deux positions opérationnelles:

1. MODE MANUEL: consiste en un bouton d'activation manuelle d'une durée de 5 secondes. Il permet d'éliminer les débris en les rapprochant de la base de l'unité à l'aide du bouton d'activation manuelle, qui devra être activé plusieurs fois en fonction de la quantité et du type de déchets générés.

2. MODE AUTO: grâce à la puissance de ses capteurs situés à la base de l'unité, il permet de détecter et d'éliminer les débris générés facilitant le travail du professionnel. Automatiquement, il démarre un cycle d'aspiration, qui se terminera une fois que les capteurs ne détecteront plus de débris.

Aspirador de Cabelo última tecnologia. No modo manual, varre os escombros para a entrada na base da unidade, pressopne o botão de ativação manual e deixe que o HAIR VACUUM aspire cabelos/pelos através da entrada da base.

1. O modo MANUAL terá uma duração de 5 segundos. Dependendo da quantidade de resíduos, pode ser necessário pressionar o botão de ativação manual mais de uma vez.

2. Quando se gira o indicador de controlo para a posição AUTO, varre os resíduos para a entrada na base da unidade e os sensores detetam os resíduos iniciando automaticamente um ciclo de aspiração que terminará assim que os sensores não detetarem mais resíduos.



AUTO OFF MANUEL

Commande
AUTO OFF MANUAL
Contrôle du cadran

REF. 06612

Indicateur de l'état de la
lumière

Indicador do estado da luz

Réservoir
Depósito

Bouton manuel
Botão manual

Entrée de terre
Entrada de sujidade

Capteurs
Sensores

Filtre
Filtro

- » Puissance nominale: 1400 W
- » Modèle: VA001A-BK
- » Tension nominale: 220-240V ~
- » Fréquence: 50 / 60Hz
- » Taille: (longueur x largeur x hauteur): 33 cm de long x 21 de large x 56,4 cm de haut
- » Poids net: sur 5,1 kg
- » Opération Bruit: ≥83db 1.5m
- » Mode de travail automatique: Introduction de rayonnement infrarouge
- » Aspiration (force de traction): ≥2,8 kg
- » Capacité du réservoir à ordures: 2,7 L MAX
- » Taille de cordon d'alimentation: 2m+

- » Potência nominal: 1400 W
- » Modelo: VA001A-BK
- » Tensão nominal: 220-240V ~
- » Frequência: 50 / 60Hz
- » Tamanho: (comprimento x largura x altura): 33 cm de comprimento x 21 de largura x 56,4 cm de altura
- » Peso líquido: cerca de 5.1 kg
- » dB: ≥83db 1.5m
- » Modo de trabalho automático: Introdução de radiação infravermelha
- » Força de tensão: ≥2,8 kg
- » Capacidade do depósito: 2.7L MAX
- » Tamanho da exposição do cabo de energia: 2m

Stérilisateur UV professionnel en aluminium Esterilizador eurostil UV Alumínio

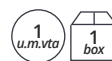

- » Puissance: 8W
- » Indiqué pour la stérilisation de petits ustensiles en plastique ou en métal, au moyen d'une ampoule uvc germicide.
- » Ne pas utiliser pour stériliser s'autres objets
- » L'ampoule dure environ 1300/1500 heures (= 1 an de fonctionnement).

- » Potência: 8W
- » Indicado para a esterilização de pequenos utensílios de plástico ou metal, através de uma lâmpada de raios uvc germicidas.
- » Não utilizar com outros objetos não indicados.
- » A lâmpada tem uma duração de cerca de 1300/1500 horas (= 1 ano de funcionamento).



REF. 03317

Stérilisateur à la chaleur sèche sanity security Esterilizador calor seco sanity security



- » Puissance: 400W
- » 20° - 200°C
- » Mesures internes: 25 cm x 14,5cm x 7cm

- » Potência: 400W
- » Medidas internas: 25cm x 14,5cm x 7cm
- » 20° - 200°C

REF. 03011



Stérilisateur EUROSTIL quartz

Esterilizador de quartzo EUROSTIL



REF. 07013

- » Quartz
- » Idéal pour les ustensiles métalliques tels que les peignes, les ciseaux, etc.
- » Comprend un sac de sphères

- » Quartzo
- » Ideal para utensílios de metal como pentes, tesouras, etc.
- » Enthält eine Tüte mit Kugeln



Pot de quartz sphères 500 gr

Caixa de esferas de quartzo 500 gr



REF. 06619

Stériliser des outils métalliques pour la coiffure et l'esthétique

- » Puissance: 400W
- » 20°C - 200°C

Esterilizar ferramentas metálicas para cabeleireiro e estética

- » Potência: 400W
- » 20°C - 200°C



Stérilisateur germicide GX4
Esterilizador germicida GX4

- » Puissance: 15W
- » Ultra plat. Lumière germicide de haute qualité

- » Potência: 15W
- » Ultra plano. Luz germicida elevada qualidade

REF. 03009/59



REF. RE00891/01

 Ampoule de recharge UV
 Lâmpada de substituição UV

Stérilisateur UV professionnel en plastique
Esterilizador eurostil UV Plástico

Stérilisateur à rayons ultraviolets pour tout type d'outils aussi bien de coiffure que d'esthétique

REF. 06618

Esterilizador de raios ultravioleta para todo o tipo de ferramentas tanto de cabeleireiro como de estética



REF. RE06618/01

 Ampoule de recharge UV
 Lâmpada de substituição UV

02

Rasoirs

NAVALHAS

*Rasoirs, lames, pen razor,
mousses à raser, gels...*

*Navalhas, lâminas, pen Razor,
espuma de barbear, gel de barbear...*



Rasoir barbiere REFINED
Navalha barbear REFINED1
u.m.vta12
box**NEW**

- » Mesure: 14,5 cm
- » Pour lame demi-tranchant ondulée
- » ACIER J2 HAUTE QUALITÉ (420C)
- » Logo marqué au laser

- » Medida: 14,5 cm
- » Para lâmina de meia borda
- » AÇO J2 ELEVADA QUALIDADE (420C)
- » Logo marcado com laser



REF.07163

- » Noir
- » Preto



- » Argent
- » Prata



REF.07161

- » Vieux cuivre
- » Cobre velho



REF.07162



Rasoir barbier PRECISE
Navalha barbear PRECISE

1 u.m.vta
100 box

- » Idéal pour les retouches et le rasage
- » Demi-lame cannelée
- » Poignée noire
- » Dimensions : 15 x 2,6 x 1,1 cm
- » Platiné pour un meilleur rasage et des retouches plus précises

- » Ideal para retoques e barbear
- » Meia folha acanalada.
- » Cabo preto
- » Medidas: 15 x 2,6 x 1,1 cm
- » Banhada a platina para um melhor barbear e retoque



NEW

REF.07124

15 cm



RAGNAR rasoir manche noir métal
RAGNAR navalha punho metal preto

1 u.m.vta
25 box

Rasoir très léger pour le rasage et les retouches de barbe et de cheveux avec manche métallique noir
Aparelho de barbear muito leve para barbear e retoques de barba e cabelo com cabo preto metálico

REF.06986



- » Lame demi-tranchant
- » Lâmina de meia borda.

23 cm



Rasoir à double lame classique. Lame de rasoir
Navalha clássica lâmina completa

Barber Line

Rasoir classique, à lame pleine et à double tranchant, un outil indispensable pour le barbier. Le rasoir a une poignée avec une texture en acier inoxydable pour une meilleure adhérence. Convient aux débutants. Prend en charge toutes les lames à double tranchant disponibles sur le marché.

Navalha clássica, com lâmina cheia e gume duplo, uma ferramenta essencial para o barbeiro. A navalha tem uma alça com uma textura de aço inoxidável para uma melhor aderência. Adequado para iniciantes. Suporta qualquer lâmina de borda dupla disponível no mercado.

- » Lame pleine double bord
 » Lâmina de borda dupla completa



REF.04929

- » Lame pleine double bord
 » Lâmina de borda dupla completa



REF.04550



- » Lame pleine double bord
 » Lâmina de borda dupla completa



REF.04933



Rasoir à Lame de rasoir classique
Navalha clássica lâmina completa



Rasoir double lame classique avec manche en plastique. Coffret élégant inclus.

Máquina clássica de barbear com lâmina dupla e punho de plástico. Inclui uma elegante caixa.

REF.04931

- » Lame pleine double bord
 » Lâmina de borda dupla completa



Le rasage peut devenir un acte de luxe et un certain sybaritisme avec Barber Line de Eurostil avec plus de 75 ans d'expérience dans le monde de la coiffure, nous avons créé cette ligne de produits pour l'homme moderne avec l'élégance du passé.

Barbear-se pode tornar-se todo um ato de luxo com Barber Line. Eurostil com mais de 75 anos de experiência no mundo da barbearia, criámos esta linha de produtos para o homem mais atual com a elegância do passado.

Rasoir barbier manche bois
Navalha barbear punho de madeira

- » Lame demi-tranchant. Interchangeable
- » Lâmina de meia borda. Trocável



REF.04930

Rasoir barbier manche plastique
Navalha barbear punho de plástico

- » Lame pleine double bord
- » Lâmina de borda dupla completa



REF.04898



Rasoir barbier manche bois
Navalha barbear punho de madeira

Lame fabriquée au Japon, acier inoxydable 430, revêtement noir, manche en bois américain de couleur orange. Comprend un étui confortable en simili cuir.

- » Lame demi-tranchant.

Peça com lâmina fabricada no Japão, aço inoxidável 430, revestimento em preto, cabo de madeira americana cor laranja. Inclui um cómodo estojo em pele ecológica.

- » Lâmina de meia borda.



REF. 04983



Rasoir barbier lame manche plastique
Navalha barbear punho de plástico

1 u.m.vta
10 box

- » Lame demi-tranchant. Interchangeable
- » Lâmina de meia borda. Trocável

REF.06057



Rasoir barbier manche métal
Navalha barbear punho de plástico

1 u.m.vta
10 box

- » Lame demi-tranchant. Interchangeable
- » Lâmina de meia borda. Trocável

REF.06058



Rasoir droit à double lame barber line
Navalha de barbear de duplo fio barber line

1 u.m.vta
12 box

- » Idéal pour les retouches.
- » Lame pleine double bord

- » Para folha inteira e ideal Para retoques.
- » Lâmina de borda dupla completa

REF.06647



Rasoir noir petit format
Navalha cor preto pequeno formato

1 u.m.vta
12 box

- » Idéal pour les retouches et pour les zones d'accès difficile
- » Lame demi-tranchant. Interchangeable

- » Ideal para retoque e para áreas de difícil acesso
- » Lâmina de meia borda. Trocável

REF.06435



Rasoir retouches
Navalha retoque

1 u.m.vta
12 box

- » Idéal pour les retouches et pour les zones d'accès difficile
- » Lame demi-tranchant. Interchangeable

- » Ideal para retoque e para áreas de difícil acesso
- » Lâmina de meia borda. Trocável

REF.06421



Rasoir avec protecteur BARBER LINE
Navalha com protetor BARBER LINE

Barber Line



- » Avec caoutchouc
- » Anneau rotatif sur la poignée pour plus de confort

- » Com borracha
- » Anel giratório no manípulo para maior conforto

REF.06417



REF.06419



- » Sense caoutchouc
- » Sem borracha

REF.06420



Pièces de rechange
Recargas

REF. 07123



REF. 04388



REF. 04389



**CONSEIL****CONSELHO**

Une fois le rasage terminé, lavez le rasoir à l'eau courante pour enlever les poils et la mousse de la lame. Séchez-le en le frottant avec un chiffon ou une serviette. Le rasage au rasoir présente de nombreux avantages, les coûts peu élevés liés au fait de ne pas acheter de lames de rechange. Se raser correctement procure souvent une plus grande douceur, un rasage de plus près et un rituel que beaucoup attendent avec impatience chaque matin.

Quando terminar de fazer a barba, lave a lâmina com água para remover o cabelo e a espuma da lâmina. Seque-o, esfregando-o com um pano ou uma toalha. Há muitos benefícios no barbear, os baixos custos de não comprar lâminas, o melhor controle das manobras de uma borda maior de uma lâmina através da pele. Barbear corretamente, muitas vezes, proporciona maior suavidade, um barbear e um ritual que muitos aguardam ansiosamente todas as manhãs.

RASOIR COUPE CHOUX captain cook
NAVALHA DE BARBEAR captain cook

Rasoir coupe choux de précision ayant un manche en bois Captain Cook et avec lame entière, idéale pour le rasage. Coffret inclus. Lame pleine double bord

Navalha de barbear de precisão com punho de madeira Captain Cook com lâmina inteira. Inclui um estojo para sua correta conservação. Lâmina de borda dupla completa



REF.04894



REF.04932



Rasoir coupe choux classique avec lame universelle interchangeable. Avec un manche en bois. Coffret simili cuir inclus. Lame demi-tranchant

Navalha clássica de barbear com lâmina trocável universal. Com punho de madeira, inclui um cómodo estojo em pele ecológica. Lâmina de meia borda.



REF.04984



REF.04985

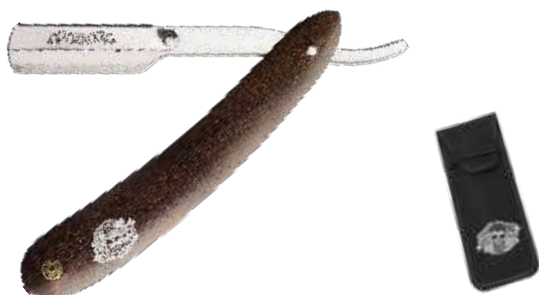



Rasoir noir petit format
Navalha cor preto pequeno formato



- » Idéal pour les retouches et pour les zones d'accès difficile
- » Lame demi-tranchant

REF.06434

- » Ideal para retoque e para áreas de difícil acesso
- » Lâmina de meia borda.



Rasoir coupe-choux petit format
Navalha de barbear pequeno formato

- » Idéal pour les retouches et pour les zones d'accès difficile
- » Lame demi-tranchant

REF.06422

- » Ideal para retoque e para áreas de difícil acesso
- » Lâmina de meia borda.



Rasoir avec protecteur et caoutchouc
Navalha com protetor e borracha



- » Avec caoutchouc
- » Anneau rotatif sur la poignée pour plus de confort

REF.06418

- » Com borracha
- » Anel giratório no manípulo para maior conforto



- » Sense caoutchouc
- » Sem borracha

REF.06423



Pièces de rechange
Recargas

REF. 07123



REF. 04388



REF. 04389



Rasoirs
Navalhas

- » Rasoir à lame interchangeable.
- » Acier inoxydable

- » Navalha lâmina trocável.
- » Aço inoxidável



1
u.m.vta

12
box

REF.02124

Rasoir coupe-choux
Navalha de barbear

- » Lame demi-tranchant. Interchangeable
- » Acier inoxydable

- » Lâmina de meia borda. Trocável.
- » Aço inoxidável



1
u.m.vta

12
box

REF.00698

Rasoir coupe-choux
Navalha de barbear

- » Lame demi-tranchant. Interchangeable
- » Avec peigne

- » Lâmina de meia borda. Trocável.
- » Com pente



1
u.m.vta

12
box

REF.00730

**Rasoir coupe- choux métallique**
Navalha de barbear de metal

- » Lame demi-tranchant. Interchangeable
- » Lâmina de meia borda. Trocável.



REF.04543

- » Lame demi-tranchant. Interchangeable
- » Poignée en caoutchouc noir

- » Lâmina de meia borda. Trocável.
- » Punho de borracha preta



1
u.m.vta

12
box

REF.04544



Distributeur de 20 lames
Dispensador 20 lâminas

Professional PB-20



REF.04391



Rasoirs FEATHER ARTIST ACS-RB
Navalhas FEATHER ARTIST ACS-RB



Artist ACS-RB

REF.04390

Rasoirs FEATHER ARTIST CLUB SS SCOTCH WOOD
Navalhas FEATHER ARTIST CLUB SS SCOTCH WOOD



Artist ACS-RSW

REF.04902

Rasoirs FEATHER DOUBLE EDGE POPULAR
Navalhas FEATHER DOUBLE EDGE POPULAR



REF.04392

Boîte de 10 lames
DOUBLE EDGE
Caixa 10 lâminas
DOUBLE EDGE



REF.04393

Carton de 10 boîtes de 100 demi-lames inoxydables pour un usage professionnel
Caixa com 10 caixinhas de 100 meias folhas inoxidáveis para uso profissional**NEW**

- » Coupe en acier inoxydable de qualité supérieure, lisse et précise
- » Inoxidável premium, corte suave e preciso

10 boîtes x 100 lames
10 caixas x 100 lâminas

REF.07164



- » Lame demi-tranchant
- » Lâmina de meia borda.

**Conteneur pour lames usées**
Contentor para depositar lâminas usadas

De taille réduite, ce conteneur est idéal pour jeter les lames de rasoir utilisées par les coiffeurs et les barbiers.

- » Couleur : noir
- » Dimensions : base 7,5 x 7,5 cm partie supérieure 9 x 9 cm / hauteur : 15 cm
- » Capacité : Env. 1 l.

De tamanho reduzido, este contentor é ideal para colocar as lâminas de barbear utilizadas por cabeleireiros e barbeiros.

- » Cor: preto
- » Dimensões: base 7,5 x 7,5 cm parte superior 9 x 9 cm / altura: 15 cm
- » Capacidade: 1 l aprox.

**NEW**

REF.07258



Distributeur de 20 boîtes de lames ELIOS
Dispensador 20 caixitas de lâminas ELIOS



- » 10 lames ondulées ELIOS
- » 10 lâminas ranhuradas ELIOS

REF. 00994

Lame de rasoir de référence pour les professionnels. Meilleure qualité de lame, meilleur affûtage et douceur d'utilisation.

Lâmina de barbear de referência para profissionais. Melhor qualidade da lâmina, melhor nitidez e uso suave.

- » Lame de rasoir en acier inoxydable
- » Acier suédois traditionnel de haute qualité
- » Traité au platine pour un rasage parfait et sûr

- » Lâmina de barbear inoxidável
- » Aço tradicional sueco de alta qualidade
- » Tratada com platina para um barbear perfeito e seguro



- » 5 lames ondulées BIC
- » 5 lâminas ranhuradas BIC



REF.01351

- » 5 lames ondulées BOLZANO
- » 5 lâminas ranhuradas BOLZANO



REF.00995

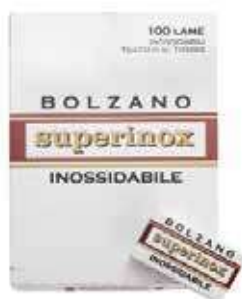

REF. 06161



REF.02956



REF.02308



- » 5 lames ondulées
- » 5 lâminas ranhuradas



- » 10 lames "Supermax"
- » 10 lâminas "Supermax"

- » 5 lames canelées DERBY PREMIUM
- » 5 lâminas com nervuras DERBY PREMIUM

Razor blades ASTRA SUPERIOR PLATINUM**Lame ASTRA SUPERIOR PLATINUM**

Lames de rasoir offrant un rasage de près et une grande douceur. Fabriquées en acier inoxydable et recouvertes de platine.

Boîte distributrice en carton contenant 20 packs de cinq lames emballées individuellement dans une enveloppe en papier paraffiné.

Lâminas com alta nitidez e ótima suavidade. Lâminas em aço inoxidável e revestimento de platina.

A caixa contém vinte caixas de papelão com cinco lâminas embrulhadas em papel de parafina em cada uma.



REF.07100

**Boîte de 100 lames jetables****Caixa 100 lâminas descartáveis****Derby Premium**

REF. 06160

Derby Professional

REF. 02955

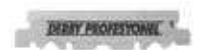
**Boîte de lames****Dispensador de laminas**

- » 10 lames Pièce de rechange haute performance pour rasoir 06192
- » 10 lâminas troca navalha

REF.09101



Boîte de rasoirs jetables avec protecteur
Caixa navalhas descartáveis com protetor



- » 100 rasoirs jetables scellés RAGNAR
- » 100 navalhas descartáveis pré-cintadas RAGNAR

REF. 07439



- » 100 rasoirs jetables Pollié
- » 100 navalhas descartáveis Pollié



REF. 02479



- » 100 rasoirs jetables
- » 100 navalhas descartáveis



REF. 01951



Boîte de rasoirs jetables
Caixa navalhas descartáveis

- » 100 rasoirs Asorti (3 couleurs)
- » Design ergonomique



REF. 03882

- » 100 navalhas surtidas (3 cores)
- » Design ergonômico



Présentoir de rasoirs 03882
Dispensador para navalhas 03882

- » Vide
- » Vazio



REF.04523



Pen razor
Pen razorIdéal pour dessiner sur les cheveux
Ideal para desenhar no cabelo

- » Rasoir Pen + 20 lames
- » Gillette barbear + 20 lâminas



REF.06154

- » Distributeur de 20 rasoirs
- » Dispensador 20 lâminas Gillette

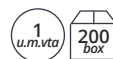

REF.06155

**Mousse de rasage bic sensible**
Espuma de barbear bic sensitive

Mousse spécialement formulée pour les peaux sensibles. Sa formule à l'aloë vera, est connue pour ses effets apaisants. Aide à soulager les irritations causées par le rasage.

Espuma especialmente formulada para peles sensíveis. Sua fórmula com aloe vera é conhecida por seus efeitos calmantes. Ajuda a aliviar a irritação causada pelo barbear.



250 ml

REF.03286

03

Ciseaux

TESOURAS

Ciseaux professionnels
Tesoura profissional



Industrias Oriol présente sa gamme de ciseaux de haute qualité. Conçus pour favoriser le travail professionnel grâce à son bord de précision. Résistants à une grande usure et avec une finition en fabrication manuelle pour une qualité et une précision maximales.

PROPRIÉTÉS DU MATÉRIAU

» En acier inoxydable VG-10 de haute qualité, cet acier est un excellent acier japonais à haute teneur en carbone. Cet acier offre une plus grande résistance à la corrosion et une plus grande capacité à retenir le bord. Sa composition est la suivante: carbone: 1,05% à 1,5%, manganèse: 0,5%, chrome: 14,5% à 15,5%, vanadium: 0,1 à 0,3%, molybdène: 0,9% à 1,2% et cobalt: 1,5%. Ce mélange donne naissance à l'acier VG-10 et ses propriétés sont inhabituelles, ce qui conduit à une résistance élevée à l'usure et donc à une durabilité élevée. Il a une dureté allant jusqu'à 62 HRC.+

» Acier inoxydable martensitique 440C: C: 1,05% Mn: 0,45% Si: 0,40% Cr: 17,50% Mo: 0,70% S: <0,030%. Ce type d'acier à haute teneur en chrome et carbone est conçu pour offrir une résistance élevée à l'usure et à l'oxydation dans les environnements humides. Il atteint des duretés proches de 60 HRC et offre une bonne rétention des arêtes. Dureté: 59-61 HRC.

TAILLE DES CISEAUX

La taille des ciseaux est généralement mesurée en pouces. Les plus courts mesurent 4,5 pouces et les plus longs atteignent environ 8 pouces. Les ciseaux sont mesurés de la pointe au manche le plus long, à l'exclusion du support du doigt amovible ou permanent. La taille est choisie en fonction de la technique de coupe. Les ciseaux plus courts sont plus adaptés au travail de précision, les longs ciseaux sont plus adaptés au travail puissant. Les ciseaux de taille 5.0 "(13cm), 5.5" (14cm), 6.0 "(15cm) et 6.5" (16cm) sont les plus utilisés par les professionnels.

TYPES DE CISEAUX ET DE POIGNÉES

Les types disponibles pouvons trouver sont:

- » Ciseaux coupe lame de rasoir: Il a deux lames droites, idéales pour effiler.
- » Ciseaux vides ou sculptés: il sont composés d'une lame dentée et d'une autre pointue, idéale pour la coupe proportionnelle des cheveux.
- » Ciseaux à micro-dents: avec une micro-scie sur une ou deux lames, idéaux pour que les cheveux ne glissent pas au moment de la coupe.
- » Ciseaux aminçissants: les deux lames sont dentelées ou peignées, idéaux pour les cheveux clairsemés réduisant le volume ou marquant des couches sans perdre la longueur.

Industrias Oriol 1942, S.L. apresenta sua linha de tesouras de alta qualidade. Projetado para favorecer o trabalho profissional graças à sua borda de precisão. Resistente ao desgaste e com acabado a mão para máxima qualidade e precisão.

PROPRIEDADES DO MATERIAL

» Aço inoxidável VG-10 de alta qualidade. Este aço é um excelente aço japonês oferece maior resistência à corrosão. A sua composição é a seguinte: carbono: 1,05% - 1,5%, manganês: 0,5%, cromo: 14,5% - 15,5%, vanádio: 0,1 - 0,3%, molibdênio: 0,9% - 1,2%, cobalto: 1,5%. Esta mistura dá origem ao aço VG-10 e suas propriedades são incomuns, o que leva a uma alta resistência ao desgaste e, portanto, duradouro. Tem uma dureza de até 62 HRC.

» Aço inoxidável 440C: C: 1,05%, Mn: 0,45%, Si: 0,40%, Cr: 17,50%, Mo: 0,70%, S: <0,030%. Este tipo de aço, projetado para oferecer alta resistência ao desgaste e oxidação em ambientes úmidos. Atinge durezas próximas a 60 HRC e oferece boa retenção de borda. Dureza: 59-61 HRC.

TAMANHO DAS TESOURAS

O tamanho das tesouras é geralmente medido em polegadas. As curtas são 4,5 polegadas e as mais longas atingem até 8 polegadas. O tamanho é selecionado dependendo da técnica de corte. As tesouras mais curtas são mais adequadas para trabalhos detalhados. As tesouras de tamanho 5.0 "(13cm), 5.5" (14cm), 6.0 "(15cm) e 6.5" (16cm) são as mais utilizadas pelos profissionais.

TIPOS DE TESOURA

Os tipos que podemos encontrar são:

- » Tesoura de corte de lâmina de barbear: Tem duas lâminas retas, ideais para cortes.
- » Tesoura vazia ou esculpida: é composta de uma lâmina dentada e outra afiada, ideal para o esvaziamento proporcional do cabelo.
- » Tesoura de corte com micro dentes: aquelas que possuem micro lamina serrilhadas, perfeitas para evitar que os cabelos deslizem para dentro no momento do corte.



4.5"

REF.06281

Poignée opposée, de base ou symétrique

Alça oposta, básica ou simétrica



5.5"

REF. 04629

Poignée semi-décalée ou semi-compensée

Alavanca Semi-Compensada ou Semi-Compensada



5.5"

REF. 04630

Poignée déportée Alavanca compensada



Ciseaux coiffeur ROOSTER
Tesoura barbeiro ROOSTER



» Matériel: Acier japonais 440C
» Dureté: 59-61 HRC

» Material: Aço japonês 440C
» Dureza: 59-61 HRC

» Coupe
» Corte

6,5"

REF.06958



» Coupe
» Corte

7"

REF.06959



» Sculpteur
» Esculpir

6,5"

REF.06960



» Coupe
» Corte

6,5"

REF.06958/71



» Coupe
» Corte

7"

REF.06959/71



» Sculpteur
» Esculpir

6,5"

REF.06960/71



Ciseaux coiffeur GLORIOUS
Tesoura barbeiro GLORIOUS



» Matériel: Acier japonais 440C
» Dureté: 59-61 HRC

» Material: Aço japonês 440C
» Dureza: 59-61 HRC

» Coupe
» Corte

6,5"

REF.06967



» Coupe
» Corte

7"

REF.06968



» Sculpteur
» Esculpir

6,5"

REF.06969



Ciseaux coiffeur LEFT DOMINANT (GAUCHERS)
Tesoura barbeiro LEFT DOMINANT (CANHOTO)1
u.m.vta10
box» Matériel: Acier japonais 440C
» Dureté: 59-61 HRC» Material: Aço japonês 440C
» Dureza: 59-61 HRC» Coupe
» Corte

6,5"

REF.06979

» Coupe
» Corte

7"

REF.06980

» Sculpteur
» Esculpir

6,5"

REF.06981

» Coupe
» Corte

6,5"

REF.06979/71

» Coupe
» Corte

7"

REF.06980/71

» Sculpteur
» Esculpir

6,5"

REF.06981/71





Ciseaux coiffure BLACK PEARL
Tesoura barbeiro BLACK PEARL

1 u.m.vta
10 box

- » Matériel: Acier japonais 440C
- » Corps: titane noir
- » Vis: Réglage des doigts avec roulement à billes
- » Dureté: 62HRC
- » Poignée: décalée

- » Material: Aço japonês 440C
- » Corpo: titânio
- » Parafuso: ajuste do dedo com rolamento de esferas
- » Dureza: 62HRC
- » Aperto: Offset



- » Coupe
- » Corte



5,5"

REF.06392

- » Sculpteur
- » 32 dents obliques

- » Esculpir
- » 32 dentes oblíquos



6"

REF.06393



- » Matériel: SUS440C
- » Dureté: 60HRC
- » Bord: convexe

- » Material: SUS440C
- » Dureza: 60HRC
- » Rebordo: convexo

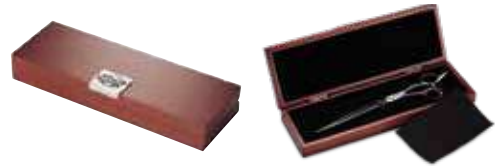

- » Coupe
- » Corte



7"

REF.04895

- » Sculpteur
- » 50 dents

- » Esculpir
- » 50 dentes



7"

REF.04896





Ciseaux coiffure CAPTAIN COOK
Tesoura barbeiro CAPTAIN COOK

1 u.m.vta
10 box



- » Matériel: Acier japonais 440C
- » Corps: titane noir
- » Vis: Réglage des doigts avec roulement à billes
- » Dureté: 62HRC
- » Poignée: décalée

- » Material: Aço japonês 440C
- » Corpo: titânio
- » Parafuso: ajuste do dedo com rolamento de esferas
- » Dureza: 62HRC
- » Aperto: Offset



- » Sculpteur
- » 32 dents obliques

- » Esculpir
- » 32 dentes oblíquos

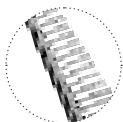

6"

REF.06394

Ciseaux coiffure BLACK RIPPER
Tesoura barbeiro BLACK RIPPER

1 u.m.vta
10 box

Acier japonais 440C. Ses lames fabriquées avec un degré d'affûtage supérieur. Idéales pour tous les types de coupes coupent les cheveux humides et secs. Ces ciseaux ont un design audacieux et moderne. 32 dents droites.

Aço japonês 440C. Suas lâminas foram fabricadas com um grau superior de afiação, o que as torna ideais para todos os tipos de corte, com cabelos molhados ou secos. Estas tesouras são design arrojado e moderno, mas sem entrar em conflito com o estilo "old school". 32 dentes retos.



- » Sculpteur
- » Esculpir

6"

REF.06478



- » Sculpteur
- » Esculpir

6"

REF.06479





03

CISEAUX · TESOURAS

Ciseaux CAPTAIN COOK · Tesouras CAPTAIN COOK

Ciseaux coiffeur SILVER DIAMOND
Tesoura barbeiro SILVER DIAMOND

1 u.m.vta 10 box

- » Matériel: Acier japonais 440C
- » Corps: titane
- » Vis: Réglage des doigts avec roulement à billes
- » Dureté: 62HRC
- » Bord: Convexe
- » Poignée: décalée

- » Coupe
- » Corte

8"

REF.04897



- » Material: Aço japonês 440C
- » Corpo: titânio
- » Parafuso: ajuste do dedo com rolamento de esferas
- » Dureza: 62HRC
- » Rebordo: Convexo
- » Aperto: Offset

Ciseaux coiffeur BLACK QUENN
Tesoura barbeiro BLACK QUEEN

1 u.m.vta 10 box

- » Matériel: Acier japonais 440C
- » Dureté: 59-61 HRC

- » Coupe
- » Corte

6,5"

REF.06961



- » Material: Aço japonês 440C
- » Dureza: 59-61 HRC

- » Avec poignée rotative
- » Com alça rotativa



Ciseaux coiffeur LEGEND
Tesoura barbeiro LEGEND

1 u.m.vta 10 box

- » Matériel: Acier japonais 440C
- » Dureté: 59-61 HRC

- » Material: Aço japonês 440C
- » Dureza: 59-61 HRC

- » Coupe
- » Corte

6,5"

REF.06962



- » Sculpteur
- » Esculpir

6,5"

REF.06963



Ciseaux coiffeur NEPTUNO

Tesoura barbeiro NEPTUNO



- » Acier 440
- » Rasoir affûté
- » Finition manuelle
- » Grande dureté 59,61 HRC
- » Vis de réglage
- » Coffret individuel

- » Aço 440
- » Lamina afiada
- » Acabamento manual
- » Grande dureza 59,61 HRC
- » Parafusos de ajuste
- » Estojo individual

- » Coupe
- » Corte



6,5"
REF. 04625

- » Sculpteur
- » Esculpir



6,5"
REF. 04626

Ciseaux coiffeur BARBER LINE

Tesoura barbeiro BARBER LINE



- » Coupe
- » Corte

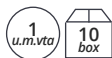

7,5"
REF.04899

- » Matériel: Acier 440C
- » Dureté: 60HRC
- » Bord: Convexe

- » Material: Aço 440C
- » Dureza: 60HRC
- » Rebordo: Convexo



- » Coupe
- » Corte



4,5"

REF.06281

- » Idéal pour retoucher la barbe
- » Ideal para retocar a barba



Ciseaux PIRATA

Tesoura PIRATA

- » Coupe
- » Corte



5,5"

REF. 04630



Ciseaux avec lames en acier WAVES
Tesoura corte aço WAVES

1 u.m.vta 12 box

» Coupe
» Corte

6"
REF.04316

» Sculpteur
» Esculpir

5,75"
REF.04317



Ciseaux professionnels ERGO
Tesoura professional ERGO

1 u.m.vta 12 box

» Coupe
» Corte

6"
REF.04314

» Sculpteur
» Esculpir

6"
REF.04315



Ciseaux professionnels RUBI
Tesoura professional RUBI

1 u.m.vta 12 box

» Coupe
» Corte

5"
REF.04319

» Sculpteur
» 25 dentes

5,5"
REF.04401

» Esculpir
» 25 dentes



Ciseaux avec lame noir et manche doré
Tesoura lamina afiada, cor preto, aperto dorado

1 u.m.vta
12 box

» Coupe
 » Corte

5,5"

REF.04499



» Sculpteur
 » Esculpir

5,5"

REF.04500



Ciseaux avec lame de rasoir noir mat
Tesoura lamina afiada, cor preto mate

1 u.m.vta
12 box

» Coupe
 » Corte

5,5"

REF.04501



» Sculpteur
 » Esculpir

5,5"

REF.04502



Ciseaux INITIATION
Tesouras INICIAÇÃO

 1
 u.m.vta 12
 box

 » Coupe
 » Corte

6"

REF.04358

 » Coupe
 » Corte

6,5"

REF.04359

 » Coupe
 » Corte

7"

REF.04360

 » Sculpteur
 » Esculpir

6,5"

REF.04361

Kit de coupe de cheveux pour étudiants
Kit corte estudantes

 1
 u.m.vta 50
 box

 » 1 ciseaux de coupe
 » 1 ciseaux sculpteur
 » 1 rasoir coupe choux en métal

 » 1 tesoura corte
 » 1 tesoura esculpir
 » 1 navalha metálica

6"

REF.04901



Ciseaux professionnels spéciaux POUR GAUCHERS
Tesoura profissional especial PARA CANHOTOS

- » Coupe
- » Corte

1
u.m.vta

30
box

5,5"

REF.02213



Ciseaux professionnels spéciaux POUR GAUCHERS MATT
Tesoura profissional especial PARA CANHOTOS MATT

- » Coupe
- » Corte

5,5"

REF.04503

- » Sculpteur
- » Esculpir

5,5"

REF.04504



04

Brosses & blaireaux rasage

ESCOVAS & PINCÉIS

Balais à cou, blaireaux rasage, talc coiffure...

Escovas, escovas de barbeiro, talcos para barbeiro...



Brosse à cou pour coiffeur avec réservoir de talc
Escova barbeiro com depósito talco



» Poils noirs
 » Cerdas pretas

REF.01463



REF.01463/50



REF. 00788



REF. 00788/68



Brosse à cou pour coiffeur
Escova barbeiro

» Manche en bois
 » Punho de madeira



REF. 00336

» Nylon
 » Nylon



REF. 03403

» Nylon
 » Nylon



REF. 01412



Blaireaux rasage
Pincéis



» Poils de poney et poils de porc naturels

REF. 04371

» Poils de poney

REF. 04372

» Poils de poney et de poils de porc naturels

REF. 04373

» *Cerdas naturais. Cabelo de porco e pônei*

» *Cerdas naturais. Cabelo de pônei*

» *Cerdas naturais cabelo de porco e pônei*

Ø 21



Ø 24



Ø 24



Blaireaux rasage vintage
Pincéis vintage

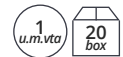

» Les poils de la brosse sont faits de poils naturels de sanglier (bouillis avec du chlore pour clarifier la couleur)
» Poils de 50 mm env. de longueur
» Manche en bois et métal

» *As cerdas do pincel são de pêlo natural de porco (fervidas com cloro para aclarar a cor)*
» *Cerdas de 50 mm aprox. de largura*
» *Punho de madeira e metal*

L

REF.00644



S

REF.00645



Bol pour savon à barbe
Bacia sabão para barba

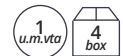

REF.04255



Bouteille brosse Talc Spartal 280gr
Frasco de escova de talco Spartal 280gr



280 gr

REF. 01293



Talc
Talco



200 gr

REF. 06428

- Absorbe l'humidité.
- Maintient la peau fraîche et sèche.
- Soulage les irritations de la peau.
- » Adoucit PAS d'allergènes et de parabens, testé dermatologiquement.
- » **MODE D'EMPLOI:** Saupoudrer sur les mains ou sur le pinceau et appliquer autant de fois que nécessaire.

- » *Absorve a humidade.*
- » *Mantém a pele fresca e seca.*
- » *Alivia a pele irritada.*
- » *Suaviza.*
- » *NÃO Allergenoss & Parabenos, dermatologicamente testados.*
- » *MODO DE UTILIZAÇÃO: Aplicar nas mãos ou na escova e aplicar sempre que necessário.*



Boîte de talc parfumé
Lata de talco perfumado



300 gr

REF. 06437



- » Absorbe l'humidité
- » Conserve la peau fraîche et sèche.
- » Soulage et adoucit la peau irritée
- » Sans parabens ni allergènes
- » Packaging innovant et respectueux de l'environnement
- » Au parfum masculin
- » Conteneur innovant

- » *Absorve a humidade*
- » *Mantém a pele fresca e seca*
- » *Alivia a pele irritada e suaviza*
- » *Sem parabenos nem alérgenos*
- » *Packaging novo e que respeita o meio ambiente*
- » *Com perfume masculino*
- » *Contentor inovador*



Peigne spécial barbe
Pente especial de barba



REF.06176



Kit rasage
Kit de barbear



Set de rasage classique pour hommes qui ne veulent pas renoncer au plaisir de se raser à l'ancienne. Il contient un rasoir pour un rasage précis, une brosse ergonomique qui apportera du confort et un bassin, outil indispensable pour tout coiffeur. Rasez à l'ancienne et obtenez un rasage parfait et précis en quelques minutes seulement.

kit de barbear clássico para homens gourmet que não querem perder o prazer de fazer a barba no estilo antigo. Contém uma lâmina de barbear precisa, uma escova ergonômica que irá proporcionar conforto e uma bacia, ferramenta indispensável para qualquer barbeiro. Raspe a moda antiga e obtenha um barbear perfeito e preciso em apenas alguns minutos.



REF.06177

Brosses à cou Barber Line en bois Escovas cabeleireiro de madeira Barber Line

Barber Line brosse de coiffeur. Poils en nylon poli. Grande douceur et puissance de traînée. Idéal pour enlever les poils coupés du cou et de la nuque.

Escova de barbeiro Barber Line. Cerdas de nylon polido. Grande suavidade e poder de arrasto. Ideal para remover o cabelo cortado do pescoço e da nuca.



REF. 06070



Brosse TRITÓN Escovas TRITÓN

La conception de cette brosse est conçue pour traîner les restes de cheveux qui restent sur la nuque après chaque coupe. La brosse TRITON est fabriquée à 100% avec du bois naturel alors que ses dents sont 100% synthétiques. Ses poils doux traînent les restes de cheveux sans irriter.

O design deste pincel é projetado para arrastar os restos de cabelo que permanecem na nuca após cada corte. A escova TRITON é fabricada 100% com madeira natural, enquanto suas cerdas são 100% sintéticas. Suas penas suaves arrastam os restos de cabelo sem arranhar.



REF. 06076



11,5 cm



Brosses à cou barbier pics polie Escovas cabeleireiro picaretas

Brosse à bois du barbier Barber Line. Avec des pics en nylon, qui offrent une grande douceur et une grande résistance. Idéal pour enlever les poils coupés du cou.

Escova de madeira cabeleireiro Barber Line. Com cerdas de nylon, que proporcionam grande suavidade e força de arrasto. Ideal para remover pêlos cortados do nuca e pescoço.



REF.06116



Brosse à barbe POSEIDON

Escova de barbeiro POSEIDON



Son design arrondi s'adapte parfaitement à la paume de la main permettant de peigner la barbe confortablement. La brosse POSEIDON est faite à 100% avec du bois naturel. Ses dents, 50% naturelles et 50% nylon, apportent cette touche de douceur.

Seu design arredondado adapta-se perfeitamente à palma da mão, permitindo pentear confortavelmente a barba. A escova POSEIDON é feita 100% com madeira natural. As cerdas 50% naturais e 50% nylon, proporcionam toque natural.



10 cm

REF. 06078

Brosse à barbe TALASA

Escova de barbeiro TALASA



Cette brosse de taille réduite sans poignée et de forme arrondie est parfaite pour les barbes courtes. Sa petite taille nous permet d'atteindre les zones difficiles à coiffer comme la zone de la moustache. La brosse TALASA est faite à 100% avec du bois naturel. Ses dents, 50% naturelles et 50% nylon, apportent cette touche de douceur.

Esta escova de tamanho reduzido sem punho e formato arredondado é perfeita para aquelas barbas curtas. Seu tamanho pequeno nos permite alcançar as áreas difíceis de pentear como a área do bigode. A escova TALASA é feita 100% com madeira natural. As cerdas, 50% naturais e 50% nylon, proporcionam aquele toque natural.



8 cm

REF. 06073

Brosse à barbe OCEANO

Escova de barbeiro OCEANO



Le design de cette brosse est conçu pour le soin des cheveux et de la barbe. La brosse OCEANO est faite à 100% avec du bois naturel. Ses barbes 50% naturelles et 50% nylon offrent cette touche de douceur que la barbe naturelle n'offre pas.

O design deste pincel é projetado para o cuidado de cabelo e barba. A escova OCEANO é feita 100% com madeira natural. As cerdas 50% natural e 50% nylon.



20 cm

REF. 06075

Brosse à barbe APOLO

Escova de barbeiro APOLO



La conception de cette brosse est conçue pour ces barbes denses et difficiles à peler. Sa large taille permet de larges zones de brossage et d'inégalité de la barbe. La brosse APOLO est 100% bois naturel. Ses dents 50% naturelles et 50% nylon apportent une touche de douceur que le choix naturel n'offre pas.

Este escova foi projetado para barbas densas e difíceis de escovar. A largura da escova permite escovar áreas grandes de barba. La escova APOLO é feita 100% com madeira natural. As cerdas 50% natural e 50% nylon.



15 cm

REF. 06077

Brosse circulaire en bois barber line
Escova circular de madeira barber line

1
u.m.vta

36
box



Brosse en bois en poils de sanglier, idéal pour toupets et coiffures volumineuses
 Escova de madeira com cerdas de javali ideal para topetes e penteados com volume.

REF.06671



Brosse à barbe NEREO
Escova de barbeiro NEREO

1
u.m.vta

12
box

Cette brosse de taille réduite munie d'une poignée est parfaite pour les barbes courtes. Sa poignée vous permet de peigner de petites zones comme la moustache. La brosse NEREO est fabriquée à 100% avec du bois naturel. Ses barbes 50% naturelles et 50% nylon procurent cette touche de douceur que la barbe naturelle n'offre pas.

Esta escova de tamanho reduzido é perfeita para as barbas curtas permite que penteie pequenas áreas como o bigode. A escova NEREO é feita 100% com madeira natural. As cerdas 50% natural e 50%.

Brosse GORGONAS pour les vêtements
Escova de roupa GORGONAS

1
u.m.vta

12
box

Cette brosse a été conçue pour enlever les traces de poils emprisonnés dans les vêtements après la coupe. La brosse GORGONAS est faite à 100% avec du bois naturel et ses dents sont 100% nylon. Leurs dents dures entraînent les poils et la saleté, laissant les vêtements propres. Son contrôle ergonomique permet une tenue confortable de la brosse pendant le travail.

Esta escova foi projetada para remover os resíduos de cabelos presos nas roupas após o corte. A escova GORGONAS é feita 100% com madeira natural e as cerdas são 100% nylon. São duras e arrastam os cabelos e a sujeira deixando as roupas limpas. Seu punho ergonômico permite uma fixação confortável da escova durante o trabalho.



REF. 06072



11,5 cm



REF. 06074



27 cm

Brosse pour le dégradé
Escova fade

1
u.m.vta

24
box

Brosse en plastique avec pointes en nylon doux, idéale pour les coupes "Fade"
 Escova plástica com pontas de nylon macias, ideal para cortes "desbotados"

REF. 04976



15 cm



Brosse à cou pour barbier

Escova pescoço barbeiro



- » Manche en plastique
- » Poils de nylon

- » Punho de plástico
- » Cerdas nylon



REF. 00501

- » Manche bois
- » Poils de nylon

- » Punho de madeira
- » Cerdas nylon



REF. 00595



Grande brosse à cou pour barbier

Escova barbeiro grande

- » Manche en bois
- » Poils de sanglier

- » Punho de madeira
- » Cerdas javali



REF. 00306

Brosse plate pur sanglier

Escova plana puro de javali

- » Poils de sanglier naturel
- » Cabelo natural de javali



REF. 00599



Brosse EUROSTIL
Escova EUROSTIL

- » Manche en bois
- » Poils de sanglier naturel

- » Punho de madeira
- » Cabelo natural de javali



REF. 00352



Brosse araignée courbée
Escova esqueleto curvo

- » Poils de plastique avec ballon
- » Cerdas de plástico com bola



REF. 02195/50



Brosse araignée antistatique
Escovas esqueletos antiestático

REF. 00584

- » Poils en nylon arrondis
- » Cerdas de nylon com bola

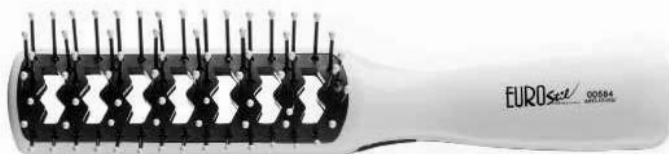
**Brosses araignée de deux**
Escovas esqueletos duplos

- » Poils en plastique
- » Cerdas de plástico



REF. 02182



REF. 02182/50

Brosse pour le dégradé
Escova fade

Brosse en plastique avec pointes en nylon doux, idéale pour les coupes "Fade"
Escova plástica com pontas de nylon macias, ideal para cortes "desbotados"

REF. 04977



05

Peignes

PENTES

*Peignes Barber Line, peignes
Captain Cook, peignes Eurostil,
peignes Silkomb*

*Pentes Barber Line, pentes
Captain Cook, pentes Eurostil,
pentes Silkomb*



Peigne de barbier
Pente de barbeiro

REF.07355

- » Noir
- » Preto



18 cm

- » Ivoire
- » Marfim



18 cm

REF.07355/82

- » Classique
- » Clássico



18 cm



REF.07355/98

Peigne de barbier coupe
Barber pente cupê

REF.07356

- » Noir
- » Preto



17,5 cm

REF.07356/82

- » Ivoire
- » Preto



17,5 cm

- » Classique
- » Clássico

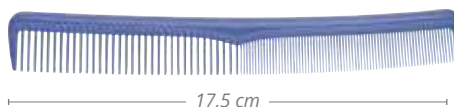

17,5 cm



REF.07356/98

- » Noir
- » Preto



19,5 cm

REF.07357

- » Ivoire
- » Marfim



19,5 cm

REF.07357/82

- » Classique
- » Clássico

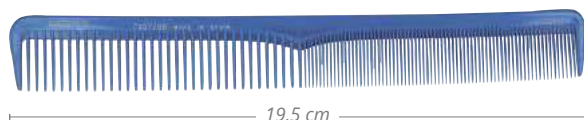

19,5 cm



REF.07357/98

Peigne de barbier batteur
Barber pente batidor



REF.07358

MOD. 04616

» Noir
» Preto



REF.07358/82

MOD. 04616/82

» Ivoire
» Marfim



REF.07358/98

MOD. 04616/98

» Classique
» Clássico



REF.07359

MOD. 00113

» Nylon - Noir
» Nylon - Preto



REF.07360

MOD. 00424

» Renforcé - Noir
» Reforçado - Preto

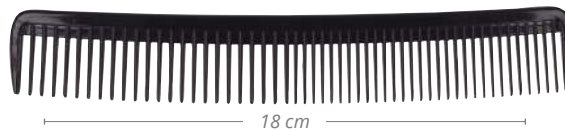

REF.07361

MOD. 00454

» Droit - Noir
» Recto- Preto

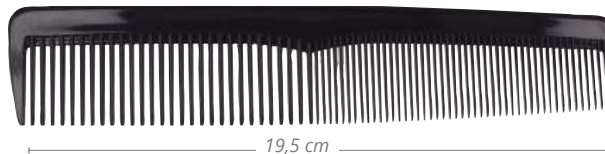

REF.07362

MOD. 00455

» Mèches - Noir
» Mechas - Preto



Peigne carbone RAGNAR
Pente carbono RAGNAR



REF.07367

MOD. 02216

» Bateur de coupe
» Batidor corte

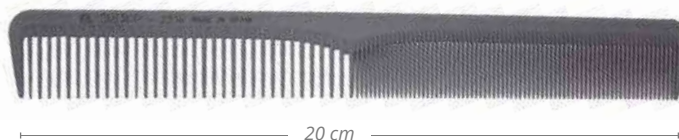

REF.07368

MOD. 02215

» Spécial
» Especial



Peigne barbier coupe spécial machine

Pente de barbeiro de corte especial

- » Peigne de coupe spécial professionnel
- » Pente corte especial máquina profesional

MOD. 02183

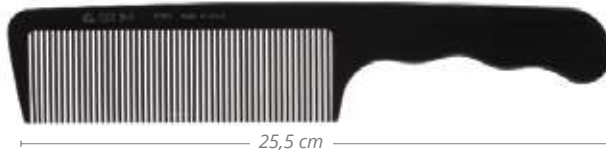

REF.07363

- » Peigne de coupe spécial professionnel
- » Pente corte especial máquina profesional

MOD. 06802



REF.07364

MOD. 06802/82



REF.07364/82

Peigne barbier afro

Pente de barbeiro dentes largos

- » Noir
- » Preto

MOD. 00419/50



REF.07365/50

- » Noir
- » Preto

MOD. 00409/50



REF.07366/50

- » Bois
- » Madeira

MOD. 00409



REF.07366/55

Ligne de peignes CAPTAIN COOK
Linha de pente CAPTAIN COOK



REF. 04981

» Carbone
 » Carbono



» Noir
 » Preto

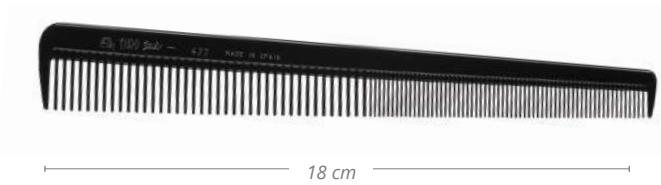

REF.07441

» Ivoire
 » Marfim



REF.07441/82

» Negro
 » Black



REF.07442

» Ivoire
 » Marfim



REF.07442/82

» Noir
 » Preto



REF.07443

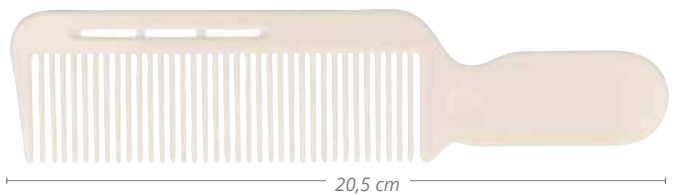

REF.07443/82

» Mèches / Noir
 » Mechas - Preto



REF.07444



SPÉCIAL POUR BARBE ET MOUSTACHE
ESPECIAL BARBA E BIGODE



Peigne bois barbe moustache
Pente maderá barba-bigode

» À larges
» Largo

12 u.m.vta
60 box

» Avec manche
» Com punho

12 u.m.vta
96 box

REF.04548

REF.04549



9 cm



10 cm

Peigne coquille pour barbe - moustache
Pente concha barba - bigode

» À long manche
» Cabo largo

12 u.m.vta
120 box

12 u.m.vta
120 box

REF.04546

REF.04547

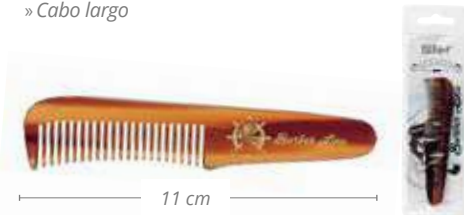

11 cm



8 cm

» Pliage
» Dobrável

12 u.m.vta
96 box

REF.04545



11,5 cm ouvert - aberto

6,5 cm fermé - fechado



Peigne batteur EUROSTIL
Pente batidor EUROSTIL



» Spécial
» Especial



REF. 00115

» Spécial
» Especial



REF. 00442

» Spécial
» Especial



REF. 00441

» Spécial
» Especial



REF. 00424

» Grand
» Grande



REF. 00116

» Spécial
» Especial



REF. 01470

Peigne batteur spécial
Pente batidor especial

REF. 00422



REF. 00422/58



Peignes carbone
Pentes carbono

REF. 02186

» Batteur de coupe
» Batidor corte

17,5 cm

REF. 02216

» Batteur de coupe
» Batidor corte

19,5 cm

REF. 02214

» Batteur spécial à dents
» Batidor dente especial

17,5 cm

REF. 02215

» Spécial de coiffure
» Especial cabeleireiro

18 cm

REF. 02187

» Spécial à dents
» Dentição especial

20,5 cm



REF. 02188

» Modèle RECTO
» Mmod. RECTO

19,5 cm

Peignes professionnels SILKOMB
Pente professional SILKOMB

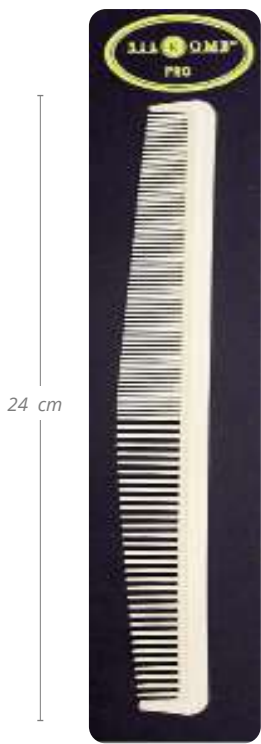

PRO-10
 REF. 01520

24 cm

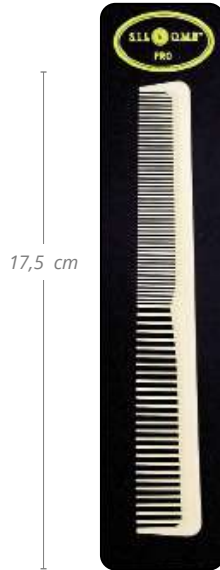

PRO-11
 REF. 01521

17,5 cm

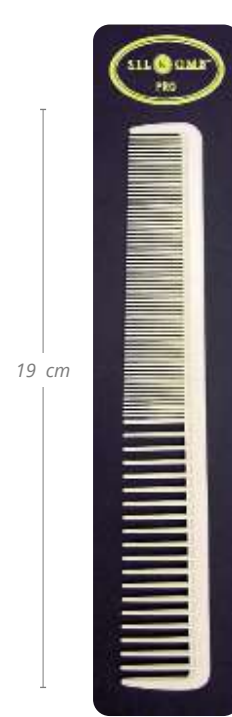

PRO-20
 REF. 01522

19 cm



PRO-30
 REF. 01523

19 cm

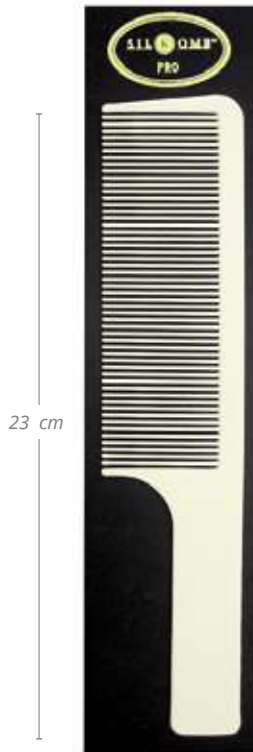

PRO-40
 REF. 01524

23 cm



PRO-50
 REF. 01525

22,5 cm

Peigne avec niveaux**Pente com níveis**

REF. 04349

Le peigne avec niveaux permet de faire une coupe ou une mise à l'échelle dans une ligne droite parfaite grâce à ses 3 niveaux

O pente com níveis permite realizar um corte ou escalado em linha reta perfeita graças aos seus 3 níveis



22 cm

Brosse de nettoyage peigne**Escova de limpeza pentes**

REF. 00600



11,5 cm



natural colours:
nco
organic

Cosméticos

COSMÉTICOS

*Cosméticos capillares cosméticos
barbe, fixations cosmétiques*

*Cosméticos capilares, cosméticos para
barba, artigos de fixação cosmética*





Shampooing rafraîchissant Champô refrescante



250 ml PH 5.5

REF. 04963



750 ml PH 5.5

REF. 04964



NEW



500 ml PH 5.5

REF. 07374

NEW

1L PH 5.5

REF. 07375

Régulateur de cuir chevelu

Avec des tensioactifs doux et un pouvoir mouillant élevé, abaissant la tension superficielle de l'eau. Pour ses actifs, il possède des propriétés de conditionnement des cheveux pour faciliter le peignage, apporte de l'humidité pour surmonter la sensation de sécheresse et de fragilité, contrôle la production de cellules mortes dans le cuir chevelu, exerce une activité antibactérienne et antifongique. Idéal pour les cheveux et les cuirs chevelus sensibles.

Regulador do couro cabeludo

Com surfactantes suaves, alto poder de umedecimento, que reduz a tensão superficial da água. Por seus ativos, possui propriedades condicionantes para facilitar o penteado, proporciona umidade para superar a sensação de secura e fragilidade, controla a produção de células mortas no couro cabeludo, exerce atividade antibacteriana e antifúngica. Ideal para cabelos e couro cabeludo sensíveis.

Shampooing pour cheveux gris Champô cabelos grisalhos

250 ml PH 5.5

REF. 04965



NEW



500 ml PH 5.5

REF. 07376

NEW

1L PH 5.5

REF. 07377

Pour les cheveux gris

Avec des tensioactifs doux et un pouvoir mouillant élevé, abaissant la tension superficielle de l'eau. Pour ses actifs conditionne les cheveux pour les rendre plus faciles à coiffer et avec des pigments d'origine végétale qui empêchent le changement de couleur dans les cheveux gris rallumant l'éclat. Spécial pour les cheveux gris, prévient et couvre le ton jaunâtre.

Para cabelos grisalhos

Com surfactantes suaves, alto poder de umedecimento, que reduz a tensão superficial da água. Por seus ativos condiciona o cabelo para facilitar o pentear, com pigmentos de origem vegetal que impedem a mudança de cor nos cabelos grisalhos reacendendo o brilho. Especial para cabelos grisalhos, previne e cobre o tom amarelado.

Shampooing rafraîchissant Champô refrescante



250 ml PH 5.5

REF. 04869



NEW

500 ml PH 5.5

REF. 07370

NEW

1L PH 5.5

REF. 07371

Particulièrement indiqué pour prévenir et combattre la chute des cheveux, stimulant le cuir chevelu et apportant une vitalité renouvelée. Il réduit le sébum, redonnant aux cheveux leur éclat naturel.

Especialmente indicado para prevenir e combater a queda de cabelo, estimula o couro cabeludo dando-lhe uma nova vitalidade. Reduz o sebo devolvendo ao cabelo o seu brilho natural.

Crème adoucissante Condicionador



250 ml PH 5.5

REF. 04870



NEW

500 ml PH 5.5

REF. 07372

NEW

1L PH 5.5

REF. 07373

Supplément de shampooing. Elle incorpore les propriétés rafraîchissantes et stimulantes du cuir chevelu, restaurant son hydratation et son éclat naturel.

Complementa o champô. Contém propriedades refrescantes e estimulantes do couro cabeludo, devolvendo a sua hidratação e brilho natural.



Pommade coiffante et fixation douce
Pomada de penteado de fixação suave



1 u.m.vta 6 box

200 ml

REF. 04867

1 u.m.vta 6 box

100 ml

REF.06232

1 u.m.vta 16 box

50 ml

REF.06233



Idéale pour les styles exigeants qui veulent avoir un aspect parfait. Elle vous donnera de la brillance et une fixation souple et sans laisser de résidus. À base d'eau, qui apporte douceur et hydratation aux cheveux.

Ideal para estilos exigentes que pretendam um aspeto perfeito. Dará brilho e uma fixação suave e flexível sem deixar resíduos. À base de água, o que dá uma suavidade e hidratação ao cabelo.

Pommade coiffante et fixation moyenne
Pomada de penteado de fixação média



1 u.m.vta 6 box

200 ml

REF. 06229

1 u.m.vta 6 box

100 ml

REF.06230

1 u.m.vta 16 box

50 ml

REF.06231



Application facile de cire à la crème pour maintenir et définir la coiffure désirée. Avec des cires naturelles et du beurre de karité qui protègent et soignent les cheveux. Fini mat naturel pour tout type de coiffure.

Cera pomada fácil aplicação para manter e definir o penteado desejado. Com ceras naturais e manteiga de karité que protegem e cuidam dos cabelos. Fixação mate natural para qualquer tipo de penteado.

Pommade coiffante et fixation forte
Pomada de penteado de fixação forte

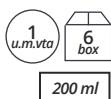

REF. 04866

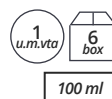

REF.06236

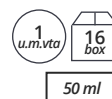

REF.06237



Elle fournit de la brillance et une forte fixation tout en laissant les cheveux souples, faciles à enlever sans laisser de résidus. À base d'eau, qui apporte douceur et hydratation à la finition.

Dá brilho e uma fixação forte, mas deixando o cabelo flexível, de fácil eliminação sem deixar resíduos. À base de água, o que dá uma suavidade e hidratação ao cabelo.

Pommade coiffante mate et fixation Rubber Matt
Pomada de penteado, fixação Rubber Matt

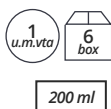

REF. 04868

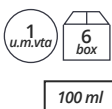

REF.06234

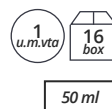

REF.06235



Pommade coiffante Mate et Fixation RUBBER MATE. Elle permet de donner forme et volume aux cheveux en obtenant une coiffure durable. Séchage rapide et finition mate. Elle ne laisse pas de résidus. Grâce à sa composition riche en cires naturelles elle apporte douceur et protection aux cheveux

Pomada de penteado fixação mate RUBBER MATE. Permite dar forma e volume ao cabelo conseguindo um penteado duradouro. De secagem rápida e fixação mate. Não deixa resíduos. A sua composição rica em ceras naturais dá suavidade e proteção ao cabelo.

Cire fibreuse modelante fixation forte Spider Gum
Cera fibrosa modelagem fixação forte Spider Gum



1 u.m.vta
6 box

200 ml

REF. 06677

1 u.m.vta
6 box

100 ml

REF.06678

1 u.m.vta
16 box

50 ml

REF.06679



Cire fibreuse pour modeler et texturiser les cheveux, à fixation forte, longue durée et facile à éliminer.

Mode d'application: prendre une petite quantité de produit entre les doigts, la chauffer en frictionnant les mains pour activer les fibres et appliquer sur les cheveux pour donner la forme souhaitée.

Cera fibrosa para moldar e texturizar o cabelo de fixação forte, longa duração e fácil de eliminar.

Modo de aplicação: aplique uma pequena quantidade de produto entre os dedos, aquecê-l com a fricção das mãos para ativar as fibras e aplicar sobre o cabelo, dando-lhe a forma desejada.

Fixation à effet sec gravity zero

Fixação a seco gravity zero



1 u.m.vta
10 box

Gravity Zero: Grâce à sa composition, il laisse sur les cheveux un film invisible d'effet sec avec un grand volume et un pouvoir hydratant. Idéal pour tout type de cheveux offrant une luminosité. Puissant même avec une humidité et une température élevées. Vaporiser directement sur les cheveux et peigner selon le style désiré.

Gravity Zero: Graças à sua composição, deixa no cabelo uma película invisível de efeito seco com grande volume e poder hidratante. Ideal para qualquer tipo de cabelo, proporcionando brilho. Poderoso mesmo com alta umidade e temperatura. Pulverize diretamente sobre o cabelo e penteie de acordo com o estilo desejado.



125 ml

REF. 04961

Laque professionnelle forte Laca profissional forte



Elle apporte aux cheveux une excellente fixation et une brillance naturelle tout en les protégeant des agents extérieurs tels que le vent, l'humidité, etc.

Elle permet de conserver une coiffure intacte toute la journée. Effet Long Lasting. Elle s'élimine facilement avec un léger brossage. Elle renforce la fibre capillaire.

Proporciona ao seu cabelo uma excelente fixação e um brilho natural, ao mesmo tempo que o protege de agentes externos como o vento, humidade, etc.

Mantém o penteado perfeito durante todo o dia. Efeito Long lasting. Elimina-se facilmente com uma leve escovagem. Fortalece a fibra capilar.



300 ml

REF.07129

NEW

Laque écologique Laca ecologica



Captain Cook Hair Spray est idéal pour les structurés. Il respecte le cheveu grâce à l'action de la provitamine B5. Sa diffusion micro-fine ne surcharge pas les cheveux et il s'élimine facilement au brossage.

O capitão Cook Spray para cabelos é ideal para trabalhos estruturados, respeita os cabelos graças à ação da provitamina B5. Sua difusão por micro-difusão não sobrecarrega o cabelo e é facilmente removida ao escovar.



300 ml

REF.07113

Gel boucles CAPTAIN COOK CAPTAIN COOK curl gel



La crème définition de boucles a été spécialement conçue pour définir simplement et facilement les boucles et les ondulations des cheveux. Les protéines de blé apportent hydratation et brillance, et évitent les frisottis. Créez votre look avec vos doigts. Laisser sécher à l'air ou utiliser un diffuseur pour une définition optimale des boucles.

Bienfaits

- » Définition des boucles
- » Hydratation maximale
- » Volume

Creme que define e amplifica os cachos dando um aspecto natural. Enriquecido com Proteínas do Trigo.

O creme de definição de cachos é especialmente formulado para desenhar cachos e ondas nos cabelos de forma fácil e confortável. As proteínas do trigo proporcionam hidratação e brilho, evitando o frizz. Modele seu visual com os dedos. Deixe secar ao ar ou difundir para uma definição ideal dos cachos.

Benefícios

- » Definição de caracóis
- » Máxima Hidratação
- » Volume



250 ml

REF.07378

NEW

Poudre volumisante Gravity Powder

Pó volumizante Gravity Powder

» Avec pulvérisateur
» Com pulverizador

Meilleur prix
produit de l'année
Premio melhor
produto do ano

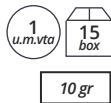

REF. 06473

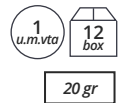

REF. 04962

Gravity Powder: poudre matifiante à texture ultra légère. Il apporte un grand volume aux cheveux, avec son application facile en massant au minimum la racine des cheveux. Idéal pour fixer des coiffures très structurées. Effet mat doux Grâce à ses actifs, il ne laisse pas de cheveux gras, même dans les cheveux sujets, contribuant à absorber l'excès de séborrhée. Sans control. Fixation durable

Gravity Powder: pó matificante de textura ultra leve. Traz grande volume ao cabelo, com sua fácil aplicação massageando minimamente a raiz do cabelo. Ideal para a fixação de penteados muito estruturados. Efeito fosco suave Graças aos seus ativos, ele não deixa os cabelos oleosos, mesmo nos cabelos propensos, ajudando a absorver o excesso de seborreia. Fixação durável

Shampooing au Bourbon

Champô Bourbon

Captain Cook Hair Spray est idéal pour les structurés. Il respecte le cheveu grâce à l'action de la provitamine B5. Sa diffusion micro - fine ne surcharge pas les cheveux et il s'élimine facilement au brossage.

O capitão Cook Spray para cabelos é ideal para trabalhos estruturados, respeita os cabelos graças à ação da provitamina B5. Sua difusão por micro-difusão não sobrecarrega o cabelo e é facilmente removida ao escovar.



5 L

REF. 07096

Pack barbe

Pack barba

Il contient un shampooing pour barbe 250 ml + huile à barbe 30 ml + cire à barbe 50 ml.

Inclui shampoo barba 250 ml + óleo para barba 30 ml + cera para barba 50 ml.

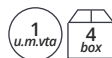

REF. 06668

Pack cheveux

Pack cabelo

Il contient un shampooing rafraîchissant 250 ml + Gravity Powder 20 g + cire mate 50 ml.

Inclui shampoo refrescante 250 ml + Gravity Powder 20 g + cera mate 50 ml.

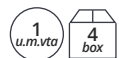

REF. 06669



Besoin de vide
Precisa vazia

REF. 07079

Huile avant rasage Óleo pré-barbear



30 ml

REF. 04860

Huile pour la barbe Óleo para barba



30 ml

REF. 04861

Cire à barbe Cera para barba



50 ml

REF. 04865

Pour une expérience de rasage agréable. Produit spécialement conçu pour traiter la peau avant le rasage. Contient des actifs rafraîchissants qui aident à faire glisser la lame en toute sécurité.

Para una experiencia agradable de barbear. Producto especialmente concebido para tratamiento da pele antes de barbear.

Barbe saine et maniable. Mélange d'huiles naturelles qui nourrissent et hydratent les cheveux de la barbe en les aidant à rester en bonne santé et à les gérer. Pas gras

Barba saudável e Maleável. Mistura de Óleos Naturais que nutrem e hidratam a barba ajudando-a a manter saudável e maleável. Não oleoso.

Dominez votre barbe. Forte concentration d'actifs naturels tels que l'huile d'argan et la rose musquée, qui protègent et nourrissent les cheveux en profondeur sans donner de sensation de graisse.

Domina a tua barba. Alta concentração de ativos naturais como Óleo de Argão e Rosa Mosqueta, que protegem e nutrem o pêlo em profundidade sem deixar nenhuma sensação de oleosidade.

Shampooing pour barbe Champô para barba



250 ml

PH 5.5

REF. 04862

Crème de barbear Crème de rasage



250 ml

PH 5.5

REF. 04863

Crème pós barbear Crème après-rasage



250 ml

PH 5.5

REF. 04864

Nettoyage en profondeur. Savon nettoyant aux propriétés hydratantes et adoucissantes. Il produit une mousse dense qui élimine les impuretés.

Limpeza Profunda. Sabão de limpeza com propriedades hidratantes e suavizantes. Produz uma espuma densa, que arrasta as impurezas.

Le rasage est facile ... Formulée avec des ingrédients actifs doux et hydratants pour la protection de la peau. Spécialement conçue pour ouvrir les pores, hydrater la peau et adoucir la barbe pour faciliter le rasage.

Barbear é fácil... Fórmula com ativos suaves e hidratantes para a proteção da pele. Especialmente desenhado para abrir os poros, hidratar a pele e amolecer a barba para facilitar o barbear.

Idéale pour les peaux sensibles. Ses composants régénérants et apaisants la rendent idéale pour le rasage, produisant une agréable sensation de fraîcheur et d'hydratation.

Ideal para peles sensíveis. Os seus componentes regenerativos e calmantes o tornam ideal para depois do barbear, dando uma sensação agradável de frescura e hidratação.

Petit présentoir captain cook
Pequeno EXPOSITOR captain cook

- » 6 unités de chaque ref. de barbe (04860 à 04865)
- » CADEAU: présentoir en bois, 4 chemises, 1 casquette, 1 sac, 25 catalogues

» 6 unidades de cada ref. de barba (04860 a 04865)

» GRATIS: display de madeira, 4 camisas, 1 boné, 1 bolsa, 25 catálogos



REF.04945

Petit présentoir Pomade captain cook
Pequeno Pomada EXPOSITOR captain cook

- » 6 pommades de chaque ref. (50 ml y 100 ml)
- » CADEAU: présentoir en bois, 2 affiches, 25 catalogues, 1 sac, 1 chapeau

» 6 pomadas de cada ref. (50 ml e 100 ml)

» GRATIS: display de madeira, 2 cartazes, 25 catálogos, 1 bolsa, 1 chapéu



REF.06441

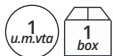

Affichage vide;
 Exibição vazia

REF.04945/01



Affichage vide
 Empty display

REF.06441/01

Présentoir grand captain cook barbe + cheveux
Expositor grande captain cook barba + cabelo



- » 2 unités de chaque référence.
- » CADEAU: présentoir en bois, 8 t-shirts, 2 casquettes, 2 sacs et 50 catalogues.

» 2 unidades de cada referência.

» GRATIS: display de madeira, 8 camisetas, 2 bonés, 2 malas e 50 catálogos.



REF.04944



Affichage vide
 Exibição vazia

REF.04944/01



THE SHAVING CO. c'est un concept de style de vie 100% mexicain qui définit l'homme moderne, avec une collection de produits de soins personnels pour hommes fabriqués à la main, développés avec la meilleure technologie et les ingrédients de la plus haute qualité qui caractérisent nos produits dans le monde entier. Depuis 2014, THE SHAVING CO. combine l'expérience parfaite de nos salons de coiffure exclusifs avec la créativité de nos artistes et designers, toujours à l'avant-garde avec des produits et des traitements pour le soin des cheveux des hommes. RASAGE CO. C'est une expérience unique et inévitable qui harmonise la "masculinité" avec le "style de vie", depuis la conception d'un toilettage optimal, fondé sur le bien-être et le respect de l'environnement.

Notre collection de 25 produits est présentée dans quatre séries spécialisées:

CHEFS D'OEUVRE COIFFANTS

SÉRIE NOXIDIL R

SÉRIE BEARD

SÉRIE DE RASAGE

The shaving co. é um conceito de estilo de vida 100% mexicano que define o homem moderno, com uma coleção de produtos de cuidados masculinos feitos à mão, desenvolvidos com a melhor tecnologia e ingredientes da mais alta qualidade que caracterizam nossos produtos em todo o mundo. Desde 2014, o THE SHAVING CO. combina a perfeita experiência de nossas barbearias exclusivas com a criatividade de nossos artistas e designers, sempre na linha de frente com produtos e tratamentos para o cuidado do cabelo dos homens. SHAVING CO. é uma experiência única e inevitável que harmoniza a "masculinidade" com o "estilo de vida", a partir da concepção de uma higiene ideal, baseada no bem-estar e no cuidado com o meio ambiente.

Nossa coleção de 25 produtos é apresentada em quatro séries especializadas:

SÉRIE DE CABELO MASTERPIECES STYLING

SÉRIE NOXIDIL R

SÉRIE BEARD

SÉRIE DE BARBETE

Régénérateur de cheveux
Regenerador de cabelo

1 u.m.vta 6 box

120 ml 240 ml

REF.06386

Cires pour les cheveux
Ceras para cabelos

1 u.m.vta 12 box

Original

113 gr

REF.06381

Taille: shampooing 240 ml + lotion 100 ml

Avantages:

- » Il aide à la croissance des cheveux.
- » Il élimine les peaux mortes permettant le nettoyage et l'amélioration de la peau abîmée.
- » Stimule la microcirculation dans le follicule.
- » Régule la sécrétion des glandes sébacées en hydratant et en nourrissant les cheveux, les rendant plus épais
- » Augmenter le volume des cheveux
- » Rajeunit les racines des cheveux
- » Les cheveux qui poussent ne sont pas perdus.
- » Contient des ingrédients ECO CERT
- » Sans sulfate
- » Sans paraben

Tamanho: shampoo 240 ml + loção 100 ml

Benefícios:

- » Ajuda no crescimento do cabelo
- » Elimina a pele morta permitindo a limpeza e melhoria da pele danificada.
- » Estimula a microcirculação no folículo
- » Regula a secreção das glândulas sebáceas hidratando e nutrindo o cabelo, tornando-o mais espesso
- » Aumenta o volume do cabelo
- » Rejuvenesce as raízes do cabelo.
- » Contém ingredientes ECO CERT
- » Sem sulfatos
- » Sem parabenos

Hair Pomades est la série de pommades à base d'eau qui offrent une gamme complète pour chaque besoin et le goût spécifique. Que votre style soit pompadour, queue de canard, décoloration ou tout simplement une coupe classique, Hair Pomades ne sèche pas ou laisse vos cheveux durs et craquants vous permettant de peigner vos cheveux encore et encore pendant la journée. Grâce à sa formule avancée, Hair Pomades se lave facilement sans laisser de résidus gras, étant l'option la plus populaire aujourd'hui pour le soin et le peignage des cheveux.

Fixation - Fixation moyenne
 Finition: Luminosité moyenne

Avantages

- » Vous permet de peigner vos cheveux encore et encore pendant la journée.
- » Il ne sèche pas et ne laisse pas les cheveux durs et collés.
- » Tenue moyenne / Brillance moyenne.
- » Écrémé.
- » Il enlève les cheveux facilement.
- » Fixer les cheveux, mais peut facilement être retiré avec de l'eau.
- » Cela ne cause pas l'acné.

Hair Pomades, é a série de pomadas à base de água que oferecem uma gama completa para cada necessidade específica e sabor. Se o seu estilo é penteado, duck tail fade ou simplesmente um corte clássico, as Pomadas capilares não secam nem deixam o cabelo duro, permitindo pentear o cabelo repetidamente durante o dia. Graças à sua fórmula avançada, o Hair Pomades é fácil de lavar, sem deixar resíduos oleosos, sendo hoje a opção mais popular para o cuidado e pentear dos cabelos.

Fixação média
 Acabamento: brilho médio

Benefícios

- » Permite pentear o cabelo repetidamente durante o dia.
- » Não seca, nem deixa o cabelo duro
- » Sem gordura.
- » Fácil de lavar
- » Remove facilmente o cabelo.
- » Não causa acne.



Après-rasage splash After-shaves

La Shaving Co. AFTER SHAVES est une série de lotions après-rasage hypoallergéniques, testées dermatologiquement et non alcoolisées dans des petits emballages soigneusement mélangés pour un soin et un rasage supérieurs de l'homme, en utilisant seulement 100 ingrédients Premium. % naturel, délice avec des notes pures et rafraîchissantes dans chacun de ses arômes.

Avantages:

- » Fournit une hydratation et une nutrition supérieures pour les follicules de la peau et des cheveux sans agents chimiques.
- » Il réduit considérablement la sensation de démangeaisons et de peau sèche.
- » Il réduit considérablement l'irritation et la rougeur de la peau.
- » Ne contient pas d'alcool.
- » Produit hypoallergénique.
- » Diminue l'apparition de l'acné.

A Shaving Co. after-shaves, uma série de loções hipoalergênicas, dermatologicamente testadas e não-alcoólicas, em embalagens pequenas cuidadosamente misturadas para cuidados superior, usando apenas ingredientes premium 100 % natural, delicia-se com notas puras e refrescantes em cada um dos seus aromas.

Benefícios:

- » Proporciona hidratação e nutrição superior para a pele e foliculos pilosos sem agentes químicos.
- » Reduz significativamente a sensação de irritação e pele seca.
- » Não contém álcool.
- » Produto hipoalergênico.
- » Diminui a aparência de acne.

- » Bois de santal
- » Sândalo

100 ml

REF.06376



- » Citrus
- » Citrus

100 ml

REF.06377



- » Lavande
- » Lavanda

100 ml

REF.06378



- » 1888
- » 1888

100 ml

REF.06379



**Huiles pour la barbe**
Óleos para barba

La Shaving Co. BEARD OILS est la première série d'huiles hypoallergéniques et dermatologiquement testées pour les soins de la barbe produites en petits lots soigneusement mélangés pour un résultat supérieur dans le conditionnement et le maintien de la barbe masculine, en utilisant uniquement des huiles essentielles Premium. 100% naturel qui ravira avec des notes pures et rafraîchissantes dans chacun de ses arômes. BEARD OILS est l'un des produits essentiels que tout homme barbu peut posséder.

Avantages:

- » Fournit une hydratation et une nutrition supérieures pour les follicules de la peau et des cheveux sans agents chimiques.
- » Il réduit considérablement la sensation de démangeaisons et de sécheresse dans la barbe. Évitez les pointes fourchues dans la barbe.
- » Il contrecarre efficacement les mauvaises odeurs de manger et de fumer.

A Barbear Co. é a primeira série de óleos para barba hipoalergênicos e dermatologicamente testados produzidos em pequenos lotes cuidadosamente misturados para um resultado superior no condicionamento e manutenção da barba do homem, usando apenas óleos essenciais Premium 100% natural que encanta com notas puras e refrescantes em cada um dos seus aromas. é um dos produtos essenciais que qualquer homem barbado pode possuir.

Benefícios:

- » Proporciona hidratação e nutrição superiores para a pele e folículos pilosos sem agentes químicos.
- » Isso reduz significativamente a sensação de irritação e pele seca.
- » Evite pontas duplas na barba.
- » Efetivamente neutraliza os maus odores (fumar e comida)

- » Lavande
- » *Lavanda*



60 ml

REF.06370

- » 1888
- » 1888

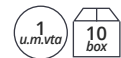

60 ml

REF.06372



Baume à barbe Bálsamo para barba



60 ml

Citrus

REF. 04488

**Wilderness**

REF. 04490

**Woodland**

REF. 04489



Huile de barbe Óleo para barba



30 ml

Citrus

REF. 04485

30 ml

Woodland

REF. 04486

30 ml

Wilderness

REF. 04487



Baume à barbe Mr. Bear Family parfait pour un usage quotidien. L'hydrate, en la rendant plus exubérante, douce et agréable au toucher. Formulé uniquement avec des produits naturels. C'est une cire dure et doit être chauffée avant l'application, en la conservant dans votre poche, en la frottant avec vos doigts ou en la touchant avec le sèche-cheveux.

Bálsamo para barba Mr. Bear Family perfeito para o uso diário. Hidrata tornando mais exuberante, suave e agradável ao tato. Feita apenas com produtos naturais. É uma cera dura e deve ser aquecida antes da aplicação, guardando no bolso, esfregando-a com os dedos ou com um pequeno aquecimento com o secador de cabelo.

Huile à barbe Mr. Bear Family élaborée uniquement avec des huiles naturelles. Elle adoucit et laisse la barbe gérable pour nourrir la peau. Cela aide à éviter les rougeurs et les irritations. Elle hydrate la barbe en la laissant douce, exubérante et facile à coiffer.

Óleo para barba Mr. Bear Family feito apenas à base de óleos naturais. Suaviza e deixa a barba maleável além de nutrir a pele. Ajuda a evitar a irritação. Hidrata a barba deixando-a suave, exuberante e fácil de pentear.

Baume pour moustache Bálsamo para bigode



Le baume à moustache Mr. Bear Family pour embellir et façonner la moustache. Cire dure qui colle bien et laisse la moustache dans la forme désirée. La cire est faite à la main, en utilisant uniquement des ingrédients naturels. Avec du beurre de karité, de la cire d'abeille et des huiles essentielles.

Original

30 ml

REF. 04491

Citrus

30 ml

REF. 04492



Bálsamo para bigode Mr. Bear Family para embelezar e dar forma ao bigode. Cera dura que fixa bem e deixa o bigode com a forma desejada. A cera é feita manualmente, utilizando apenas ingredientes naturais. Com manteiga de Karité, cera de abelha e óleos essenciais.

Wilderness

30 ml

REF. 04493

Woodland

30 ml

REF. 04494





Shampooing à barbe Mr. Bear family Champô para barba mr bear family



Shampooing à la barbe M. Bear Family. Shampooing doux avec des ingrédients naturels pour laver la barbe. Il apaise et hydrate la peau, grâce à ses propriétés anti-irritantes et apporte à la barbe un aspect plus attrayant et exubérant, soulignant également ses 3 arômes agréables.

Champô para barba Mr. Bear Family. Champô suave com ingredientes naturais para lavar a barba. Acalma e hidrata a pele, graças às suas propriedades anti irritantes e dá à barba um aspeto mais atrativo e exuberante, em 3 agradáveis aromas.

250 ml

Citrus
REF. 04559



250 ml

Woodland
REF. 04560



250 ml

Wilderness
REF. 04561



L'huile de rasage Mr bear Family Óleo de barbear Mr bearFamily



30 ml

REF. 04495



À propos de Mr.Bear Family Expositor de Mr.Bear Family



REF. 04680

REF. 04558



1 unité de
chaque référence.

Vide
Vazio

Inclui 1 unidade de
cada referência.

L'huile de rasage Mr. Bear Family pour une expérience de rasage agréable. Fabriquée à partir d'huiles naturelles. Grâce à sa haute densité, la peau ne l'absorbe pas. Elle adoucit la barbe, la rend plus facile à raser, et agit comme un bouclier protecteur pour la peau pendant et après le rasage. Tout cela fait glisser la lame plus facilement sur la peau. Elle aide également à soulager les rougeurs, les irritations, les démangeaisons et la sécheresse de la peau après le rasage.

Óleo de barbear Mr. Bear Family para uma agradável experiência ao barbear. Feito a partir de óleos naturais. Graças à sua elevada densidade a pele não o absorve. Amolece a barba, pelo que a torna mais fácil de barbear, e atua como um escudo protetor para a pele durante e depois do barbear. Tudo isto faz que a lâmina deslize mais suavemente na pele. Não irrita, evita a pele seca depois do barbear.

Baume à lèvres Mr. Bear Family Bálsamo labial Mr. bear Family



15 ml

REF. 04496

Pink grape

15 ml

REF. 04498

Coco

15 ml

REF. 04497

Mint

Lèvres douces et protégées. 100% naturel et fait à la main. Avec des arômes agréables de raisin rose, de menthe et de noix de coco. Il nourrit, protège et adoucit les lèvres dès la première application. Avec de l'huile de coco, de l'huile de jojoba, du beurre de karité, de la cire de carnauba et des huiles essentielles.

Lábios suaves e protegidos. 100% natural, feito à mão. Com agradáveis aromas a Uva, Rosa, Menta e Coco. Nutre, protege e suaviza os lábios desde a primeira aplicação. Com óleo de coco, jojoba, manteiga de karité, cera de Carnaúba e óleos essenciais.



Pierre d'alun 100% naturelle
Pedra de alumínio 100% natural

1 u.m.vta 378 box

75 gr

REF.04220



Coupée à la main, pour apaiser la peau et l'irritation après le rasage.

Cortada à mão, para acalmar a pele e a irritação depois do barbear.

Savon de rasage à la pierre d'alun
Sabão de barbear com alumínio

1 u.m.vta 24 box

100 gr

REF.04219



Savon de rasage à la pierre de l'alun. Sa formule unique 100% à base de Pierre d'Alun et de Beurre de Karité prépare la zone pour le passage du rasoir et fait du rasage un rituel très agréable.

Sabão de barbear com alumínio. A sua fórmula única 100% à base de Pedra de Alumínio e Manteiga de Karité prepara a pele para a passagem da navalha e faz do barbear um ritual muito agradável.

Crayon hémostatique
Lápis hemostático

12 u.m.vta 12 box

12 gr

REF.04218



Granel
Bulk

REF.04218/01

Crayon hémostatique pour le traitement des micro-coupures dans le rasage. Fabriqué avec de l'alun de potassium. Certificat CE. Usage externe et personnel. Il est préparé dans un tube de voyage pratique et sûr pour une utilisation facile.

Lápis hemostático para o tratamento de microcortes feitos ao barbear. Com alumínio de potássio. Certificado CE. Uso externo e pessoal. Embalado num tubular prático e seguro para facilitar a sua utilização.

Kit de rasage osma
Kit barbear osma

1 u.m.vta 1 box

REF.04221



Composé par:

- » Boîte en bois
- » Crayon hémostatique 12 g.
- » Savon de rasage à la pierre d'alun 100 gr
- » Pierre d'alun 75 g
- » Brosse à cheveux en bois

» Composto por

- » Cofre de madeira
- » Lápis hemostático 12 g.
- » Sabão de barbear com alumínio 100 gr
- » Pedra de alumínio 75 g
- » Pincel de madeira



Massage à l'eau de citron régénérant la couche naturelle de la peau
Massagem água de limão, regeneradora da epiderme

1 u.m.vta
8 box

Régénérateur de la couche acide naturelle de l'épiderme de la peau et de la peau. En général, l'acide citronné est efficace contre les boutons et la séborrhée du visage et adoucit la peau. Rasage quotidien sans douleur et apaise instantanément la piqûre du rasage. Tonique astringent Il produit une sensation extraordinaire de fraîcheur et un arôme agréable. Recommandé pour les peaux grasses.
 Solution hydroalcoolique.

Regenerador da epiderme, da em geral, o ácido de limão é eficaz contra a seborréia facial e suaviza a pele. Usar tônico adstringente produz uma sensação extraordinária de frescura e tem um aroma agradável. Recomendado para pele oleosa. Solução hidroalcoólica.



200 ml

REF.04352



180 ml

REF.03866



Massage antesol pour avant et après rasage
Massagem antesol para o antes e depois do barbear

Alantoína
Allantoin

1 u.m.vta
8 box

Massage myolol avantol. Pour avant et après le rasage. Il favorise la régénération des cellules cutanées endommagées et réduit la sensation de douleur. Indiqué pour traiter la peau sèche comme un hydratant. Le résultat est une peau plus lisse et plus saine. Recommandé pour les peaux sèches.
 Solution hydroalcoolique.

Para antes e depois do barbear. Favorece a regeneração das células da pele danificadas e reduz a sensação de dor. Indicado para tratar a pele seca, hidratante. O resultado é uma pele mais suave e saudável. Recomendado para pele seca. Solução hidroalcoólica.



200 ml

REF.04650



180 ml

REF.03867

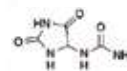

Après rasage (after shave) formule k tonique. Rafrâichissement mentolé
After shave fórmula k tónico. Refrescante com mentol

1 u.m.vta 8 box

Formule après-rasage k. Son action rafraîchissante et tonique aide à soulager la douleur et les irritations. Si délicate que soit votre peau, elle conserve son hydratation et son élasticité naturelle, évitant ainsi son vieillissement prématuré. Recommandé pour les peaux sèches. Solution hydroalcoolique.

Após de barbear. Sua ação refrescante e tônica ajuda a aliviar a dor e a irritação. Não importa quanto delicada seja a sua pele, retém a umidade e a elasticidade natural, prevenindo o envelhecimento prematuro da pele. Recomendado para pele seca. Solução hidroalcoólica.



200 ml

REF.04643



180 ml

REF.03872



Après rasage (after shave) eau balsamique régénérante de la peau
After shave água balsâmica regeneradora da pele

1 u.m.vta 8 box

Excellent régénérateur de peau Irritation apaisante du rasage. Il est fabriqué à partir de substances extraites de romarin, de thym, de lavande et d'autres plantes indiquées pour décongestionner les parties affectées par le frottement, les ecchymoses et après le rasage. Recommandé pour les peaux grasses. Solution hydroalcoolique.

Excelente regenerador de pele. Calma a barba. É feito com substâncias extraídas de alecrim, tomilho lavanda e outras plantas indicadas para descongestionar as partes afetadas. Recomendado para pele oleosa. Solução hidroalcoólica.



200 ml

REF.04642



180 ml

REF.03875



Émulsion pour rasage sans alcool pour massage avant et après rasage
Emulsão para barbear sem álcool para massagem antes e depois do barbear

1 u.m.vta 8 box



200 ml

REF.04587



180 ml

REF.03869

» Roll-on
» Roll-on

75 ml

REF.04887

Indications: se raser sans douleur sans brosse ni savon et pour le massage avant et après le rasage. Pour un rasage parfait des barbes les plus difficiles et des peaux les plus délicates. Un produit aux effets surprenants. Cette émulsion est hautement hydratante, nourrissante, hémostatique, analgésique. Indiqué pour les moustaches et le contour de la barbe. Recommandé pour les peaux sensibles. Solution sans alcool.

Indicações: barbear-se sem dor sem escova ou sabão e pela massagem antes e depois do barbear. Para um barbear perfeito para a barba mais difícil e para a pele mais delicada. Um produto com efeitos surpreendentes. Esta emulsão é altamente hidratante, nutritiva, hemostática, analgésica. Indicado para bigodes e contorno de barba. Recomendado para peles sensíveis. Solução não alcoólica.

Massage extra après rasage
Massagem extra aftershave

1 u.m.vta 8 box

After shave



180 ml

REF.03877

Lotion apaisante de toute sorte d'irritation produite par le rasage. Elle donne à la peau douceur et une agréable sensation balsamique et de fraîcheur, de guérison.

Loção calmante para qualquer tipo de irritação produzida pelo barbear. Dá à pele elasticidade, tonicidade e uma agradável sensação de frescura, cicatrização e balsâmica.

Massage Mentisol
Massagem Mentisol

1 u.m.vta 8 box



180 ml

REF.03878



Il a des propriétés curatives astringentes, il équilibre la fonction des glandes sébacées en évitant l'apparition de boutons sur la peau. Il aide à prévenir les irritations et les infections cutanées. Hémostatique efficace contre les microcoupures de rasage.

Tem propriedades cicatrizantes, adstringentes, equilibra a função das glândulas sebáceas evitando a aparição de borbulhas na pele. Ajuda a prevenir irritações e infeções da pele Hemostática eficaz contra os microcortes do barbear..

Tonique pour le visage - Formule C
Tónico facial Fórmula C

1 u.m.vta 8 box



180 ml

REF.03874



Indiqué pour le soin de la peau, en particulier de la peau grasse. Régénère l'épiderme, rafraîchit et répare la peau après le rasage hydratant, relaxant, apaisant.Recommandé pour les peaux grasses.Une solution hydroalcoolique.

Indicado para o cuidado da pele, especialmente para peles oleosas. Regenera a epiderme, refresca e repara a pele depois do barbear hidratante, relaxante e calmante. Recomendado para peles oleosas, solução hidroalcolica..

Massage facial Plastic Shaves
Massagem facial Plastic Shaves

1 u.m.vta 8 box



180 ml

REF.03871



Pour obtenir un rasage quotidien sans douleur ni gêne. Très approprié également pour neutraliser les piqûres de moustiques et autres diptères. Il améliore la texture et le ton de la peau et l'aspect général. Recommandé pour les peaux sensibles. Une solution hydroalcoolique.

Para conseguir barbear-se diariamente sem dor e sem problemas. Apropriado também para neutralizar picaduras de mosquitos e outros insetos. Melhora a textura, o tom da pele e o aspeto em geral. Recomendado para peles sensíveis. Solução hidroalcolica.

Massage électrique Massagem electric

1 u.m.vta
8 box

REF.03868



180 ml



Lotion indiquée pour lubrifier la peau et la machine électrique avant le rasage.

Permet le glissement de la machine pour réduire le frottement et l'irritation de la peau. Solution alcoolique.

Loção indicada para lubrificar a pele e a máquina elétrica antes do barbear.

Permite que a máquina deslize melhor, reduzindo a fricção e a irritação da pele. Solução hidroalcoólica.

Massage myrsol blue after shave Massagem blue

1 u.m.vta
8 box

REF.03873



180 ml

Myrsol-After shave blue. Le complément parfait après le rasage pour ses propriétés toniques et apaisantes. Excellent pour les affections cutanées: inflammation, irritation, déshydratation. Il fournit de la fraîcheur, de la tonicité et de la vitalité. Il a une fragrance distinctive de longue durée en contact avec la peau, recommandé pour les peaux sèches. Solution hydroalcoolique.

Myrsol-After shave blue. O complemento perfeito para depois do barbear, pelas suas propriedades tónicas e calmantes.

Excelente para problemas de pele: inflamação, irritação, desidratação. Dá frescura, tonicidade e vitalidade. Possui uma fragrância distinta e duradoura ao contato com a pele, recomendado para peles secas. Solução hidroalcoólica.



En hommage au fondateur de la marque Em homenagem ao fundador da marca



1 u.m.vta
8 box

180 ml

REF.04701

Massage Myrsol de Don Miguel 1919. Après rasage, formule réinventée avec des propriétés qui réparent la peau après le rasage. fragrance spéciale et élégante.

Myrsol massagem Don Miguel 1919. After shave, fórmula reinventada com propriedades que reparam a pele após o barbear. Fragrância especial e elegante



1 u.m.vta
6 box

235 ml

REF.04702

Eau de Cologne Myrsol de Don Miguel 1919. Parfum à base de jasmin résolument masculin.

Myrsol colônia Don Miguel 1919. Fragrância à base de jasmim definitivamente masculina.



Édition spéciale don miguel Edição especial don miguel

1 u.m.vta
12 box

150 ml

REF.04802



Crème à rasage Myrsol de Don Miguel 1919 avec de la lanoline à appliquer avec un pinceau.

Myrsol creme de barbear Don Miguel 1919 com lanolina para aplicar com pincel

Jasmin · Jasmine

Savon liquide pour rasage brosse
Sabão líquido para barbear com pincel

» Crème à raser à la lanoline, à raser au pinceau
» Creme de barbear com lanolina, para barbear com escova

1 u.m.vta 8 box
200 ml
REF.03876



1 u.m.vta 12 box
1000 ml
REF.06242



Lotion capillaire tonifiante myrsol
Loção capilar revitalizante myrsol

» Régénératrice du cuir chevelu, anti-pelliculaire et
» anti-séborrhéique. PAS DE RINÇAGE

» Regeneradora do couro cabeludo, anticaspas e anti seborreica. SEM ENXAGUAR

1 u.m.vta 6 box
235 ml
REF.04644



1 u.m.vta 12 box
1000 ml
REF.04645



Matches hémostatiques 20 services
Fosforos hemostáticos 20 serviços1
u.m.vta) 16
box

- » Formule 100% naturelle, facile à utiliser
- » Antiseptique
- » Boîte de présentation par unités
- » 50 pochettes par boîte
- » 20 allumettes dans chaque livret
- » 300 gr
- » Fabriqué en Chine

- » Expositor 50 caixitas. 20 unidades cada caixita
- » Fórmula 100% natural
- » 300 gr
- » Fabricado na PRC

REF.06194

**Pomade THE LEGENDS**
Pomada THE LEGENDS1
u.m.vta) 12
box

120 ml

REF.06195



Facile à appliquer, remodeler, facilement enlever, fixation forte

- » Fixation forte - pour toute la journée
- » Odeur douce et propre
- » Consistance légère
- » Couleur claire
- » Luminosité moyenne
- » Convient à tous les styles
- » Facile à appliquer
- » Pot en plastique blanc
- » Style vintage
- » 4 oz / 120 ml
- » Fabriqué dans l'UE

Fácil de aplicar, remodelar, remover, fixação forte

- » fixação forte - durante todo o dia
- » Cheiro suave e limpo
- » Consistência de luz
- » Cor clara
- » Brilho médio
- » Adequado para todos os tipos de estilos
- » Fácil de aplicar
- » Jarra de plástico branco
- » Estilo vintage
- » 4 oz / 120 ml
- » Produzido na UE

Gel THE LEGENDS
Gel THE LEGENDS1
u.m.vta) 12
box

220 ml

REF.06197



Produit "old school" fixation forte, nutritive, restylante.

- » Fixation forte - toute la journée
- » Parfum
- » Consistance lisse
- » Couleur rouge semi-transparente.
- » Brillance moyenne sur cheveux mouillés
- » Mat moyen sur cheveux secs
- » Toutes sortes de styles
- » Pot en plastique blanc
- » Style vintage
- » 4 oz / 220 ml
- » Produit dans l'UE

Produto "old school" forte, nutritivo, restyling fixação.

- » Fixação forte - o dia todo
- » Fragrância
- » Consistência suave
- » Cor vermelha semitransparente.
- » Brilho médio no cabelo molhado
- » Meio fosco no cabelo seco
- » Todos os tipos de estilos
- » Estilo vintage
- » 4 oz / 220 ml
- » Produzido na UE

Shampooing prévention anti-chute
Champô prevenção da queda



- » Shampooing formulé spécifiquement pour lutter contre la chute des cheveux, car il combine des protéines et des bionutriments d'origine végétale, qui agissent comme des décongestionnants et des revitalisants, tout en évitant ainsi les irritations.
- » Nettoie en profondeur, en éliminant les graisses qui se forment sur le cuir chevelu, permettant ainsi aux nouveaux cheveux de se développer sans entrave.
- » Les cheveux sont doux, brillants et soyeux.

» *Champô formulado especificamente para combater a queda de cabelo, visto que combina proteínas e bio-nutrientes de origem vegetal, que atuam com descongestionante e revitalizante evitando assim a irritação.*

» *Limpa em profundidade, eliminando a oleosidade que se forma no couro cabeludo permitindo assim que o cabelo cresça naturalmente.*

» *O cabelo fica suave, brilhante e sedoso.*



1 u.m.vta 12 box

1000 ml

REF.03566

1 u.m.vta 6 box

400 ml

REF.03553

Ampoules
Ampolas

Les meilleurs nutriments pour le cuir chevelu et sont des protéines d'origine végétale. Ils améliorent l'absorption de ceux-ci et favorisent l'oxygénation du follicule pileux, en réduisant ainsi la perte de cheveux. Les nutriments végétaux agissent également comme décongestionnants et revitalisants, en empêchant ainsi l'irritation. La kératine répare et fortifie les cheveux, leur donnant du volume et de la brillance.

Os melhores nutrientes para o couro cabeludo são as proteínas de origem vegetal. Aumentam a absorção destes e favorecem a oxigenação do folículo piloso, diminuindo assim a queda do cabelo. Os nutrientes vegetais também atuam como descongestionantes e revitalizantes, evitando assim a irritação. A queratina repara e fortalece o cabelo, dando-lhe volume e brilho.

- » 12 ampoules prévention anti-chute
- » Shampooing prévention anti-chute 400 ml

- » 12 ampolas prevenção queda
- » Champô de prevenção 400 ml

1 u.m.vta 6 box

REF.03550

- » 12 ampoules prévention anti-chute
- » 10 ml chaque flacon

- » 12 ampolas prevenção queda
- » 10 ml cada frasco

1 u.m.vta 6 box

12 u

REF.03551



Fibre capillaire

Fibra capilar



22 gr

- » Avec distributeur
- » Pour hommes et femmes. Idéales pour la perte de densité capillaire. Elles dissimulent les zones ayant peu de cheveux, rapidement et naturellement
- » Elles adhèrent aux cheveux et leur apportent volume et épaisseur
- » Faciles à appliquer, en agitant le pot au-dessus de la zone d'application
- » Disponibles en 6 couleurs : Noir, Châtain Foncé, Châtain Moyen, Châtain Clair, Blond Foncé et Gris Clair qui s'adaptent à la couleur naturelle des cheveux

- » Para homem e mulher. Ideal para a perda de densidade capilar. Dissimula as zonas com pouco cabelo, de forma rápida e natural
- » Adere ao cabelo conferindo-lhe mais volume e espessura
- » Aplica-se facilmente, agitando o frasco em cima da zona de aplicação
- » Disponível em 6 cores: cor preto, Castanho Escuro, Castanho Médio, Castanho Claro, Louro Escuro e Cinzento Claro que se adaptam à tonalidade da cor natural do cabelo
- » Com dispensador



Noire · Preto

REF.06436/50

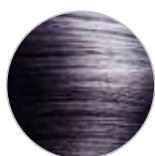

Gris clair · Cinza claro

REF.06436/72



Blond foncé · Loiro escuro

REF.06436/66

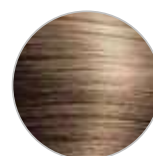

Brun foncé · Castanho escuro

REF.06436/67

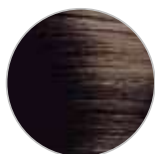

Châtaignier moyen · Castanha média

REF.06436/76

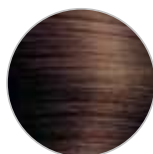

Châtain clair · Castanho claro

REF.06436/65

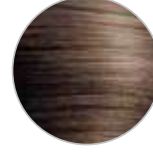

Pulvérisateur de fibres capillaires

Pulverizador de fibra capilar



REF.07208

- » Facile d'utilisation
- » Permet une distribution plus uniforme des fibres capillaires sur les zones spécifiques.
- » Permet aux fibres d'adhérer aux cheveux naturels beaucoup plus facilement. Moins de produit est nécessaire pour obtenir le look souhaité.
- » Facile à conserver

MODE D'EMPLOI :

Verser les fibres capillaires dans la bouteille en verre et positionner le pulvérisateur pour les pulvériser. Appuyer pour cela la pompe de haut en bas.

- » Fácil de usar
- » Permite uma distribuição mais uniforme das fibras capilares em áreas específicas.
- » Ele permite que as fibras se fixem em seu cabelo natural com muito mais facilidade. É necessária menos quantidade de produto para obter a aparência desejada.
- » Fácil de guardar

COMO USAR:

Despeje as fibras capilares no frasco de vidro e instale o atomizador para borrifá-las. Pressione a bomba para cima e para baixo para este propósito.

NEW



Laque fibre capillaire

Laca fibra capilar



Pour une fixation et une fixation maximales des fibres

100 ml

REF.06649

Para máxima fixação das fibras



Présentoir fibres capillaires (en cadeau)

Expositor fibras capilares (de oferta)



Il inclue 6 tons de fibres capillaires + laque de fixation

- Réf. 06436/50 Noir 22 g.
- Réf. 06436/72 Gris clair 22 g.
- Réf. 06436/66 Blond foncé 22 g.
- Réf. 06436/67 Châtain foncé 22 g.
- Réf. 06436/76 Châtain moyen 22 g.
- Réf. 06436/65 Châtain clair 22 g.
- Réf. 06649 Laque fixation fibres capillaires 100 ml.

100 ml

REF.07801

NEW

- » Inclui 6 tons fibras capilares + laca fixação
- » Ref. 06436/50 Preto 22 g.
- » Ref. 06436/72 Cinzento claro 22 g.
- » Ref. 06436/66 Louro escuro 22 g.
- » Ref. 06436/67 Castanho escuro 22 g.
- » Ref. 06436/76 Castanho médio 22 g.
- » Ref. 06436/65 Castanho claro 22 g.
- » Ref. 06649 Laca fixação fibras capilares 100 ml.



Roll-on de cire pour homme
Roll-on cera homem



Le système d'épilation au rouleau est optimal pour les professionnels qui cherchent à obtenir de meilleurs résultats. Les résines avec lesquelles nous fabriquons les cires peuvent être utilisées à une température plus élevée que la cire de basse fusion, avec l'avantage d'être appliquées au moyen d'une bande plus mince. Ainsi, la cire refroidit presque instantanément et la sensation de chaleur dans la peau est minimisée. La cire s'enlève facilement avec les bandes hygiéniques. Prix d'escalade combinables page 556-557-558.

O sistema roll-on de depilação é ideal para aqueles profissionais que buscam obter os melhores resultados. As resinas com as quais fabricamos as ceras podem ser usadas a uma temperatura mais elevada do que a cera de baixo ponto de fusão, com a vantagem de serem aplicadas por meio de uma tira mais fina. Assim, a cera esfria quase instantaneamente e a sensação de calor na pele é minimizada. A cera é facilmente removida com as tiras higiênicas. Página de preços de escalada combinável 556-557-558.



100 ml

REF.03858



07

Mobilier et décoration

MOBILIÁRIO
E DECORAÇÃO

*Enseigne barbier, fauteuil, bac à shampoing,
chaises enfants, miroirs, et chariots coiffure...*

*Pólo de barbeiro, poltronas de barbeiro, lavató-
rios, cadeiras infantis, espelhos e carrinhos ...*

Enseigne de barbier

Pólos barbeiro

Avec cable
Com cabo



L'origine du poste de barbier rouge blanche remonte à l'époque médiévale où les barbiers ont opéré leurs clients. Ainsi que des extractions dentaires. Le poteau avait à l'origine un bassin en bronze en haut, représentant le conteneur où les sangsues étaient stockées, et un autre en bas, faisant allusion au destinataire recevant le sang. Le poteau lui-même symbolise le bâton ou le bâton que le patient a saisi pendant la procédure pour faciliter la circulation sanguine. C'est pourquoi le pôle barbier est associé aux services offerts, dont la sangria. Historiquement, il était représenté avec des bandages sanglants enroulés autour d'un poteau.

A origem do posto do barbeiro vermelho-branco remonta à era medieval, onde os barbeiros realizavam cirurgias em seus clientes. Bem como extrações dentárias. O poste originalmente tinha uma bacia de bronze na parte superior, representando o recipiente onde as sanguessugas estavam armazenadas, e outra na parte inferior, aludindo ao receptor que recebia o sangue. O próprio bastão simboliza o bastão que o paciente agarrou durante o procedimento para facilitar o fluxo sanguíneo. Por isso, o poste de barbeiro está associado aos serviços oferecidos, entre eles a sangria. Historicamente, era retratado com bandagens sangrentas enroladas em um poste.

REF. 04578

REF. 04745



- » Potencia: 13 W
- » Vitesse d'essorage: 50-60 RPM
- » Enseigne de barbier noir lumineux et rotatif Ø 20 cm
- » Tension 220-240V~
- » Fréquence: 50/60 Hz

- » Potência: 13W
- » Velocidade de giro: 50-60RPM
- » Option de lumière et / ou de rotation
- » Pólo barbeiro preto luminoso e rotativo Ø 20 cm
- » Opção de luz e/ou rotação.
- » Voltagem: 220-240V ~
- » Frequência: 50/60 Hz



- » Potencia: 12 W
- » Vitesse d'essorage: 50-60 RPM
- » Vintage enseigne de barbier noire
- » Option de lumière et / ou de rotation
- » Tension: 220-240V~
- » Fréquence: 50/60 Hz

- » Potência: 12W
- » Velocidade de giro: 50-60RPM
- » Pólo barbeiro preto vintage
- » Opção de luz e/ou rotação.
- » Voltagem: 220-240V ~
- » Frequência: 50/60 Hz

REF. 04744

REF. 04743

REF. 04946



- » Potencia: 13 W
- » Vitesse d'essorage: 50-60 RPM
- » Enseigne de barbier chromé avec cadran lumineux.
- » Option de lumière et / ou de rotation
- » Tension: 220-240V~
- » Fréquence: 50/60 Hz

- » Potência: 13 W
- » Velocidade de giro: 50-60RPM
- » Pólo barbeiro cromado com esferaluminosa
- » Opção de luz e/ou rotação.
- » Voltagem: 220-240V ~
- » Frequência: 50/60 Hz



- » Potencia: 17 W
- » Vitesse d'essorage: 50-60 RPM
- » Enseigne de barbier chrome petit modele
- » Option de lumière et / ou de rotation
- » Tension: 220-240V~
- » Fréquence: 50/60 Hz

- » Potência: 17 W
- » Velocidade de giro: 50-60RPM
- » Pólo barbeiro chromed pole small
- » Opção de luz e/ou rotação.
- » Voltagem: 220-240V ~
- » Frequência: 50/60 Hz



- » Potencia: 13 W
- » Vitesse d'essorage: 50-60 RPM
- » Enseigne de barbier chromé de grande taille
- » Option de lumière et / ou de rotation
- » Tension: 220-240V~
- » Fréquence: 50/60 Hz

- » Potência: 13 W
- » Velocidade de giro: 50-60RPM
- » Pólo barbeiro cromado grande
- » Opção de luz e/ou rotação.
- » Voltagem: 220-240V ~
- » Frequência: 50/60 Hz

Fauteuil de coiffure **SPRINGFIELD** Cadeira de barbeiro **SPRINGFIELD**



Le nouveau fauteuil de barbier Springfield est conçu dans un style moderne mais sans perdre sa fonctionnalité et ses lignes classiques. La chaise a une pompe hydraulique qui nous permet de soulever et d'abaisser le siège, afin que nous puissions placer notre client à la hauteur qui convient le mieux à notre travail. La mousse du dossier a une épaisseur de 6 cm et l'assise de 11 cm cela fera que notre client s'adaptera bien au fauteuil et sera très confortable. L'appuie-tête est amovible et réglable afin que nous puissions l'adapter à chaque travail. Le dossier de la chaise peut être incliné de 108 degrés, tandis que nous inclinons le dossier, la structure du repose-pieds sera également inclinée pour donner un maximum de confort.

A nova poltrona de barbeiro de Springfield foi projetada em estilo moderno, mas sem perder a funcionalidade e as linhas clássicas. A cadeira possui uma bomba hidráulica que permite elevar e abaixar o assento, para que possamos colocar nosso cliente na altura que melhor se adequa ao nosso trabalho. A espuma do encosto tem uma espessura de 6 cm e o assento de 11 cm, isso fará com que nosso cliente se adapte bem à poltrona e seja muito confortável. O apoio de cabeça é removível e ajustável para que possamos adaptá-lo a cada trabalho. O encosto da cadeira pode ser inclinado em 108 graus, enquanto inclinamos o encosto, a estrutura do apoio para os pés também será inclinada para proporcionar o máximo conforto.



REF.06955



Fauteuil de coiffure **STAFFORD** Cadeira de barbeiro **STAFFORD**



Le nouveau fauteuil de barbier Stafford est conçu avec des lignes et des finitions rétro. Il est considéré comme un fauteuil «vintage» car il mélange l'acier et le tissu avec un effet usé. De qualité dernière génération, il est équipé d'une pompe hydraulique pour régler la hauteur du siège. Le repose-pieds est pivotant et le dossier est inclinable. L'appuie-tête est amovible et également réglable pour l'adapter à chaque travail. Disponible en noir et marron.

Inclinaison d'environ 120 degrés.

A nova poltrona de barbeiro Stafford foi projetada com linhas e acabamentos retrô. É considerada uma poltrona "vintage", pois mistura aço e tecido com um efeito desgastado. Com qualidade de última geração, é equipado com uma bomba hidráulica para ajustar a altura do assento. O apoio para os pés é giratório e o encosto reclinável. O apoio de cabeça é removível e também ajustável para adaptá-lo a cada trabalho. Disponível nas cores preto e marrom.

Inclinação de aproximadamente 120 graus.



REF.06956/50

REF.06956/69

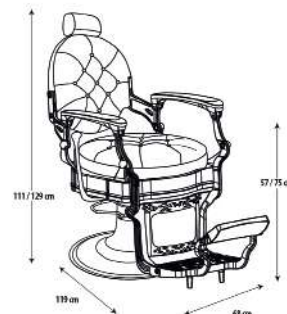

Fauteuil de coiffure VIGOR

Cadeira de barbeiro VIGOR

1 u.m.vto
1 box



Le nouveau fauteuil de coiffure Vigor est conçu avec un style moderne mais sans perdre sa fonctionnalité et ses lignes classiques. Le fauteuil est équipé d'une pompe hydraulique qui vous permet de soulever et d'abaisser le siège et de placer ainsi le client à la hauteur convenable. La mousse du dossier a une épaisseur de 13,5 cm et celle de siège est de 11,5 cm, ce qui permettra au client de bien s'adapter au fauteuil et se mettre à l'aise. L'appui-tête est amovible et réglable de sorte qu'il peut être adapté à chaque travail. Le dossier du fauteuil peut être incliné à 130°, en même temps que le dossier est incliné, la structure du repose-pieds s'inclinera également pour donner un maximum de confort.

A novo cadeira de barbeiro Vigor está concebido com um estilo moderno, mas sem perder a sua funcionalidade e linhas clássicas. O cadeira tem uma bomba hidráulica, a qual permite subir e baixar o assento e assim poderá situar o cliente à altura que melhor se adapte ao trabalho. A espuma do encosto tem uma espessura de 13,5 cm e a do assento é de 11,5 cm, isto fará com que o cliente se adapte bem ao assento e se encontre muito cómodo. O repousa-cabeças é extraível e ajustável, portanto, pode adaptar-se a cada trabalho. O encosto do assento pode ser inclinado 130°, quando isso é feito, o apoia-pés também se inclinará para dar o máximo conforto.



REF.04888

REF.04888/73



Fauteuil de coiffure RÉTRO

Cadeira de barbeiro RETRO

1 u.m.vto
1 box



Le nouveau fauteuil de coiffure rétro a été fabriqué avec les meilleurs matériaux, le design est inspiré par le style vintage, mais sans oublier le confort lors de la conception. Le fauteuil a une pompe hydraulique. ce qui nous permet de soulever et d'abaisser le siège, de cette façon nous pouvons placer notre client à la hauteur convenable. La mousse du dossier est de 11,5 cm et le siège a une épaisseur de 13,5 cm, cela permettra à notre client de bien s'adapter au fauteuil et d'être très à l'aise. L'appui-tête est amovible et réglable et nous pouvons l'adapter à chaque client. Le dossier du fauteuil peut être incliné à 120°, en même temps que nous inclinons le dossier, la structure du repose-pieds s'inclinera également pour donner le maximum de confort.

O novo cadeira de barbeiro retro, foi fabricado com os melhores materiais, o design está inspirado no estilo vintage, mas sem esquecer a comodidade na hora de o conceber. O cadeira tem uma bomba hidráulica, a qual nos permite subir e baixar o assento, desta forma poderemos situar o cliente à altura que melhor se adapte ao trabalho. A espuma do encosto tem uma espessura de 11,5 cm e a do assento tem 13,5 cm, isto fará com que o nosso cliente se adapte bem ao assento e se encontre muito cómodo. O repousa-cabeças é extraível e ajustável e podemos adaptá-lo a cada cliente. O encosto do cadeira pode ser inclinado a 120°, quando isso é feito, a estrutura do apoia-pés também se inclinará para dar o máximo conforto.



REF.04889

REF.04889/73

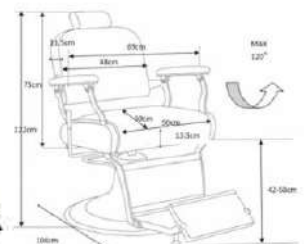

Fauteuil de coiffure classic

Cadeira de barbeiro classic



Nouveau fauteuil de coiffure CLASSIC avec des lignes classiques et des finitions de dernière génération. Il est équipé d'une pompe hydraulique pour régler la hauteur du siège. Le repose-pieds est rotatif et le dossier est incliné pour offrir un maximum de confort au client. La mousse du dossier a une épaisseur de 2,5 cm alors que celle du siège est de 7,5 cm, ce qui permettra au client de bien s'adapter à la chaise et se sentir très à l'aise. Aussi l'appui-tête est amovible et réglable pour l'adapter à chaque travail. Disponible en trois couleurs noir, bordeaux et vert

REF.06087/50

REF.06087/73

REF.06087/62

Nova cadeira de barbeiro CLASSIC com linhas clássicas e acabamentos de última geração. Está dotado de bomba hidráulica para regular a altura do assento. O apoio-pés é giratório e o encosto reclinável para dar o máximo conforto ao cliente. A espuma do encosto tem uma grossura de 2,5 cm e a do cadeira é de 7,5 cm, isto fará com que o cliente se adapte bem ao assento e se sinta muito cómodo. O repouso-cabeças é extraível e ajustável a diferentes trabalhos. Disponível em três cores; preto, granada e verde.



FAUTEUIL barbier noir

CADEIRA BARBEIRO cor preto



REF. 03628

- » Pivote à 360°
- » Largeur du bras au bras 57 cm
- » Tête 19 x 13 cm
- » Dossier 51 x 41 cm
- » Inclinaison 130°

- » Gira a 360°
- » Largura de braço a braço 57 cm
- » Cabeçal 19 x 13 cm
- » Encosto 51 x 41 cm
- » Reclinável 130°



Fauteuil barbier PERSONNALISÉ
Cadeira barbeiro hidráulica PERSONALIZÁVEL



REF.04508/01

**PERSONNALISEZ VOTRE FAUTEUIL**

- » 1. DÉCIDEZ LA COULEUR DE LA BASE
- » 2. CHOISISSEZ LA COULEUR DU SIÈGE

- » Structure de la chaise : Fonte d'aluminium
- » Les pièces chromées sont en bronze et en fer
- » La structure sur laquelle se trouve le rembourrage est faite de pin
- » Certificats de mousse et de revêtements
- » Base recouverte de polyester peint (même système que les voitures)

PERSONALIZE A SUA cadeira

- » 1. DECIDA A COR DA BASE
- » 2. ESCOLHA A COR DO cadeira

- » Estrutura do assento: Alumínio fundido
- » As peças cromadas são em bronze e ferro
- » A estrutura sobre a qual se encontra o tapete é de pinho
- » Espuma e revestimentos Certificados
- » Base coberta de poliéster pintado (Mesmo sistema que os carros)

Fauteuil basculant Cadeira basculante



- » Inclinação 130° / Hydraulique
- » Largeur du bras au bras: 57 cm
- » Tête de chaise d'Anchua: 19 cm
- » Tête amovible avec une position
- » Dossier 51 x 41 cm
- » Hauteur de la tête: 13 cm
- » Distance entre le dossier et la tête
14 cm
- » Poids: 32,5 kg

- » Reclinável 130° / Hidráulica
- » Largura do braço ao braço: 57 cm
- » Largura de cabeça da cadeira: 19 cm
- » Cabeça removível com uma posição
- » Encosto 51 x 41 cm
- » Altura da cabeça: 13 cm
- » Distância entre o encosto e a cabeça
14 cm
- » Peso: 32,5 kg



REF. 02975/50

Fauteuil barbier TRADITIONAL Cadeira de barbeiro TRADITIONAL



Le nouveau fauteuil de coiffure TRADITIONAL a été fabriqué comme un fauteuil sobre et maniable, avec un style très vintage, sans oublier le confort. Il est équipé d'une pompe hydraulique pour ajuster la hauteur de l'assise et du dossier inclinable pour donner un maximum de confort au client. La mousse du dossier a une épaisseur de 9 cm et le siège de 10 cm, ce qui permettra au client de bien s'adapter à la chaise et se sentir très à l'aise. L'appui-tête est amovible et réglable à différentes hauteurs. Il a également un repose-pieds confortable.

A nova cadeira de barbeiro TRADITIONAL foi fabricada como uma cadeira sóbria e fácil de manejar, de estilo muito vintage, sem esquecer a comodidade. Está dotada de bomba hidráulica para regular a altura do cadeira do encosto reclinável para dar o máximo conforto ao cliente. A espuma do encosto tem uma grossura de 9 cm e do cadeira de 10cm, isto fará que o cliente se adapte bem ao cadeira e se sinta muito cómodo. O repouso-cabeças é extraível e ajustável a diferentes alturas. Também tem um cómodo repouso-pés.

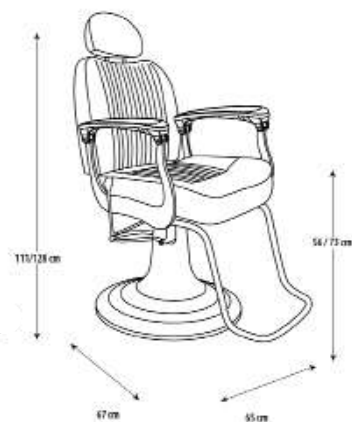

REF.06089/50

Bac lavage TRADITIONAL Rampa de lavagem tRADITIONAL



Le lave-tête TRADITIONAL suivant la ligne du fauteuil de coiffure TRADITIONAL (Ref.06089 / 50) a été fabriqué comme un lave-tête sobre et de style très vintage, sans oublier le confort. Complétez le design de votre salon avec ce lave-tête !

O lava-cabeças TRADITIONAL seguindo a linha do assento de barbeiro TRADITIONAL (Ref.06089/50) foi fabricado como um lava-cabeças sóbrio e de estilo muito vintage, sem esquecer a comodidade. Complete o design do seu salão com este lava-cabeças!



REF.06090/50

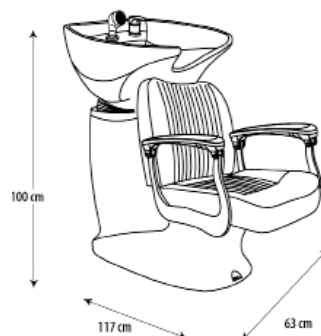

Bac lavage STAFFORD Rampa de lavagem STAFFORD



Le fauteuil Stafford, suivant la ligne du fauteuil de barbier «traditionnel» (référence 06089/50) suit également l'esthétique du lavabo «traditionnel» mais à la différence que le lavabo Stafford se caractérise par sa fabrication en acier et ont une finition usée «vintage»

O ramopa de lavagem Stafford, seguindo a linha de cadeira de barbeiro "tradicional" (referência 06089/50) também segue a estética do lavatório "tradicional", mas com a diferença de que o lavatório Stafford é caracterizado por ser feito de aço e tenha um acabamento «vintage» desgastado no assento.



REF.06957/50



REF.06957/69

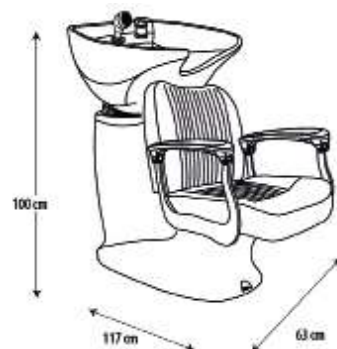

Bac lavage STIL
Rampa de lavagem STIL



- » Appui-bras et télécommande chromés.
- » Tuile en céramique et base fibre de verre.
- » Assise coulissante.
- » Base longue 76 cm
- » Largeur du siège 48 cm
- » Dossier haut 41 cm
- » Céramique 57x50x20cm
- » Hauteur totale 95 cm

- » Apoia-braços e comando cromados.
- » Telha de cerâmica e base fibra de vidro
- » Assento deslizável.
- » Largura base 76 cm
- » Largura assento 48 cm
- » Altura encosto 41 cm
- » Cerâmica 57x50x20cm
- » Altura total 95 cm

●
 REF. 02841

●
 REF. 02841/54

○
 REF. 02841/58

* Pièces de rechange disponible
 *Peças de reposição disponíveis



Chaises pour enfants

Assentos para crianças



Chaises pour enfants, de haute qualité, en métal et style vintage. C'est un concept nouveau et révolutionnaire conçu pour que l'expérience d'aller au salon de coiffure soit agréable et sans drames. karts à pédales pour les enfants qui fonctionnent si elles sont démontées du support. Lumières décoratives, sans klaxon et ceinture de sécurité. Lorsque vous tournez le volant, les roues avant tournent.

Assentos para crianças, de grande qualidade, fabricadas em metal e com estilo vintage. Trata-se de um conceito novo e revolucionário, pensado para que a experiência de ir ao cabeleireiro seja agradável e livre de dramas. Carros com pedais que funcionam desmontados do suporte. Luzes decorativas, sem apito e cinto de segurança. Ao girar o volante movem-se as rodas dianteiras.



24 kg

REF.04728



26,8 kg

REF.04727



Chaise spéciale pour enfants Cadeira especial para crianças

REF.02733



Coussins spéciaux pour enfants Almofadas especiais para crianças



Nous avons également des coussins spéciaux adaptés à toutes les chaises de coiffure qui permettent un travail plus confortable au professionnel, car ils élèvent l'enfant à la bonne hauteur.

Também dispomos de almofadas especiais aptos para qualquer salão de cabeleireiro que permitem um trabalho mais cómodo ao profissional, já que elevam a criança à altura idónea.



REF.04506/50



REF.04506/58



REF.04506/59



REF.04506/60



REF.04506/69



Coussins spéciaux pour enfants Almofadas especiais para crianças



REF.07329/50



Coussins spéciaux pour enfants Almofadas especiais para crianças



REF.03939



Coiffeuse murale barbier Espelho de pared barber



REF.06091

Le miroir mural BARBER, de style vintage, est fonctionnel et pratique pour que votre étagère supporte les objets que vous voulez. Apportez une touche "Old School" à votre salon!

O espelho de parede BARBER, estilo vintage, é funcional e prático pelas suas estantes para apoiar os objetos que desejar. Dé um toque da "old school" ao seu salão!



Coiffeuse rustique BARBER LINE Espelho rústico BARBER LINE



REF.06670

Coiffeuse en résine polyuréthane à base de mdf Matériau avec de meilleures propriétés que le bois en termes de résistance et de stabilité, ignifuge auto-strié et classement antibactérien. Finition en bois rustique avec deux pièces décoratives imitant le fer. Rustique en noir. Toucher boisé, imitation parfaite.

Espelho fabricado em resina de poliuretano com base em mdf, material com as melhores propriedades que a madeira em relação à sua resistência e estabilidade e com qualificação ignífuga auto-extinguível e antibacteriana. Acabamento em madeira rústica com duas peças ornamentais que imitam o ferro e na cor preta. Tem um tato similar à madeira, imitação perfeita. Ideal para apoiar sobre qualquer superfície. Dispõe de uma base que lhe dá estabilidade.



Chariot de coiffure en bois et métal
Carrinho barbeiro madeira e metal

REF.04698/54

Bidon de CAPTAIN COOK
Bidão CAPTAIN COOK

58 cm



88 cm

REF.06054

Comptoir de réception en bois et métal à effet miroir
Desk recepcao de madeira e metal efeito espelho



Avec compartiments intérieurs en bois pour le stockage et l'étagère
 Com compartimentos de madeira interiores para armazenamento e prateleira

REF.03935



Canapé d'attente 3 places
Sofá de espera 3 lugares



» En skai
 » Em pele ecológica

REF.03950



Meuble coiffure de réception en bois de chêne earth Desk recepção carvalho earth

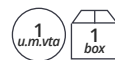

- » Laminé en graphite
- » Avec étagères réglables et 1 tiroir

- » Laminado em grafite
- » Com prateleiras ajustáveis e 1 gaveta

REF.04518/50

REF.04518/65

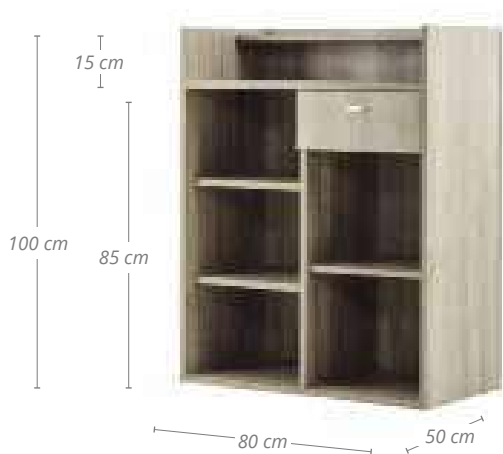

REF.04518/58

REF.04518/72

Rouleau 100 protections fauteuil Rolo 100 protetor cadeira

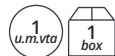

REF.07239



NEW

- » Tenez les germes éloignés de vos fauteuils. Désinfection rapide et facile : en quelques secondes, retirez la housse du fauteuil et jetez-la. Elle s'adapte à la plupart des fauteuils à dossier.
- » 65+16 x 150 cm / 0,025 mm

- » Mantenha os germes longe dos seus assentos. Desinfecção rápida e fácil: em questão de segundos, retire a capa protetora do assento e deite fora. Adapta-se à maioria das cadeiras com encosto.
- » 65+16 x 150 cm / 0,025 mm



Douche avec support
Chuveiro com suporte1
u.m.vta 20
box

REF.03004

**Kit de douche adaptable**
Chuveiro adaptável1
u.m.vta 10
box

REF.01960

**Mitigeur mono commande pour bac à douche**
Mono-comando para lava-cabeças1
u.m.vta 25
box

REF.02837

**Pommeau de douche ionique**
Cabeça chuveiro iônico1
u.m.vta 6
box

REF.03750

Économie d'eau
Meilleure qualité de l'eau.Poupa água.
Melhora a qualidade da água.**Étagère rangement de serviettes**
Organizadores para pendurar toalhas1
u.m.vta 6
box

REF.04378

**Conteneur de serviettes**
Contentor toalhas1
u.m.vta 4
box

REF.03159

» Avec des roues
Housse conteneur
lavable La structure
est en acier
inoxydable» Com rodas
» Bolsa contentora
lavável
» Estrutura de aço
inoxidável
» Stainless steel
structure.

08

Accessoires

ACESSÓRIOS

*Papier protecteur, vêtement barbier,
pulvérisateur, valises, hygiène...*

*Papel protetor, vestuário barbeiro,
pulverizador, malas, higiene...*



Le papier cou est un classique dans le salon de coiffure pour éviter les démangeaisons dans le cou et que les poils peuvent être tendus à l'intérieur.

A papel pescoço é um clássico na barbearia para evitar coceira no pescoço e para que os pelos possam entrar.

Pack 5 rouleaux papier de cou Barber Line

Pack 5 rolos papel pescoço Barber Line



REF. 06596

REF. 06927

REF. 04651



- » 80 services
- » Noir
- » Colle blanche

- » 80 utilizações
- » Preta
- » Cola branca



- » 80 services
- » Noir
- » Colle blanche

- » 80 utilizações
- » Preta
- » Cola branca



- » 100 services
- » Noir
- » Colle blanche

- » 100 utilizações
- » Branca
- » Cola preta



Du papier noir recyclé pour cou, qui ne blanchit pas, ne contient pas de chlore, pourrait être utilisé pour le produit alimentaire puisqu'il possède le certificat ISEGA et un certificat FSC de matériaux provenant de forêts contrôlées, gestion forestière durable PEFC

Pack de 5 rouleaux de papier cou spécial pour salon de coiffure, couleur noire

Pack 5 rolos papel de pescoço especial barbearia, cor preta.

O papel reciclado de pescoço cor preto, que não usa alvejante, não tem cloro, pois possui o certificado ISEGA e possui um certificado FSC de material de florestas controladas, manejo florestal sustentável do PEFC

Rouleau de papier cou

Rolo papel pescoço



REF. 00681

- » Élastique
- » Coupe parfaite et confortable
- » Hygiénique
- » Jeter
- » 100 services
- » 500 utilisations
- » Évitez les démangeaisons et les picotements dans le cou

- » Elástico
- » Ajuste perfeito e confortável
- » Higiênico
- » Rejeitar
- » 100 serviços
- » 500 usos
- » Evite coceira e picadas no pescoço/itching in the neck



Séparateurs cheveux

Separadores cabelo



- » Sachet 2 séparateurs
- » Velcro

REF.06440

- » Sachet 2 séparateurs
- » Velcro

REF.06613

- » Pacote de 2 separadores
- » Velcro

- » Pacote de 2 separadores
- » Velcro



Supports pour papier cou

Porta rolos para papel pescoço



- » Pour ref. 00681, 04651, 06296
- » Para ref. 00681, 04651, 06296

REF. 00800

Supports pour papier cou

Porta rolos para papel pescoço



- » Matière : abs noir
- » Peut être accroché au mur.
- » Material: ABS preto
- » Pode-se pendurar na parede e espelho

REF. 06803

NEW



Protecteurs yeux Barber Line

Protetores para os olhos



- Sachet de 50 protecteurs
- Pacote de 50 protetores

REF. 06315

Protecteur d'oreille boîte 50 unites

Ear hood



- » Dimensions: 2 * 4,5 cm
- » Poids: 0,40 grammes
- » Matière plastique

REF. 07008

- » Dimensiones: 2*4.5CM
- » Peso: 0,40 gramos
- » Material Plástico

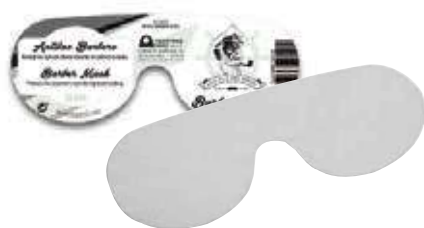

Peignoir de coiffure silicone
Penteador de silicone

EURO*stil*
 PROFESIONALES



1
u.m.vta

10
box

REF. 07006

40x40 cm



Cape de coupe BARBER LINE
Capa corte BARBER LINE



1
u.m.vta

40
box

REF.06988

- » Polyester pongé
- » Hydrofuge
- » Poids 150 g
- » Bouton de fermeture

- » Poliéster pongee
- » Repelente de água
- » Peso 150 g
- » Botão Fechar

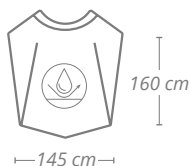

Cape de coupe EUROSTIL
Capa corte EUROSTIL



1
u.m.vta

40
box

REF.06989

- » Polyester pongé
- » Hydrofuge
- » Poids 150 g
- » Bouton de fermeture

- » Poliéster pongee
- » Repelente de água
- » Peso 150 g
- » Botão Fechar

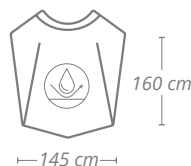

EURO*stil*
 PROFESIONALES

Cape rayée Polo Barber

Capa listrada de Polo Barber



- » Polyester pongé
- » Hydrofuge
- » Poids: 150 grammes
- » Fermeture: crochets

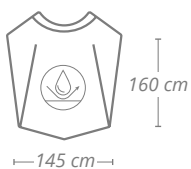

REF.06991

- » Poliéster pongee
- » Repelente de água
- » Peso: 150 gramas
- » Encerramento: Ganchos



Cape rayée blanc-noir

Capa listrada branco-preta



- » Polyester pongé
- » Hydrofuge
- » Poids: 150 grammes
- » Bouton de fermeture

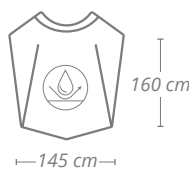

REF.06992

- » Poliéster pongee
- » Repelente de água
- » Peso: 150 gramas
- » Botão Fechar



Cape à rayures tête de mort

Capa de tarja de caveira



- » Polyester pongé
- » Hydrofuge
- » Poids: 150 grammes
- » Fermeture: crochets

REF.06993

- » Poliéster pongee
- » Repelente de água
- » Peso: 150 gramas
- » Encerramento: Ganchos



Cape d'ustensiles

Camada de utensílios



- » Polyester pongé
- » Hydrofuge
- » Poids: 150 grammes
- » Bouton de fermeture

REF.06995

- » Poliéster pongee
- » Repelente de água
- » Peso: 150 gramas
- » Botão Fechar



Cape de coupe BARBER SHOP

Capa corte BARBER SHOP

- » Polyester pongé
- » Hydrofuge
- » Poids: 150 grammes
- » Bouton de fermeture

- » Poliéster pongee
- » Repelente de água
- » Peso: 150 gramas
- » Fecho de botão

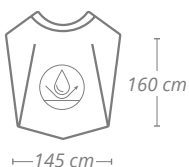

REF.06997

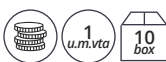

Cape de coupe EUROSTIL

Capa corte EUROSTIL

- » Modèle: tête de mort
- » 100% Nylon
- » Bouton de fermeture

- » Modelo skull
- » 100% Nylon
- » Fecho de botão



REF.04577



Sac 30 capes noires

Bolsa 30 capas pretas

- » Usage unique.
- » Uma só utilização



REF. 07243



NEW

Cape de coupe

Capa corte

- » Grande
- » Velcro

- » Grande
- » Velcro



REF. 01174



Tablier en jean avec poches Avental de ganga com bolsos

- » Poids: 200 grammes
- » Peso: 200 gramos

REF. 07010

- » Poids: 200 grammes
- » Noir avec et détails en cuir synthétique.

REF. 07057

- » Peso: 200 gramos
- » Preto com detalhes em imitação de pele.

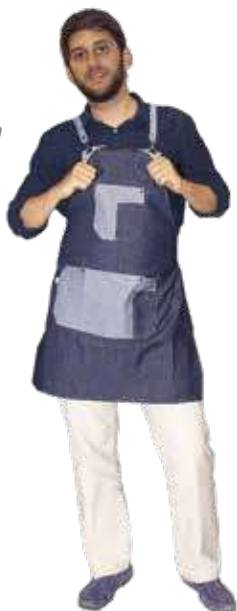
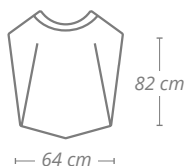

NEW

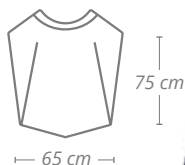

NEW



Tablier bleu BARBER LINE Avental BARBER LINE apron

- » Poids: 200 grammes
- » Marqué du logo Barber Line

- » Peso: 200 gramos
- » Marcada con el logo Barber Line



REF. 07058

Tablier barber line Avental line apron

- » 3 poches 1 en haut, 2 en bas
- » 6 compléments, 1 supérieur et 5 inférieurs

- » 3 bolsos, 1 superior, 2 inferior
- » 6 complementos, 1 superior e 5 inferior



REF. 06182

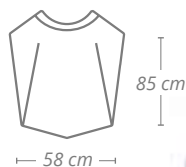
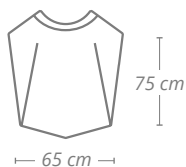

Cape de coupe CAPTAIN COOK

Capa corte CAPTAIN COOK

1 u.m.vta
12 box

- » 100% Nylon
- » 100% Nylon

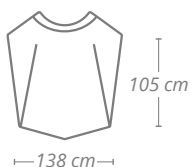

REF.04975/50

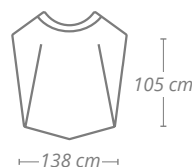

REF.04975/58



Tablier CAPTAIN COOK

Avental COOK APRON

1 u.m.vta
12 box

- » 3 poches 1 en haut, 2 en bas
- » 6 compléments, 1 supérieur et 5 inférieurs
- » 3 bolsos, 1 superior, 2 inferior
- » 6 complementos, 1 superior e 5 inferior

REF. 06181

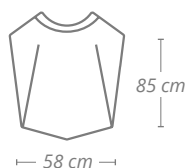

Cape à rayures pour barbier

Capa listrada para barbeiro

1 u.m.vta 40 box

MOD. 21800976

Cape à rayures 100% polyester fine. Avec fermeture crochets. Facile à repasser. Ne déteint pas. Antistatique.

Capa listrada, 100% poliéster fino. Com grampos de suportes de pressão. Antiestático.

 131/132 cm
143/144 cm

REF. 06351

 Largeur
Largura

 Longueur
Longo

Cape barber pole

Capa de pólo de barbeiro

1 u.m.vta 40 box

MOD. 21800974

Cape à rayures 100% polyester. Fermeture crochets. Facile à repasser. Ne déteint pas. Antistatique.

Capa listrada, 100% poliéster fino. Com grampos de suportes de pressão. Antiestático.

 131/132 cm
143/144 cm

REF.06353

 Largeur
Largura

 Longueur
Longo

Cape de camouflage grise

Capa de camuflagem cinza

1 u.m.vta 40 box

MOD. 21800975

- » 100% polyester fin
- » Fermeture crochets.
- » Facile à repasser.
- » Ne déteint pas. Antistatique.

- » 100% fino polyester
- » Com grampos de suportes de pressão.

 131/132 cm
143/144 cm

REF.06352

 Largeur
Largura

 Longueur
Longo

Casaque col mao
Casaco de gola mao1 u.m.vta
40 box**MOD. 51805305**

Col Mao avec fermeture à éclair YKK.
Poches avec rabas anti-cheveux. Facile
à repasser ne déteint pas. Antistatique.
100% polyester fin

Gola Mao com zíper YKK. 100% fino
polyester

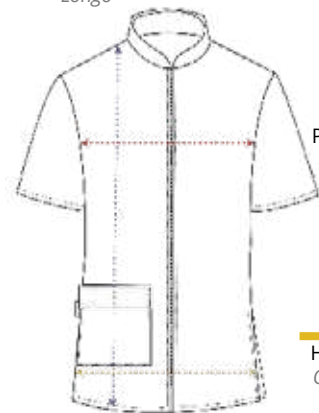
Longueur
LongoPoitrine
PeitoHanche
Quadril

S

106-110 cm
110-114 cm
72-74 cm

REF.06357/50/1

M

112-116 cm
114-118 cm
73-75 cm

REF.06357/50/2

L

118-122 cm
120-124 cm
74-76 cm

REF.06357/50/3

XL

130-134 cm
132-136 cm
75-77 cm

REF.06357/50/4

1 u.m.vta
40 box**MOD. 51805305**Longueur
LongoPoitrine
PeitoHanche
Quadril

S

106-110 cm
110-114 cm
72-74 cm

REF.06357/58/1

M

112-116 cm
114-118 cm
73-75 cm

REF.06357/58/2

L

118-122 cm
120-124 cm
74-76 cm

REF.06357/58/3

XL

130-134 cm
132-136 cm
75-77 cm

REF.06357/58/4

Tablier denim rétro
Avental retro em jeans

1 u.m.vta 40 box

MOD. 31803155

Tablier rétro en jean élastique avec skai marron. Poche centrale. Bretelles ceinture lacet ajustable pour la taille.

- » 60% polyester
- » 37% coton
- » 3% élastique

Denim elástico avental com detalhes de couro falso marron. Bolso central com aplique de utensílio. Grampos reguladores cruzados nas costas. Corte central.

- » 60% polyester
- » 37% algodão
- » 3% elástico



27/28 cm
 69/70 cm
 81/82 cm

REF.06355

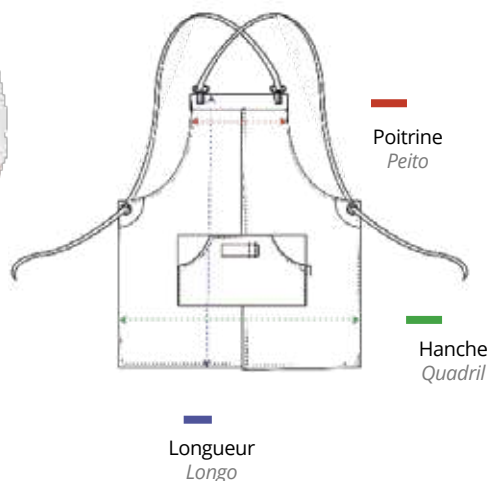

Tablier Denim
Avental jeans

1 u.m.vta 40 box

MOD. 31603125

Tablier denim.Ceinture lacet pour la taille. 4 poches (poche centrale divisée en 2 + 2 petites)

- 60% polyester
- 37% coton
- 3% élastique

Avental de denim elástico bib. Regulamento com cinta e fecho de loop. Com 4 bolsos (bolso central dividido em 2 + 2 pequenos)

- 60% polyester
- 37% algodão
- 3% elástico



25/26 cm
 82/83 cm
 81,50/82,50 cm

REF. 06310/50

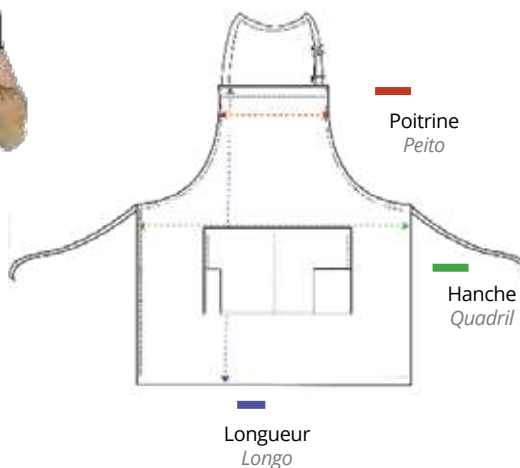

Tablier en polyester
Avental de poliéster1 u.m.vta
40 box**MOD. 31803151**

Tablier cuir. Sans poches.
Imperméable. Courroie
ajustable pour le cou.

» Skai

Avental de couro liso. Sem bolsos
impermeável. Com regulador no
pescoço.

Couro

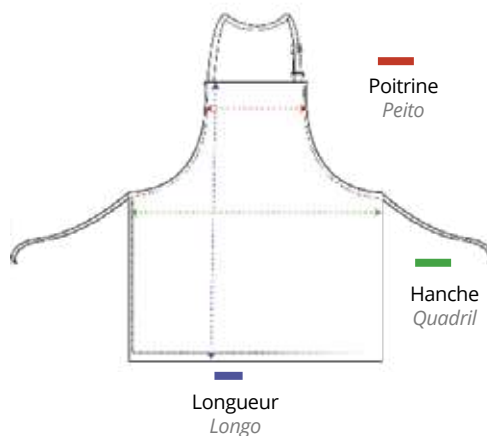

28/29 cm
66/67 cm
81,50/82,50 cm

REF.06350**Pantalon unisex**
Calças unisex1 u.m.vta
40 box**MOD. 41300904**

» Pantalon en polyester avec 3 poches.
» Facile à repasser ne déteint pas.
» 100 % polyester fin.

» Calças finas de poliéster com 3 bolsos.
Cintura ajustável com cordão.
» Antiestático.
» 100 % fino polyester

Longueur
Longo

Taille
Cintura

Hanche
Quadril



S

96-96 cm
92-96 cm
99-101 cm

REF.06356/1

M

102-106 cm
104-108 cm
107-109 cm

REF.06356/2

L

110-114 cm
110-114 cm
107-109 cm

REF.06356/3

XL

112-116 cm
114-118 cm
108-110 cm

REF.06356/4

Spray barber 12 couleurs
Sprays de barbeiro 12 cores

- » 6 ambres + 3 transparentes + 3 gris
- » Matière plastique
- » Poids: 76 grammes

500 ml

REF.06998

- » 6 ambar + 3 transparentes + 3 grises
- » Material plástico
- » Peso: 76 gramos

**Spray barber 12 couleurs**
Sprays de barbeiro 12 cores

- » 6 ambres + 3 transparentes + 3 gris
- » Matière plastique
- » Poids: 86 grammes

650 ml

REF.06999

- » 6 ambar + 3 transparentes + 3 grises
- » Material plástico
- » Peso: 86 gramos

**Spray barber 12 couleurs**
Sprays de barbeiro 12 cores

- » 6 ambres + 3 transparentes + 3 gris
- » Matière plastique
- » Poids: 86 grammes

280 ml

REF.07000

- » 6 ambar + 3 transparentes + 3 grises
- » Material plástico
- » Peso: 86 gramos

**Spray barber calavera 12 couleur**
Sprays de barbeiro 12 cores

- » Avec pulvérisateur japonais
- » Matériel: plastique
- » Poids: 101 grammes
- » 6 ambres + 6 noirs

500 ml

REF.07002

- » Con pulverizador japonés
- » Material: Plástico
- » Peso: 101 Gramos
- » 6 ambar + 6 negras



Pulvérisateur EUROSTIL

Pulverizador EUROSTIL



30 ml

REF.07001

- » Bouteille transparente avec pulvérisateur noir
- » Matière: plastique
- » Poids 45 grammes

- » Botella transparente con pulverizador negro
- » Material: Plástico
- » Peso 45 gramos



Pulvérisateur

Pulverizador



- » **Spray continu** : avec une seule pression, il pulvérise l'eau de manière fine et uniforme, avec la même pression du début jusqu'à la dernière goutte
- » **360°** : il peut être utilisé depuis tous les angles, y compris la tête en bas. Pulvérisation fine, type brume, qui distribue l'eau de manière uniforme sur tous les cheveux
- » **Capacité** : 300 ml rechargeable
- » **Volume fixe de pression** : 1,25 cc continu
- » **Évite la fatigue de la main** par rapport à d'autres spray standards
- » **Sans gaz contaminant**

- » **Spray contínuo**: com uma só pressão no gatilho, pulveriza a água de maneira fina e uniforme com a mesma pressão da primeira até à última gota
- » **360°** Pode usar-se a partir de todos os ângulos, incluindo boca abaixo
- » **Pulverização fina tipo neblina** que distribui a água de maneira uniforme sobre o cabelo todo
- » **Capacidade**: 300 ml enchimento
- » **Volume fixo de pressão**: de 1,25 cc contínuo
- » **Evita a fadiga da mão em comparação com os sprays standards.**
- » **Sem gases contaminantes**

300 ml

REF.04731

NEW

300 ml

REF.07247



300 ml

REF.04978



300 ml

REF.06243



Pulvérisateur BARBER LINE
Pulverizador BARBER LINE» D'aluminium
» Alumínio

280 ml

REF.04837

» Talc
» Talco

180 ml

REF.06118

**Pulvérisateur talc classique BARBER LINE**
Pulverizador clássico talco BARBER LINE

180 ml

REF.06179



180 ml

REF.06178



Pulvérisateur d'aluminium
Pulverizador alumínio

» Intérieur laqué
» Interior lacado

280 ml

REF.01384

» Neutre
» Neutro



280 ml

REF.01384/02

23,5 cm



Présentoir de 30 pulvérisateurs d'aluminium
Expositor 30 pulverizadores alumínio



280 ml

REF.01465

280 ml

REF.01465/02



» Eurostil
» Eurostil

» Neutre
» Neutro

Pulvérisateur en plastique
Pulverizador de plástico

» Avec pendentif
» Com suspensão



130 ml

REF.03401

» Diffuseur noir japonais
» Difusor cor preto japonês



300 ml

REF.04377



Sac à dos - Valise pour barbiers Mochila - Mala para barbeiro



REF.06797

- » 4 grands compartiments avec fermeture zippée
- » Il a des compartiments intérieurs plus spéciaux pour les machines et les ustensiles.
- » Matière: simili cuir polyester
- » Clip sur les poignées avec clip

- » 4 compartimentos grandes com fecho de correr
- » Possui compartimentos interiores mais especiais para máquinas e utensílios.
- » Material: poliéster de couro Simile
- » Grampo nas alças com grampo



Valise noire pour coiffeur Mala de barbeiro cor preta



REF.06438



Valise trolley pour coiffeur en SKAI (vide) Mala trolley pele ecológica Cabeleireiro (Vazia)

Toutes les valises sont vendues vides
Todas as malas são vendidas vazias

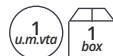

REF.04308

REF.06136



- » 3 grands compartiments avec 2 plateaux au sommet avec des trous pour mettre les ustensiles
- » 4 roues pour le déplacer facilement et facilement
- » Avec roues amovibles

- » 3 grandes compartimentos com 2 bandejas no topo com furos para colocar utensílios
- » 4 rodas para movê-lo com facilidade e facilidade
- » Com rodas removíveis

Valise trolley 4 compartiments**Mala 4 corpos**

REF.04943

Double valise en nylon équipée de roues. Bête peut être utilisée séparément avec bandoulière. Deux compartiments intérieurs qui peuvent être aménagés. Offre beaucoup d'espace de rangement. Intérieur plastifié facile à nettoyer. Grande poche extérieure. Équipée de roues. Son intérieur est également plastifié. Livrée avec un porte-pinceaux cosmétiques fixé au moyen d'un velcro qui peut être déplacé. Elle est équipée de 8 compartiments intérieurs amovibles pour ranger les produits. Une poche extérieure sur chaque côté. La position des deux valises peut être inversée.

Mala de nylon dupla com rodas. A parte superior pode ser convertida em uma bolsa de mão, que vem com uma alça para pendurar no ombro. Tem duas bandejas internas que podem ser movidas para os lados, o interior é largo e a parte inferior é removível e está plastificada para facilitar a limpeza da mala. Também na parte de trás tem um bolso externo.

A parte de baixo com rodas tem a parte interior plastificada e é removível para facilitar a limpeza, vem com um porta-escovas que é preso por um velcro. Este portaescovas pode ser trocado entre a parte superior e inferior. Tem 8 gavetas para armazenar e separar pequenos produtos. Tem um bolso de cada lado. Cada coluna inteira 4 gavetas que estão unidas em uma única peça são removíveis.

**Sac de coiffure avec roues**
Trolley cabeleireiro com rodas

REF.04402/50

- » Avec la structure métallique qui permet d'utiliser la valise comme siège
- » Com estrutura metálica que permite usar a MALA como assento



Trousse à maquillage (vide) incluse dans
Necessaire (vazio) incluido na

**Valise trolley**
Trolley

REF.03814/50

**Valise pour coiffure en aluminium**
Malas alumínio cabeleireiro

REF.04307

- » (Vide)
- » (vazia)



Sachet 75 serviettes CELLULOSE
Pacote 75 toalhas CELULOSE

- » Spéciales manucure
- » Especial manicure

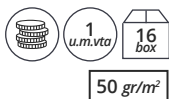
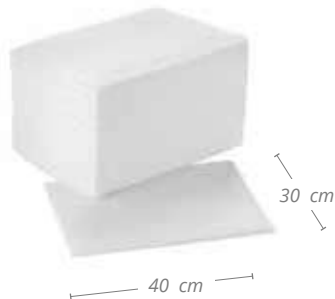

REF. 04204

Sachet de 25 serviettes SPUNLANCE
Pacote 25 toalhas SPUNLANCE

- » Plié à 20 x 20 cm
- » 50% Polyester / 50% viscose

- » Dobrado a 20 x 20 cm
- » 50% poliéster / 50% Viscose

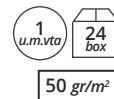

REF. 04916

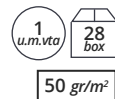

REF. 03221

Sachet 90 Serviettes CELLULOSE
Pacote 90 Toalhas CELULOSE



REF. 04076

Sachet 100 Serviettes SPUNLANCE
Pacote 100 toalhas SPUNLANCE

- » Super absorbantes
- » Superabsorventes.

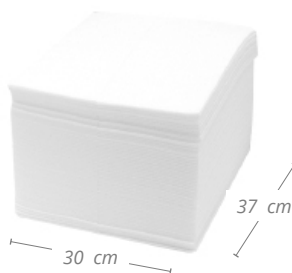

REF. 03283

Sac sachet de 25 serviettes SPUNLANCE
Bag pacote 25 toalhas SPUNLANCE

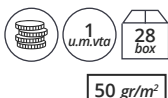

REF. 07233

Sachet de 35 serviettes SPUNLANCE
Pacote 35 toalhas SPUNLANCE

- » Super absorbantes.
- » Serviettes pliées

- » Superabsorventes
- » Toalhas dobradas.



REF. 04509

NEW

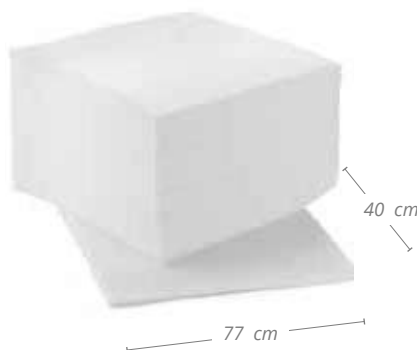
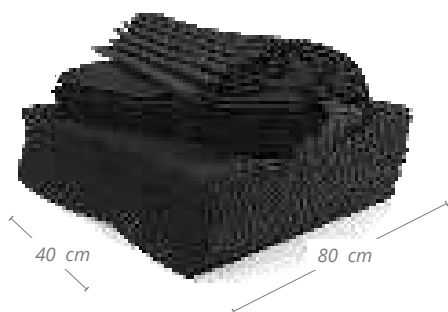

Serviette 100% coton
Toalha 100% algodão



REF. 02947/50

» Résistant à l'eau de Javel
 » Lixívia resistente

REF. 04953/50

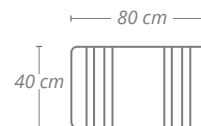
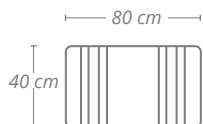

REF. 02901/50

» Résistant à l'eau de Javel
 » Lixívia resistente

REF. 06829/50

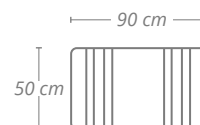
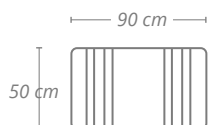

Serviette salon de coiffure 100% coton
Toalha barbearia 100% algodão



380 gr

REF. 06413/50

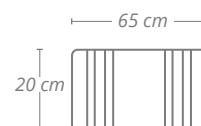

100 Gants pe jetables pour une hygiène irréprochable
100 Luvas pe descartáveis para higiene impecável

REF. 07257

- » Ambidextre permet à chaque gant d'être utilisé pour n'importe quelle main
- » Taille unique
- » Multi usage

- » *Ambidestro permite que cada luva seja usada para qualquer mão*
- » *Tamanho único*
- » *Multiuso*



NEW

**100 Gants en polyéthylène transparent**
100 Luvas transparentes de polietileno

REF. 07804

- » 100% Polyéthylène vierge pehd 0,7 +/- 2% g / pc
- » Hypoallergénique, étanche, taille unique
- » Epi catégorie 1, fabriqué et marqué CE
- » Compatible avec l'usage alimentaire 2011/10 / CE
- » 30 Cm. Hauteur x 25 cm. Largeur des doigts x 15 cm. Largeur du poignet

- » *Polietileno hdpe 100% 0,7 +/- 2% g / pc*
- » *Analérgico, impermeável, um tamanho,*
- » *Categoria 1 epi, produtos e marcações CE*
- » *Compatível com uso de alimentos 2011/10 / CE*
- » *30 Cm de altura x 25 cm de largura x 15 largura do pulso 15*



NEW

**Sachet de 100 gants jetables**
Saco de 100 luvas descartáveis

REF. 07304



NEW



Boîte contenant 20 gants noirs en latex
Caixa 20 luvas látex cor preto
LATEX / LATEX
AQL 1,5PAS de poussière
SEM pó

S/M

M

L

REF. 02832

REF. 02833

REF. 02834



Conforme à la norme / Cumprem a norma: EN 374-1, EN 374-2, EN 374-3, CE

Boîte contenant 100 gants noirs en nitrile
Caixa 100 luvas nitrilo pretas
NITRILE / NITRILLO
AQL 1,5PAS de poussière
SEM pó

S/M

S/M

S/M

REF. 06686

REF. 06687

REF. 06688



Conforme à la norme / Cumprem a norma: EN 374-1, EN 374-2, EN 374-3, CE

Présentoir ciseaux en méthacrylate
Expositor tesouras metalicrato

REF.04074

conteneur pour ciseaux
Recipiente para tesoura

REF.04740

Porte carte de visite
Porta-cartões em alumínio

REF.02470

Ceinture porte-outils
Cinturão porta-utensílios

REF.04310

Toutes les Porte-outils sont
vendues videsTodas as Porta-utensílios são
vendidas vazias

Porte-outils**Estojo ferramentas porta-utensílios**

- » A vec 5 combinables (vide)
 » com 5 combinações (vazio)



REF.03622



REF.03620



REF.03621

**CAPTAIN COOK**
CAPTAIN COOK

- » Porte-outils
 » Estojo ferramentas



REF.04979

- » Casquette noire
 » Chapeu cor preto



REF.07430

**NEW**

- » T-shirt noir
 » T-shirt cor preto



S

REF.04957/4

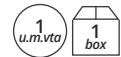

M

REF.04957/1

L

REF.04957/2

XL

REF.04957/3

Solution hydro-alcoolique
Solução hidroalcoólica

NEW 1 u.m.vta 63 box 100 ml REF.07176

NEW 1 u.m.vta 24 box 500 ml REF.07177

NEW 1 u.m.vta 12 box 1 L REF.07260

NEW 1 u.m.vta 12 box 1 L REF.07214

» Avec pompe de dosage
» Con bomba doseadora

Gel hydro-alcoolique À l'Aloe Vera
Gel hidroalcoólico com Aloe Vera

NEW 1 u.m.vta 40 box 100 ml REF.07246

Gel hidro-alcoholico
Gel hidroalcoólico

NEW 1 u.m.vta 12 box 500 ml REF.07216

Alcool 96°
Álcool 96°

NEW 1 u.m.vta 12 box 1 L REF.07218



Articles en vente exclusive en ESPAGNE

Artigos exclusivo de venda EM ESPANHA

Antiseptique daromix gh
Antiséptico daromix gh

500 ml

REF.06200

**Désinfectant au limoseptol**
Desinfetante limoseptol

50 ml

REF. 06151



1 L

REF.06150



- » Numéro d'enregistrement AEMPS: 905-DE5
- » Antiseptique hydroalcoolique pour la désinfection hygiénique des mains par friction.
- » Efficacité scientifiquement garantie
- » Biocide à large spectre de 30 sec.
- » Formule hypoallergénique
- » Préserve l'hydratation de la peau
- » N'irrite pas la peau
- » Sèche rapidement
- » Efficace comme: Bactéricide · Levuricide · Virucide · Microbactéricide

- » Número de registo AEMPS: 905-DE5
- » Anti-séptico hidroalcoólico para desinfecção higiênica de mãos por fricção.
- » Eficácia cientificamente garantida
- » Biocida de amplo espectro a partir de 30 seg.
- » Fórmula hipoaergênica
- » Preserva a hidratação da pele
- » Não irrita a pele
- » Seca rapidamente
- » Eficaz como: Bactericida · Levuricida · Virucida · Microbactericida

- » Numéro d'enregistrement AEMPS: 47-DE5
- » Produit de haut niveau développé exclusivement pour l'hygiène,
- » nettoyage et désinfection, pour les ustensiles professionnels de salon de beauté.
- » Action détergente - Large spectre
- » Biodégradable - Sans phosphates et sans formol
- » Efficacité germicide et SANITIZER contre: Bactéries, levures et champignons.

- » Número de registo AEMPS: 47-DE5
- » Produto de alto nível desenvolvido exclusivamente para higiene,
- » limpeza e desinfecção, para utensílios profissionais de salão de beleza.
- » Ação detergente - amplo espectro
- » Biodegradável - sem fosfatos e sem FORMOLO
- » Eficácia germicida e SANITIZER contra:
- » Bactérias, leveduras e fungos.

Bouteille spécial pour gel et solution hydro-alcoolique
garrafa especial para gel e solução hidroalcoólica



300 ml

REF.07279



NEW

» Avec support mural
 » Com suporte para a parede



300 ml

REF.07278



NEW

Grand bocal em verre pour produit de désinfection
Grande garrafa esterilizador

» Idéal pour stériliser de petits ustensiles
 » Matière: verre

» Ideal para esterilizar pequenos utensílios
 » Material: vidro



1 L

REF.06141



Miroir Espelho

» Miroir noir
» Espelho cor preto



REF. 02591/50



» Miroir TV
» Espelho TV



REF. 00254/50



» Miroir carré avec poignée Noir
» Espelho quadrado com pega Bronco



REF. 01955/50

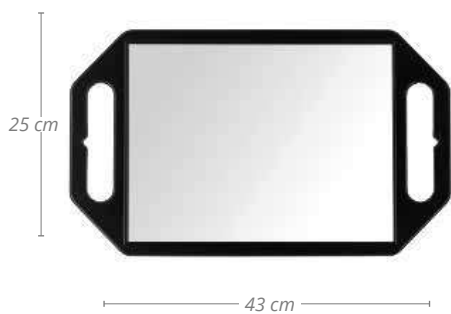

» Miroir double professionnel
» Espelho duplo profissional



REF. 04379

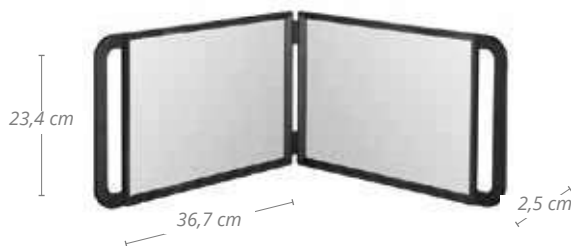

Miroir noir en mousse EVA avec poignée
Espelho espuma EVA com pega cor preto



REF. 02170



Lunettes de protection antibuée

Tapete desinfetante de calçado



REF.07256

- » Protection pour prévenir les infections elles protègent efficacement des éclaboussures, des poussières, etc...
- » Lieu d'utilisation : tous les endroits qui nécessitent une protection des yeux.
- » Design innovant, confortable. Elles s'ajustent parfaitement à toute les formes et tailles de tête.
- » Elles peuvent être utilisées en même temps que des lunettes de vue.
- » Certificat CE
- » Matière : plastique

- » *Proteção para prevenir infeções: protegem eficazmente contra salpicos, cascalho, etc.*
- » *Local de utilização: qualquer lugar onde se requiera proteção para os olhos.*
- » *Design inovador cómodo. Ajustam-se perfeitamente a qualquer forma e tamanho de cabeça.*
- » *Podem-se utilizar por cima dos seus óculos graduados.*
- » *Certificado CE*
- » *Material: plástico*



Tapis désinfection pour semelles de chaussures

Tapete desinfetante de calçado



REF.07234

Tapis extra-plat de seulement 1 cm de hauteur pour éviter les chutes, fabriqué en polypropylène sur une base en caoutchouc et un conteneur en aluminium ionisé. Dimensions : 60 cm de largeur x 40 cm de longueur x 1 cm d'épaisseur/hauteur.

Mode d'emploi : placer le tapis sur une surface plane et nivelée, appliquer dans le plateau environ 700 ml de liquide désinfectant. Il est recommandé de placer un paillason après le plateau pour que le client puisse ensuite s'essuyer les pieds.

Tapete extraplano com apenas 1 cm de altura para evitar que alguém tropece em polipropileno sobre uma base de borracha e contentor de alumínio oxidado. Medidas: 60 cm largura x 40 cm profundidade x 1 cm altura/espessura

Como utilizar: colocar o tapete sobre uma superfície plana e nivelada aplicar na bandeja cerca de 700 ml de líquido desinfetante. Aconselhamos colocar um tapete fofinho à frente deste tapete para secar o calçado do cliente.

NEW



Sac 100 couvre-chaussures

Embalagem 100 cobre-sapatos



REF.07211

- » À usage unique
- » Plastique

- » *Uma só utilização*
- » *Plástico*



NEW



Distributeur gel automatique mural avec plateau
Dispensador gel automático de pared com bandeja

NEW



Distributeur gel automatique de table
Dispensador gel automático de mesa

NEW



Distributeur automatique de gel mural avec support
Dispensador gel automático com pé

NEW



Distributeur mural manuel
Dispensador de parede manual

NEW



- » Matière : ABS
- » Type de pompe : goutte-à-goutte de gel
- » Source d'alimentation : 4 piles (LR14 taille C)
- » Distance de détection : 6-10 cm.
- » Sortie : 0,8 - 1 ml réglable

- » Material: ABS
- » Tipo de bomba: gotas de gel
- » Fonte de alimentação: 4 pilhas (LR14 tamanho C)
- » Distância de detecção: 6-10 cm.
- » Saída: 0,8-1 ml ajustável

Balais en caoutchouc Vassouras de borracha

4
u.m.vta

16
box

REF.01223

- » Avec languette
- » Com aba



5
u.m.vta

20
box

REF. 01285/50



- » Facile à nettoyer et durable, l'efficacité de la conception de ses pointes parvient à faire glisser la poussière sans la soulever, ce qui la rend idéale pour les personnes allergiques car elles favorisent un environnement propre.

5
u.m.vta

20
box

REF.02420

- » Fácil de limpar e duradoura, a eficácia do design de seus espigões consegue arrastar o pó sem levá-lo, tornando-o ideal para quem sofre de alergias, pois favorece um ambiente limpo.



Manche à balai Punho vassoura

- » Nettoyage facile et longue durabilité
- » Support plastique
- » Idéal pour tous les types de sols, en particulier le parquet

12
u.m.vta

12
box

REF.01131

- » Extra télescopique
- » Telescópico extra

10
u.m.vta

10
box

REF.01365

- » Limpeza fácil e longa durabilidade
- » Suporte de plástico
- » Ideal para todos os tipos de pisos, especialmente parquet



- » 140 cm extensible
- » 140 cm extensível



09

Formation

FORMAÇÃO

*Têtes malléable homme,
supports, tépieds...*

*Cabeça manequim
homem, suportes, tripé*



BERGMANN

HAIR AND MORE...

- » Implantation naturelle
- » Pour couper, décolorer, colorer, coiffures, séchage et lissage des cheveux

- » *Implantação natural*
- » *ara corte, descoloração, coloração, penteado, seco e com prancha*



20 cm
aprox.

Boy
REF. 06341

EURO *stil*

PROFESIONAL

Têtes malléables homme 100% CHEVEUX NATURELS Cabeças manequins homem CABELO 100% NATURAL

Support non inclus
Suporte não incluído



- » 42 implantations cm2
- » 7-8 implants capillaires
- » 320 cheveux env. au cm2
- » Pour couper, décolorer, colorer, coiffures, séchage et lissage des cheveux
- » Température maximum 180°C

- » 42 Implantes por cm2
- » 7-8 cabelos por implante
- » 320 cabelo por cm2
- » Para corte, descoloração, coloração, penteado, seco e com prancha
- » Temperatura máxima 180°C

Châtain · Cor castanho

- » Implantation naturelle 45°
- » *Implantação natural 45°*

REF. 02495



15 - 18 cm

Ø 58 cm

Châtain avec barbe · Cor castanho com barba

- » Implantation naturelle 45°
- » Idéale pour exercice de coupe et de taille de barbe

REF. 02169

- » *Implantação natural 45°*
- » *Também para corte de barba*



15 - 18 cm

Ø 58 cm

Têtes malléables homme 100% CHEVEUX NATURELS
Cabeças manequins homem CABELO 100% NATURAL

Support inclus
Suporte incluído



- » 42 implantations cm²
- » 7-8 implants capillaires
- » 320 cheveux env. au cm²
- » Pour couper, décolorer, colorer,
- » coiffures, séchage et lissage des cheveux
- » Température maximum 180°C

- » 42 Implantas por cm²
- » 7-8 cabelos por implante
- » 320 cabelo por cm²
- » Para corte, descoloração, coloração, penteado, seco e com prancha
- » Temperatura máxima 180°C

Châtain clair · Castanho claro

- » Implantation naturelle 45°
- » Implantação natural 45°

Joe
REF. 06147

- » Implantation classique 90°
- » Implantação clássica 90°

Joe
REF. 04909



15 - 18 cm

Ø 54 cm



15 - 18 cm

Ø 54 cm



Châtain clair avec barbe · Castanho claro com barba

- » Implantation naturelle 45°
- » Implantação natural 45°

Daniel
REF. 06148

- » Implantation classique 90°
- » Implantação clássica 90°

Daniel
REF. 04908



15 - 18 cm

Ø 54 cm



15 - 18 cm

Ø 54 cm



Supports tête malléable Suportes cabeça manequim

» Plastique
» Plástico



REF. 00983

» Plastique
» Plástico



REF. 01461

» Plastique
» Plástico



REF. 06276

» Plastique
» Plástico



REF. 06162

» Aluminium
» Alumínio



REF. 03625

Support trépied de tête malléable Suporte tripé cabeça manequim

» Aluminium
» Alumínio

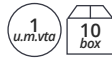

REF. 03738

» Aluminium
» Alumínio



REF. 03624

» Aluminium
» Alumínio



REF. 01841



166 - 81 cm

133 - 65 cm

126 - 78 cm





Spécial esthétique

ESPECIAL ESTÉTICA

ANDREA
Pestañas

BEAUTENE

maniquick
Cuidado profesional de manos y pies

MEDISANA

promed



01 Ligne de soins facial Linha de cuidados faciais 528

Nettoyage et préparation de la peau 529	
<i>Limpeza e preparação do piel</i>	
Crèmes et traitements, huiles essentielles 531	
<i>Creme e tratamentos, óleos essenciais</i>	
Présentoirs et accessoires · <i>Expositores e acessórios</i> 542	
Vapor facial et accessoires · <i>Vapor facial e acessórios</i> 543	

02 Ligne de soins corps Linha de cuidados corpo 546

Crèmes et traitements, huiles de base 547	
<i>Creme e tratamentos, óleos base</i>	
Accessoires · <i>Acessórios</i> 555	

03 Épilation Depilação 556

Cire Kg · <i>Cera Kg</i> 557	
Accessoires cire Kg · <i>Acessórios cera Kg</i> 562	
Roll-on cire · <i>Roll-on cera</i> 568	
Accessoires Roll-on cire · <i>Acessórios Roll-on cera</i> 571	
Pinces à épiler · <i>Pinças de depilar</i> 580	

04 Manucure y pédicure Manicure e pedicure 586

Vernis à ongles Pollié · <i>Esmalte de unhas Pollié</i> 587	
Vernis à ongles semi-permanent P-Lack 593	
<i>Esmalte de unhas semipermanente P-LACK</i>	
Acrylique gel · <i>Gel acrílico</i> 596	
Dissolvant et crème mains 598	
<i>Removedor e creme para as mãos</i>	
Pinceaux à ongles acryliques · <i>Pinças unhas acrílicas</i> 601	
Accessoires NAIL ART · <i>Acessorios NAIL ART</i> 603	
Lampe UV led · <i>Catalizador de unhas Uv Led</i> 612	
Paraffine · <i>Parafina</i> 618	
Ponceuse à ongles · <i>Brocas</i> 620	
Lampe · <i>Lupa</i> 629	
Limes et blocs polissage · <i>Limas e blocos</i> 631	
Stérilisateurs · <i>Esterilizador</i> 648	
Pinces coupe-cuticules · <i>Alicates corta cutículas</i> 650	
Pinces coupe ongles · <i>Corta unhas</i> 655	
Poussoir pour cuticules · <i>Empurrador de cutículas</i> 659	
Accessoires manucure · <i>Acessorios manicure</i> 660	
Ciseaux à peaux et ongles · <i>Tesouras peles e unhas</i> 661	
Bâtons de buis qui servent à pousser les cuticules 663	
<i>Removedor de peles</i>	
Pécifique pédicure · <i>Specific pedicure</i> 664	

05 Maquillage Maquiagem 674

Crayons/mascara pour recourber les cils 675	
<i>Lápis/mascara de pestanhas</i>	
Éponges démaquiller · <i>Desmaquiagem esponja</i> 680	
Éponges pour maquiller · <i>Esponjas maquiagem</i> 682	
Pinceau de maquillage/brosse 685	
<i>Pincel de maquiagem/escobas de maquiagem</i>	

06 Faux-cils Pestanas 700

Faux-cils Pollié · <i>Pestanas Pollié</i> 701	
Faux-cils Andrea · <i>Pestanas Andrea</i> 706	
Kit Faux-cils 710	
<i>Kit pestanas</i>	
Présentoir, dissolvant d'adhésif faux-cils, accessoires 712	
<i>Expositor, dissolvente adesivo pestanas, acessórios</i>	
Sourcils · <i>Sobrancelhas</i> 713	

07 Accessoires et hygiène Acessórios e higiene 714

Dans papier pour table esthétique 715	
<i>Papel para marquesa</i>	
Draps et couvertures, serviettes 716	
<i>Manta, lençois, toalhas</i>	
Protecteurs et gants · <i>Protetores e lluvas</i> 719	
Jetables · <i>Utilização única</i> 722	
Coton · <i>Algodão</i> 728	
Miroirs · <i>Espelhos</i> 729	
Masques faciaux · <i>Máscaras faciais</i> 735	
Vêtement LACLA · <i>Vestuário LACLA</i> 737	
Anneau lumineux à led · <i>Led anelar</i> 743	
Valises · <i>Molas</i> 744	
Pulvérisateur · <i>Pulverizador</i> 750	
Protecteurs UV · <i>Protetores UV</i> 751	
Articles d'hygiène et désinfectante 752	
<i>Artigos higiene e desinfectante</i>	

08 Mobilier Mobiliário 756

Tables de massage · <i>Marquesa</i> 757	
Table de manucure · <i>Mesa manicure</i> 762	
Chariot manucure/pédicure 764	
<i>Carrinho manicure/pedicure</i>	
Tabouret, support, chaise 765	
<i>Banco, suporte, cadeira</i>	
Valises, chaise maquillage 771	
<i>Mala/Tocador, assento maquiagem</i>	

Les prix indiqués dans ce catalogue sont des prix recommandés, taxes en sus.
Les prix seront valables sauf erreurs typographiques.
Industrias Oriol 1942, S.L. se réserve le droit d'apporter des modifications sans préavis.

*Os preços listados neste catálogo são preços recomendados, impostos não incluídos.
Os preços serão válidos, exceto por erros tipográficos.
Industrias Oriol 1942, S.L. reserva-se o direito de fazer modificações sem aviso prévio.*

01

Ligne de soins facial

LINHA DE CUIDADOS FACIAIS

*Nettoyage et préparation de la peau,
crèmes et traitements,
présentoirs, accessoires...*

*Limpeza e preparação da pele,
cremes e tratamentos, expositores,
acessórios ...*



Eau micellaire vs lait démaquillant
Água micelar vs leite de limpeza

Pour un bon nettoyage du visage, un lait nettoyant qui élimine toute la saleté et un tonique qui nettoie les cellules mortes tout en vous aidant à vous débarrasser de vos pores dilatés et les points noirs. Le tonique et Lait démaquillant Tassel contiennent de l'huile à l'azulène qui régule et traite vos problèmes de peau sensible. Vous pouvez également utiliser l'eau micellaire pour gagner du temps dans le processus de nettoyage, c'est un produit doux pour la peau. Plusieurs options pour nettoyer votre peau. Choisissez votre produit!

Para uma boa limpeza facial é fundamental um leite de limpeza que lave todas as impurezas um tónico que limpe os restos, e ao mesmo tempo desinfete e feche os poros. O tónico e o leite de limpeza Tassel contém azuleno que é o mais indicado para peles sensíveis. Também pode utilizar a água Micelar que poupa passos no processo de limpeza e é delicado com a pele. Tem várias opções para limpar a pele. Escolha o seu produto!

Lait démaquillant
Leite de limpeza

500 ml

REF.07094

**Huile d'argan et Aloe Vera**

L'utilisation de lait démaquillant permet d'éliminer les impuretés et les traces de saleté accumulées sur la peau. De cette façon, la peau est oxygénée et semble plus lumineuse et saine. Avec la formule à l'huile d'azulène élimine les résidus de cire. Non grasse, elle apaise et hydrate votre peau sensible, pour la laisser douce et veloutée. D'usage quotidien.

Azeite de Argão e Aloé Vera.

A utilização do leite de limpeza ajuda a eliminar as impurezas e restos de sujidade acumulados na pele. Desta forma, a pele é oxigenada tornando-a mais luminosa e saudável. Com azuleno para peles sensíveis, não oleosa. De uso diário.

Tonique revitalisant
Tónico revitalizante

500 ml

REF.07095

**Huile d'argan et Aloe Vera**

L'utilisation du tonique facial agit comme un équilibrant après le nettoyage avec le lait démaquillant, c'est l'étape définitive pour le compléter. Apporte fraîcheur et vitalité à la peau avec l'huile à l'azulène qui est idéale pour les peaux sensibles. Usage quotidien.

Azeite de Argão e Aloé Vera.

O uso do tónico facial permite o equilíbrio da pele após a utilização do leite de limpeza, é o último passo para completar a limpeza. Proporciona frescura e vitalidade à pele. Com azuleno, ideal para peles sensíveis. Uso diário.

Visage exfoliant
Exfoliante facial**Natural Mineral comme exfoliant**

L'huile d'argan et l'Aloe Vera ont des propriétés restructurantes et régénérantes. L'actif minéral naturel a de grandes propriétés d'exfoliation. Enlever et traîner les cellules mortes sans endommager la peau en la laissant propre, douce, lumineuse et avec une grande capacité respiratoire favorisant l'absorption de tout traitement de beauté. Il peut être utilisé comme un gommage facial régulier.

Mineral Natural como um esfoliante

O óleo de argão e Aloe Vera, tem propriedades de reestruturação e regeneração. O ativo Mineral Natural possui ótimas propriedades de esfoliação. Retire e arraste as células mortas sem danificar a pele deixando-a limpa, suave, luminosa e com grande capacidade respiratória favorecendo a absorção de qualquer tratamento de beleza. Pode ser usado como um esfoliante facial regular.



100 ml

REF.06071

Eau micellaire
Água micelar

400 ml

REF.04206

Black mask nettoyage en profondeur
Black mask limpeza profunda

50 ml

REF.04580

**Nettoie, tonifie et hydrate**

Eau micellaire 3 en 1. Nettoie, démaquille et élimine les impuretés de la peau sans rinçage. Tout en respectant l'équilibre hydrique et le pH de la peau, la laissant propre et douce. Efficace avec le maquillage le plus résistant. Arôme doux de roses.

Limpa, tonifica e hidrata

Água micelar 3 em 1. Limpa, desmaquilha e elimina impurezas da pele sem necessidade de lavar. Respeitando o equilíbrio hídrico e Ph da pele deixando-a limpa e suave. Eficaz com a maquiagem mais resistente. Suave aroma a rosas.

Black Masque "peel off":

Produit fabriqué spécialement sur la base d'une formule douce et efficace, contenant du charbon actif, de l'aloès vera, de l'avoine et de la glycérine végétale. Il permet de nettoyer en profondeur les impuretés de la peau, sans aucun type de dommage ou d'agression.

Máscara peel-off:

Produto elaborado especialmente com uma fórmula suave e eficaz, contem Carvão Ativo, Aloe Vera, Aveia e Glicerina Vegetal. Permite limpar profundamente as impurezas da pele, sem qualquer tipo de dano ou agressão.

TASSEL SKIN COSMETICS, lance la gamme HYALURONIC sur le marché
TASSEL SKIN COSMETICS, lança a linha HYALURONIC no mercado

L'acide hyaluronique est un composant structurel de la matrice extracellulaire de la peau qui, avec le collagène et les fibres élastiques, forme la structure du derme cutané et est responsable de l'hydratation de la peau. Un manque d'hydratation peut produire des effets contre-productifs sur notre derme et notre épiderme, rendant la peau plus sensible aux facteurs qui accélèrent le vieillissement.

O ácido hialurônico é um componente estrutural da matriz extracelular da pele que, juntamente com o colágeno e as fibras elásticas, formam a estrutura da derme dérmica e é responsável por manter a pele hidratada. A falta de hidratação pode produzir efeitos contraproducentes em nossa derme e epiderme, tornando a pele mais sensível a fatores que aceleram o envelhecimento.

» Réf.07800 à la page 541
» Ref.07800 na página 541

**Crème hyaluronique**
Creme hialurônico

Spécifique pour les peaux déshydratées. De par sa composition, il redensifie la peau en réduisant immédiatement la profondeur des rides. Combattez les lignes d'expression. Utilisation quotidienne.

Propriétés:

- » Très hydratante et humidifiante
- » Améliore visiblement la barrière lipidique de la peau
- » Stimule la régénération des cellules de la peau
- » Adoucit les rides d'expression, réduisant la profondeur des rides
- » Comble les ridules et les rides de la peau

Application: Appliquer sur la peau propre tant sur la zone du visage, que le cou et le décolleté avec des massages circulaires doux, jusqu'à absorption complète. Elle peut être appliquée jour et nuit selon les besoins de la peau.

Específico para a pele desidratada. Graças à sua composição, redensifica a pele imediatamente, reduzindo a profundidade das rugas. Lute contra as linhas de expressão. Uso diário.

Propiedades:

- » Altamente hidratante
- » Melhora visivelmente a barreira lipídica da pele
- » Estimula a regeneração das células da pele
- » Suaviza as linhas de expressão, reduzindo a profundidade das rugas
- » Preenche as linhas finas e as rugas da pele

Aplicação: Aplicar na pele limpa, área facial, pescoço e decote, com massagens circulares suaves, até completa absorção. Pode ser aplicado dia e noite, dependendo da necessidade da pele.



50 ml

REF.06798

Sérum concentré hyaluronique
Soro concentrado hialurônico

Comblement des rides. Effet anti-âge, neutralise les effets du passage du temps, laissant la peau plus hydratée, élastique et lumineuse.

C'est un sérum à haute concentration d'acide hyaluronique qui aide à réhydrater la peau et à prévenir la perte d'eau, tout en renforçant ses défenses et en améliorant considérablement son volume, sa fermeté et sa douceur.

Application: Appliquer matin et soir avant la crème hydratante, sur la peau du visage, du cou et du décolleté propres et secs. Masser jusqu'à absorption complète.

Efeito antienvelhecimento, neutraliza os efeitos da passagem do tempo, deixando a pele mais hidratada, elástica e luminosa. É um soro com uma alta concentração de ácido hialurônico que ajuda a reidratar a pele e evitar a perda de água, fortalecendo suas defesas e melhorando muito seu volume, firmeza e suavidade.

Aplicação: Aplicar de manhã e à noite, antes do hidratante, área facial, pescoço e decote, limpa e seca. Massagem até completa absorção.



50 ml

REF.06799



Crème hydratante de jour Crema hidratante de dia

Huile d'argan et Aloe Vera

Traitement hydro-nutritif qui stimule et restabilise les mécanismes de la peau. Graças aos seus ativos: eau glacée lipossative, acide hyaluronique, céramides, aloès vera et huile d'argan, restaure la barrière da pele, un lipide naturel, en évitant la perte d'eau transépidermique (TWEL). Melhora a suavidade, equilíbrio de l'eau et flexibilidade da pele.

Azeite de Argão e Aloé Vera

Tratamento hidro-nutritivo que estimula e restabelece os mecanismos da pele. Graças aos seus ativos: Água Glacial Lipossomática, Ácido Hialurônico, Ceramidas, Aloe Vera e Óleo de Argan, restaura a barreira lipídica natural da pele, evitando a perda de água transepidermica (TWEL). Melhora a suavidade, equilíbrio de água e flexibilidade da pele.



50 ml

REF.06451



200 ml

REF.07184



3 ml

REF.06653



Crème nutritive de nuit Crema de noite nutritivo

Huile d'argan et à l'aloé vera

Crème hydratante enrichie à l'huile d'argan et à l'aloé vera. Indiqué pour tous les types de peau. Ses principes actifs stimulent la capacité cellulaire contre les radicaux libres et aident à la régénération du derme. Apporte luminosité, douceur et fermeté à la peau. Absorption rapide Appliquer quotidiennement de préférence la nuit.

Óleo de Argan e Aloe Vera

Crema hidratante enriquecido com Óleo de Argan e Aloe Vera. Indicado para todos os tipos de pele. Seus princípios ativos estimulam a capacidade celular contra os radicais livres e ajudam na regeneração da derme. Traz luminosidade, maciez e firmeza à pele. Absorção rápida Aplicar diariamente de preferência à noite.



50 ml

REF.03541



200 ml

REF.03699



3 ml

REF.07297

NEW



Extrait de caviar et de rose musquée
Extrato de Caviar e Rosa Mosqueta**Crème nutritive caviar**
Creme de noite caviar

Indiqué pour les peaux matures. Crème à haute puissance pour vous régénérer. Préviens et adoucit les signes du vieillissement et ceux causés par les agressions extérieures. À utiliser de préférence deux fois par jour.

Indicado para peles maduras. Creme altamente regenerador. Previne e suaviza os sinais de envelhecimento causados pelas agressões externas. Recomendamos utilizar duas vezes por dia.



50 ml

REF.03543



200 ml

REF.06452



3 ml

REF.06654

**Crème E-Pigment dépigmentant**
Creme E-Pigment despigmentação

Essentiellement conçue pour agir sur les zones plus foncées du visage, elle aide à freiner la production de mélanine et stimule la génération de nouvelles cellules qui renouvellent la peau, afin de retrouver son teint naturel. Enrichie en extraits de Réglisse, acide kojique et alpha-hydroxyacides.

- » Elle éclaircit et réduit l'intensité des taches.
- » Elle augmente la luminosité et homogénéise la couleur de la peau.
- » Elle améliore l'hydratation et la fonction barrière de la peau
- » Elle protège la peau des effets néfastes du soleil et prévient l'apparition des taches.

Essencialmente formulada para atuar sobre as zonas mais escuras do rosto, ajudando a travar a produção de melanina e estimulando a geração de novas células que renovam a pele, recuperando assim o seu tom habitual. Enriquecido com Glycyrrhiza glabra root extract, Kojic acid, alfa hidroxiácidos.

- » Aclara e reduz a intensidade das manchas
- » Aumenta a luminosidade e homogeniza o tom da pele
- » Melhora a hidratação e a função barreira da pele
- » Protege a pele do dano solar e previne o aparecimento de manchas



50 ml

REF.06800





Crème hydratant d'or Crema hidratante de ouro

Or et Rose musquée

Indiqué pour les peaux matures, usage quotidien. Les oligo-éléments naturels stimulent la capacité cellulaire contre les radicaux libres, favorisent la régénération du derme, agissent contre la flaccidité et apportent luminosité, fermeté et fermeté à la peau. Émulsifiant à la pointe de la technologie: Émulsifiant non ionique, naturel et sans PEG. Cliniquement prouvé, il possède d'importantes propriétés hydratantes et améliore visiblement la texture de la peau.

Or: Renforce la luminosité (idéal pour les peaux ternes et très foncées) a également un effet tenseur et régénérant: une peau visiblement plus jeune

Argirelox: Ce peptide est un ingrédient actif qui combat les rides d'expression en atténuant la contraction musculaire dans la voie pré-synaptique

Pollushield: ingrédient fonctionnel qui agit comme une barrière entre la peau et les contaminants dans l'environnement et augmente également le potentiel antioxydant de la peau

Rose musquée: Anti-rides naturelles qui favorisent la production de collagène, d'élastine et d'acide hyaluronique, qui donnent de la fermeté et de l'élasticité à la peau

Ouro e rosa mosqueta

Indicado para pele madura, uso diário. Os oligoelementos naturais estimulam a capacidade celular na regeneração da derme, agem contra a flacidez e trazem luminosidade e firmeza à pele.

Emulsionante de última geração: Emulsionante não iônico, natural sem de PEG. Clinicamente comprovado, possui propriedades hidratantes significativas e melhora visivelmente a textura da pele.

Ouro: Reforça a luminosidade (ideal para pele opaca e muito escura) também tem um efeito tensor e regenerador: pele visivelmente mais jovem.

Argirelox: Este peptídeo é um ingrediente ativo que combate rugas de expressão atenuando a contração muscular na via pré-sináptica.

Pollushield: Ingrediente funcional que atua como uma barreira entre a pele e contaminantes no ambiente e também aumenta o potencial antioxidante da pele.

Rosa Mosqueta: Natural anti-rugas que promove a produção de colágeno, elastina e ácido hialurônico, que dão firmeza e elasticidade à pele.



50 ml

REF.04980



200 ml

REF.07185



3 ml

REF.06655



Cellules actives · anti âge · cellules souches végétales
Celulas activas – anti-envelhecimento · células estaminais vegetais

L'extrait de cellules souches d'origine végétale prévient et ralentit le vieillissement prématuré. Il aide à stimuler la régénération du tissu cutané, en fournissant la fermeté, l'élasticité et en atténuant les taches et les rides produites par le passage du temps. Sérum rapidement absorbé par sa texture légère. Appliquez le sérum avant la crème et utilisez les deux produits pour un résultat plus efficace.

Propriétés:

Anti-vieillessement et anti-âge en ralentissant le processus de vieillissement et en stimulant la régénération cellulaire dans le tissu cutané

Réparation des effets nocifs de l'environnement, en particulier la pollution et les rayons UV

O extrato das Células Estaminais de Origem Vegetal previne e retarda o envelhecimento prematuro. Ajuda a estimular a regeneração do tecido cutâneo, proporcionando-lhe firmeza, elasticidade e atenua as manchas e rugas produzidas pela passagem do tempo. Rápida absorção pela sua textura leve. Aplicar o sérum antes do creme, utilizar ambos produtos para um resultado mais eficaz.

Propriedades:

Antienvelhecimento ao retardar o processo de envelhecimento e estimular a regeneração celular no tecido cutâneo

Reparação dos efeitos nocivos do meio ambiente, especialmente da poluição e da radiação UV



» Réf.03926 à la page 542

» Ref.03926 na página 542

Crème
Creme

50 ml

REF.03702



3 ml

REF.06656



30 ml

REF.03703



Indiquée pour les peaux matures. Appliquer la nuit. Adaptée à une utilisation quotidienne.

Indicada para peles maduras. Aplicar à noite, de uso diário.

Sérum
Sérum

Un sérum d'absorption rapide grâce à sa texture légère. Appliquer le matin. Adapté à une utilisation quotidienne

Rápida absorção graças à sua textura leve. Aplicar de manhã. Uso diário

Collagène
Colagénio**Concentré de collagène à effet immédiat**

Grâce à son effet raffermissant et à sa concentration, il corrige progressivement l'affaissement du visage, en particulier les zones: zone des yeux, des lèvres, le cou, etc ... Adapté à une utilisation quotidienne. Ne laisse pas de trace de gras. Absorption rapide. Appliquer quotidiennement.

Efeito imediato

Grças ao seu poder reafirmante e ao seu grau de concentração corrige-se gradualmente a flacidez do rosto, especialmente as zonas: contorno de olhos, lábios, pescoço, etc. Uso diário. Não é oleoso e é de rápida absorção. Aplicar diariamente.



30 ml

REF.03548

» Réf.04664 à la page 542

» Ref.04664 na página 542

Contour des yeux focus 3
Contorno de olhos - focus 3

Crème de texture fraîche et légère qui aide à réparer les petites rides autour des yeux. D'usage quotidien. Grâce à ses ingrédients actifs dont l'action de la Vitamine C: Antioxydante contre radicaux libres. Camomille: Apaisante et décongestionnante. Bêta-carotènes: anti-vieillessement. Fournit la douceur et aide à résorber les poches, les cernes et les signes de fatigue.

Crema de textura fresca e leve que ajuda à reparação das pequenas rugas do contorno dos olhos. De uso diário. Princípios ativos: Vitamina C: antioxidante e anti-radical livre. Camomila: Calmante e descongestionante.

Betacarotenos: Anti envelhecimento. Proporciona elasticidade, ajuda a combater os papos, olheiras e sinais de fadiga.



30 ml

REF.03741



3 ml

REF.06658





Ligne astringente Linha adstringente



Mousse nettoyante T-PURITY Limpeza mousse T-PURITY



200 ml

REF.06084

Ligne de
fourrure
grasses /
astringents
Linha de pele
gorduras /
adstringentes

Excellentes propriétés sébo-régulatrices, hydratantes et revitalisantes de la peau qui éliminent délicatement le maquillage, les impuretés et l'excès d'huile sans irriter la peau. Sa texture liquide se transforme en une mousse légère et douce qui procure un nettoyage en profondeur, hydrate et maintient l'équilibre cutané. Récupère un aspect mat et velouté. Pour ses atouts, il apporte des bienfaits: Pore raffiné et réduit, brillance diffuse, texture de la peau adoucie et épurée, aspect doux et mat.

Excelentes propriedades reguladoras, hidratantes e condicionadoras da pele, que eliminam delicadamente a maquiagem, as impurezas e o excesso de óleo sem irritar a pele. Sua textura líquida é transformada em uma espuma leve que proporciona uma limpeza profunda, hidratando e mantendo o equilíbrio da pele. Recupera uma aparência mate e aveludada. Por seus ativos, proporciona benefícios: Porosidade reduzida, brilho difuso, textura da pele amaciada e purificada, aparência macia e mate

Astringent tonique T-PURITY Tônica astringente T-PURITY



200 ml

REF.06085

Ligne de
fourrure
grasses /
astringents
Linha de pele
gorduras /
adstringentes

Le toner facial astringent, spécialement formulé pour les peaux grasses, régule l'excès de sébum, prévient la brillance et aide à éliminer les imperfections. Grâce à ses atouts, il ferme les pores. Il aide à obtenir un effet mat et doux sur la peau, en contrôlant la brillance et la graisse sur la peau. Combattre et prévenir les imperfections: réguler les propriétés du sébum, aider à contrôler la prolifération bactérienne, prévenir l'infection des pores qui provoque l'apparition de l'acné.

O toner facial adstringente, especialmente formulado para pele oleosa, regula o excesso de óleo, previne o brilho e ajuda a eliminar as imperfeições. Graças aos seus ativos, fecha os poros. Ajuda a obter um efeito mate e macio na pele, controlando o brilho e a gordura da pele. Combate e previne as imperfeições: regulando as propriedades do sebo, ajuda a controlar a proliferação bacteriana, prevenindo a infecção dos poros que causam o aparecimento da acne.

Crème astringente T-PURITY Crème astringente T-PURITY

Texture Crème-Gel fraîche et légère, formulée avec des agents matifiants hydratants et sébo-régulateurs provoqués par l'excès d'huile sur la peau. Minimise les pores, les points noirs et les boutons. Il est formulé avec des actifs végétaux agissant comme anti-inflammatoires, restructurant la barrière lipidique, les agents matifiants et les séborégulateurs.

Crème-Gel de texture fresca e leve, formulado com agentes matificantes hidratantes e reguladores de sebo, causados pelo excesso de oleosidade da pele. Minimiza poros. 8 acne formulado com ativos vegetais que atuam como anti-inflamatórios, reestruturação da barreira lipídica, agentes matificantes e seboreguladores.

Ligne de
fourrure
grasses /
astringents
Linha de pele
gorduras /
adstringentes



50 ml

REF.06086



3 ml

REF.06657



Huiles essentielles · Óleos essenciais

La majorité des huiles essentielles sont obtenues par distillation et pressage à froid, de cette façon nous obtenons un liquide qui représente l'essence pure de la plante et nous permet de profiter de toutes ses propriétés.

A maioria dos óleos essenciais é obtida por destilação e prensagem a frio, obtendo assim um líquido que representa a essência pura da planta e nos permite desfrutar de todas as suas propriedades.



» Réf.04995 à la page 542
» Ref:04995 na página 542



Huile essentielle lavande · Óleo essencial lavanda

C'est un antibiotique naturel et un agent antiseptique et cicatrisant. Drainant, Cellulite, aide à diluer les nodules sous-cutanés, est un grand antiseptique, agit efficacement contre les micro-organismes bactériens et fongiques. Anti-inflammatoire, combat les problèmes de peau tels que l'acné. Il aide également à régénérer le derme après des brûlures, car il active le métabolisme cellulaire. La lavande contribue à la régénération active du tissu pour garder la peau plus jeune. Fournit une hydratation supplémentaire. Vous pouvez également appliquer quelques gouttes de cette huile dans tout traitement du visage ou du corps.

É um antibiótico natural e um agente anti-séptico e curativo. Drenagem, celulite, ajuda a diluir os nódulos subcutâneos, é um ótimo anti-séptico, age eficazmente contra microorganismos bacterianos e fúngicos. Anti-inflamatório, combate problemas de pele como acne. Também ajuda a regenerar a derme após queimaduras, pois ativa o metabolismo celular. Lavanda contribui para a regeneração ativa do tecido para manter a pele mais jovem. Fornece uma hidratação extra. Também pode aplicar algumas gotas deste óleo em qualquer tratamento facial ou corporal.



30 ml

REF.06049

15 ml

REF.06044

Huile essentielle rose musquée · Óleo essencial rosa mosqueta

C'est un excellent régénérateur de peau. Il agit superficiellement comme un facteur hydratant naturel, améliorant l'hydratation. Nourrit et régénère visiblement les cicatrices et les rides atténuantes. Corrige et prévient les problèmes de peau dus au photo-vieillessement, grâce à l'auto-génération de mélanine. Pour éviter les vergetures pendant la grossesse, il est recommandé d'utiliser pendant le dernier trimestre de la grossesse dans l'abdomen et les seins. Il contribue à redistribuer la pigmentation permettant d'atténuer ou d'éliminer les taches dues à des cas d'acné, de taches solaires, etc. Action tonifiante, cicatrisante, rajeunissante et prévient l'oxydation des cellules.

É um ótimo regenerador de pele. Atua superficialmente como um fator natural de hidratação, melhorando a hidratação. Nutre e regenera visivelmente atenuando cicatrizes e rugas. Corrige e previne problemas de pele devido ao fotoenvelhecimento, através da autogeração da melanina. Para evitar estrias durante a gravidez, recomenda-se usar durante o último trimestre da gravidez no abdômen e seios. Contribui para redistribuir a pigmentação permitindo que as manchas sejam atenuadas ou eliminadas, devido a casos de acne, manchas solares, etc. Ação tonificante, cura, rejuvenescimento e impede a oxidação das células.



30 ml

REF.06053

15 ml

REF.06052

Huile essentielle eucalyptus · Óleo essencial eucalipto

Effet amincissant, rétention d'eau, astringent, agit comme antibactérien dans les affections cutanées, pédiculose et pellicules, effet rafraichissant, rétrécit les vaisseaux sanguins périphériques. (Idéal jambes fatiguées pour masser). L'ajout de quelques gouttes de cette huile dans le shampooing quotidien, est une excellente option pour la stimulation des follicules pileux et du cuir chevelu ainsi que pour lutter contre les pellicules. Vous pouvez également appliquer quelques gouttes de cette huile dans tout traitement du visage ou du corps.

Efeito de emagrecimento, retenção de líquidos, adstringente, atua como antibacteriano em condições de pele, pediculose e caspa, efeito refrescante, encolhe vasos sanguíneos periféricos. (Pernas cansadas ideal para massagear). Adicionando algumas gotas deste óleo no xampu diário, é uma ótima opção para a estimulação dos folículos pilosos e do couro cabeludo, bem como para combater a caspa. Você também pode aplicar algumas gotas deste óleo em qualquer tratamento facial ou corporal.



30 ml

REF.06048

15 ml

REF.06043

Huiles essentielles · Óleos essenciais

La majorité des huiles essentielles sont obtenues par distillation et pressage à froid, de cette façon nous obtenons un liquide qui représente l'essence pure de la plante et nous permet de profiter de toutes ses propriétés.

A maioria dos óleos essenciais é obtida por destilação e prensagem a frio, obtendo assim um líquido que representa a essência pura da planta e nos permite desfrutar de todas as suas propriedades.



» Réf.04995 à la page 542
» Ref.04995 na página 542

**Huile essentielle arbre à thé · Óleo essencial árvore do chá**

Ses applications reposent essentiellement sur ses propriétés antibactériennes et antiseptiques, auxquelles il associe un léger effet anesthésique local.

Ses propriétés: Cicatrizante, dermoprotecteur, agit directement sur la dégradation de la sueur, dermopurifiante, eczéma, feridas, manchas do rosto, mãos, decote. Drenagem e emagrecimento. Também é usado para cutículas depois de terem sido removidas por sua ação anti-séptica.

Suas aplicações baseiam-se basicamente em suas propriedades antibacterianas e anti-sépticas, às quais se associa um efeito anestésico local moderado.

Suas propriedades: Cicatrizante, dermoprotetor, atua diretamente na degradação do suor, dermopurificante, eczema, feridas, manchas do rosto, mãos, decote. Drenagem e emagrecimento. Também é usado para cutículas depois de terem sido removidas por sua ação anti-séptica.



30 ml

REF.06046

15 ml

REF.06041

Huile essentielle romarin · Óleo essencial alecrim

Cheveux: Il est recommandé de renforcer les cheveux. Stimule la circulation favorisant la croissance et le renforcement des racines, et améliore la structure capillaire des cheveux fins et cassants.

Peau: Le romarin est largement utilisé dans les crèmes cosmétiques anti-âge, un excellent antioxydant. Certains de ses composants, tels que l'acide rosmarinique, favorisent la formation de nouvelles cellules. Il est décongestionnant, anti-inflammatoire, cicatrisant, rafraîchissant et astringent.

Cabelo: Recomenda-se para fortalecer o cabelo. Estimula a circulação promovendo o crescimento e fortalecendo as raízes e melhorando a estrutura capilar dos cabelos finos e quebradiços.

Pele: O alecrim é amplamente utilizado em cremes cosméticos antienvhecimento, um excelente antioxidante. Alguns de seus componentes, como o ácido rosmarinico, promovem a formação de novas células. É descongestionante, antiinflamatório, curativo, refrescante e adstringente.



30 ml

REF.06047

15 ml

REF.06042

Huile essentielle menthe · Óleo essencial hortelã

Dans la peau, il est très utile car il aide à retenir l'humidité en évitant le vieillissement prématuré. Si utilisé dans des massages, dans des domaines spécifiques, vous pouvez obtenir un effet relaxant unique. Appliquer dans une crème de base quotidienne, agit sur la rougeur de la peau due à l'inflammation ou l'acné. L'utilisation de l'huile essentielle de menthe a des propriétés: Régulation de la graisse de la peau, nettoyage de l'acné, élimination de l'œdème et de la rétention d'eau, réduction de la cellulite, décongestion et action rafraîchissante de la peau.

Na pele é muito útil porque ajuda a reter a umidade evitando o envelhecimento prematuro. Se usado em massagens, em áreas específicas, pode obter um efeito relaxante único. O óleo essencial de hortelã tem propriedades: Regulação da gordura da pele, limpeza da acne, eliminação do edema e retenção de líquidos, redução da celulite, descongestionamento e ação refrescante da pele.



30 ml

REF.06050

15 ml

REF.06045

Masque facial normal et mixte
Máscara facial de pele normal e mista

400 ml

REF.04454

Zone T: Avant, menton

C'est une combinaison de peau sèche et de peau grasse. Certaines zones ont tendance à avoir plus de sébum excessif comme la zone T (front, nez et menton) et d'autres zones souffrent davantage de déshydratation, comme cela se produit habituellement dans la zone U (zone sous les pommettes et la mâchoire).

Ses actifs d'origine végétale, Rheum Rhaponticum Root Extract, agissent en activant les mécanismes naturels d'hydratation de la peau, réalisant: Reconstruction de la couche cornée et de ses composants, régulation de la desquamation, restauration de la fonction barrière

Zona T: Frente, queixo

É uma combinação de pele seca e pele oleosa. Algumas áreas tendem a ter mais excesso de sebo, como a zona T (testa, nariz e queixo) e outras áreas sofrem mais de desidratação, como geralmente acontece na zona U (área sob as maçãs do rosto e mandíbula).

Seus ingredientes ativos de origem vegetal, Extrato de Raiz Rumonticum Rheum, atuam ativando os mecanismos naturais de hidratação da pele, conseguindo: Reconstrução do estrato córneo e seus componentes, regulação da descamação, restauração da função barreira.

**Peaux de masque facial dry**
Máscara facial peles seca

400 ml

REF.04974

Grande hydratation

La peau sèche a toujours besoin d'un apport important d'hydratation et de soins plus spéciaux, car ils ont tendance à rougir facilement et sont plus sensibles. Par conséquent, le masque facial pour peaux sensibles, grâce à ses principes actifs d'origine végétale, l'extrait d'écorce de salix alba (saule), l'alternifolia melaleuca, l'extrait de racine de curculigo orchioïdes, agit sur le mécanisme interne de contrôle du pH cutané, réparant la fonction barrière et provoquant une diminution de la réactivité et de la sensibilité de la peau. Ainsi, il améliore la cohésion entre les cellules, rendant ainsi l'intégrité de l'épiderme.

Ótima hidratação

A pele seca sempre precisa de um suprimento importante de hidratação e de cuidados mais especiais, pois tendem a ficar avermelhados com facilidade e são mais sensíveis. Portanto, a máscara facial para a pele sensível, graças aos seus ingredientes ativos de origem vegetal, extrato de casca de salix alba (salgueiro), alternifolia melaleuca, extrato de raiz de curculigo orchioïdes, atua no mecanismo interno de controle cutâneo do pH, reparando a função barreira e causando uma diminuição na reatividade e sensibilidade da pele. Assim, melhora a coesão entre as células, retornando assim a integridade da epiderme.



Masque visage graisse peau
Pele máscara facial

400 ml

REF.03810

Équilibre l'excès de graisse

Il maintient un équilibre hydrique hydratant et empêche tout agent extérieur tel que la sueur, l'humidité, etc., de produire des bactéries. L'un de ses composants est chargé d'exercer une action absorbante contre l'humidité. Cela permet de laisser sur la peau, un film protecteur qui cède la peau, exerçant sa fonction de catharsis et d'hydratation. Son extrait actif de feuille de barosma bétuline, équilibre les excès de graisse et traite les pores visibles en diminuant leur nombre et leur taille, équilibrant la sécrétion sébacée et améliorant visiblement la texture de la peau.

Equilibra o excesso de gordura

Mantém um equilíbrio hidratante da água e impede que qualquer agente externo, como suor, umidade, etc., produza bactérias. Um de seus componentes é responsável por exercer uma ação absorvente contra a umidade. Isso permite deixar sobre a pele, um filme protetor que cede à pele, exercendo sua função de catarse e hidratação. Seu extrato ativo de folhas de barosma betulina, equilibra o excesso de gordura e trata os poros visíveis, diminuindo-os em número e tamanho, equilibrando a secreção sebácea e melhorando visivelmente a textura da pele.

**Présentoir hyaluronique (en cadeau)**
Expositor hyaluronico (de oferta)

REF.07800

Il inclue 2 Crèmes à l'acide hyaluronique réf. 06798 + 2 sérums à l'acide hyaluronique réf. 06799.

Inclui 2 Cremes de ácido hialurónico ref. 06798 y + 2 sérums de ácido hialurónico ref. 06799.

NEW



Présentoir essences 30 ml Expositor essências 30 ml



REF.04995



- » 42 huiles essentielles
 - » 6 modèles de 15 ml pour chaque référence (x6)
 - » 1 modèle de 30 ml pour chaque référence (x6)
 - » Cadeau 20 brochures
 - » Présentoir en bois
- » Expositor de 42 óleos essenciais
- » 6 modelos de 15 ml para cada referência (x6)
 - » 1 modelo de 30 ml para cada referência (x6)
 - » Brochuras para presente 20
 - » Mostrador de madeira

Présentoir essences en bois 15 ml Expositor essências madeira 15 ml



REF.04995/01



» Vide
» Vazio

2 + 1 Gratuit 2 + 1 Grátis



REF.04664



- Présentoir pour les crèmes composé de:
- » 3 crèmes de jour Hydra-Nutrive (REF. 03540)
 - » 3 crèmes de nuit Hydra-Nutrive (REF. 03541)
 - » 3 Crèmes Hydratantes d'Or (REF. 03542)
 - » 3 crèmes nourrissantes au caviar (REF. 03543)
 - » 6 collagènes purs (REF. 03548)
 - » 20 brochures d'information
 - » 12 x 5 Sachets + Poster

Exibição de cremes contém:

- » 3 Cremes de dia Hydra-Nutrive (REF. 03540)
- » 3 Cremes de noite Hydra- Nutrive (REF. 03541)
- » 3 Cremes hidratantes de Ouro (REF. 03542)
- » 3 Cremes nutritivos de caviar (REF. 03543)
- » 6 Colagénio puro (REF. 03549)
- » 20 Folhetos informativos
- » 12 x 5 Saquetas + Poster

4 + 1 Gratuit 4 + 1 Grátis

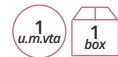

REF.03926



- Présentoir composé de:
- » 5 crèmes actives · cellular anti-âge des cellules souches végétales
 - » 5 sérums actifs · cellular anti-âge des cellules souches végétales

Pack composto por:

- » 5 cremes active · cells Anti-Idade de Células Estaminas Vegetais
- » 5 sérums active · cells Anti-Idade de Células Estaminas Vegetais

Sauna facial
Sauna facial

MEDISANA®

1
u.m.vta4
box

105 W

REF. 03280

- » Indiqué pour nettoyer la peau et soulager les maladies respiratoires
- » Accessoires: tasse à mesurer et accessoire pour le nez
- » Diffuseur pour que le spray soit constant
- » Chauffage PTC de haute qualité
- » Facile à nettoyer
- » Puissance: 105 W

- » Indicado para limpeza da pele e para o alívio de problemas respiratórios
- » Acessórios: copo de medição e acessório para o nariz
- » Difusor para que o spray seja constante
- » Aquecedor PTC de alta qualidade
- » Fácil de limpar
- » Potência: 105 W

**Vapor facial**
Vapor facial1
u.m.vta1
box

1 L

REF. 04952



Utilisez uniquement avec de l'eau distillée. Avec fonction vapeur froide et chaude. La vapeur incorpore la fonction de vapeur OZONE, qui génère plus de vapeur d'eau dans les vapeurs froide et chaude. Lorsque l'eau est en dessous du minimum, la vapeur s'éteindra automatiquement pour des raisons de sécurité. La tête peut pivoter à 120°.

- » Tension: 220-240V
- » Fréquence: 50-60Hz
- » Puissance: 650 W
- » Capacité de dépôt: 1L

Use apenas com água destilada. Com função de vapor frio e quente. O vapor incorpora a função de vapor OZONE, que gera mais vapor de água tanto no vapor frio quanto no quente. Quando a água estiver abaixo do mínimo, o vapor será desligado automaticamente por segurança. Pode girar 120°

- » Tensão: 220-240 V
- » Frequência: 50-60Hz
- » Potência: 650 W
- » Capacidade de depósito: 1L



Sac 10 mini spatules pour crème transparentes
Embalagem 10 mini espátulas para creme transparentes

1 u.m.vta
100 box

REF.07328

NEW



Brosse nettoyage et massage
Escova facial massagem

- » Idéal pour l'exfoliation
- » Ideal para esfoliação

1 u.m.vta
12 box

REF.01811

- » Avec capuchon de protection des poils en nylon doux.

1 u.m.vta
50 box

REF.06660

- » Com tampa protetora das puas em nylon suave.



Pinces (Extracteurs) Anti Points Noirs
Pinça de limpeza

- » Dissolvant de grande taille

- » Verniz grande

1 u.m.vta
50 box

REF.01477

- » Dissolvant de petit taille

- » Verniz pequeno

1 u.m.vta
50 box

REF.01478

- » Double usage

- » Dupla

1 u.m.vta
40 box

REF.01479



16,5 cm



16 cm



13,5 cm

Éponges konjac

Esponjas konjac



Des éponges de texture extra fine et fabriquées à partir des racines de konjac, riches en minéraux. Il est 100% naturel, biodégradable + durable + respectueux de l'environnement. Sans colorants, conservateurs et pigments artificiels. Antimicrobien grâce à sa nature alcaline, il a une grande capacité à nettoyer la peau. Avec l'utilisation de l'éponge, il n'est pas nécessaire d'utiliser du savon ou des nettoyants, puisque l'éponge seule a la capacité d'enlever toute la saleté et les impuretés de la peau.

Esponjas de textura extra fina e feitas a partir das raízes do konjac, rico em minerais. É 100% natural, biodegradável + sustentável + respeitosa com o meio ambiente. Sem corantes, conservantes e pigmentos artificiais. Antimicrobiano graças à sua natureza alcalina, tem grande capacidade de limpar a pele. Com o uso da esponja, não é necessário usar sabão ou produtos de limpeza, uma vez que a esponja sozinha tem a capacidade de remover toda a sujeira e impurezas da pele.



REF.04970



Charbon de bambou naturel

- » Il élimine l'excès de sébum, exfolie en douceur, nettoie en profondeur les pores qui peuvent causer des bactéries responsables de l'acné
- » Élimine les points noirs laissant derrière un film pour nourrir et améliorer la barrière protectrice de la peau, sans avoir besoin d'utiliser des abrasifs chimiques
- » Équilibre le pH de la peau. Particulièrement indiqué pour les peaux grasses et à tendance acnéique
- » Ne convient pas aux peaux sensibles.
- » L'éponge doit être remplacée tous les 2 mois.

Carvão vegetal de bambu natural.

- » Remove o excesso de sebo, esfolia suavemente, limpa poros em profundidade que podem causar bactérias que causam acne
- » Elimina os pontos negros deixando para trás um filme para nutrir e melhorar a barreira protetora da pele, sem a necessidade de usar abrasivos químicos
- » Equilibra o pH da pele. Especialmente indicado para pele oleosa e com tendência acnéica
- » Não é adequado para peles sensíveis.
- » A esponja deve ser substituída a cada 2 meses.



REF.04971



Aloe vera Apaisant, hydratant et hydratant

- » Équilibre le pH de votre peau
- » Laissez un film pour nourrir et améliorer le
- » Barrière protectrice de la peau.
- » Il aidera à apaiser et hydrater la peau
- » Idéal pour les peaux normales et mixtes
- » L'éponge doit être remplacée tous les 2 mois.

Aloe vera Calmante, hidratante e hidratante

- » Equilibra o pH da sua pele
- » Deixe um filme para nutrir e melhorar a barreira protetora da pele
- » Ajudará a acalmar e hidratar a pele
- » Ideal para pele normal e mista
- » A esponja deve ser substituída a cada 2 meses.



REF.04972



Graines de roses bulgares. Hydrate, nourrit et régénère

- Laissez un film qui hydrate, nourrit et améliore la barrière protectrice de la peau
- Réduit le besoin d'utiliser des savons Ils peuvent irriter votre peau délicate
- Il a un effet calmant naturel
- Particulièrement adapté pour les peaux très sensibles et même aux premiers âges
- » L'éponge doit être remplacée tous les 2 mois.

Sementes de rosas búlgaras. Hidrata, nutre e regenera

- » Deixe um filme que hidrata, nutre e melhora a barreira protetora da pele
- » Reduz a necessidade de usar sabonetes que podem irritar sua pele delicada
- » Tem um efeito calmante natural
- » Especialmente adequado para peles sensíveis
- » A esponja deve ser substituída a cada 2 meses.

02

Ligne de soins corporels

LINHA DE CUIDADOS CORPORAL

Crèmes, traitements, accessoires...

Crèmes, tratamento, acessórios...



Huiles de base · Óleos base

Les huiles de base sont également connues en tant qu'huiles de support ou huiles de véhicules. Ils agissent en tant que porteurs (véhicules) dans l'application des huiles essentielles sur le visage et le corps, en facilitant le mouvement nécessaire dans le massage en raison de la lubrification qu'ils offrent et, en même temps, fournissent les propriétés thérapeutiques propres au mélange. Ce sont des huiles fixes, c'est-à-dire qu'elles ne s'évaporent pas (contrairement aux huiles essentielles). Enrichi avec de l'huile de pépin de raisin. Propriétés, hautement émoullient, protecteur, idéal comme véhicule de pénétration pour d'autres composants lorsqu'il est combiné avec divers ingrédients actifs. En raison de sa teneur élevée en antioxydants, vitamines C, D, E et Betacarotène, il augmente la résistance de la peau, ce qui le rend plus élastique. Il est absorbé très rapidement et peut être utilisé sur n'importe quel type de peau.

Os óleos básicos são também conhecidos como óleos transportadores ou óleos veiculares. Eles atuam como veículos na aplicação de Óleos Essenciais no rosto e no corpo, facilitando o movimento necessário na massagem devido à lubrificação que oferecem e, ao mesmo tempo, proporcionam as propriedades terapêuticas próprias da mistura. São óleos fixos, não evaporam (ao contrário dos essenciais). Enriquecido com óleo de pimenta. Propriedades altamente protetoras, emolientes, ideais como veículo de penetração para outros componentes quando combinadas com vários ingredientes ativos. Devido ao seu alto teor de antioxidantes, vitaminas C, D, E e Betacarotene, aumenta a resistência da pele, tornando-a mais elástica. É absorvido muito rapidamente e pode ser usado em qualquer tipo de pele.

**Huile de base calendula**
Óleo base calêndula

Il a des propriétés anti-inflammatoires et apaisantes, donc après avoir soumis la peau à des traitements agressifs tels que l'épilation à la cire ou l'exfoliation, l'utilisation de l'huile produit une sensation de relaxation et de soulagement des rougeurs. Grand pouvoir hydratant, nourrissant et nettoyant. Particulièrement utile pour les peaux sensibles comme les bébés ou les personnes qui souffrent d'une irritation constante. Convient aux peaux sèches ou très sèches. Riche en vitamine E. Il peut être utilisé directement comme démaquillant, en particulier dans les peaux très sensibles qui irritent facilement.

Tem propriedades anti-inflamatórias e calmantes, por isso, depois de submeter a pele a tratamentos agressivos, como a depilação com cera ou esfoliação, o uso de óleo produz uma sensação de relaxamento e alívio. Grande poder hidratante, nutritivo e purificador. Especialmente útil para peles sensíveis, como bebês ou pessoas que sofrem irritação constante. Adequado para pele seca ou muito seca. Rico em Vitamina E. Pode ser usado diretamente como removedor de maquiagem, especialmente em peles muito sensíveis que irritam facilmente.



1 L

REF.06036

Huiles de base · Óleos base

Huile de base d'amande douce
Óleo base amêndoa doce

1 L

REF.06037

L'huile d'amande douce est l'une des huiles par excellence pour le massage. Propriétés: donne élasticité et douceur à la peau. Bonne pénétration dans la peau, ne laissant pas la peau grasse. Nutritif et régénérateur. Convient à tous les types de peau, y compris les enfants et les personnes âgées. Idéal pour les peaux fragiles ou craquelées. Renforceur de cheveux faibles, aide à la disparition des écailles sur le cuir chevelu. C'est un hydratant et un régénérateur de cils naturels.

O óleo de amêndoa doce é um dos óleos por excelência para a massagem. Propriedades: dá elasticidade e maciez à pele. Boa penetração na pele, não deixa a pele oleosa. Nutritivo e regenerativo. Adequado para todos os tipos de pele, incluindo crianças e idosos. Ideal para peles frágeis ou rachadas. Fortalecedor de cabelos fracos, ajuda o desaparecimento de escamas no couro cabeludo. É um hidratante natural para os cílios e regenerador

**Huile de base rose musquée**
Óleo base rosa mosqueta

1 L

REF.06035

Rose musquée est un excellent régénérateur de peau. Il agit superficiellement comme un facteur hydratant naturel, améliorant l'hydratation. Nourrit et régénère visiblement réduisant les cicatrices et les rides. Corrige et prévient les problèmes de peau dus au photo-vieillessement, grâce à l'auto-génération de mélanine. Il contribue à redistribuer la pigmentation permettant d'atténuer ou d'éliminer les taches. Action tonifiante, cicatrisante, rajeunissante et prévient l'oxydation des cellules.

Rosa Mosqueta é um ótimo regenerador de pele. Atua superficialmente como um fator natural de hidratação, melhorando a hidratação. Nutre e regenera visivelmente reduzindo cicatrizes e rugas. Corrige e previne problemas de pele devido ao fotoenvelhecimento, através da autogeração da melanina. Contribui para redistribuir a pigmentação, permitindo que as manchas sejam atenuadas ou eliminadas. Ação tonificante, cura, rejuvenescimento e impede a oxidação das células.

**Huile de base jojoba**
Óleo base jojoba

1 L

REF.06038

Excellente pénétration dans la peau ne laissant pas la peau grasse en raison de sa bonne capacité d'absorption. Recommandé pour les peaux grasses ainsi que pour le traitement anti-acné pour ses propriétés bactéricides, en tant que traitement anti-séborrhéique, dissout le sébum qui se dépose dans les follicules pileux actifs, obstruant la croissance des cheveux. Excellente huile capillaire car elle nourrit les cheveux secs et cassants. Il agit comme un protecteur contre les irritations possibles ou les changements de peau provoqués par des colorants et des permanentes.

Excelente penetração na pele, não deixa a pele oleosa devido à sua boa capacidade de absorção. Recomendado para pele oleosa e para tratamento anti-acne devido às suas propriedades bactericidas, como o tratamento anti-seborréico, dissolve o sebo que é depositado nos folículos capilares ativos, obstruindo o crescimento do cabelo. Excelente óleo capilar, pois nutre os cabelos secos e quebradiços. Atua como um protetor contra possíveis irritações ou alterações na pele causadas por corantes e permanentes.



Huiles de base · Óleos base

Huile de base d'arbre à thé
Óleo base árvore do chá

Fondamentalement, les applications sont fondamentalement en plus des propriétés bactéricides et antiseptiques, il a un anesthésique local avec un effet doux. Ses propriétés: Cicatrizante, dermoprotecteur, agit directement sur la dégradation de la sueur, dermopurifiante, eczéma, plaies, taches sur le visage, mains, décolleté. Drainant et amincissant. Il a également été utilisé pour les cuticules hachées ont été retirés pour leur action antiseptique.

Suas aplicações baseiam-se basicamente em suas propriedades antibacterianas e anti-sépticas, às quais se associa um efeito anestésico local moderado. Suas propriedades: Cicatrizante, dermoprotetor, atua diretamente na degradação do suor, dermopurificante, eczema, feridas, manchas no rosto, mãos, decote. Drenagem e emagrecimento.



1 L

REF.06051

Huile de base d'olive
Óleo base oliva

Propriétés émoullientes, antioxydantes, tonifiantes, hydratantes et apaisantes. Il a un profil lipidique très similaire à celui de la peau humaine. Rétablit l'hydratation et la fonction de barrière cutanée, favorisant la régénération cellulaire. Son application sur la peau agit comme une réparation émoulliente et protège contre le vieillissement prématuré. Activité antimicrobienne et antibactérienne.

Propriedades emolientes, antioxidantes, tonificantes, hidratantes e calmantes. Tem um perfil lipídico muito semelhante ao da pele humana. Restaura a unidade e a função barreira cutânea favorecendo a regeneração celular. Sua aplicação na pele atua como um emoliente reparador e protetor contra o envelhecimento precoce. Atividade antimicrobiana e antibacteriana.



1 L

REF.06039

Huile de base d'argan
Óleo base argão

Il contient des antioxydants tels que la vitamine E et est riche en acides gras. Régénérant, raffermissant les tissus car il renforce les fibres de collagène et d'élastine, améliore la barrière cutanée permettant de réduire la perte d'hydratation, anti-inflammatoire à utiliser après exposition solaire, nutritive et régénératrice. Grâce à son contenu en tocophérols il a un grand pouvoir antioxydant, agissant en profondeur dans la malnutrition de la peau. Idéal pour les cheveux et les ongles car il leur donne brillance et renforce grâce à leur grande capacité nutritionnelle.

Contém antioxidantes como a vitamina E, é rica em ácidos graxos. Regeneração, endurecimento dos tecidos, uma vez que reforça as fibras de colágeno e elastina, melhora a barreira cutânea da pele, permitindo a redução da perda de hidratação, anti-inflamatório para uso após a exposição ao sol, nutritivo e regenerativo. Graças ao seu conteúdo em tocoferóis, possui um grande poder anti-oxidante, atuando em profundidade na desnutrição da pele. Ideal para cabelos e unhas, pois lhes dá brilho e fortalece através de sua alta capacidade nutricional.



1 L

REF.06040

Exfoliant corps
Exfoliante corporal1
u.m.vta20
box

250 ml

REF.06648

Huile d'argan et noyau d'abricot.

Huile d'argan et noyau d'abricot. L'utilisation de l'exfoliant corporel aide à faire glisser les cellules mortes de la peau qui s'accumulent malgré le nettoyage, empêchant une oxygénation adéquate. Adoucit la peau qui apparaît plus lisse et plus brillante, la préparant à recevoir des traitements spécifiques dont les actifs vont mieux pénétrer après l'exfoliation. Arôme fruité agréable.

Il peut être utilisé comme un gommage régulier du corps en raison des propriétés naturelles et douces du noyau d'abricot.

Ne convient pas aux peaux sensibles.

Óleo de Argão e caroço de damasco.

Óleo de Argão e caroço de damasco. O uso do exfoliante corporal ajuda a remover as células mortas da pele que se acumulam apesar da limpeza impedindo a sua correta oxigenação.

Suaviza a pele, tornando-a mais firme e luminosa, preparando-a para receber os tratamentos específicos cujos princípios ativos penetrarão melhor após a exfoliação. Agradável aroma frutado.

Pode usar-se como exfoliante corporal habitual pelas propriedades naturais e suaves do caroço de damasco.

Não é adequado para peles sensíveis.

**Kit exfoliant avec éponge en caoutchouc en cadeau**
Kit exfoliante com esponja de borracha como presente1
u.m.vta12
box

REF.04883

Comprend
IncluiREF.06071
REF.06648
REF.04590

Anticellulite effet de chaleur
Anti-celulíticos efeito calor1 u.m.vta
25 box

250 ml

REF.03546

1 u.m.vta
12 box

500 ml

REF.03547

**Raffermissante et remodelante**
Reafirmante modelador1 u.m.vta
20 box

250 ml

REF.03932

1 u.m.vta
5 box

500 ml

REF.03931

**Sels de la Mer Morte, Aloe vera et Huile d'Argan**

Pour ses actifs Sels de la Mer Morte. La combinaison adéquate d'algues aussi puissantes que LAMINARIA et FUCUS, avec Ruscus, Iodine Extensine, la caféine entre autres, permet de dégrader et de mobiliser l'accumulation graisseuse (lipolyse). L'activation de la circulation et l'élévation localisée de la température créent les conditions nécessaires au développement de ces processus, convertissant cette crème en un produit idéal pour le traitement de la Cellulite et du Volume. L'huile d'argan et l'Aloe Vera ont des propriétés restructurantes et régénérantes.

EFFET DE CHALEUR. Masser et surtout l'utiliser dans les zones à traiter (fesses, hanches, cuisses, etc.). Elle Combat également la soi-disant "peau d'orange". Elle Active la microcirculation. Non recommandée pour les peaux sensibles.

Sais do Mar Morto, Aloé Vera e Óleo de Argão

Seus ativos Sais do Mar Morto. A combinação adequada de algas tão poderosas como LAMINARIA e FUCUS, com Ruscus, Iodine Extensine, Cafeína entre outras, permite degradar e mobilizar o acúmulo de gordura (lipólise). A ativação da circulação e a elevação localizada da temperatura criam as condições necessárias para o desenvolvimento desses processos, convertendo este creme em um produto ideal para o tratamento da celulite. O óleo de argão e Aloe Vera, tem propriedades de reestruturação e regeneração.

EFEITO CALOR. Massajar especialmente nas zonas mais problemáticas (nádegas, coxas, pernas, etc.). Combate também a chamada "Pele casca de laranja". Ativa a microcirculação. Não recomendada para peles sensíveis.

Extrait de citron, de collagène et d'algues.

Raffermit la peau en stimulant l'activité cellulaire, améliore l'élasticité et la fermeté. Aide à éliminer les toxines et remodèle la silhouette. Masser pour la faire pénétrer dans la zone à traiter.

Extrato de limão, Colagénio e Algas

Extrato de limão, Colagénio e Algas. Reafirma a pele estimulando a atividade celular, melhora a elasticidade e a firmeza. Ajuda a eliminar toxina e modela a silhueta. Massajar e incidir nas zonas problemáticas.

Sels de la mer morte, algues, extrait de citron**Sais do mar morto, algas, extrato de limão**

Pour des traitements visant à réduire l'aspect et l'intensité de la cellulite ou de la «peau d'orange», nous avons des traitements raffermissants, tonifiants et réducteurs. Tous avec des produits naturels tels que les sels de la mer morte, les algues ou l'extrait de citron. Avec l'aide de massages circulaires dans les zones à traiter, nous aiderons pour l'absorption du produit.

Para tratamentos de ajuda na redução do aspeto e da quantidade de celulite ou "Pele casca de laranja", dispomos de tratamentos reafirmantes, tonificantes e redutores. Todos com produtos naturais tais como sais do Mar Morto, algas ou extrato de limão. Ao fazer massagens circulares nas zonas mais problemáticas ajudaremos a pele na absorção do produto.



Huile d'argan + aloe vera

Óleo de argão + aloé vera



L'huile d'argan pénètre rapidement dans la peau en la laissant hydratée et sans excès de graisse. L'Arganier (*Argania Spinosa*), qui pousse uniquement dans le sud-ouest du Maroc, est par nature un arbre unique au monde. L'huile est extraite sans aucune utilisation de produits chimiques, c'est un produit biologique aux bénéfices avérés. Les analyses chimiques réalisées confirment ses précieuses propriétés dermatologiques et la combinaison avec l'Aloe Vera renforce les effets cicatrisants et régénérateurs.

O Óleo de Argão penetra rapidamente na pele deixando-a hidratada e não oleosa. A árvore de Argania Spinosa, que cresce apenas no sudoeste de Marrocos, é pelas suas características, uma árvore única no mundo. O Óleo é extraído sem a utilização de produtos químicos, é um produto biológico com benefícios demonstrados. As análises químicas realizadas confirmam as suas valiosas propriedades dermatológicas e a combinação com o Aloé Vera faz com que se potenciem os efeitos cicatrizantes e regenerativos.

Lotion hydratante corporelle

Loção hidratante leite corporal

Huile d'argan et aloe vera

Grâce à l'Huile d'Argan et à l'Aloe Vera qui apportent douceur, hydratation et grand effet régénérant à la peau, la renforcent et la préparent au stress quotidien, de sorte que son utilisation continue aide à réguler et prévenir l'apparition de flaccidité et de signes de vieillissement. D'une absorption rapide. Particulièrement indiquée pour les peaux sèches.

Óleo de argão e aloé vera

Graças ao Óleo de Argão e ao Aloé Vera que proporcionam suavidade, hidratação e um grande poder de regeneração à pele fortalecendo-a e preparando-a para o stress diário, de tal forma que o seu uso contínuo ajuda a regular e a evitar a flacidez e sinais de envelhecimento. De rápida absorção. Especialmente indicada para peles secas.

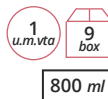

REF.04459

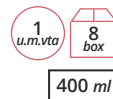

REF.04458



Éponge de boue pour le corps Esponja mud corporal

1
u.m.vta

12
box

» Petite
» Pequena

REF.03169

» Grande
» Grande

REF.03170



- » Éponge de boue corporal petite - grande
- » Spécial pour enlever les traitements de boue
- » Ils sèchent et durcissent pour empêcher la formation de germes
- » Douceur extraordinaire et longue durée

- » Esponja Corporal pequena - grande
- » Especial para remover tratamentos de lama
- » Secam e endurecem para evitar a formação de germes
- » Suavidade extraordinária e de longa duração

Medisana vibration du bâton de massage et lumière rouge Medisana massagem vibração com luz vermelha

1
u.m.vta

4
box

- » Massage agréable par vibration
- » Possibilité de régler différents angles de massage
- » Comprend 5 accessoires de massage interchangeables
- » La lumière rouge et la chaleur peuvent également être connectées
- » 2 niveaux d'intensité de massage réglable
- » Conception pratique pour un auto-massage confortable

- » Massagem agradável por vibração
- » Possibilidade de ajustar diferentes ângulos de massagem
- » Inclui 5 acessórios de massagem intercambiáveis
- » Luz vermelha e calor adicionalmente conectável
- » 2 níveis de intensidade de massagem ajustável
- » Design prático para auto-massagem confortável



Liquide de traitement de bandage froid

Líquido de tratamento com bandagem fria



1 L

REF.07012

RELAXANT - RAFRAÎCHISSANT - DESCONGESTIONANTE - ANTICELULITICO
Mélange: 1 partie de bandages froids liquides + 3 parties d'eau
Lotion cosmétique aux principes actifs Végétaux (Fucus, Ivy, Aquifolium)
et hypothermiques qui produisent un refroidissement local de la
température dans la zone traitée pendant un temps contrôlé.

MODE D'EMPLOI:

Mélanger une partie de la lotion avec 3 parties d'eau et faire tremper les
bandages dans le mélange, en enveloppant avec eux la zone à traiter.
Gardez 30 à 45 minutes et ne prenez pas de douche dans environ 2
heures. Utiliser deux ou trois fois par semaine

RELAXANTE - REFRESCANTE - DESCONGESTIONANTE - ANTICELULITICO

Ação redutora Ingredientes ativos vegetais e hipotérmicos

CONCENTRADO 1 x 3

Mistura: 1 parte de ataduras frias líquidas + 3 partes de água

Loção cosmética com ingredientes ativos Vegetal (Fucus, Ivy, Aquifolium)
e hipotérmica que produz um resfriamento local da temperatura na área
tratada durante um tempo controlado.

MODO DE EMPREGO:

» Misture uma parte da Loção com 3 partes de água e deixe de molho
os curativos na mistura, envolvendo com eles a área a ser tratada.
Mantenha 30 a 45 minutos e não tome banho em cerca de 2 horas. Use
duas ou três vezes por semana



Rouleau de bandages froids 15x10 crêpes

Rolo bandas frias 15x10 crepe



REF.07108



Fabriqué en crêpe épais et élastique pour les traitements
de bandage à froid et les traitements de compression. Faire
tremper les bandages dans le liquide de bandage froid (07012)
pour faire un traitement anti-cellulite, anti-inflammatoire, etc.

Feito de tecido crepe espesso e elástico para tratamentos de
bandagens frias e tratamentos de compressão. Mergulhe as
bandagens no líquido de bandagem fria (07012) para fazer um
tratamento anticelulite, anti-inflamatório, etc.

Rouleau de bandages froids 10x10 crêpes

Rolo bandas frias 10x10 crepe



REF.03041



Bandage élastique à la fois longitudinal et transversal.
Composition: coton: 93,84%, élastomère enrobé: 6,2%
Qualité supérieure Bandage de tricot de chaîne sur les côtés.
Idéal pour les traitements corporels.

Atadura elástica longitudinal e transversal.
Composição: Algodão: 93,84%, elastômero revestido: 6,2%
Qualidade superior Bandagem de tecido de malha de urdidura
em seus lados. Ideal para tratamentos corporais.

Brosse de bain de couleurs
Luva/esponja diferentes cores

12
u.m.vta

96
box



REF.01916



Gant de CRIN
Luva/esponja CRIN

1
u.m.vta

20
box

REF. 01084



Grande éponge de bain / massage en caoutchouc, de couleurs
Esponja banho/massagem de borracha, grande diferentes cores

» Grande
» Grande

1
u.m.vta

16
box



REF. 04591



» Petite
» Pequena

1
u.m.vta

24
box



REF. 04590



Brosse de bain en bois, fibre naturelle
Escova banho madeira, fibra natural

1
u.m.vta

12
box

REF. 00526

» Poil de cheveux. Bouton en bois
» Cerdas naturais. Botão de madeira



Brosse de bain de couleurs
Escova banho cores

1
u.m.vta

15
box

REF. 00679

» Cheveux nylon
» Cerdas nylon



03

Épilation

DEPILAÇÃO

Cire kg, roll-on de cire, chauffe cire, accessoires, pince à épiler...

Cera kg, cera roll-on, cera melters, acessórios, pinças depilam...



Sachet 1 Kg de Disques en cire
1 Kg discos cera

L'épilation avec des cires à bas point de fusion est très efficace pour l'épilation. Sa formulation spéciale à base de cire d'abeille naturelle et de colophane de haute qualité prépare la peau en adoucissant les pores. Son adhésion est totale, donc il extrait les cheveux de la racine, retardant ainsi son apparition. Pour obtenir une consistance élastique et crémeuse à température ambiante, certaines de nos cires sont à base de dioxyde de titane. De cette manière, nous atteignons un point de fusion plus bas qui favorise l'épilation. Prix échelonnés combinables à partir de la boîte de 6 unités avec toutes les références en page 557.

Depilação com ceras de baixo ponto de fusão é muito eficaz na remoção de pêlos. Sua formulação especial baseada em cera natural de abelha e resina de alta qualidade prepara a pele suavizando o poro. Sua adesão é total para extrair o cabelo da raiz, retardando sua aparência. Para obter uma consistência cremosa e elástica à temperatura ambiente, algumas de nossas ceras são feitas com dióxido de titânio. Desta forma, conseguimos um ponto de fusão mais baixo que favorece a depilação. Preços em escala combináveis a partir da caixa de 6 unidades com todas as referências na página 557.



1 kg

REF.04675

- » Disques de cire **brésilienne**
- » Bidirectionnel
- » Extra-flexible
- » N'a pas besoin de bandes de papier

- » Discos de cera **brasileiros**
- » Bidirecional
- » Extra flexível
- » Não precisa de bandas de papel

- » Miel
- » Mel

1 kg

REF. 03916



- » Pour peaux sensibles au dioxyde de titan
- » Peles sensíveis com dióxido de titânio

1 kg

REF. 03917



- » Disques en cire de Aloe Vera
- » Discos cera Aloe Vera

1 kg

REF. 03918



- » Disques de cire d'huile d'argan
- » Discos cera Óleo de Argão

1 kg

REF. 03919



- » Cacao
- » Cocoa

1 kg

REF. 03920



- » "Azuleno"
- » "Azuleno"

1 kg

REF. 04260



Sachet 1 kg de cire fabriqué en Espagne
1 kg de cera feita na Espanha



Zone de traitement: aisselles, bras, lèvre supérieure, facial, corps. Choisissez celui qui s'adapte le mieux en fonction de son élasticité, au type de poil et de peau: transparent, élastique, en couleur, parfumé, faible fusion, etc.

Prix échelonné combinable avec l'une des références à la page 558-559.

Área de tratamento: axilas, braços, lábio superior, facial, corporal. Escolha o que melhor se adapte de acordo com a sua elasticidade, ao tipo de pelo e pele: transparente, elástico, com cor, perfumado, baixo derretimento, etc.

Preço em escala combinável com qualquer uma das referências na página 558-559.

Disques en cire rose - élasticité double supérieure
Discos cera rosa- elasticidade superior dupla



Flexibles, ils permettent d'appliquer une fine couche réduisant la sensation de chaleur. La cire classique, spéciale pour le rasage anglais et les aisselles.

Flexíveis, permitem aplicar uma capa fina reduzindo a sensação de calor. A cera clássica, especial para barbear e axilas.



1 kg

REF.06323

Disques en cire verte - élasticité supérieure
Discos cera verde - maior elasticidade



Transparent ou semi-transparent, avec une texture fluide, un départ fort et un séchage rapide. Léger et cristallin, adapté à toutes les zones du corps.

Transparente ou semitransparente, com uma textura fluida, forte arranque e secagem rápida. Leve e cristalino adequado para qualquer área do corpo.



1 kg

REF.06324

Disques en cire de bleus - élasticité supérieure
Discos cera azul - maior elasticidade



Transparent ou semi-transparent, avec une texture fluide, un départ fort et un séchage rapide. Léger et cristallin, adapté à toutes les zones du corps.

Transparente ou semitransparente, com uma textura fluida, forte arranque e secagem rápida. Leve e cristalino adequado para qualquer área do corpo.



1 kg

REF.06325

Sachet 1 kg de cire fabriqué en Espagne
1 kg de cera feita na Espanha



Zone de traitement: anglais, aisselles, bras, lèvre supérieure, facial, corps. Choisissez celui qui s'adapte le mieux en fonction de son élasticité, au type de poil et de peau: transparent, élastique, en couleur, parfumé, faible fusion, etc.
 Prix échelonné combinable avec l'une des références à la page 558-559.

Área de tratamento: axilas, braços, lábio superior, facial, corporal. Escolha o que melhor se adapte de acordo com a sua elasticidade, ao tipo de pelo e pele: transparente, elástico, com cor, perfumado, baixo derretimento etc.
 Preço em escala combinável com qualquer uma das referências na página 558-559.

Disques en cire chocolat - élasticité triple supérieure
Discos cera chocolate - elasticidade tripla superior



Flexibles et élastiques, ils favorisent l'application et l'élimination des peaux douces et légèrement agressives. Épilation douce, laisse la peau légèrement parfumée.

Flexíveis e elásticos, favorecem a aplicação e remoção de pele macia e levemente agressiva. Suave depilação, deixa a pele levemente perfumada.



1 kg

REF.06328

Disques en cire vin - élasticité triple supérieure
Discos cera cor vinho - elasticidade tripla superior



Flexibles et élastiques, ils favorisent l'application et l'élimination des peaux douces et légèrement agressives. De couleur intense, il procure une épilation douce laissant la peau légèrement parfumée.

Flexíveis e elásticos, favorecem a aplicação e remoção. De cor intensa, proporciona uma depilação suave deixando a pele levemente perfumada



1 kg

REF.06327

Disques en cire mauve - élasticité triple supérieure
Discos cera malva- elasticidade tripla superior



Flexibles et élastiques, ils favorisent l'application et l'élimination des peaux douces et légèrement agressives. De couleur intense, il est idéal pour les cheveux de l'homme pour son grand pouvoir de départ.

Flexíveis e elásticos, favorecem a aplicação e remoção. De cor intensa, é ideal para o cabelo do homem por seu grande poder de partida.



1 kg

REF.06326

Boîte disques cire d'Aloe Vera
Caixa 20 discos cera Aloe Vera

L'épilation avec des cires à bas point de fusion est très efficace pour l'épilation. Sa formulation spéciale à base de cire d'abeille naturelle et de colophane de haute qualité prépare la peau en adoucissant les pores. Son adhésion est totale, donc il extrait les poils de la racine, retardant ainsi leur apparition. Pour obtenir une consistance élastique et crémeuse à température ambiante, certaines de nos cires sont à base de dioxyde de titane. De cette manière, nous atteignons un point de fusion plus faible qui favorise l'épilation. Prix évolutif combinable avec la page 560.

Depilação com ceras de baixo ponto de fusão é muito eficaz na remoção de pêlos. Sua formulação especial baseada em cera natural de abelha e resina de alta qualidade prepara a pele suavizando o poro. Sua adesão é total para extrair o pelo da raiz, retardando sua aparência. Para obter uma consistência cremosa e elástica à temperatura ambiente, algumas de as nossas ceras são feitas com dióxido de titânio. Desta forma, conseguimos um ponto de fusão mais baixo que favorece a depilação. Preço escalável combinável com a página 560.

400 gr

REF. 04070

» d'Aloe Vera
» Aloe Vera

400 gr

REF. 04071

» Miel
» Mel

400 gr

REF. 04072

» Peau sensible
» Pele sensível

Boîte de cire miel
Bandeja Cera Mel

 » Miel
 » Mel

500 gr

 » Chlorophylle
 » Clorofila

500 gr

REF. 03722

REF. 03726

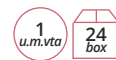
Bidon de cire
Lata cera

400 gr

 Peau sensible
 Pele sensível

REF.04563

400 gr

 Miel
 Mel

REF.03728

400 gr

 d'Aloe Vera
 Aloe Vera

REF.04735

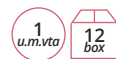

800 gr

 Peau sensible
 Pele sensível

REF.04565

800 gr

 Miel
 Mel

REF.04564

800 gr

 d'Aloe Vera
 Aloe Vera

REF.04736



Chauffe cire électrique d'épilation Panela cera

- » Puissance: 80W
- » Avec thermostat
- » Sans bol
- » Convient aux boîtes de 400 et 500 gr

- » Potência: 80W
- » Com termostato
- » Sem recipiente
- » Adequado para latas de 400 e 500 gr



400 gr

REF. 03321



Pièce de rechange Paças de reposição

400 gr

REF. RE03321/02



- » Puissance: 80W
- » Comprend un bol de 800 g.
- » Chauffe rapidement la cire
- » Sûr et ergonomique
- » Petit format
- » Pour les disques, la cire ou les perles, utiliser un bol

- » Potência: 80W
- » Inclui panela de 800g.
- » Aquecimento rápido da cera.
- » Seguro e ergonômico
- » Leve e de dimensões reduzidas
- » Para discos, cera ou pérolas



800 gr

REF. 03322

Pièce de rechange Paças de reposição

800 gr

REF. RE03322/01



Chauffe cire électrique d'épilation Panela cera

- » Puissance: 80W
- » Avec thermostat
- » Comprend un bol de 45

- » Potência: 80W
- » Com termostato
- » Inclui recipiente de 450g.

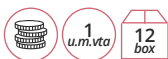

450 gr

REF. 03154



Collerettes de protection Círculo protector

- » Sachet de 100 collerettes de protection pot cire à épiler
- » Diamètre intérieur: 9,8cm
- » Diamètre extérieur: 16 cm
- » Diamètre intérieur maximum: 13,5 cm

- » Saco de 100 círculos protetor fundidor cera
- » Diâmetro interno: 9,8cm
- » Diâmetro externo: 16cm
- » Diâmetro interno máximo: 13,5cm

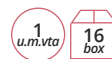

REF. 03716



Chauffes cire

Panela de cera



- » Puissance: 90W
- » Thermostat électronique de température
- » Réservoir en aluminium
- » Chauffage rapide de la cire
- » Sûr et ergonomique
- » Petit format
- » Bol inclus avec poignée amovible

- » Potência: 90W
- » Termóstato eletrônico de temperatura
- » Depósito de alumínio
- » Aquecimento rápido da cera
- » Seguro e ergonômico.
- » Leve e de reduzidas dimensões
- » Recipiente de metal com pega

Pièce de rechange

Peças de reposição



250 gr

REF. RE03612/01



250 gr

REF. 03612



Chauffe cire Pollié avec thermostat

Panela cera Pollié com termóstato



- » Puissance: 40W
- » Cire 125 ml. Compacte, idéale épiler les petites zones telles que le nez, les oreilles, les sourcils et le contour de la barbe.

- » Potência: 40W
- » Fusor cera 125 ml. Ideal compacto para depilação de pequenas áreas, como nariz, orelhas, sobrancelhas e contorno de barba.



125 gr

REF. 06614/58

125 gr

REF. 06614/70

Pièce de rechange · Peças de reposição

- » Bol cire pour chauffe
- » ref. 06614/58, 06614/70 et 04505
- » Recipiente de cera para panela
- » ref. 06614/58, 06614/70 e 04505



125 gr

REF. RE06614/01

Appareils chauffe-cire électrique**Panela cera**

Idéal pour l'utiliser avec des disques de cire
 Ideal para utilizar com discos de cera



- » Puissance: 125W
- » Avec thermostat en metal
- » Avec filtre

- » Potência: 125W
- » Com termóstato de metal
- » Com filtro

- » Puissance: 125W
- » Avec thermostat en metal
- » Avec filtre
- » Adapté pour les boîtes de 400 et 500 gr

- » Potência: 125W
- » Com termóstato de metal
- » Com filtro
- » Adequado para latas de 400 e 500 gr



250 gr

REF. 02905



400 kg

REF. 02928

- » Puissance: 250W
- » Avec thermostat en metal
- » Avec filtre

- » Potência: 250W
- » Com termóstato de metal
- » Com filtro



1 kg

REF. 02908

- » Puissance: 450W
- » Avec thermostat en metal
- » Avec filtre

- » Potência: 450W
- » Com termóstato de metal
- » Com filtro



4 kg

REF. 02900

Réchauffeurs de cire d'épilation avec 2 récipients connectés, et avec filtre pour filtrer la cire réutilisable. 2 thermostats indépendants pour chaque récipient.

Panela cera com 2 recipientes interligados e com filtro para filtrar cera reutilizável. 2 Termóstatos independentes para cada recipiente.

CHAUFFE-CIRE GRAND GRANDE PANELA CERA

Appareils chauffe-cire électrique Panela cera

Idéal pour l'utiliser avec des disques de cire
Ideal para utilizar com discos de cera



- » Puissance: 2 x 450W
- » Avec thermostats en metal
- » Avec filtre
- » Potência: 2 x 450W
- » Com termóstatos de metal
- » Com filtro



8 kg

REF. 02906

- » Puissance: 2 x 450W
- » Avec thermostats en metal
- » Avec filtre
- » Potência: 2 x 450W
- » Com termóstatos de metal
- » Com filtro



12 kg

REF. 04216

- » Puissance: 2 x 450W
- » Avec thermostats
- » Avec filtre
- » Potência: 2 x 450W
- » Com termóstatos de metal
- » Com filtro



20 kg

REF. 04217

Spatule pour épilation à la cire
Espátula cera12
u.m.vta 12
box» Mini
» Mini

REF.01627

» Petite
» Pequena

REF.01628

» Moyenne
» Média

REF.01630

» Grand
» Grande

REF.01632

» Súper grand
» Super grande

REF.01634

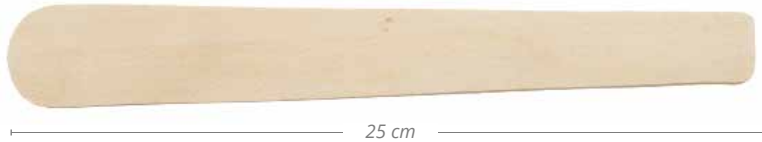
**Boîte de 100 spatules**
Pacote 100 espátulas

 1
u.m.vta 50
box

REF.07114

Sachet de 100 spatules
Pacote de 100 espátulas

 1
u.m.vta 100
box

REF.06651



 1
u.m.vta 50
box

REF.03282



Spatule spéciale pour l'épilation à la cire de 2 mm d'épaisseur
Espátula cera especial 2 mm de espessura1
u.m.vta 50
box

REF.01636

**Spatule pour l'épilation à la cire avec manche**
Espátula cera com cabo12
u.m.vta 12
box

REF.01629



REF.01631



REF.01633

Spatule Extra Flex en plastique
Espátula Extra Flex em plástico1
u.m.vta 12
boxEn plastique blanc rigide pour cire et tout type de traitement esthétique.
Cor branca. Material plástico rígido para cera ou qualquer tipo de tratamento estético.

REF.03229

REF.03230

**Spatule pour épilation à la cire en métal et en bois**
Espátula cera metálica com punho de madeira1
u.m.vta 12
box

REF.03469

REF.01419



Roll-on de Cire Fabriqué en Espagne Cera roll-on feita em Espanha



Zones de traitement: aisselles, poitrine, dos, bras, abdomen, jambes, visage et aine. Choisissez celui qui convient le mieux au type de cheveux et à la peau: transparent, ultra-crèmeux, coloré, parfumé, etc. Prix échelonnés combinables page 568.

Área de tratamento: axilas, tórax, costas, braços, abdome, pernas, rosto e virilha (roll-on facial). Escolha o que melhor se adequa ao tipo de cabelo e pele: transparente, ultra cremoso, com cor, perfumado, etc. Preços escalonáveis combináveis página 568.



Roll-on cire de natual - cristallin Roll-on cera natural - cristalino

Texture transparente ou semi-transparente, fluide et fort début. Son excellente combinaison de résines de pin le rend idéal pour une épilation parfaite.

Textura fluida transparente ou semitransparente, forte arranque. Sua excelente combinação de resinas de pinho torna-o ideal para uma depilação perfeita.



100 ml

REF.06317

Roll-on cire bleu- cristallin Roll-on cera azul- cristalino

Texture transparente ou semi-transparente, fluide et fort début. Convient à tous les domaines, même les plus sensibles..

Textura fluida transparente ou semitransparente e forte arranque. Adequado para todas as áreas, mesmo as mais sensíveis.



100 ml

REF.06318

Roll-on cire de rose - cremosa Roll-on cera rosa- cremosa

Texture transparente ou semi-transparente, fluide et fort début. Sa texture élastique facilite l'épilation dans tout type de cheveux.

Textura fluida transparente ou semitransparente e forte arranque. Sua textura elástica facilita a depilação em qualquer tipo de pelo.



100 ml

REF.06319

Roll-on cire de chocolat - cremosa Roll-on cera chocolate - cremosa

Texture crémeuse et élastique agréable pour un départ parfait. Pour une épilation douce et efficace, avec un arôme intense de chocolat.

Textura cremosa e elástica agradável para um começo perfeito. Para uma depilação suave e eficaz, com um aroma intenso a chocolate.



100 ml

REF.06320

Roll-on cire de or - pigments irisé Roll-on cera ouro - pigmentos irisé

Texture dense qui favorise l'adhésion et réduit la sensation de chaleur et de douleur. Grâce aux particules dorées, la cire maintient sa température, facilitant l'application et le démarrage.

Textura densa que promove a adesão e reduz a sensação de calor e dor. Graças às partículas de ouro, a cera mantém sua temperatura, facilitando a aplicação e partida.



100 ml

REF.06321

Roll-on cire de vin - cremosa Roll-on cera vinho - cremosa

Texture crémeuse et élastique agréable pour un départ parfait. Pour une épilation douce et efficace, laissant la peau légèrement parfumée.

Textura cremosa e elástica agradável para um começo perfeito. Para uma depilação suave e eficaz, deixando a pele ligeiramente perfumada.



100 ml

REF.06322

Roll-on de Cire

Roll-on cera



Le système d'épilation au rouleau est optimal pour les professionnels qui cherchent à obtenir de meilleurs résultats. Les résines avec lesquelles nous fabriquons les cires peuvent être utilisées à une température plus élevée que la cire de basse fusion, avec l'avantage d'être appliquées au moyen d'une bande plus mince. Ainsi, la cire refroidit presque instantanément et la sensation de chaleur dans la peau est minimisée. La cire s'enlève facilement avec les bandes hygiéniques. Prix échelonnés combinables page 569-570.

O sistema roll-on de depilação é ideal para aqueles profissionais que buscam obter os melhores resultados. As resinas com as quais fabricamos as ceras podem ser usadas a uma temperatura mais elevada do que a cera de baixo ponto de fusão, com a vantagem de serem aplicadas por meio de uma tira mais fina. Assim, a cera esfria quase instantaneamente e a sensação de calor na pele é minimizada. A cera é facilmente removida com as tiras higiênicas. Preços escalonáveis combináveis página 569-570.

» Roll-on de Cire au miel
» Roll-on Cera Mel

100 ml

REF.03704

» Roll-on de Cire talc avec du dioxyde de titane
» Roll-on Cera Talco com dióxido de titânio

100 ml

REF.03705



» Roll-on de Cire d'huile d'olive
» Roll-on Cera de Azeite

100 ml

REF.03739

» Roll-on de Cire d'Aloe Vera
» Roll-on Cera Aloé Vera

100 ml

REF.03740



» Roll-on de Cire pour Homme
» Roll-on Cera Homem

100 ml

REF.03858

» Roll-on de Cire à l'azulène
» Roll-on Cera Azuleno

100 ml

REF.04259



Roll-on de Cire
Roll-on cera

Le système d'épilation au rouleau est optimal pour les professionnels qui cherchent à obtenir de meilleurs résultats. Les résines avec lesquelles nous fabriquons les cires peuvent être utilisées à une température plus élevée que la cire de basse fusion, avec l'avantage d'être appliquées au moyen d'une bande plus mince. Ainsi, la cire refroidit presque instantanément et la sensation de chaleur dans la peau est minimisée. La cire s'enlève facilement avec les bandes hygiéniques. Prix échelonnés combinables page 569-570.

O sistema roll-on de depilação é ideal para aqueles profissionais que buscam obter os melhores resultados. As resinas com as quais fabricamos as ceras podem ser usadas a uma temperatura mais elevada do que a cera de baixo ponto de fusão, com a vantagem de serem aplicadas por meio de uma tira mais fina. Assim, a cera esfria quase instantaneamente e a sensação de calor na pele é minimizada. A cera é facilmente removida com as tiras higiênicas. Preços escalonáveis combináveis página 569-570.

» Roll-on de cire de coco
» Roll-on cera coco



100 ml

REF.04678

» Roll-on de cire de pomme
» Roll-on cera Maçã



100 ml

REF.04674

» Roll-on de Cire de Banane
» Roll-on cera banana



100 ml

REF.04677

» Roll-on de Cire de cacao
» Roll-on cera de Cacao



100 ml

REF.03748

» Roll-on de Cire de Argan
» Roll-on cera Argão



100 ml

REF.03706

» Roll-on de cire de rose pour les peaux sensibles au dioxyde de titane
» Roll-on cera rosa peles densíveis com dióxido de titânio



100 ml

REF.03749



100 ml

REF.03907

» Faciale
» Facial

Chauffe-cire roll on avec thermostat externe Aquecedor roll-on com termostato externo



REF. 04091

- » Puissance: 20W
- » Avec thermostat
- » Chauffe cire avec base pour la stabilité et l'utilisation facile
- » Fenêtre pour voir le niveau de la cire
- » Régulation de la température de 1 à 6
- » Câble de la base 2 mètres
- » Chauffage rapide et faible consommation
- » Couvercle de protection
- » Grâce à son design intérieur, il s'adapte à tout type de roll-on
- » Led indicatrice de chauffage
- » 100-240 V ~

- » Potência: 20W
- » Com termostato
- » Aquecedor com base para maior estabilidade e facilita a utilização
- » Indicador de nível de cera
- » Regulação da temperatura de 1 ao 6
- » Cabo da base de 2 metros
- » Aquecimento rápido e baixo consumo
- » Tampa protetora
- » Graças ao seu design interior adapta-se a qualquer tipo de roll-on
- » Led indicador de aquecimento
- » 100-240V~

Réchauffeur roll-on avec thermostat interne Aquecedor roll-on com termostato interno

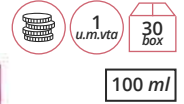

REF. 03379

- » Puissance: 15W
- » Avec thermostat
- » Chauffe cire roll-on avec afficheur latéral de niveau de cire
- » Conception ergonomique
- » Rapide pour atteindre la température optimale
- » Grâce à son design intérieur, il s'adapte à tout type de roll-on
- » Thermostat interne qui maintient la température idéale pour l'application de la cire.
- » LED Indicatrice de marche-arrêt
- » 100-240 V ~
- » 50/60 Hz

- » Potência: 15W
- » Com termostato
- » Aquecedor de cera roll-on com indicador lateral de nível de cera
- » Design ergonômico
- » Rápido em alcançar uma temperatura ideal
- » Graças ao seu design interior adapta-se a qualquer tipo de roll-on
- » Termóstato interno que mantém a temperatura ideal para a aplicação da cera
- » Led indicador de ligado e desligado
- » 100-240V~
- » 50/60Hz

Base chauffe roll on réf. 03379 Base roll-on réf. 03379

Câble: 1,6 m
Cabo: 1,6m

- » Puissance: 15W
- » 100-240V~



1 roll-on

REF. 03272

- » Puissance: 30W
- » 100-240V~

- » Potência: 30W
- » 100-240V~



2 roll-on

REF. 03273

- » Puissance: 45W
- » 100-240V~

- » Potência: 45W
- » 100-240V~



3 roll-on

REF. 03274



1 Chauffe-cire roll-on + 1 base chargeur avec base magnétique
1 Aquecedor de cera roll-on + 1 base carregador com base magnética



100 ml

REF. 06623



- » Puissance: 20W
- » Capacité: 100 gr
- » Fréquence: 50 Hz
- » Tension 220-240V~
- » Base connectable à d'autres bases (jusqu'à 5)
- » Fenêtre latérale pour voir le niveau de cire
- » Bouton régulateur de température (85°C max)
- » Léger et aux dimensions réduites
- » Avec capuchon de protection

- » Potência: 20W
- » Capacidade: 100 gr
- » Frequência: 50Hz
- » Voltagem: 220-240~
- » Base conectável a outras bases (até 5 bases)
- » Janela lateral para ver o nível de cera
- » Controlo regulador de temperatura (85°C máx.)
- » Leve e de reduzidas dimensões
- » Com tampa protetora



Kits d'épilation Pollié

Kits de depilação Pollié

Les trousse d'épilation sont idéales pour une épilation facile et confortable contient tout ce dont vous avez besoin pour une épilation professionnelle à domicile. Pour avoir de belles jambes toute l'année

Kits de depilação Pollié, ideal para uma depilação fácil e confortável, com tudo que você precisa para depilar profissionalmente em casa. Para pernas lindas o ano todo.



100 ml

REF.03310

Contient · Contém

REF. 03379

- » 1 chauffe-eau 15W
- » 1 aquecedor roll-on 15W



REF. 03706

- » 1 roll-on Argan
- » 1 argônio roll-on



REF. 02091

- » 1 paquet de 20 bandes d'épilation
- » 1 embalagem de 20 tiras de depilação



REF. 03855/01

- » 3 sacs de 5 serviettes de l'huile post-épilation
- » 3 sacos de 5 toalha de óleo pós-depilação



100 ml

REF.03925

Contient · Contém

REF. 04091

- » 1 chauffe-eau 20W
- » 1 aquecedor roll-on 20W



REF. 03706

- » 1 roll-on Argan
- » 1 argônio roll-on



REF. 02091

- » 1 paquet de 20 bandes d'épilation
- » 1 embalagem de 20 tiras de depilação



REF. 03855/01

- » 3 sacs de 5 serviettes de l'huile post-épilation
- » 3 sacos de 5 toalha de óleo pós-depilação





Pack 20 bandes de papier d'épilation POLLIÉ
Pacote 20 tiras papel depilação POLLIÉ

» 20 bandes
» 20 tiras



85 g/m²

REF.02091

» 100 bandes
» 100 tiras



80 g/m²

REF. 00929

» 100 bandes
» 100 tiras



90 g/m²

REF. 02556



» 100 bandes
» 100 tiras



80 g/m²

REF. 04207

» 100 bandes
» 100 tiras



80 g/m²

REF. 03804



Rouleau de papier d'épilation
Rolo papel depilar

» Largeur: 7 cm
» Longueur: 75 m

80 g/m²

REF. 06926

» Largura: 7 cm
» Comprimento: 75 m

» Largeur: 7 cm
» Longueur: 100 m

80 g/m²

REF. 03806

» Largura: 7 cm
» Comprimento: 100 m



Pack 100 de bandes de papier épilation ANONYMES
Pacote 100 tiras papel depilação ANÓNIMAS

» 100 bandes
 » 100 tiras



80 g/m²

REF. 00929/00

» 100 bandes
 » Extra-fort



90 g/m²

REF. 02556/00

» 10 bandes
 » 10 tiras



80 g/m²

REF. 03805



Boîte 100 bandes de papier d'épilation extra hypoallergénique
Caixa de 100 tiras papel depilação extra hipoaergénico



Fibres étroitement entrelacées qui confèrent au produit une résistance totale à la déchirure et agissent comme une barrière de sorte que la cire ne passe pas.

Fibras estreitamente entrelaçadas que dão ao produto uma resistência total e atuam como barreira para que a cera não trespasse.

» Extra : Avoir plus de densité ainsi qu'elle est plus forte et plus résistante.

» Extra: mais densidade é mais forte e resistente.

90 g/m²

REF. 06114



Gel post-épilation Gel pós-depilação

- » 99% d'aloë Vera
- » 99% Aloé Vera



500 ml

REF.03613



Huile de post-épilation Óleo pós-depilação

- » Avec rose musquée
- » Parfum de rose

- » Com Rosa Mosqueta
- » Perfume de rosa



500 ml

REF.03614



Lingettes nettoyantes à l'huile post-épilation Toalhitas óleo pós-depilação

- » Sachet de 5 lingettes
- » Bolsa de 5 toalhitas



2 ml

REF.03855



2 ml

REF.03855/01

Boîte de 20 bandes cire froide PEUX SENSIBLES Caixa 20 bandas de cera fria PELES SENSIVEIS

- » Bandes de corps
- » Bandas Corporais



REF.03717



- » Bandes faciales
- » Bandas faciais



REF.03718

Avec des extraits de fruits rouges
Com extratos de frutas vermelhas

Boîte 50 aiguilles d'épilation coniques

Caixa 50 agulhas depilação cónicas

1 u.m.vta
20 box



0,5 mm Inox

REF.02965

1 mm Inox

REF.02966

1,5 mm Inox

REF.02967

0,5 mm Oro-Gold

REF.02968

1 mm Oro-Gold

REF.02969

1,5 mm Oro-Gold

REF.02970

Aiguilles d'épilation inclinées

Agulhas depil. Inclinadas

- » Boîte de 50 aiguilles
- » Caixa 50 agulhas

1 u.m.vta
20 box

1 mm Inox

REF.03287



Nettoyant pour appareils à cire

Limpador de aparelhos de cera

1 u.m.vta
9 box

- » Dissolvent en spray
- » Pour cassolettes et chauffeuses

500 ml

REF. 03437

- » Dissolvente em spray
- » Painéis e aquecedores



Gel électroconducteur neutre

Gel de eletrocondutor neutro



Le gel de transmission par ultrasons TASSEL est indiqué pour améliorer la conductivité des ultrasons diagnostiques et thérapeutiques. Il est soluble dans l'eau, ne laisse pas de taches. Il peut être utilisé avec tous les appareils à ultrasons disponibles sur le marché. Il s'étale facilement, uniformément et sans se dessécher.

Le gel de transmission par ultrasons TASSEL est destiné à un usage externe sur une peau intacte et sans plaies cutanées. Appliquer le gel sur la zone à traiter. C'est un excellent agent conducteur pour la thérapie par ultrasons, l'imagerie diagnostique et l'épilation au laser.

O gel de transmissão por ultrassom TASSEL é indicado para melhorar a condutividade do ultrassom diagnóstico e terapêutico. É solúvel em água, não deixa manchas. Pode ser usado com todos os dispositivos ultrassônicos disponíveis no mercado. Ele se espalha facilmente, uniformemente e sem secar.

O gel de transmissão por ultrassom TASSEL destina-se ao uso externo em pele intacta e sem feridas. Aplique o gel na área a ser tratada. É um excelente agente condutor para terapia ultrassônica, diagnóstico por imagem e depilação a laser.

5 L

REF. 06694



Talco TASSEL

Talcum TASSEL



Talc parfumé extra-fin. Douceur, fraîcheur et nutrition pour la peau. Tassel Talc est adoucissant, hydratant et émollient. Idéal pour le rasage ou l'épilation, les irritations ou les éruptions cutanées, les rougeurs, l'exposition au soleil ou les lésions cutanées. Pas d'allergènes ni de parabens. Testé dermatologiquement.

- » Absorbe l'humidité
- » Garde la peau fraîche et sèche
- » Soulage la peau irritée
- » Adoucit

Pó de talco perfumado extra fino. Suavidade, frescura e nutrição para a pele. Talco em pó é suavizante, hidratante e emoliente. Ideal para após o barbear ou depilação, irritações ou erupções cutâneas, ao sol ou lesões na pele. Sem alérgenos e sem parabens. Testado dermatologicamente.

- » Absorve a umidade
- » Mantém a pele fresca e seca
- » Acalma a pele irritada
- » Suaviza

200 gr

REF. 06429



100 rasoirs jetables Pollié
100 navalhas descartáveis Pollié



REF. 02480



Sachet de 5 rasoirs de sécurité DERBY BODY
Pacote 5 barbeador DERBY BODY



REF.03828

- » Sachet de 5 rasoirs de sécurité, avec un peigne protecteur
- » Spécialement conçu pour enlever les poils du corps. Peigne de protection spécial pour un rasage plus facile et plus sûr pour les poil longs
- » Idéal pour le rasage avant l'épilation au laser
- » Recommandé dans les hôpitaux pour le rasage avant la chirurgie.

- » Bolsa de 5 barbeador, com pente protetor
- » Especialmente concebida para eliminar pelos do corpo, já que o pente protetor especial proporciona um barbear mais fácil e seguro para os cabelos mais compridos
- » Recomendada em hospitais para barbear prévio às cirurgias.
- » Cabeçal e cabo em material poliestireno



Sachet de 5 rasoirs de sécurité DERBY 2
Pacote 5 máquinas DERBY 2



REF.02948

- » 2 lames
- » 2 lâminas





Pincès à épiler SOLIGEN

Pinças de depilar SOLIGEN

12 u.m.vta
12 box



» Point de test
» Ponto de teste

Nickel

REF.01080



» Point de test
» Ponto de teste

Nickel

REF.00938



8 cm



8 cm



» Point de test
» Ponto de teste

Nickel

REF.00939



» Pointe plate
» Ponta plana

Inox

REF.02469



9 cm



9,5 cm



» Point de test
» Ponto de teste

Nickel

REF.01081



» Pointe oblique
» Ponta oblíqua

Inox

REF.02468



9 cm



9,5 cm



» Point de test
» Ponto de teste

Nickel

REF.00940



» Point fine
» Ponta fina

Inox

REF.02467



9 cm



9,5 cm



Pincès à épiler SOLIGEN
Pinças de depilar SOLIGEN

12
u.m.Vta

12
box



» Point de test
 » Ponto de teste

Nickel

REF.00937



» Point de test
 » Ponto de teste

Nickel

REF.01974



8 cm



8 cm



» Pointe oblique
 » Pointe oblique

Inox

REF.01404



» Pointe plate
 » Ponta plana

Inox

REF.01405



9,5 cm



9,5 cm



» Point fine
 » Ponta fina

REF.01403



» Point fine
 » Ponta fina

REF.01402



9,5 cm



9,5 cm

Pincès à épiler POLLIÉ
Pinças de depilar POLLIÉ

12
u.m.vta

12
box



» Pointe plate
 » Ponta plana

REF.01339



» Point de test
 » Ponto de teste

REF.02625



8,5 cm



9 cm



» Pointe plate
 » Ponta plana

REF.01340



» Point de test
 » Ponto de teste

REF.02626



8 cm



9 cm



» Pointe plate
 » Ponta plana

REF.01341



» Point de test
 » Ponto de teste

REF.02627



8 cm



9 cm



» Pointe plate
 » Ponta plana

REF.02793



» Pointe plate
 » Ponta plana

REF.02794



9 cm



9 cm



» Pointe plate
 » Ponta plana

REF.02795



» Pointe oblique
 » Ponto oblíquo

REF.02628



9 cm



9 cm



» Pointe plate
 » Ponta plana

REF.02796



9 cm

Pincès à épiler POLLIÉ
Pinças de depilar POLLIÉ

12
u.m.vta

12
box



» Point de test
 » Ponto de teste

REF.03206

REF.03205



Pincès à épiler anatomique
Pinças de depilar anatômica

12
u.m.vta

12
box



» Point fine
 » Ponta fina



Inox

REF.02631



» Pointe plate
 » Ponta plana



Inox

REF.02629



» Pointe oblique
 » Pointe oblique

REF.02540/50



» Pointe oblique
 » Pointe oblique

Inox

REF.02630



» Pointe oblique
 » Pointe oblique

REF.02742/50



» Pointe oblique
 » Pointe oblique

Inox

REF.02500



Pince à épiler couleurs assorties
Pinças depilar, diferentes cores

12 u.m.vta 12 box



» Pointe oblique
 » Pointe oblique



REF.02123



» Pointe oblique
 » Pointe oblique

Inox

REF.02499



» Pointe oblique
 » Pointe oblique



REF.02744



6,5 cm

REF.02744/50



» Pointe oblique
 » Pointe oblique

REF.02743



» Pointe oblique
 » Pointe oblique

REF.02742



8 cm

REF.02743/50



9,5 cm

REF.02742/50

Présentoir de 24 Pincas à épiler couleurs assorties
Expositor 24 pinças diferentes cores

1
u.m.vta

20
box

REF.03723



» Pointe oblique
 » Pointe oblique



Présentoir de 24 Pincas à épiler motif animal
Expositor 24 pinças estampado animal

1
u.m.vta

20
box

REF.03724



» Pointe oblique
 » Pointe oblique



Présentoir de 24 Pincas à épiler noires
Expositor 24 pinças cor pretas

1
u.m.vta

20
box

REF.03725



» Pointe oblique
 » Pointe oblique



Manucure et pédicure

MANICURE
E PEDICURE

*Vernis à ongles, dissolvant, lampes
à manucure, ponceuses à ongles,
loupes, limes, pinces...*

*Verniz, removedores, lâmpadas de
manicure, tornos de unhas, lupas,
limas, alicates...*



Comment VERNIR? · Cómo aplicar?

1. Appliquez une base pour protéger les ongles
2. Avant d'appliquer le vernis coloré, il est nécessaire de secouer le contenu un peu, mais vous ne devez en aucun cas le secouer de haut en bas, car le vernis laissera des bulles sur les ongles. L'idéal est de placer la bouteille entre vos mains et de la faire rouler horizontalement. Lorsque vous appliquez le vernis sur les ongles, il est important de le faire à partir du milieu et de l'étendre verticalement.
3. L'application sera faite avec une petite quantité de vernis sur dans le pinceau et en partant de la cuticule jusqu'à la pointe de l'ongle. De bas en haut
4. Pour une plus grande durabilité, appliquez la couche de finition désirée en scellant l'embout.
5. Pour finir, appliquez de l'huile pour les cuticules et la crème pour les mains

1. Aplique uma base para proteger a unha
2. Antes de aplicar o verniz, é necessário mover o conteúdo um pouco, mas não deve agitá-lo de cima para baixo, porque a tinta deixará bolhas nas unhas. O ideal é colocar nas mãos e enrolar horizontalmente. Ao aplicar a verniz para as unhas, é importante fazê-lo a partir do meio e estendê-lo verticalmente.
3. A aplicação será feita com uma pequena quantidade de na escova e a partir da cutícula até a ponta da unha. De baixo para cima.
4. Para maior durabilidade, aplique a camada superior desejada vedando a ponta.
5. Finalmente, aplique óleo de cutícula e creme para as mãos

Présentoir vernis à ongles POLLIE
Expositor vernizes unhas POLLIE

- » 3 vernis à ongles x 33 couleurs
- = 99 vernis à ongles au total
- » 1 nuancier
- » Présentoir: base + cartouche
- » 1 Poster

- » 3 vernizes x 33 cores = 99 vernizes no total
- » 1 carta de cores Expositor: base
- » +carta de cores
- » 1 Póster



REF.03609

Vernis à ongles POLLIE
Vernizes unhas POLLIE

12 ml

REF.03505

Blanc solide
Blanco sólido

REF.03507

Blanc
Blanco

REF.03503

Blanc perle
Blanco Perla

REF.03501

Glace
Hielo

Vernis à ongles POLLIE
Vernizes unhas POLLIE3
u.m.vta3
box

12 ml

REF.03497

Beige
Beige

REF.03513

Sable
Areia

REF.07426



NEW

Rose nude
Rosa nu

REF.07424



NEW

Super Nude
Sueper Nu

REF.03422

Chameau
Camel

REF.03495

Manucure
française
Manicure
francesaRose pastel
Rosa pastel

REF.03494

Rose pastel
Rosa pastel

REF.04477

Rose Candy
Rosa Candy

REF.03496

Rose
chewing-gum
Rosa chicla

REF.03504

Rose fuchsia
Rosa fúcsia

REF.04479

Amarante
Amaranto

REF.03423

Terracota
Terracote

REF.06239

Betterave
Beterraba

REF.03510

Coral
Coral

REF.03511

Fraise
Morango

REF.03502

Rouge passion
Vermelho
paixão

REF.07423



NEW

Cerise
Cereja

Vernis à ongles POLLIE
Vernizes unhas POLLIE

12 ml



REF.03490

Rouge cerise
Cereja

REF.04295

Rouge métallisé
Vermelho metalizado

REF.03493

Grenat
Granada

REF.03491

Chocolat
Chocolate

REF.03859

Jaune
Amarelo

REF.04085

Doré
Dourado

REF.03499

Bronze
Bronze

REF.04292

Cuivre
métallisé
*Cobre
metalizado*

REF.04227

Turquoise pastel
Turquesa pastel

REF.03860

Vert émeraude
Verde esmeralda

REF.04569

Vert de la
mer
Verde mar

REF.04478

Vert aigue-
marine
*Verde água
marinha*

REF.04294

Vert jade
Verde Jade

REF.03509

Turquoise
Turquesa

REF.04570

Vert de genévrier
Verde zimbro

REF.03420

Vert forêt
Verde bosque

Vernis à ongles POLLIE
Vernizes unhas POLLIE3
u.m.vta3
box

12 ml



REF.06240

Vert forêt
Selva verde

REF.03861

Bleu cyan
Azul cyan

REF.04293

Bleu métalisé
Azul metalizado

REF.03508

Bleu métallique
Azul metalizado

REF.04567

Bleu
électrique
Azul añil

REF.03506

Lilas perlé
Lilás pérolado

REF.04226

Lila pastel
Lilás pastel

REF.04568

Améthyste
Ametista

REF.07425

Lilas intense
Lilás intenso

NEW



REF.03421

Violet
Violeta

REF.04082

Aubergine
Beringela

REF.04291

Argent
Prata

REF.03512

Gris mate
Cinza fosco

REF.03492

Noir
Preto

REF.04084

Paillette
argentée
Purpurina
prata

REF.04086

Couleurs
assorties
Purpurina cores

Vernis à ongles POLLIE
Vernizes unhas POLLIE3
u.m.vta 3
box

12 ml



REF.03913

Top Coat "mat" séchant
Top Coat "mate" secante

REF.04261

Top Coat effet "gel"
Top coat efeito "gel"

REF.03518

Brillant asséchant
(type de couche)
Brilho secante (tipo coat)

REF.03514

Base de
vitamine
Base
vitaminada

REF.03515

Anti stries
Anti-estrias

REF.03516

Durcisseur
Endurecedor

REF.03517

Gel elimine
cuticules
Remove-
cutícula gel**Nuanciers vernis à ongles POLLIE**
POLLIE carta cores vernizes de unhas1
u.m.vta 150
box

12 ml

REF.06580

» Comprend 4 roues de couleurs
» Inclui 4 rodas com cores**Spray séchant pour ongles**
Spray secante de unhas1
u.m.vta 12
box

200 ml

REF.06693

Il accélère le séchage
du vernis, rehausse
sa brillance et évite
sa détérioration.
Vaporiser sur les ongles
fraîchement peints,
en écartant les doigts,
à une distance de 15
centimètres.Acelera a secagem do
verniz, realça o seu brilho
e evita a deterioração do
verniz. Vaporizar sobre
as unhas recém pintadas,
separando os dedos e a
uma distância de cerca de
15 centímetros.

Kit vernis à ongles "back to basics"
Kit vernizes unhas "back to basics"

1
u.m.vta

6
box

4 x 12 ml

REF.07154



Kit de vernis à ongles Manucure française
Kit vernizes de unhas Manicure francesa

1
u.m.vta

6
box

4 x 12 ml

REF.03863





PAS À PAS P-LACK · PASSO A PASSO P-LACK

1. Appliquez une fine couche de base de P-Lack, sans toucher les cuticules ni le contour de l'ongle. Scellez bien le bord du clou avec la même base. Effectuez cette opération de la première main et séchez / polymérisez avec une lampe UV pendant 120 secondes ou avec une lampe à LED pendant 90 secondes. Répétez avec l'autre main.
2. Appliquez ensuite une fine couche de couleur P-Lack, en évitant les cuticules et le contour de l'ongle. Scellez bien le bord de l'ongle avec la même couleur. Effectuez cette opération de la première main, séchez et polymérisez avec une lampe UV pendant 120 secondes ou avec une lampe LED pendant 90 secondes. Répétez cette opération avec l'autre main.
3. Appliquez une seconde couche mince de P-Lack Color en suivant les mêmes indications que dans la première couche.
Très important pour bien sceller le bord du clou.
4. Pour une plus longue durée avec une finition parfaite et brillante, nous appliquerons une fine couche de P-Lack Gloss en suivant les mêmes indications que dans les cas précédents.
5. Pour terminer: enlevez les résidus collants et dégraisser les ongles en humidifiant une lingette en cellulose avec Nail Cleaner, nettoyant ongle. Finition brillante et sans parties opaques.
6. Appliquez de l'huile sur les cuticules et l'hydratant

1. Aplique uma capa fina de base P-Lack, sem tocar nas cutículas ou no contorno da unha. Selar bem a borda da unha com a mesma base. Realize esta operação na primeira mão e seque com uma lâmpada UV por 120 segundos ou com uma lâmpada LED por 90 segundos. Repita com a outra mão.
2. Em seguida, aplique uma capa fina de cor P-Lack, sem tocar nas cutículas ou no contorno da unha. Selar bem a borda da unha com a mesma cor. Realize esta operação na primeira mão e seque com uma lâmpada UV por 120 segundos ou com uma lâmpada LED por 90 segundos. Repita esta mesma operação com a outra mão.
3. Aplique uma segunda capa fina de P-Lack Color seguindo as mesmas indicações da primeira capa. Muito importante para selar bem a borda da unha.
4. Para uma duração mais longa com um acabamento perfeito e brilhante, aplicaremos uma fina camada de P-Lack Gloss seguindo as mesmas indicações dos casos anteriores.
5. Para finalizar: remova os resíduos pegajosos e desengraxe as unhas, umedecendo um lenço de celulose com o Limpador de Unhas, limpando a unha. Final de acabamento brilhante e sem partes opacas.
6. Aplique óleo nas cutículas e hidratante

Nuancier couleurs P-LACK Carta cores P-LACK

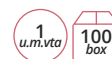

REF.06558



Vernis à ongles semi-permanent P-LACK
Vernizes semipermanente P-LACK



9 gr

REF.06247



Dark Sky

REF.06246



Flames



REF.06245



Dark Rouge

REF.06248



Summer Fire

REF.06249



Violet Arrow

REF.06250



Pink Candy

REF.06251



Barbies dress

REF.06253



Pink Ribbon

REF.06254

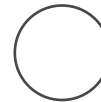

Pure White

REF.06255



Green Paradise

REF.06256



Clear Pink

REF.06257



Clear White

REF.06258



Chestnut

REF.06262



Baby Doll

Vernis à ongles semi-permanent P-LACK
Vernizes semipermanente P-LACK

9 gr



Nail primer POLLIÉ

Pollié nail primer

ACRYLIQUE GEL
GEL ACRILICO



Vernis à ongles pour assurer une adhérence parfaite du gel et de l'acrylique. Contient des acides.

MODE D'EMPLOI :

1. Préparer les ongles.
2. Primer : appliquer une fine couche et laisser sécher à l'air.
3. Appliquer le gel de construction ou acrylique, et poursuivre la procédure.

Para assegurar a perfeita aderência do gel e do acrílico. Contém ácidos.

COMO UTILIZAR:

- » 1. Preparar as unhas.
- » 2. Primeiro: aplicar uma capa fina e deixar secar ao ar.
- » 3. Aplicar o gel de construção ou acrílico e continuar com o processo.



7 ml

REF.06673



7 ml

REF.07116

Acid free

Préparation des ongles P-LACK

Preparação de unhas P-LACK



15 ml

REF.07421

NEW



Vernis à ongles base/top

Nail polish base/topcoat



9 gr

REF.06674

Produit 2 en 1 transparent : base + top pour gel acrylique. Il doit être appliqué comme base avant le gel acrylique et après comme top pour terminer.

Produto 2 em 1 transparente: base e top para o acrylic gel. Aplica-se como base antes do gel acrílico e depois como top para finalizar.



Acrylique gel

Gel acrílico

1
u.m.vta

12
box



Le gel acrylique est la combinaison parfaite entre la technique de l'acrylique et du gel.

MODO DE USO:

» Le meilleur de l'acrylique: force, durabilité et dureté maximale avec une sculpture parfaite

» Le meilleur du gel: souplesse, sans odeur, sans monomère, propre et facile à remplir. Disponible en 5 couleurs

O Gel Acrílico é a combinação perfeita entre a técnica de acrílico e gel.

COMO UTILIZAR:

» O melhor do acrílico: resistência, durabilidade e dureza máxima com a melhor escultura

» O melhor do gel: flexibilidade, sem odor, sem monômeros, limpo e fácil de encher. Disponível em 5 cores

» Rose transparent
» Rosa transparente

60 gr

REF.06597



» Blanc
» Branco

60 gr

REF.06598



» Claire
» Claro

60 gr

REF.06599



» Camouflage
» Camuflagem

60 gr

REF.06600



» Rose intense
» Rosa intenso

60 gr

REF.06601



Préparation des ongles P-LACK Preparação de unhas P-LACK

NEW



1 L

REF.07422



Dissolvant P-LACK Remover P-LACK

- » Acétone pure
- » Parfum orange
- » Acetona pura
- » Perfume de laranja



1 L

REF.06263



Nettoyeur à ongles Limpador unhas



1 L

REF.06283



Dissolvant huileux rose Remover de verniz cor-de-rosa oleoso

Dissolvant d'émail à l'acétone enrichi en huile de ricin. Enlève le vernis à ongles en douceur en les laissant brillants et parfumés

Remover de verniz com acetona enriquecida com óleo de ricino. Remove verniz delicadamente deixando brilhantes e perfumadas as unhas.

- » Avec de l'acétone
- » Com acetona



150 ml

REF.06608



1 L

REF.06607



500 ml

REF.07172



1 L

REF.07173

Dissolvant de vernis à ongles Remover de verniz

À l'huile de ricin qui hydrate les cuticules
Com óleo de ricino que hidrata as cutículas

- » Sans de l'acétone, avec doseur
- » Sem acetona, com doseador

Dissolvant P-LACK Removedor P-LACK

NEW

 1
u.m.vta  19
box

150 ml

REF.07109



NEW

 1
u.m.vta  12
box



1 L

REF.07110



Nettoyeur à ongles (nettoyant / dégraissant) Limpador unhas (limpador / desengordurante)

NEW

 1
u.m.vta  19
box

150 ml

REF.07111



NEW

 1
u.m.vta  24
box

400 ml

REF.07112



Dissolvant de vernis express Removedor de verniz express

1 u.m.vta
150 box

40 ml

- » Avec éponge et acétone
- » Com esponja e acetona

REF.04262



Pot de 10 trempes doigts individuels Conjunto 10 mergulha dedos individuais

1 u.m.vta
12 box

- » Ne pas utiliser avec un dissolvant de vernis à ongles sans acétone

- » Não use com removedor de esmalte sem acetona

REF.03879



Feuilles enveloppées pour enlever 100 unités Folhas envolvidas para remover 100 unidades

1 u.m.vta
107 box

Feuilles de papier d'aluminium avec coton incorporé pour être facile et pratique à appliquer avec le dissolvant ou l'acétone sur l'ongle.

Folhas de papel alumínio com algodão incorporado para serem fáceis e convenientes de aplicar com o removedor ou acetona na unha.



100 u

REF.04824

Crème mains ultra-hydratante et nutritive Creme para as mãos ultra hidratante e nutritivo

Une crème ultra-hydratante et nutritive sans sensation grasse, qui enveloppe les mains d'un voile réparateur doux et puissant. **L'Huile de Rose Musquée** est un régénérateur extrêmement puissant pour notre peau.

- Elle agit à la surface de la peau comme facteur humidifiant naturel et améliore l'hydratation.
- Elle nourrit et régénère.
- Elle réduit la perte en eau de notre épiderme en renforçant et en multipliant la barrière de céramides.
- Elle corrige et prévient les problèmes cutanés liés au photo-âge, grâce à l'auto-génération de mélanine.
- Elle revitalise le fibroblaste, qui est la cellule dermique protectrice du collagène, acide hyaluronique, élastine et responsable de la fermeté et de l'élasticité de notre peau.

Um creme ultra hidratante e nutritivo sem sensação de oleosidade que envolve as mãos num suave e poderoso véu reparador. O **Óleo de Rosa Mosqueta** é um poderosíssimo regenerador para a nossa pele.

- » Atua de forma superficial como fator natural humectante, melhorando a hidratação.
- » Nutre e regenera.
- » Reduz a perda de água na nossa epiderme, já que reforça e multiplica a barreira de ceramidas.
- » Corrige e previne os problemas cutâneos causados pelo fotoenvelhecimento, através da autogeração de melanina.
- » Revigoriza o fibroblasto, que é a célula dérmica produtora do colagénio, ácido hialurónico, elastina e responsável pela firmeza e elasticidade da nossa pele.

- » Avec doseur
- » Com doseador

1 u.m.vta
12 box

500 ml

REF.07083

1 u.m.vta
12 box

100 ml

REF.07082



Pinceau éventail avec poils synthétiques**Pincéis ventilador de cabelo sintético**

» Grand
» Grande

NEW



REF.07097

NEW



REF.07098

Pinceaux à ongles acryliques kolinsky**Pincéis unhas acrílicas kolinsky**

Pinceaux à ongles en acrylique avec des poils. Connus pour leur résistance et sa durée, et aussi par leur grande élasticité et leur absorption maximale du produit

Considerado o melhor pêlo para pincéis de unhas acrílicas pela sua resistência e duração, pela sua grande elasticidade e máxima absorção do produto



N° 2

REF.03659



N° 4

REF.03660



N° 6

REF.03661



N° 8

REF.03662

Pinceaux à ongles gel**Pincéis unhas gel**

» Poils en nylon
» Cerdas de nylon



N° 2

REF.03654



N° 4

REF.03655



N° 6

REF.03656



N° 8

REF.03657



N° 10

REF.03658

Les ongles en gel ne sont pas fabriqués avec le même pinceau utilisé pour les ongles en acrylique. N'oubliez pas que plus le numéro de votre pinceau est grand, plus son épaisseur est grande. Si vous souhaitez sculpter des ongles en gel, vous devez utiliser des brosses spéciaux qui facilitent la mise en place du gel. Pour cette raison, des pinceaux très différents sont utilisés.

Actuellement, les pinceaux utilisés pour appliquer le gel sont en nylon (synthétique). CHEVEUX SYNTHETIQUES, VIOLA ALUMINIUM, MANCHE EN BOIS

Lembre-se, quanto maior o número do seu pincel, maior a espessura. Se quiser esculpir as unhas em gel, deve usar pincéis especiais que facilitam a colocação do gel. Isso ocorre porque o gel é diferente do acrílico. Por esse motivo, são usadas escovas muito diferentes.

Atualmente os pincéis usados para aplicar gel são de nylon (sintéticas). CERDAS SINTÉTICAS, VIOLA ALUMÍNIO, PUNHO DE MADEIRA

Set de 6 pincesaux décoration ongles
Set 6 pincéis decoração unhas

1
u.m.vta

12
box

- » Cheveux synthétiques
- » Cerdas sintéticas



REF.03653

Pinceau gel + repousse-cuticules
Pincel gel + empurrador de cutículas

1
u.m.vta

12
box

REF.06760

Nail art



Stylo dotting pour ongles
Pincel dotting para unhas

1
u.m.vta

12
box

Nail art

REF.06761



Stylo gradient pour ongles
Pincel gradient para unhas

1
u.m.vta

12
box

Nail art

REF.06762

- » 4 Têtes de rechange
- » 4 Pontas



Support de pincesaux noir
Supporte cor preto de pincéis

1
u.m.vta

12
box

REF.04822



Set NAIL ART
Conjunto NAIL ART

1
u.m.vta

42
box

- » 15 Pinceaux à ongles
- » 5 Stylos à double tête en métal
- » 15 Pincéis para unhas
- » 5 De dupla ponta de metal

REF.06759



Manucures originales Manicures originais



Avec les poinçons, vous pouvez décorer les ongles et faire un nombre infini de formes, de lignes, de points, de fleurs, le tout dans des couleurs différentes. Les pinceaux à pointe fine vous aideront à faire ces petits détails qui feront de vos ongles une petite œuvre d'art.

Pode decorar as unhas e fazer um número infinito de formas, linhas, pontos, flores, tudo em cores diferentes. Com uma ponta fina vai ajudar a fazer esses pequenos detalhes que farão das suas unhas uma pequena obra de arte.

Set de 5 poinçons de décoration d'ongles Decoração unhas



REF.04093

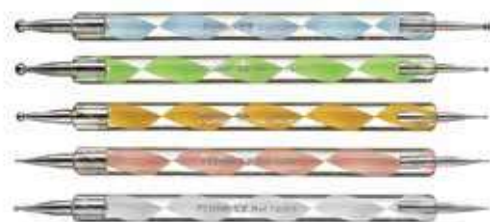

Roue strass rhinestone nail art Strass rhinestone nail art



600 u

REF.06774

Roue fimo nail art fleurs et fruits Fimo nail art flores e frutas



144 u

REF.04835

Roue strass rhinestone de couleurs nail art
Strass rhinestone cores nail art» Mini
» Mini**NEW**

600 u

REF.07347

NEW

600 u

REF.07345

Roue strass rhinestone argent nail art
Strass rhinestone prata nail art**NEW**

144 u

REF.07346

NEW

144 u

REF.07342

Roue nail art sequins strass
Sequins rhinestones nail art wheel**NEW**

144 u

REF.07343

NEW

REF.07352

Carrousel Peace & Love
Carrossel de paz e amor

Autocollants 3d Adesivos 3d



- » Cœurs blancs
- » Corações

REF. 04831

- » Papillons blancs
- » Borboletas brancas

REF. 04832



- » Fleurs blanches
- » Flores brancas

REF. 04833

- » Fleurs de couleurs
- » Flores de cores

REF. 04834



Feuille pour ongles 1,5 mm Folha de decoração para unhas 1,5 mm



- » Noir
- » Cor preto

REF. 06770

- » Dorée
- » Dourada

REF. 06768

- » Argentée
- » Prateada

REF. 06769



Bande adhésive pour ongles 0,8 mm
fita adesiva para unhas 0,8 mm

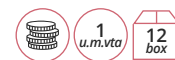

» Noir
 » Preta

REF.06773

» Dorée
 » Dourada

REF.06771

» Argentée
 » Prateada

REF.06772



Décoration nail art
Decoração arte



» Fleurs sèches
 » 12 couleurs

REF.06763

» Glitter variés
 » 16 g x 12 couleurs

REF.06764

» Flores secas 12 cores

» Glitter sortidos
 » 16 g x 12 cores



» Poudres assortiments
 velours
 » 0,5 g x 12 couleurs

REF.06765

» Glitter écailles sirène
 » 1 g x 12 couleur

REF.06766

» Feuille d'or
 » 12 Couleurs

REF.06767

» Pós sortidos de veludo

» 0,5 g x 12 cores

» Glitter escama sereia
 » 1 g x 12 cores

» Folhas de ouro
 » 12 cores cores



Décoration nail art**Decoração arte**

» Boules Nail Art Caviar Micro Cristal
» 1,5g x 12

REF.07344

» Glitter powder glitter nail art
» 1,5 g x 12 couleurs

REF.07348

» Bolas de Nail Art Microcristal de caviar
» 1,5g x 12

» Glitter powder glitter nail art
» 1,5 g x 12 cores

NEW**NEW**

» Poudres de sable pour nail art
» 1,5 g x 12 couleurs

REF.07349

» Glitter nail art assorti
» 1,5 g x 12 couleurs

REF.07350

» Pó de areia para Nail Art
» 1,5g x 12 cores

» Diversos purpurina Nail Art
» 1,5g x 12 cores

NEW**NEW**

» Losanges en paillettes
» 1,5 x 12 g

REF.07351

» Palette nail art nacré
» Paleta de Nail Art Perolada

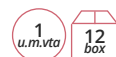
NEW

» Losangos em flocos brilhantes
» 1,5 x 12 g

144 u

REF.07382

Moule à ongles
Molde para unhas» Rectangulaire
» Retangular

500 u

REF.04825

» Fer à cheval moyens
» Médios

500 u

REF.04826

» Double épaisseur
» Dupla espessura

500 u

REF.04827

**Distributeur transparent pour moules à ongles**
Dispensador transparente para moldes de unhas

REF.04828

**Moules pour ongles réutilisables**
Moldes para unhas reutilizáveis

5 u

REF.06750

**Bandes de guidage pour french manicure**
Guias para french manicure

REF.04829

» Formes
» Formas

REF.04830

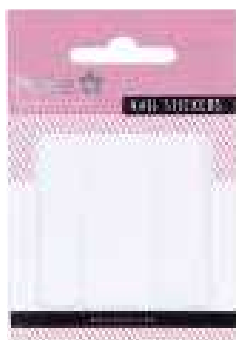

Tips pour ongles Tips para unhas



1
u.m.vta

46
box

» Naturels
square

» *Naturais square*



100 u

REF.06743

» Naturels
courbés

» *Naturais curvados*



100 u

REF.06744

» Blancs
square

» *Branços square*



100 u

REF.06745

» Blancs
courbés

» *Branços curvados*



100 u

REF.06746

» Transparents
square

» *Transparentes square*



100 u

REF.06747

» Transparents
courbés

» *Transparentes curvados*



100 u

REF.06748

Sachet de 10 palettes pour démo Pacote de 10 paletes para demo



1
u.m.vta

15
box

» Naturelle
» *Natural*

REF.06751

» Transparente
» *Transparente*

REF.06752



Main articulée pour entraînement de manucure

Mão articulada para práticas de manicure



REF.07080

Rechange

Peças de reposição

» Sachet de 100 ongles
» Pacote de 100 unhas



REF.07081



Main malléable pour manucure

Mão práticas manicure



REF.04356

» Avec support
» Com suporte



REF.04353



Cellulose prédécoupée

Celulose pré-cortada

Sachet de 2 rouleaux de cellulose. 500 carrés 4 x 5 cm. Super absorbants. Idéal pour enlever le vernis. Ne peluche pas. Ø 15 · Poids: 155 gr. Tolérance 15 gr.

Saco com 2 rolos de celulose pré-cortada em pedaços de 4 x 5 cm. Cada rolo é de 500 unidades, de pensos absorventes. Ideal para remove. Ø 15 · Peso: 155 gr. Tolerância 15 gr.

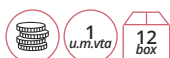

REF. 03060

» Anonyme
» Anônimo



03060/00



(2 x 500ud)



(2 x 500ud)

Distributeur+ 1000 pad nail
Dispensador + 1000 pad

1 u.m.vta
12 box

Carrés prédécoupés. Ne peluche pas. Idéal pour enlever le vernis avec du dissolvant ou la couche de graisse du vernis semipermanent.

Quadrados pré-cortados confortáveis de usar. Ideal para remover com acetona ou semi-permanente.



REF.06471

Bande de protection
Tips para unhas

1 u.m.vta
12 box

- » Rose
- » Rosa

REF.06757



Godet forme tube
Godé forma tubo

1 u.m.vta
12 box

- » En plastique
- » De plástico

REF.06758



Récipient pour manucure
Copinho para manicure

1 u.m.vta
12 box

- » En verre
- » De cristal

REF.06756



Récipient blanc avec bouchon en liège
Recipiente cerâmico com tampa de cortiça

1 u.m.vta
106 box

- » Blanc
- » Branco

REF.06775



Clips soak off remover 10 u
Clipes soak off remover 10 un

1 u.m.vta
106 box

- » Blancs
- » Brancos

REF.06777

- » Rose
- » Rosas

REF.06778



Lampe uv-led pour ongles Catalisador de unhas uv-led



REF. 07186



NEW

- » Puissance: 65 W
- » Poids: 450gr
- » Ampoule à LED UV: 33 unités
- » Longueur d'onde des leds : 395-405nm
- » Tension: 100-240V ~
- » Fréquence : 50/60 Hz
- » Minuterie: 10", 30", 60" et 99 "
- » Adaptateur de sortie: DC 24 V = 2A
- » Température de fonctionnement: -10°C à -35 ° C
- » Support métallique amovible aimanté.

- » Potência: 65W
- » Peso: 450 gr
- » Lâmpadas Led/UV: 33 unidades
- » Comprimento de onda Leds: 395-405nm
- » Voltagem: 100-240V
- » Frequência 50/60 Hz
- » Temporizador: 10", 30", 60" e 99" segundos
- » Saída do Adaptador: DC 24V = 2A
- » Temperatura de trabalho: -10°C a -35°C.
- » Base metálica removível magnetizada.



Lampe Uv Led · Catalisador de unhas UV Led

Nous présentons nos lampes UV LED 48W (Ref.06638, modèles MOON LIGHT et 06639, SUN LIGHT), elles sont le complément idéal pour le séchage rapide et sûr des vernis à ongles semi-permanents et des gels de reconstruction manucure / pédicure, spécialement formulé pour le séchage des LED.

Apresentamos as nossas lâmpadas LED UV de 48W (Ref.06638 modelo MOON LIGHT e 06639 modelo SUN LIGHT), são o complemento ideal para a secagem rápida e segura da verniz de unhas semi-permanentes e géis de reconstrução de manicura / pedicura, bem como Especialmente formulado para secagem por LED.

Lampe uv-led pour ongles Catalisador de unhas uv-led



REF. 06638



- » Puissance: 48W
- » Poids: 450gr
- » Ampoule à LED UV: 21 unités
- » Longueur d'onde des leds : 395-405nm
- » Tension: 100-240V ~
- » Fréquence : 50/60 Hz
- » Minuterie: 30", 60" et 99"
- » Adaptateur de sortie: DC 24V / 1,5 A
- » Température de fonctionnement: -10 °C à -35 ° C

- » Potência: 48W
- » Peso: 450 gr
- » Lâmpadas Led/UV: 21 unidades
- » Comprimento de onda Leds: 395-405nm
- » Voltagem: 100-240V
- » Frequência 50/60 Hz
- » Temporizador: 30", 60" e 99" segundos
- » Saída do Adaptador: DC 24V/1.5 A
- » Temperatura de trabalho: -10°C a -35°C.



Lampe uv-led pour ongles Catalisador de unhas uv-led



REF. 06639



- » Puissance: 48W
- » Poids: 560 gr
- » Ampoule à LED UV: 24 unités
- » longueur d'onde des Leds : 395-405nm
- » Tension: 100-240 V ~
- » Fréquence 50/60 Hz
- » Minuterie: 10", 30", 60" et 99" secondes
- » Adaptateur de sortie: DC 24V / 1.5A
- » Température de fonctionnement: 0°C à 40°C
- » Base détachable

- » Potência: 48W
- » Peso: 560 gr
- » Lâmpadas Led/UV: 24 unidades
- » Comprimento de onda Leds: 395-405nm
- » Voltagem: 100-240V
- » Frequência 50/60 Hz
- » Temporizador: 10", 30", 60" e 99" segundos
- » Saída do Adaptador: DC 24V/1.5 A
- » Temperatura de trabalho: -10°C a -35°C.
- » Base destacável



Nous présentons nos lampes UV à LED 48W (Ref.06640, modèles POWER LIGHT et 06641, FAST LIGHT), elles sont le complément idéal pour le séchage rapide et sûr des vernis à ongles semi-permanents et des gels de reconstruction manucure / pédicure, ainsi que spécialement formulé pour le séchage des LED.

Apresentamos nossas lâmpadas LED UV de 48W (Ref.06640 modelo POWER LIGHT e 06641 modelo FAST LIGHT), são o complemento ideal para secagem rápida e segura da varniz de unhas semi-permanentes e géis de reconstrução de manicure / pedicure, bem como Especialmente formulado para secagem por LED.

Lampe UV-led pour ongles modèle: POWER LIGHT Catalisador de unhas IV-led modelo: POWER LIGHT



REF. 06640



- » Puissance: 48W
- » Poids: 880 gr
- » Ampoule à LED UV: 36 unités
- » longueur d'onde des Leds : 395-405nm
- » Tension: 100-240 V ~
- » Fréquence 50/60 Hz
- » Minuterie: 30", 60 "et 99" secondes
- » Adaptateur de sortie: DC 24V / 1.5A
- » Température de fonctionnement: -10°C à -35°C
- » Base amovible
- » Pour manucure et pédicure

- » Potência: 48W
- » Peso: 880 gr
- » Lâmpadas Led/UV: 36 unidades
- » Comprimento de onda Leds: 395-405nm
- » Voltagem: 100-240V
- » Frequência 50/60 Hz
- » Temporizador: 30", 60" e 99"segundos
- » Saída do Adaptador: DC 24V / 1.5A
- » Temperatura de trabalho: -10°C a -35°C
- » Base desmontável
- » Para manicure e pedicure.



Lampe UV-led pour ongles modèle: FAST LIGHT Catalisador de unhas UV-led modelo: FAST LIGHT



REF. 06641



- » Puissance: 48W
- » Poids: 740 gr
- » Ampoule à LED UV: 36 unités
- » longueur d'onde des Leds : 395-405nm
- » Tension: 100-240 V ~
- » Fréquence 50/60 Hz
- » Minuterie: 10°,30", 60 "et 99" secondes
- » Adaptateur de sortie: DC 24V / 1.5A
- » Température de fonctionnement: -10°C à -35°C
- » Base amovible

- » Potência: 48W
- » Peso: 740 gr
- » Lâmpadas Led/UV: 36 unidades
- » Comprimento de onda Leds: 395-405nm
- » Voltagem: 100-240V
- » Frequência 50/60 Hz
- » Temporizador: 10°,30", 60" e 99"segundos
- » Saída do Adaptador: DC 24V / 1.5A
- » Temperatura de trabalho: -10°C a -35°C
- » Base desmontável



Lampe Uv Led · Catalisador de unhas UV Led

Nous présentons nos lampes led 24w (réf.04919 star light model) et 48w (réf. 04920 energy light model), elles sont le complément idéal pour le séchage des vernis à ongles semi-permanents et des gels de reconstruction manucure / pédicure, ainsi comme ceux formulés spécialement pour le séchage à LED.

Apresentamos as nossas lâmpadas led de 24W (ref.04919 star light model) e 48w (ref.04920 energy light model), que são o complemento ideal para a secagem da verniz de unhas semi-permanentes e géis de reconstrução de manicura / pedicura, bem como aqueles formulados especialmente para secagem por LED.

Lampe led UV 24W STAR LIGHT

Catalisador led UV 24W STAR LIGHT



REF. 04919



- » Puissance: 24W
- » Led/UV: 15 unités
- » Longueur d'onde des Leds : 395-405nm
- » Tension: 100-240V~
- » Fréquence 50/60 Hz
- » Minuterie: 10", 30", 60" y 99"secondes
- » Base amovible pour manucure et pédicure

- » Potência: 24W
- » Led / UV: 15 unidades
- » Comprimento de onda Leds: 395-405nm
- » Voltagem: 100-240V ~
- » Frequência 50/60 Hz
- » Temporizador: 10", 30", 60" and 99" segundos
- » Base desmontável para manicure e pedicure.



Lampe led UV 48W ENERGY LIGHT

Catalisador led UV 48W ENERGY LIGHT



REF. 04920



- » Puissance: 48W
- » Led/UV: 24 unités
- » Longueur d'onde des Leds : 395-405nm
- » Tension: 100-240V~
- » Fréquence 50/60 Hz
- » Minuterie: 10", 30", 60" y 99" secondes
- » Base amovible pour manucure et pédicure

- » Potência: 48W
- » Led / UV: 24 unidades
- » Comprimento de onda Leds: 395-405nm
- » Voltagem: 100-240V ~
- » Frequência 50/60 Hz
- » Temporizador: 10", 30", 60" and 99" segundos
- » Base desmontável para manicure e pedicure.



Lampe uv 9w avec minuterie
Catalisador de unhas uv 9w com temporizador

REF. 03150

Lampe UV Pollié de taille réduite idéale pour vos manucures ou pédicures de ongles en gel, vernis gel permanent, vernis semi-permanent ou toute autre technique nécessitant un séchage avec lampe. En raison de sa petite taille et de son faible poids, il est aisé de transporter

- » Puissance: 36W
- » Minuterie: 90 secondes, 120 secondes et 30 minutes
- » 4 ampoules UV (4x9W) 36W
- » Plateau amovible

Catalisador UV Pollié de tamanho reduzido ideal para as manicures ou pedicures de unhas de gel, esmalte permanente em gel, esmalte semipermanente ou qualquer outra técnica que precise secagem com catalisador. Graças ao seu tamanho reduzido e ao facto de ser leve é perfeita para transportar, para casa ou para qualquer lado.

- » Potência: 24W
- » Temporizador: 90 "segundos, 120" segundos e 30 'minutos
- » 4 lâmpadas UV (4x9W) 36W

**Ampoule de rechange · Lâmpada de substituição**

- » 9W UV
- » 9W UV



REF. RE03150/01

- » 9W UV Led
- » 9W UV Led



REF. RE04354/02

Mini lampe led 2w portable usb
Mini catalisador de unhas led 2w portátil usb

REF. 04355

- » Puissance: 2W
- » Spéciale pour les ongles en gel, vernis semi-permanent
- » Lumière UV de 365 nm.
- » Minuterie 10 "
- » CABLE USB INCLUS
- » Idéale pour être emportée en voyage et pour être mise en poche grâce à sa petite taille

- » Potência: 2W
- » Especial para unhas de gel, verniz semipermanente...
- » Luz UV 365 nm.
- » Temporizador 10"
- » CABO USB INCLUÍDO
- » Ideal para levar de viagem e transportar graças ao seu tamanho de bolso.



Manucure spa Spa manicure

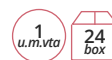

REF. 04265

- » Puissance: 2W
- » Batterie non incluse
- » Massage pré-manucure avec bulles stimulant qui adoucit les cuticules
- » Tension: 100-240V~
- » Fréquence 50/60 Hz

- » Potência: 2W
- » Bateria não incluída
- » Massagem estimulante de borbulhas pré-manicure que suaviza as cutículas
- » Voltagem: 100-240V ~
- » Frequência 50/60 Hz



Aspirateur ongles pour manucure Aspirador manicure



Aspirateur de table pour la poussière de manucure, design élégant et très fonctionnel, actuel et original. Aspire parfaitement la poussière la poussière est emmagasinée dans un sachet qui se trouve sous l'aspirateur purifie l'air.

- » Puissance: 2W
- » Batterie non incluse
- » Avec 3 sachets de rechange

Aspirador para utilizar sobre a mesa de manicure para aspirar o pó, elegante e muito funcional, design moderno e atual. Aspira eficazmente o pó produzido resultante da limagem, ou com a broca, o pó vai parar debaixo do aspirador, num saco adequado, evitando assim respirar restos de pó.

- » Potência: 2W
- » Bateria não incluída
- » Com 3 sacos de substituição



REF. 04205

Paraffine: hydrate et nourrit vos mains et vos pieds**Parafina: hidrata e nutre suas mãos e pés**

500 gr

- » Hydrate en profondeur
- » Améliore considérablement l'apparence de la peau
- » Élastifie la peau
- » Améliore la microcirculation sanguine
- » Il favorise l'absorption des actifs
- » Aide à éliminer les liquides et les toxines
- » Améliore les contractures et facilite le massage
- » Apaise la douleur et l'inflammation

- » Hidrata em profundidade
- » Melhora significativamente a aparência da pele
- » Elasticiza a pele
- » Melhora a microcirculação sanguínea
- » Favorece a absorção de ativos
- » Ajuda a eliminar líquidos e toxinas
- » Melhora as contraturas e facilita a massagem
- » Suaviza a dor e a inflamação

Monoï paraffine de Tahiti et menthe

Soin tonifiant réparateur de la peau des mains et des pieds. Le monoï de Tahiti équilibre le manteau hydrolipidique naturel de la peau. Cela le rend plus élastique et offre une grande capacité à retenir l'humidité. Grâce à l'huile de menthe, elle tonifie et rafraîchit la peau.

REF. 04671

Parafina Monoï do Tahiti e Mint

Tratamento tonificante restaurador da pele das mãos e pés. O Monoï de Tahiti equilibra o manto hidrolipídico natural da pele. Isso torna mais elástica e fornece uma grande capacidade de reter a umidade. Graças ao óleo de menta, tonifica e refresca a pele.

**Paraffine Orange et Pêche**

Traitement nourrissant-protecteur de la peau des mains et des pieds. Riche en caroténoïdes, il possède d'importantes propriétés antioxydantes. C'est un traitement idéal pour les peaux matures et déshydratées.

REF. 04672

Parafina Laranja e Pêssego

Tratamento nutricional da pele das mãos e pés. Rico em carotenóides, possui importantes propriedades antioxidantes. É um tratamento ideal para peles maduras e desidratadas.

**Manteiga De Karité De Parafina**

Tratamento antioxidante A manteiga de karité é um dos melhores hidratantes e emolientes por excelência. Proporciona bem-estar e proteção à pele.

REF. 04673

Manteiga De Karité De Parafina

Tratamento antioxidante A manteiga de karité é um dos melhores hidratantes e emolientes por excelência. Proporciona bem-estar e proteção à pele

**Chauffage numérique de paraffine et avec mémoire de température****Aquecedor de parafina digital e com memória de temperatura**

REF. 06335

- » Puissance: 200W
- » Poids: 2 Kg
- » Tension: 220-240 V ~
- » Fréquence 50/60 Hz
- » Température: 40°C - 70°C
- » Convient aux pieds et aux mains

- » Potência: 48W
- » Peso: 2Kg
- » Voltagem: 100-240V~
- » Frequência 50 Hz
- » Temperatura: 40°C a 70°C
- » Adequado para pés e mãos



Sachet contenant 2 gants protecteurs anti uv, anti taches**Pacote 2 luvas protetoras da pele anti-uv, antimanchas**

REF. 04686

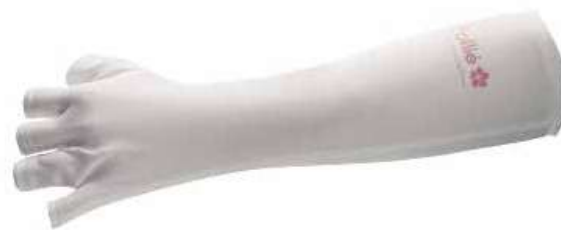
**Sachet 2 mitaines paraffine****Pacote 2 manfflas de corda paraffin**

REF. 06615



Mitaines pour le traitement de la paraffine. Sa doublure intérieure permet de maintenir la température pour un résultat de traitement optimal.

Luvas para o tratamento de parafina. Seu revestimento interno permite manter a temperatura para um resultado de tratamento ideal.

Sachet 2 chaussons paraffine**Pacote 2 peucos rizo parafina**

REF. 06616



Chaussons pour le traitement de la paraffine. Sa doublure intérieure permet de maintenir la température pour un résultat de traitement optimal.

Luvas para o tratamento de parafina. Seu revestimento interno permite manter a temperatura para um resultado de tratamento ideal.

Pack 50 sachets en plastique parafin**Pacote 50 parafina sacos plásticos**

REF. 06617

Sachets en plastique pour le traitement de la paraffine des mains et des pieds. Ils intensifient la chaleur et l'empêchent de s'évaporer rapidement.

Sacos de plástico para o tratamento de parafina nas mãos e nos pés. Intensificam o calor e evitam que evapore rapidamente.



Ponceuse à ongles professionnel 30.000 Rpm
Broca profissional 30,000 rpm1
u.m.vta8
box

REF. 06624



Excellente performance pour un travail professionnel. Moteur silencieux et poignée légère permettant de travailler confortablement.

- » Puissance : 45 W
- » Tension : 110 – 120 V
- » Poids stylo : 146 g.
- » Poids de base du moteur: 1250 g

Broca de excelente desempenho para um trabalho profissional. Motor silencioso e manipulo leve que permite trabalhar confortavelmente.

- » Potência: 45 W
- » Voltagem: 110 – 120 V
- » Peso manipulo: 146 g.
- » Peso básico do motor: 1250 g

**Ponceuse à ongles professionnel 30.000 Rpm**
Broca profissional 30,000 rpm1
u.m.vta12
box

REF. 06625

Ponceuse à ongles avec un rapport qualité / prix fabuleux. Silencieux et durable conçu pour le professionnel et l'apprenti.

- » Puissance : 30 W
- » Tension : 110 – 120 V
- » Poids stylo : 130 g.
- » Poids de base du moteur: 730 g

Bateria não incluída
Com uma relação preço / qualidade fabulosa.
Silencioso e durável projetado para o profissional e o aprendiz

- » Potência: 30 W
- » Voltagem: 110 – 120 V
- » Peso manipulo: 130 g.
- » Peso básico do motor: 730 g

Comprend: 6 accessoires + 6 émeris
Inclui: 6 acessórios + 6 esmeril



Appareil manucure POCKET

Broca manucure POCKET

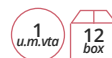

REF. 06695

- » Puissant, silencieux et portable
- » Design compact, idéal pour voyager
- » Très léger
- » 10 heures d'autonomie
- » Vitesse : 30 000 tr/min
- » Puissance : 24 W
- » Capacité de la batterie : 2 000 mA (11.1 V)
- » Temps de charge de la batterie : 2 heures
- » Durée de la batterie à vitesse maximale : 10 heures
- » Très silencieux, ne chauffe pas, ne vibre pas
- » Poids base : 283 g.
- » Poids stylo : 157 g.
- » Tension : 110 – 220 V
- » Catégorie II 50/60 Hz

- » Potente, silencioso e portátil
- » Design compacto perfeito para viajar
- » Muito leve
- » 10 horas de autonomia
- » Velocidade: 30 000 R.P.M.
- » Potência: 24 W
- » Capacidade da bateria: 2000 mA (11.1V)
- » Tempo de carregamento da bateria: 2 horas
- » Duração da bateria à velocidade máxima: 10 horas
- » Muito silencioso, não aquece nem vibra
- » Peso bateria portátil: 283 g.
- » Peso manípulo: 157 g.
- » Voltagem: 110 – 220 V
- » Classe II 50/60 Hz

Comprend: 6 accessoires + 6 émeris
Inclui: 6 acessórios + 6 esmeril



Appareil manucure QUICK

Torno manicure QUICK



REF. 06696

- » Puissant et silencieux
- » Design compact, idéal pour voyager
- » Très léger
- » Vitesse : 30 000 tr/min
- » Puissance : 24 W
- » Très silencieux, ne chauffe pas, ne vibre pas
- » Poids base : 341 g.
- » Poids stylo : 155 g.
- » Tension : 110 – 220 V.
- » Catégorie 50/60 Hz.

- » Potente e silencioso
- » Design compacto perfeito para viajar
- » Muito leve
- » Velocidade: 30 000 R.P.M.
- » Potência: 24W
- » Muito silencioso, não aquece nem vibra
- » Peso torno: 341 g.
- » Peso manípulo: 155 g.
- » Voltagem: 110 – 220 V.
- » Classe II 50/60 Hz.

Comprend: 6 accessoires + 6 émeris
Inclui: 6 acessórios + 6 esmeril



Pièces de recharge pour ponceuses

Peças de reposição para brocas



- » Mandrin adaptateur pour cylindres fraiseurs
 » Mandril adaptador para cilindros esmeriles

REF. 06779

- » Brosse de polissage
 » Ø 0,65
 » Escova polidora
 » Ø 0,65

REF. 06780

- » Cône en pierre feutre
 » Ø 0,6
 » Cone de pedra feltro
 » Ø 0,6

REF. 06781



- » Fraise pierre forme de tonneau
 » Ø 0,6
 » Fresa pedra forma de barril
 » Ø 0,6

REF. 06782

- » Fraise pierre conique
 » Ø 0,4
 » Fresa pedra cónica
 » Ø 0,4

REF. 06783

- » Fraise diamant avec pointe ronde
 » Fresa diamante com ponta redonda

REF. 06784



- » Fraise diamant cylindrique forme
 » Fresa diamante cilíndrica forma

REF. 06785

- » Fraise diamant cylindrique tonneau
 » Fresa diamante cilíndrica barril

REF. 06786

- » Fraise diamant cylindrique tonneau
 » Fresa diamante cilíndrica barril

REF. 06787



Pièces de recharge pour ponceuses
Peças de reposição para brocas

» Fraise diamant
cylindrique
tonneau
» Fresa diamante
cilíndrica barril

REF. 06788

» Fraise diamant aiguille
» Fresa diamante agulha

REF. 06789

» Fraise en silicone polissage
grain
» Fresa de silicone polidora
grão

REF. 06790

» Fraise en céramique
tonneau diamètre
» Ø 0,66
» Fresa de cerâmica
barril diâmetro
» Ø 0,66

REF. 06791

» Fraise céramique
tonneau avec pointe
arrondie
» Ø 0,66
» Fresa cerâmica barril com
ponta redonda
» Ø 0,66

REF. 06792

» Fraise céramique aiguille
diamètre
» Ø 0,23
» Fresa cerâmica agulha
diâmetro
» Ø 0,23

REF. 06793

» Fraise céramique conique diamètre
» Ø 0,6
» Fresa cerâmica cônica diâmetro
» Ø 0,6

REF. 06794

» Fraise tungstène bleu conique
» Ø 0,6
» Fresa tungstênio azul cônica
» Ø 0,6

REF. 06795

Kit ponceuse à ongle accessoires

Kit acessórios broca

- » 6 accessoires + 6 émeris
- » 6 acessórios + 6 cilindros esmerilidos

1
u.m.vta

500
box

REF. 06626



Distributeur de 100 emobuts emeri

Dispensador de 100 cilindros esmerilidos

1
u.m.vta

30
box

- » Fin
- » Durete: 180

REF. 06627

- » Moyen
- » Durete: 120

REF. 06628

- » Gros grain
- » Durete: 80

REF. 06629

- » Fino
- » Dureza: 180

- » Médio
- » Dureza: 120

- » Grosso
- » Dureza: 80



Ponceuse à ongles électrique PROMED 620

Broca PROMED 620



REF. 04103



- » Puissance: 21W
- » Ponceuse à Ongles Electrique à double sens
- » La plus petite Ponceuse à Ongles Electrique professionnelle de table sur le marché.
- » Adaptée pour le traitement des ongles des mains et des pieds, ainsi que les faux ongles et les ongles en gel ou en acrylique.
- » Élimine facilement les callosités et la dureté.
- » Petite taille: 110 x 90 x 80 mm.
- » Résistante à l'acétone avec moteur refroidi (75g.).
- » Support d'appui pour la Ponceuse intégré dans la base.
- » Comprend différentes fraises et embouts (10 accessoires + 30 émeris)
- » Fermeture rapide automatique pour fraises ou embouts standard de 2,25 mm
- » Interrupteur avec protection contre la poussière.
- » Vitesse réglable en continu jusqu'à 20 000 tr / min.
- » Tension: 115-230V~
- » Fréquence 50/60 Hz

- » Potência: 21W
- » Broca duplo sentido de rotação
- » A broca profissional de mesa mais pequena do mercado.
- » Indicada para o tratamento de unhas das mãos e pés, como para unhas artificiais, de gel ou acrílicas.
- » Elimina facilmente calos e durezas.
- » Tamanho reduzido: 110 x 90 x 80 mm.
- » Resistente à acetona, com motor refrigerado (75g.). *Suporte de apoio da broca integrado na base.
- » Inclui diferentes limas e ponteiras (10 acessórios + 30 esmeris)
- » Fecho rápido automático para brocas ou ponteiras de 2,25mm
- » Interruptor com proteção contra entrada de pó.
- » Velocidade continua regulável até 20,000 r.p.m.
- » Voltagem: 115-230V ~
- » Frequência 50/60 Hz

Ponceuse à ongles promed perfect

PROMED PERFECT broca



REF. 03222

- » Puissance: 21W
- » 12.000 tr / min.
- » Double sens.
- » 10 accessoires + 30 émeris + 1 brosse
- » Lumière froide intégrée pour éclairer la zone de travail
- » Tension: 220-230V~
- » Fréquence 50 Hz

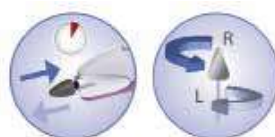

- » Potência: 21W
- » 12,000 r.p.m.
- » Duplo sentido de rotação.
- » 10 acessórios + 30 esmeris + 1 escova
- » Luz fria incorporada para iluminar a zona a trabalhar
- » Voltagem: 220-230V ~
- » Frequência 50 Hz



Ponçeuse à ongles MP840 Broca MP840

1
u.m.vta

4
box

REF. 06444

- » manucure/pédicure
- » manicure e pedicure



Ponçeuse à ongles MP815 Broca MP815

1
u.m.vta

4
box

REF. 06443

- » manucure/pédicure
- » manicure e pedicure



Pour le soin et le traitement des ongles, des cuticules et des callosités

- » Puissance: 9W
- » Batterie non incluse AA
- » Vitesse de rotation: 2 niveaux de 3.500/4.600 tr / min
- » Longueur du câble: 1,5 m
- » Poids: 101 gr
- » Tension: 230V ~, 50Hz
- » Il a une lumière led pour une application plus précise
- » Faire pivoter à droite et à gauche
- » Design ergonomique
- » Convient aux diabétiques
- » S'arrête automatiquement lorsque la pression est trop élevée
- » Avec sac de rangement

Comprend:

- » 2 rouleaux de polissage et 2 rouleaux de polissage
- » 7 accessoires de haute qualité pour différentes applications

Para o cuidado o tratamento de unhas, cutículas e calos

- » Potência: 9W
- » Bateria não incluída AA
- » Velocidade de rotação: 2 níveis de 3.500 / 4.600 rpm
- » Comprimento do cabo: 1,5 m
- » Peso: 101 gr
- » Tensão: 230V ~, 50Hz
- » Tem uma luz led para uma aplicação mais precisa
- » Roda para a direita e para a esquerda
- » Design ergonômico
- » Adequado para diabético
- » Pára automaticamente quando a pressão é muito alta

Inclui:

- » 2 rolos de polimento
- » 7 acessórios de alta qualidade para diferentes aplicações

Pour le soin et le traitement des ongles, des cuticules et des callosités

- » Puissance: 9W
- » Batterie non incluse AA
- » Vitesse de rotation: 2 niveaux de 3.500/4.600 tr / min
- » Longueur du câble: 1,5 m
- » Poids: 101 gr
- » Tension: 230V ~, 50Hz
- » Il a une lumière led pour une application plus précise
- » Faire pivoter à droite et à gauche
- » Design ergonomique
- » Convient aux diabétiques
- » S'arrête automatiquement lorsque la pression est trop élevée
- » Avec sac de rangement

Para o cuidado e tratamento de unhas, cutículas e calos

- » Potência: 9W
- » Bateria não incluída AA
- » Velocidade de rotação: 2 níveis de 3.500 / 4.600 rpm
- » Comprimento do cabo: 1,5 m
- » Peso: 101 gr
- » Tensão: 230V ~, 50Hz
- » Tem uma luz led para uma aplicação mais precisa
- » Roda para a direita e para a esquerda
- » Design ergonômico
- » Adequado para diabético
- » Pára automaticamente quando a pressão é muito alta

Pièces de rechange pour ponceuses
Peças de reposição para brocas1
u.m.vta10
box

REF. 06444



REF. 06443

» Cône feutre
» Cone feltro

REF. 02149

» Cône saphir à grain fin
» Cone Safira grão fino

REF. 02150

» Cône saphir à gros grain
» Cone Safira grão grosso

REF. 02151

» Disque saphir fin
» Disco Safira grão fino

REF. 02152

» Fraise à saphir ronde
» Lima safira

REF. 02153

» Saphir fraise aiguille
» Cortador de agulha

REF. 02154

» Gros cône de saphir
» Grande cone de safira

REF. 02155

» Pousse-cuticules
» Espurra cutículas

REF. 02156

» Fraise saphir cylindrique
» Lima cilíndrica

REF. 02157

» Grain saphir grossier
» Disco Safira grão grosso

REF. 02158

» Fraise ovale en saphir
» Lima safira ovalada

REF. 02159

» Balai de pédicure
» de soin de pied
» Escova

REF. 02164

» Sachet contenant 100 émeris
pour ponceuse à Ongles
» Saco de 100 u. cilindro esmerilMoyen · Médio
REF. 02978Gros grain · Grosso
REF. 02979» Adaptateur de fraises
» Adaptador de Limas

REF. 02165

» Adaptateur avec 30 Tube émeris pour
ponceuse électrique
» Adaptador com 30 tubos de esmeris

REF. 02160



Pièces de rechange pour tours
Peças de reposição para brocas1 u.m.vta
10 box

REF. 04103



REF. 03222

» Embout de ponceuse
» pédicure saphir
» Esmerilador Cónico Safira

REF. 02958

» Fraise saphir pointue
» Lima pontiaguda safira

REF. 02959

» Fraise saphir ronde
» Lima redonda safira

REF. 02960



*



*



*

» Disque saphir grossier
» Cilindro lima safira

REF. 02961

» Cône de polissage / filtre
» Cone polidor/ filtro

REF. 02962

» Mandrin pour émeri
» Adaptador cilindro
esmeril

REF. 02976



*



*



*

» Polisseur moyen en silicone
» Polidor silicone médio

REF. 02980

» Polisseur épais en silicone
» Polidor silicone grosso

REF. 02981

» Fraise longue
» Lima larga

REF. 02982



*



*



*

» Embout de ponceuse
pédicure, callosités
» Esmerilador pedicure
calosidades

REF. 02983

* Non stérilisable à pression ou température (autonettoyant, stérilisateur à quartz)
Désinfectable uniquement avec un désinfectant ou de l'alcool* Não esterilizável com pressão ou temperatura (autolavagem, esterilizador de
quartzo)
Desinfetável apenas com desinfetante ou álcool

*

Sachet contenant 100 embouts émeri pour ponceuse à ongles
Pacote de 100 u. cilindro esmeril1 u.m.vta
10 box

Moyen · Médio

Grossier · Grosso

REF. 02978

REF. 02979

Disque saphir grain moyen
Disco safira grão médio» Pour appareil de manucure-pédicure
» Para torno de manicure-pedicure1 u.m.vta
12 box

REF. 07237



NEW

Lampe loupe avec Lumiere Lupa com luz

1 u.m.vta
4 box

REF. 03821



- » Puissance: 5W
- » Lentille 5 dioptries
- » Diamètre de la lentille: 10.16 cm
- » Éclairage: 48 LEDS
- » Couverture de protection pour lentille, base de loupe pour bureau
- » Tension: 220-240V~
- » Fréquence 5 Hz

- » Potência: 5W
- » Lente de 5 dioptrias
- » Diâmetro da lente: 10,16 cm
- » Iluminação: 48 LEDS
- » Tampa protetora para a lente, base da lupa reforçada para maior estabilidade
- » Voltagem: 220-240V ~
- » Frequência 5 Hz

Lampe loupe avec lumière Lupa com luz

1 u.m.vta
1 box

REF. 04948



- » Puissance: 6W
- » Lentille 5 dioptries
- » 60 leds Smd a 6 niveaux de graduation en mode froid et chaud
- » 800 lumen
- » Maximum de lumière, avec une reproduction très réelle des couleurs, longue durée et très faible consommation
- » Indice de rendu des couleurs, 80% reproduisant fidèlement les couleurs
- » Ne génère pas de chaleur
- » Diamètre loupe de verre 12,7 cm
- » Épaisseur du verre de 0,5 à 2,1 cm
- » 100-240V ca 50-60hz

- » Potência: 6W
- » Lente de 5 dioptrias
- » 60 leds Smd tem 6 níveis de graduação em modo frio e quente
- » 800 lumen
- » Luz máxima, com reprodução muito real das cores, longa duração e consumo muito baixo
- » Índice de reprodução de cor, é de 80% reproduzindo as cores fielmente
- » Não gera calor
- » Lupa de vidro de diâmetro 12,7 cm
- » Espessura de vidro de 0,5 a 2,1 cm
- » 100-240V CA 50-60hz



Lampe loupe avec lumière Lupa com luz

1 u.m.vta
10 box

REF. 04624

REF. 04947

- » Lampe de table manucure avec pied et clip.
- » Lentille 5 dioptries
- » Taille de lentille : 100 mm
- » Éclairage: 30 LED SMD
- » Tension: 100-240V
- » Fréquence: 50/60 Hz
- » Puissance maximale: 6 w
- » Bras du type col de cygne pour support loupe
- » Pince de table antidérapante incluse
- » Utilisation en intérieur
- » 560 lumen pour un usage professionnel.

- » Lâmpada para mesa de manicure com base
- » Lente de 5 dioptrias
- » Tamanho da lente: 100 mm
- » Iluminação: 30 led smd
- » Voltagem: 100-240V
- » Frequência: 50/60 Hz
- » Potência máxima: 6 w
- » Braço para suporte da lupa
- » Clip antiderrapante incluído para mesa
- » Utilizar em interiores
- » 560 lumen para uso profissional

Sans accessoire
Sem acessório



Avec accessoire
supplémentaire pour la
table d'accrochage

Com acessório extra
para mesa

Lampe- loupe avec lumière Lupa com luz

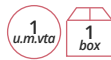

- » Puissance: 22W
- » Taille de la lentille : 12,7 cm.
- » Capuchon de protection pour lentille
- » Bras articulé pour support de loupe.
- » Mâchoire incluse pour le bureau

- » Potência: 22W
- » Tamanho da lente: 12,7 cm.
- » Tampa protetora para a lente.
- » Braço articulado para suporte da lupa.
- » Incluído para fixar à mesa.

3 dioptries
3 dioptrias
REF. 03815

5 dioptries
5 dioptrias
REF. 03816

8 dioptries
8 dioptrias
REF. 03817

Pieds de lampe Base para a lupa



REF. 03820



REF. 03819



REF. 04110

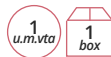

3 dioptries
3 dioptrias
REF. 04107

5 dioptries
5 dioptrias
REF. 04108

8 dioptries
8 dioptrias
REF. 04109

Lampe- loupe led smd Lupa com led smd



- » Puissance: 22W
- » Taille de la lentille : 12,7 cm.
- » 60 Leds smd et 570 lumens.
- » Lumière maximale, avec une reproduction très réelle decouleurs, longue durée et très faible consommation 6W.
- » Elle ne génère pas de chaleur.

- » Potência: 22W
- » Tamanho da lente: 12,7 cm.
- » 60 Leds smd e 570 lumens.
- » Máxima luz, com reprodução muito real das cores
- » Longa duração e baixo consumo 6W.
- » Não aquece.

* Compatible aux références
03815, 04107, 04198 y 04109
* Adaptável a referências
03815, 04107, 04198 y 04109

Sachet de limes: droites
Pacote limas: reta

Grossier 0,6 cm
 Grosso 0,6 cm



Poids: 10 gr.
 Peso: 10 gr

80/100

100/150

REF.06697

REF.06698



100/180

180/240

REF.06010

REF.06699



Sachet de limes: courbée
Pacote limas: curvada

Grossier 0,6 cm
 Grosso 0,6 cm



80/100

100/150

REF.06700

REF.06701



100/180

180/240

REF.06011

REF.06702



Sachet de limes: polissage
Pacote limas: meia-lua

Grossier 0,6 cm
 Grosso 0,6 cm



Poids: 10 gr.
 Peso: 10 gr

80/100

100/180

REF.06703

REF.06704

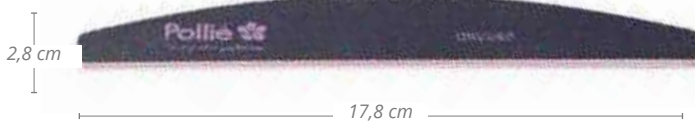

100/180

180/240

REF.06012

REF.06705

Sachet de limes: rocket
Pacote limas: rocket

Grossier 0,6 cm
 Grosso 0,6 cm



REF.06013

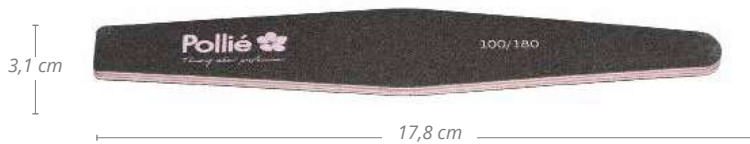

Sachet de limes: la forme carré
Pacote limas: quadrada

Grossier 0,6 cm
 Grosso 0,6 cm



100/180

REF.06014

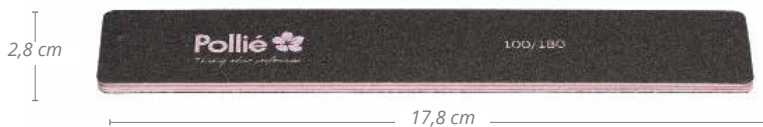

Manche métallique pour lime Cabo metálico para lima



REF.07222

Droite
Reta

NEW



Polissage
Meia-lua

NEW

REF.07223



Pack 48 pièces de rechange lime noir Pack 48 recargas lima preto



REF.07225

Droite
Reta

NEW

#240

REF.07224

Polissage
Meia-lua

NEW

#240



17,9 cm



17,9 cm

Pack 48 pièces de rechange lime Blanc
Pack 48 recargas lima Branco



Droite
Reta

NEW

#100
 REF.07228

Polissage
Meia-lua

NEW

#100
 REF.07229



17,9 cm



17,9 cm

Pack 48 pièces de rechange lime ZÈBRE
Retx 48 recargas lima ZEBRA



NEW

#150
 REF.07226

Polissage
Meia-lua

NEW

#150
 REF.07227



17,9 cm



17,9 cm

Lime 12 unités
Lima 12 unidades



Droite
Reta

Choisissez le grammage qui vous convient le mieux

Escolha a gramagem que melhor se adequa a você



100/180

REF.06000

80/80

REF.06020

100/100

REF.06021

180/180

REF.06022

240/240

REF.06023

400/400

REF.06024

600/600

REF.06025

Courbée
Curvada

100/180

REF.06001



Polissage
Meia-lua

100/180

REF.06002



Rocket
Rocket

100/180

REF.06003



La forme carrée
Quadrada

100/180

REF.06004



Sachet de limes
Pacote limas



Droite
Reta

100/180

REF.06015



Courbée
Curvada

100/180

REF.06016



Polissage
Meia-lua

100/180

REF.06017



Rocket
Rocket

100/180

REF.06018



La forme carrée
Quadrada

100/180

REF.06019



Lime 12 unités
Lima 12 unidades

Grossier 0,6 cm
Grosso 0,6 cm



Droite
Reta



100/180

REF.06005

Courbée
Curvada



100/180

REF.06006

Polissage
Meia-lua



100/180

REF.06007

Rocket
Rocket



100/180

REF.06008

La forme carrée
Quadrada



100/180

REF.06009



Lime noire rembourrée
Lima cor preto acolchoada

Grossier 0,3 cm
Grosso 0,3 cm



100/180

REF.03427

Droite
Reta



100/180

REF.03428

Courbée
Curvada



100/180

REF.03429

La forme carrée
Quadrada



Lime professionnelle zèbre, matelassée 12 unités
Lima profissional zebra acolchoada 12 unidades

Grossier 0,3 cm
Grosso 0,3 cm



100/180

REF.03425

Droite
Reta



100/180

REF.03424

Courbée
Curvada



100/180

REF.03426

La forme carrée
Quadrada



100/180 Lavable et désinfectable. Abrasive complet et usage professionnel. Gran durabilité. Recommandé pour ongles en gel et en acrylique.

100/180 Lavável e desinfetável. Sistema abrasivo completo e profissional. Durabilidade extra Lima 2 vezes mais rápido que as limas. Excelente para unhas de gel e acrílico

Pack 12 lime rem bourré
Pacote 12 lima acolchoada

Grossier 0,8 cm
Grosso 0,8 cm



Droite
Reta



100/180
REF.06358

100/180
REF.06360

Courbée
Curvada



100/180
REF.06359

100/180
REF.06361

Paquet de 50 limes. Usage professionnel
Pacote de 50 limas. Uso profissional

Grossier 0,13 cm
Grosso 0,13 cm



- » Système abrasif complet et professionnel.
- » Grande durabilité
- » Lime 2 fois plus rapidement que les limes conventionnelles.
- » Excellent résultat sur les ongles en gel et en acrylique.

- » Sistema abrasivo completo e profissional.
- » Durabilidade extra
- » Lima 2 vezes mais rápido que os arquivos convencionais.
- » Excelente uso para unhas de gel e acrílico.



100/180
REF.06812

100/180
REF.06813



Lime noire 2 faces
Lima preta 2 lados.

Lime blanc 2 faces
Lima branca 2 lados.



Lime américaine noire
Lima americana cor preto

10
u.m.vta

1500
box

100/180

REF.01027



Pack 12 lime épaisse noire
Pacote 12 lima grossa preto

Grossier 0,3 cm
 Grosso 0,3 cm

1
u.m.vta

40
box

100/180

REF.01030



100/180

REF.01421

Sachet de limes
Pacote limas

Grossier 0,4 cm
 Grosso 0,4 cm

12
u.m.vta

600
box

100/180

REF.01200



Pack 12 lime usage professionnelle. Motif zèbre. Rembourrée
Pacote 12 lima profissional zebra acolchoada

Grossier 0,3 cm
 Grosso 0,3 cm

1
u.m.vta

40
box

100/180

REF.03731

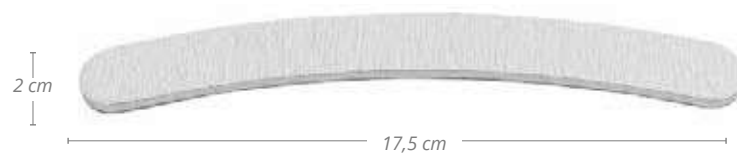
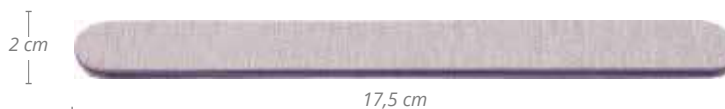

100/180

REF.03730

Sachet de 10 lime en carton
Pacote 10 limas cartão

Grossier 0,12 cm
 Grosso 0,12 cm



REF.00601



Sachet de 6 lime en carton
Pacote 6 limas cartão

Grossier 0,3 cm
 Grosso 0,3 cm



REF.01107



Grossier 0,12 cm
 Grosso 0,12 cm



REF.00602



Kit de de 20 limes R.601-602 (10 + 10)
Pacote 20 limas R.601-602 (10 + 10)



Grossier 0,12 cm
 Grosso 0,12 cm



REF.00621



Sachet de 5 limes américaines rouges
Pacote 5 limas americanas vermelhas



Grossier 0,12 cm
 Grosso 0,12 cm



REF.01517

Paquet de 10 grandes limes
Pacote 6 limas

» Grande
 » Grande

Grossier 0,12 cm
 Grosso 0,12 cm



REF.01115



» Petites
 » Pequena

Grossier 0,12 cm
 Grosso 0,12 cm



REF.01116





**Manucure parfaite
EN COULEUR**

**Manicures perfeitos
COM COR**

Poche 5 limes couleurs variées
Pacote 5 limas cores variadas

Grossier 0,6 cm
Grosso 0,6 cm



180

REF.06367

- » Une face pailletée, l'autre grammage 180
- » Uma face purpurina e a outra gramagem 180

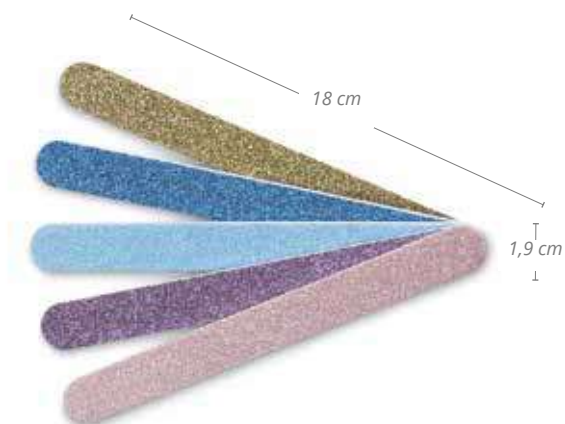

Sachet 5 limes motif animaux
Pacote 5 limas estampados animais

Grossier 0,6 cm
Grosso 0,6 cm



180/240

- » Motif animaux
- » Estampados animais

REF.06365

- » Motif variées
- » Estampados variadas

180/240

REF.06366

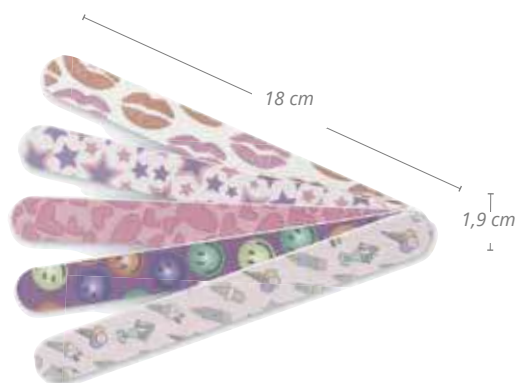
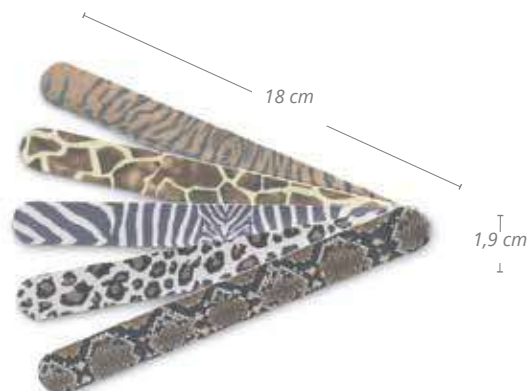

Présentoir de 42 limes Expositor de 42 limas

- » 6 modèles x 7 unités
- » Une face pailletée, l'autre abrasive grain 180
- » Couleurs assorties

- » 6 modelos x 7 unidades
- » Uma face purpurina e a outra lima de gramagem 180
- » Cores variadas



180

REF.06416

Présentoir de 48 limes Expositor de 48 limas

- » 6 modèles x 8 unités chacun.
- » Motif animaux

- » 6 modelos x 8 unidades de cada.
- » Estampados animais



180/240

REF.06415



18 x 1,9 x 0,6 cm



18 x 1,9 x 0,6 cm

Présentoir de 42 limes imprimés Expositor de 42 limas estampadas

- » 6 modèles x 7 unités chacun
- » Motif variées

- » 6 modelos x 7 unidades.
- » Estampados variadas



180/240

REF.06414

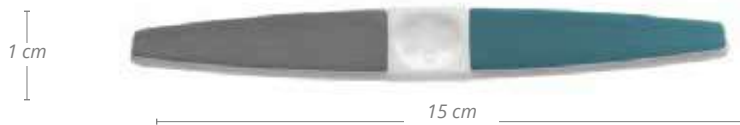

18 x 1,9 x 0,6 cm

Lime polir les ongles
Lima polidora unhas» 4 utilisations
» 4 USOSGrossier 0,3 cm
Grosso 0,3 cm12 u.m.Vta
360 box

REF.01029

» 3 utilisations
» 3 USOS12 u.m.Vta
240 box

REF.06363

» 3 utilisations
» 3 USOS12 u.m.Vta
84 box

REF.06362

Lime de polissage demi-lune avec étui
Lima polidora meia lua com bolsa12 u.m.Vta
60 box

100/180

REF.06706

Lime rouge rocket avec étui
Lima vermelha rocket com bolsa12 u.m.Vta
144 box

80/80

REF.06712

Lime polissage rectangulaire

Lima retangular polir

12
u.m.vta

120
box

Bloc 4 Faces

Lima bloco 4 faces

12
u.m.vta

216
box

REF.01380

240/320/400/600

REF.06029

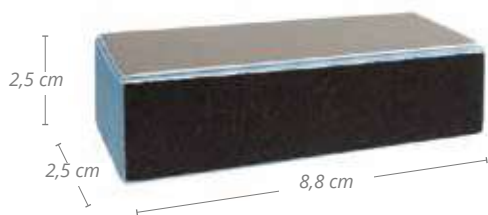

20 limes bloc 4 Faces

20 limas bloco 4 faces

» Lilas

» Lilás

1
u.m.vta

46
box

80/80/100

REF.06030



12
u.m.vta

216
box

» Orange

» laranja

100/180/180

REF.06027



1
u.m.vta

46
box

» Orange

» laranja

100/180/180

REF.06031



12
u.m.vta

216
box

» Blanc

» Branca

120

REF.06028



1
u.m.vta

56
box

» Blanc

» Branca

120

REF.06032



Boîte de 50 blocs mini à
Caixa de 50 mini blocos

La lime idéale pour égaliser les grandes surfaces, que ce soit sur des ongles naturels ou artificiels.

A lima ideal para igualar as grandes superfícies, seja sobre unhas naturais ou postiças.

» 2 faces
 » couleur blanc

» 2 faces
 » cor branca

120/120

REF.06708

Sachet de 6 blocs mini
Pacote de 6 mini blocos

» 2 faces
 » couleur blanc

» 2 faces
 » cor branca

120/120

REF.06707

Limes ongles en verre
Limas de cristal

» 2 côtes
 » 2 lados



Lilas
 Lilás

REF.06630/68



Rosa
 Rose

REF.06630/70



Lime à ongles Saphire avec manche
Lima Saphire com punho

12
u.m.vta

12
box

REF.00841



REF.00842



REF.00843



REF.00844



REF.00845



Coussin repose-main blanc
Almofada apoia mãos branca

1
u.m.vta

50
box

REF.04969

» Pour que les séances de manucure soient plus confortables aussi bien pour le client que pour l'esthéticienne
 » Para que a manicure seja mais cômoda, tanto para o cliente como para a esteticista.



Stérilisateur · Esterilizador

Stérilisateur chaleur sèche *sanity security*
Esterilizador calor seco *sanity security*

REF. 03011

- » Puissance: 400W
 - » 20°C - 200°C
 - » Tension: 220-240V~
 - » Fréquence 50 Hz
- » Potência: 400W
 - » 20°C - 200°C
 - » Voltagem: 220-240V~
 - » Frequência 50 Hz

**Stérilisateur germicide *GX4***
Esterilizador germicida *GX4*

- » Puissance: 400W
- » 20°C - 200°C
- » Ultra plat
- » Lumière germicide de haute qualité

- » Potência: 400W
- » 20°C - 200°C
- » Ultra plano.
- » Luz germicida elevada qualidade



REF. 03009/59

REF. RE00891/01

Ampoule de rechange
Lâmpada de substituição**Stérilisateur *GX7 orange***
Esterilizador *GX7 laranja*

REF. 03010/64

- » Puissance: 75W
- » 200°C
- » Capacité 120 cc
- » Billes de quartz
- » Tension: 220-240V~
- » Fréquence 50 Hz

- » Potência: 400W
- » 200°C
- » Capacidade 120 cc
- » Com esferas de quartzo
- » Voltagem: 220-240V~
- » Frequência 50 Hz

**Pièces de rechange**
Recargas

- » Sachet de rechange de balles de quartz.

- » Saco com recargas de esferas de quartzo.

REF. RE03010/64/01

Pot de quartz sphères 500 gr Caixa de esferas de quartzo 500 gr



- » Quartz
- » Idéal pour les ustensiles tels que les peignes, les ciseaux

- » Quartzo
- » Ideal para utensílios como pentes, tesouras

REF. 07013

Pot de quartz sphères Esferas de quartzo



- Stériliser des outils métalliques pour la coiffure et l'esthétique
- » Puissance: 400W
- » 20°C - 200°C

500 gr

REF. 06619

- Esterilizar ferramentas metálicas para cabeleireiro e estética
- » Potência: 400W
- » 20°C - 200°C



Stérilisateur UV eurostil en plastique esterilizador de plástico UV EUROSTIL



- Stérilisateur à rayons ultraviolets pour tout type d'outils aussi bien de coiffure que d'esthétique
- » Puissance: 8W

REF. 06618

- Esterilizador de raios ultravioleta para todo o tipo de ferramentas tanto de cabeleireiro como de estética
- » Potência: 8W



REF. RE06618/01

Ampoule de rechange
Lâmpada de substituição

Pincès coupe-cuticules

Alicates corta cutículas



La gamme de produits PREMIUM de Pollié est conçue et fabriquée pour répondre au mieux à vos besoins. Fabriquée avec de l'acier inoxydable. Pollié Premium offre la meilleure qualité et performance dans ses nouvelles pincès à ongles et cuticules, les dernières étapes de leurs fabrications sont faites à la main pour obtenir la pince parfaite

A gama de produtos PREMIUM de Pollié está concebida e fabricada para satisfazer ao máximo as suas necessidades. Fabricados com aço inoxidável. Pollié Premium oferece a melhor qualidade e rendimento nos seus novos alicates para unhas e cutículas, os últimos passos da sua fabricação são feitos à mão para conseguir o alicate perfeito.

» Double ressort tournant et bec de 5,5 mm
» Encaixe mola boca 5,5 mm

REF. 04659



» Double ressort tournant et bec de 4,5 mm
» Encaixe mola boca 5,5 mm

REF. 04660



» Double ressort tournant et bec de 5,5 mm
» Encaixe mola boca 5,5 mm

REF. 04661

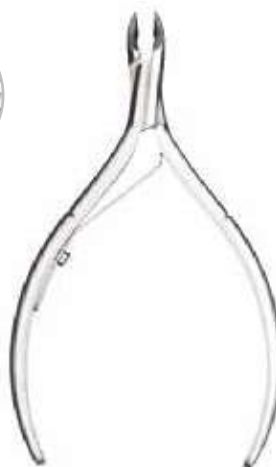

Pince coupé-ongles

Alicate corta-unhas



» Coupe simple
» Encaixe simples

REF. 04662



» Coupe simple
» Encaixe simples

REF. 04663



Pince coupe cuticules**Alicate cortacutícula**

» Ronde. Bleu titane
» Redondo. Azul titânio



1 u.m.vta
12 box

REF.03243

» Bleu titane
» Azul titânio



1 u.m.vta
12 box

REF.03244

» Bleu titane
» Azul titânio



1 u.m.vta
12 box

REF.03245

» Bleu titane
» Azul titânio



1 u.m.vta
12 box

REF.04697



» Avec fermeture
» Com fecho



1 u.m.vta
12 box

REF.01275

Pince coupe cuticules Alicata cortacutícula

- » Bec de 5mm
- » Boca 5mm



10 cm

1
u.m.vta

12
box

REF.04692



10 cm

1
u.m.vta

12
box

REF.01272

- » Ajustée
- » Encaixado



8 cm

1
u.m.vta

12
box

REF.02125



11 cm

1
u.m.vta

12
box

REF.03688

Pince à cuticules**Alicata cutícula**

- » Ressort recharge + vis pour pince
- » Acier au carbone

- » Recarga mola + parafusos
- » Aço de carbono



REF.02264

- » Extra-fine
- » Extrafino



REF.02679



REF.02404



- » De forme ronde
- » Bec 3 mm

- » Redondo
- » Boca 3 mm



REF.03018

- » De forme ronde
- » Bec 5 mm

- » Redondo
- » Boca 5 mm



REF.03019

- » Bec 4 mm
- » Boca 4 mm



REF.03039

- » Manche satiné
- » Cabo acetinado



REF.02812

Pince coupe cuticules
Alicate cortacutícula1
u.m.vta12
box**En acier chirurgical · Aço surgical**

- » Bec 2 mm intégré
- » Boca 2 mm

REF.02265**Pince coupe cuticules**
Alicate cortacutícula1
u.m.vta12
box

- » Bec 3 mm
- » Acier inoxydable

REF.03685

- » Boca 3 mm
- » Aço inoxidável



- » Bec de 4 mm intégré
- » Boca 4 mm encaixada

REF.02266

- » Bec 4 mm
- » Acier inoxydable

REF.03686

- » Boca 4 mm
- » Aço inoxidável



- » Bec de 6 mm intégré
- » Boca 6 mm encaixada

REF.02267

- » Bec 5 mm
- » Acier inoxydable

REF.03687

- » Boca 5 mm
- » Aço inoxidável



- » Ressort double de recharge + vis pour pince

1
u.m.vta1
box**REF.02405**

- » Recarga mola
- » + parafusos para alicate

Pince coupe-ongles
Alicata corta-unhas» Acier inoxydable
» Aço inoxidável

10 cm

REF.01271» Satinée
» Mate

12 cm

REF. 01276» Satinée
» Mate

10 cm

REF.02813

11 cm

REF.04693» Vec ressort à l'intérieur
» Bleu titane» Com mola interior
» Azul titânio

11 cm

REF.04696» Bleu titane
» Azul titânio

10 cm

REF.03240

Pince coupe cuticules
Alicante corta cutícula12
u.m.vta12
box**REF.01069**» Blanc
» Branco**REF.01336**» Blanc avec limes
» Branco com lima**REF.02836**» Lilas avec caoutchouc
» Lilás com borracha**REF.04411**» Couleurs assorties et en
caoutchouc
» Diferentes cores**REF.01037**» Lilas avec caoutchouc
» Lilás com borracha**REF.04589**

Coupe-ongles Corta-unhas

» Petit
» Pequeno



6 cm

REF.01064

» Grand
» Grande



8 cm

12
u.m.vta 12
box

REF.01038

Coupe-ongles avec réservoir Corta-unhas com depósito

» Petit
» Pequeno



6,6 cm

REF.04408

» Grand
» Grande



9 cm

12
u.m.vta 120
box

REF.04407

Coupe-ongles artificiels Corta-unhas artificial

1
u.m.vta 12
box

REF.01476



Set de manucure complet de 6 pièces Kit de manicure 6 peças completo

1
u.m.vta 1
box

REF.02746



Étui 11 ustensiles manucure Estojo 11 utensílios manicure

1
u.m.vta 1
box

REF.04882

» Capacité pour 20 ustensiles
» Capacidade para 20 utensílios



Étui pour pincas à peaux et coupe-ongles
Capa alicates peles e corta-unhas

» Petit
 » Pequeno



1 u.m.vta
 10 box

REF.02402

» Grand
 » Grande



1 u.m.vta
 10 box

REF.02403

Étui noir pour pincas et coupe ongles
Capa alicates e corta-unhas, cor preto

1 u.m.vta
 10 box

REF.02512



Étui pour pincas à épiler, petites limes à ongles et ciseaux de manucure
Capa pinças, limas pequenas e tesouras manicure



1 u.m.vta
 10 box

REF.02401



1 u.m.vta
 48 box

REF.02820

N°1

REF.02821



N°2

REF.02822



N°3

REF.02823



N°4

REF.02824



N°5

REF.02825



N°6

REF.02826



N°7

REF.02827



N°8

REF.02828



N°9

REF.02829



Comment préparer ses ongles avant de mettre du vernis ? Como preparar a unha para o verniz?

- » Toujours stériliser les outils de manucure qui seront utilisés
- » Limer et façonner l'ongle, au goût du client et les assortir.
- » Humidifiez l'ongle avec de l'eau
- » Poussez les cuticules avec un poussoir ou un Bâton d'orange
- » Enlever les peaux avec des pinces spéciales pour les peaux de manucure
- » Passez une lime à polir pour laisser l'ongle sans graisse et sans brillance
- » Humidifiez à nouveau l'ongle et séchez-le

- » Esterilizar sempre as ferramentas de manicure que se vão utilizar.
- » Limar e dar forma à unha, ao gosto do cliente e acertá-las.
- » Humedecer a unha com água.
- » Empurrar as cutículas com um empurrador.
- » Retirar as peles com um alicate especial para peles de manicure.
- » Passar uma lima para deixar a unha sem brilho.
- » Humedecer a unha de novo e secá-la.



Poussoir pour cuticules à double fonction en acier inoxydable Empurrador de cutículas duplo em aço inoxidável



1
u.m.vta

12
box

REF.04104



1
u.m.vta

24
box

REF.04688



1
u.m.vta

24
box

REF.04689

Poussoir pour cuticules en acier inoxydable Empurrador cutículas aço inoxidável



1
u.m.vta

24
box

REF.04687



1
u.m.vta

12
box

REF.04105

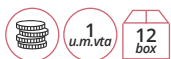
Brosse à ongles
Escova lima unhas» Rose avec poignée
» Rosa com alça

REF.06753

» Blanc avec poignée
» Branco com alça

REF.06754

» Grand, deux côtés
» Grande, duas faces

REF.00132

» Spéciale double
» Duplo especial

REF.02185

» Ongles avec poignées, grand
» Com asas, grande

REF.00774

» Ongles avec poignées, petit
» Com asas, pequeno

REF.00792

**Bol manucure en acier inoxydable**
Bacia aço inoxidável manicure

325 ml

REF.03732



Ø 10 cm

Bol manucure spécial
Bacia especial manicure

REF. 00889

**Bol de manucure pour le trempage des doigts de couleur naturelle, ergonomique**
Tigela molha dedos cor natural, ergonómica

REF.03399



Ciseaux ronds d'oreille et de nez
Tesoura de ponto redondo para orelha e nariz



REF.07087

Ciseaux bébé point roma
Tesoura bebê ponto roma



REF.07088

Pinces à pince 3 en 1
3 Em 1 forças de compressão



REF.07090

Ciseaux droits professionnels à ongles
Tesouras profissionais retas para unhas



REF.07353

Ciseaux à peau droits professionnels
Tesouras profissionais para peles retas

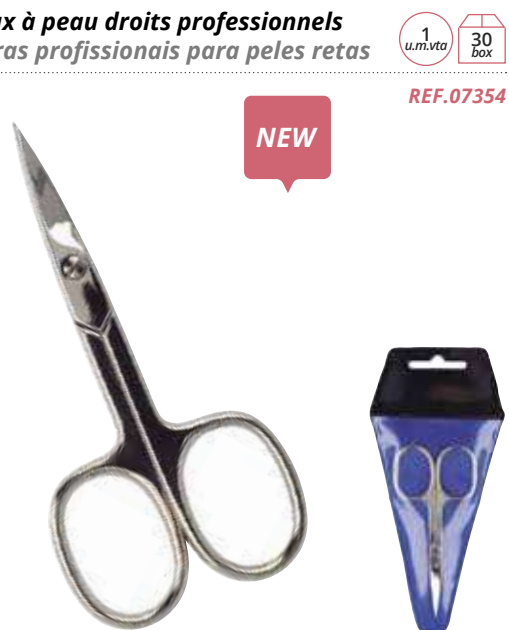

REF.07354

Ciseaux à peau Tesoura peles



NEW

3.5"

REF.07085



3.5"

REF.04690



3.5"

REF.01270

» Professionnel
» Profissional



REF.01989

» Pointe fine et surface
» de coupe courbée
» Curvada ponta fina



REF.03419



Ciseaux à ongles Tesoura unhas



NEW



3.5"

REF.07086



3.5"

REF.01269

» Professionnel
» Profissional



3.5"

REF.01990



3.5"

REF.04691



Sachet de bâtons de manucure cuticule en plastique
Pacote removedor de cutículas plástico

10 u		 $\varnothing 3,8\text{cm}$ 7,5 cm	 	REF.06567	
10 u		$\varnothing 3,8\text{cm}$ 11 cm	 	REF.01279	
» Bois » Madeira		$\varnothing 3,8\text{cm}$ 15,5 cm	 	REF.02716	
50 u		11,5 cm	 	REF.00121	
» Plastique » Plástico	100 u		$\varnothing 3,8\text{cm}$ 7,5 cm	 	REF.06565
» Bois » Madeira		$\varnothing 3,8\text{cm}$ 15 cm	 	REF.06566	
100 u		$\varnothing 3,8\text{cm}$ 12 cm	 	REF.00123	
» Bois » Madeira		$\varnothing 3,8\text{cm}$ 7,5 cm	 	REF.04525	
» Bois » Madeira		$\varnothing 3,8\text{cm}$ 12 cm	 	REF.04526	
» Bois » Madeira		$\varnothing 3,8\text{cm}$ 15 cm	 	REF.04527	

Pince coupe-ongles PÉDICURE

Alicata corta-unhas PEDICURE

- » Manche satiné
- » Acier inoxydable

- » Cabo mate
- » Aço inoxidável



12 cm

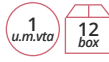

REF.03017

- » Manche satiné
- » Acier inoxydable

- » Cabo mate
- » Aço inoxidável



14 cm



REF.03016

- » Avec fermeture, finition brillant
- » Acier inoxydable

- » Com fecho, acabamento brilhante
- » Aço inoxidável



14 cm



REF.01474

- » Avec fermeture, finition brillant
- » Com fecho, acabamento brilhante



12 cm



REF.01475

- » Mate, avec fermeture
- » Mate, com fecho



14 cm



REF.04694

- » Mate, avec fermeture
- » Mate, com fecho



12 cm



REF.04695



Pince coupe-ongles PÉDICURE

Alicate corta-unhas PEDICURE



- » Double droit avec ressorts
- » Dupla reta com molas



14 cm

REF.07089

- » Oblique avec ressorts
- » Oblíquo com molas



14 cm

REF.07136

Coupe-ongles pédicure

Corta-unhas pedicure

- » Avec fermeture
- » Bleu titane

- » Com fecho
- » Azul titânio



12 cm



REF.03241

- » Avec fermeture
- » Bleu titane

- » Com fecho
- » Azul titânio



14 cm



REF.03242

Pincès coupe-ongles articulées pour pédicure - podologue

Alicates podólogo articulado



- » Avec étui
- » Com estojo

REF.03471

REF.02271



15 cm

Bol à pédicure en acier inoxydable
Bacia aço inoxidável pedicure

1 u.m.vta 10 box

7 L

REF.03733

**Sachet séparateurs d'orteils**
Pacote separa-dedos pedicure

- » 2 unités
- » Pédicures

- » Bolsa 2 u
- » pedicure



50 u.m.vta 50 box

REF.00846

- » 2 unités
- » En silicone

- » Bolsa 2 u
- » De silicone

1 u.m.vta 12 box

REF.06755

**Râpes électriques anti-callosité**
Raspadores de calosidades

1 u.m.vta 24 box

Cette Râpe électrique anti-callosité est un dispositif innovant créé pour adoucir la peau sèche et rugueuse et les callosités sur les pieds. Son rouleau tourne à 360° à une vitesse de 40 tours par seconde. Plus rapide et plus sûr que les râpes électriques conventionnelles. Cette Râpe électrique est conçue pour adoucir la peau épaisse sur les pieds et les talons.

Este raspador de calos é um dispositivo inovador criado para suavizar a pele seca e os calos dos pés. O seu cilindro gira a 360°, a uma velocidade de 40 vezes por segundo. É mais rápido e mais seguro que os raspadores de calos convencionais. Foi concebido para suavizar a pele dura dos pés e dos calcanhars.

REF. 04810

**Recharge**
Recarga**Sachet de 2 limes**
Saco com 2 limas

REF. RE04810/01

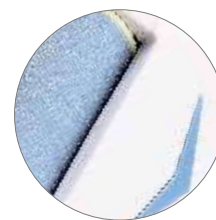

Crème pour les pieds TASSEL
*Crema pés TASSEL*1
u.m.vta12
box» Hydratant Intensif
» *Hidratante intensivo*

400 ml

REF.06430

**Pieds exfoliants TASSEL**
*Esfoliantes pés TASSEL*1
u.m.vta12
box» Au noyau d'abricot
» *Com semente de damasco*

400 ml

REF.06431

**Adoucisseur liquide pour les cors et les callosités**
*Amaciador líquido de durezas e calos*1
u.m.vta12
box

Grâce au adoucisseur liquide Pollié, il est plus facile d'éliminer les callosités et les cors pour obtenir des pieds jeunes et bien entretenus.

Graças ao líquido amaciador Pollié é mais fácil retirar os calos e as durezas para ostentar uns pés jovens e cuidados. .

500 ml

REF.04811



Grandes limes de pédicure
Raspa-calos pedicura

» Plastique
» Plástico

REF.06033

REF.06034



» Métal
» Metálico



REF.01068

Limes transparentes en plastique, rigides et résistantes. pour enlever les callosités.
Lime en céramique à double face



REF.04416

Raspa-calos transparente de plástico rígido e resistente. Lima de cerâmica de dupla face



» Plastique
» Raspa-calos pedicura



REF.04592



REF.01073



limes de pédicure métallique avec poignée en caoutchouc soft
Raspa-calos pedicure metálica com punho de borracha macia

» Blanc
» Branco

REF.06606/58

» Rose
» Rosa

REF.06606/70

**limes de pédicure PODORAPE Deux faces LAVABLE**
Raspa-calos pedicure podorape FACE DUPLA LAVÁVEL

Popadora blanc, bleu et rose double face, solide et doux, lavable avec une poignée incassable, conçue pour les podologues, ultra résistante et idéale pour les diabétiques en raison de l'efficacité et de la sécurité du grain.

Popadora branco, azul e rosa dupla face, um punho forte e macio, lavável com inquebrável, projetado para pedicura, ultra resistente e ideal para diabéticos por causa da eficácia e segurança do grão.

» Blanc
» Branco

REF.06611/58

» Bleu
» Azul



REF.06611/59

» Rose
» Rosa

REF.06611/70

**Râpe-callosités pédicure**
Raspa calosidades pedicure

» Matériau : acier inoxydable
» avec poignée métallique

REF.06709

» Material: aço inoxidável
» Com punho metálico

**50 Papiers abrasifs râpe-callosités**
50 Recargas raspa calosidades

80

REF.06710

180

REF.06711

Pierre ponce
Pedra pomes» Noire
» Cor preta

REF. 06518

» Banche
» Branca

REF. 06517

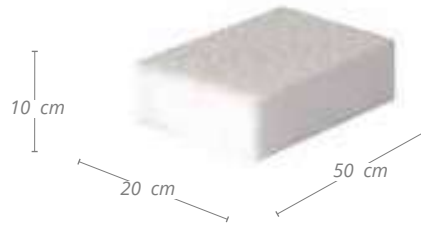
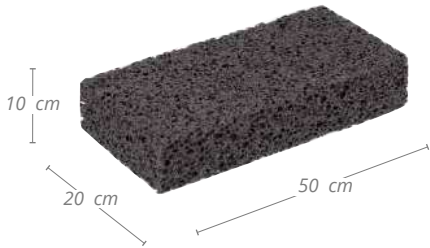
» Grande ponce colorée
» Colorida grande

REF. 00942

» Couleurs assorties
» Cores sortidas

REF. 02757

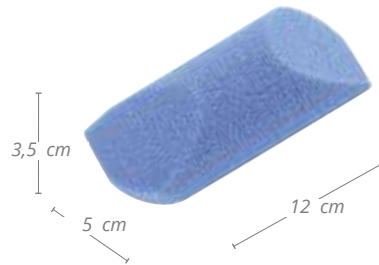
**Pierre ponce avec corde**
Pedra pomes com laço

REF. 03061



REF. 03062

» Poisson
» Pés

REF. 03063

» Ovale
» Ovalada

REF. 03065



Coupe-cors
Corta calos

- » Avec lame incluse
- » Corta calos com lâmina incluída



REF.01102

- » Avec manche en plastique et sans lame
- » Mango plástico sem lâmina



REF.01400

- » En acier inoxydable et sans lame
- » metálico inox. sem lâmina



REF.01401

**Distributeur de lames de Coupe-cors anti-callosités pollié**
Dispensador lâminas corta calos pollié

Lames de rechange en acier pour couteaux. Surface plate et très fine. Des feuilles de qualité garantissant une coupe sûre pour éliminer les callosités excessives et / ou la dureté des pieds, grâce à sa lame de précision, à ses deux faces et à ses arêtes de coupe fines. Ils s'adaptent à tous les coupe-cors standard.

Lâminas de substituição de aço para cortadores. De superfície plana e muito fina. Folhas de qualidade com garantia de corte seguro para eliminar excesso de calos e / ou dureza nos pés, graças a sua lâmina de precisão, bordas de dois lados e cortes finos. Se adaptam a todos os cortadores standard.

- » Boîte de mesures de 100ud: 13cm x 7cm x 1cm
- » Poids: 72gr
- » Feuille de mesures: 2,24cm x 0,01cm
- » "Made in Germany"

- » Mede caixa de 100ud: 13cm x 7cm x 1cm
- » Peso: 72gr
- » Folha de medidas: 2,24cm x 0,01cm
- » "Made in Germany"



72 gr

REF.06459



2,24 cm

AQUATHERM: 3 EN 1
AQUATHERM: 3 EM 1

REF. 02309

- » Puissance: 390W
- » 3 en 1: massage par vibration et bulles avec chaleur infrarouge.
- » Chauffage à eau réglable de 20 °C à 48 °C
- » Minuterie: 20/30/40/50/60 minutes.
- » L'heure et la température sont affichées sur l'écran de l'eau.
- » Fonctions automatiques de lumière infrarouge et chaleur.
- » Rouleaux de massage pour masser la partie interne des pieds.
- » Grilles d'aération ergonomiques.
- » Rouleaux de massage de base amovibles.
- » Boîtier externe double épaisseur pour garder la chaleur.
- » Réflexologie plantaire intense.
- » Pour les pieds jusqu'à la taille 46
- » Dimensions: 38,6 x 24,3 x 45,9 cm



- » Potência: 390W
- » 3 em 1: massagem por vibração e borbulhas com calor infravermelho.
- » Aquecimento da água regulável desde os 20°C aos 48°C.
- » Temporizador: 20/30/40/50/60 minutos.
- » O Display mostra o tempo e a temperatura da água.
- » Funções automáticas de luz infravermelha e de calor.
- » Rolos de massagem para massajarem a parte interna dos pés.
- » Saídas de ar ergonomicamente posicionadas.
- » Rolos de massagem desmontáveis da base.
- » Parte exterior duplamente reforçada para manter o calor.
- » Reflexologia podal intensa.
- » Para pés até ao tamanho 46
- » Medidas: 38,6 x 24,3 x 45,9 cm

**Reflexologie massage**
Massagem de reflexologia

REF. 04588

- » Puissance: 60W
- » Masseur pour les pieds relaxant
- » 3 en 1: chauffage de l'eau, bulles et vibrations
- » Réflexologie plantaire intense, massage inclus
- » Avec drain pour faciliter la vidange
- » Convient aux pieds jusqu'à la taille 44. Anti-dérapant
- » Fonction de chauffage automatique
- » Longueur du câble de connexion 175 cm



- » Potência: 60W
- » Massajador relaxante de pés
- » 3 em 1: aquecimento de água, borbulhas e vibração
- » Intensa reflexologia podal, com massagem incluída
- » Com saída de a água para facilitar o esvaziamento
- » Adequado para pés até ao tamanho 44. Antiderrapante
- » Função de calor automática
- » Cabo elétrico de 175 cm



Reflexologie massage

Massagem de reflexologia



REF. 04809

- » Baignoire de massage pour pieds SPA
- » Puissance: 60W
- » Avec cadran de fonction
- » Massage vibrant et à bulles
- » Semelle de massage de réflexologie en caoutchouc antidérapant

- » *Massajador de pés Spa*
- » *Potência: 60W*
- » *Com botão de função*
- » *Massagem vibratória e de borbulhas*
- » *Base de borracha antiderrapante*

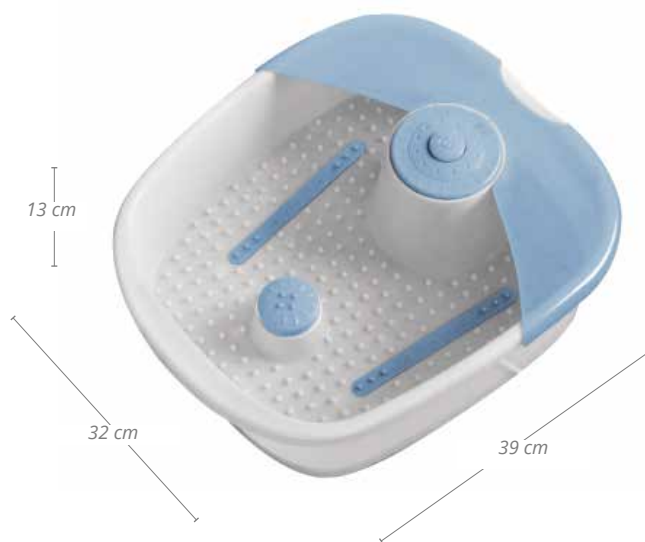

Housse de protection

Proteção massajador

- » Sachet de 100 housses de protection en polyéthylène de haute densité pour baignoires de pédicure
- » Mesures: 48cm de large x45 long, côté pliable + 15cm. Hygiénique.
- » Évitez tout contact entre les pieds du client et la baignoire.
- » Polyéthylène transparent.
- » Une seule utilisation. Jetable

- » *Pacote de 100 unidades de sacos protetores de polietileno de alta densidade para massajadores de pés.*
- » *Medidas: 48cm de largura x 45 cm de comprimento, laterais desdobráveis +15cm, Higiénico.*
- » *Evita o contato dos pés do cliente com o massajador.*
- » *Polietileno transparente. Descartável.*



REF. 06109



05 *Polliá*

Maquillage

MAQUIAGEM

*Crayons, eye-liners, mascara,
éponges de maquillage et de maquillage,
pinceaux et pinceaux...*

*Lápis, delineadores, rímel, maquiagem e
esponjas de maquiagem, escovas e pincéis...*



Crayons POLLIÉ WATERPROOF
Lápis POLLIÉ WATERPROOF

- » Corps en plastique
- » Formule crémeuse qui adoucit et facilite l'application

- » Corpo de plástico
- » Fórmula cremosa que suaviza e facilita a aplicação

Blanc · Branco

REF.03788



Noir · Cor preto

REF.03787

Bleu · Azul

REF.03790



Vert · Verde

REF.03789

Brun · Castanho

REF.03792



Gris · Cinzento

REF.03791

Brun · Castanho

REF.03794



Brun clair · Castanho claro

REF.03795

Rouge · Vermelho

REF.03796



Violet clair · Violeta claro

REF.03797

Marron foncé · Castanho escuro

REF.03798



Violet foncé · Roxo escuro

REF.03799

Rose · Rosa

REF.03800



Crayons cosmétique POLLié BOIS
Lápis POLLié MADEIRA



Testé ophtalmologiquement
 Testado oftalmologicamente

Crayon pour les yeux Khol pour une utilisation sur la ligne des yeux intérieurs et extérieurs. Sa texture crémeuse est douce pour la ligne interne sensible et pour la zone délicate des yeux.

Lápis delineador Khol para uso na linha interna e externa dos olhos. Sua textura cremosa é suave para a linha interna sensível e para a delicada área dos olhos.

Crayon mince en bois extrudé. Application dans la ligne de l'oeil interne et externe
 Lápis fino de madeira extrudido. Aplicação na linha do olho interno e externo

REF.06398



Noir Khol · Cor preto Khol



12,5 cm

Sa forte concentration en pigments rend la couleur résistante et durable dans le lacrymal.
 Sua alta concentração de pigmentos faz com que a cor seja resistente e durável nas lacrimais.

REF.06399



Noir · Cor preto



12,5 cm

REF.06400

REF.06402



Brum · Castanho



12,5 cm



Blanc · Branco



12,5 cm

REF.06403

REF.06404



Vert · Verde



12,5 cm



Gris · Cinzento



12,5 cm

REF.06405

REF.06456



Bleu · Azul



12,5 cm



Lilas · Lilás



12,5 cm

Crayons cosmétique POLLIÉ BOIS
Lápis POLLIÉ MADEIRA



Crayon mince en bois extrudé. Application sur le contour des lèvres et des lèvres
 Crayon à lèvres intense pour définir les lèvres en un seul coup. Il est appliqué agréablement et crémeux et est facile à appliquer avec un pinceau. Texture riche et couleur intense qui vous permet d'essayer la nouvelle façon de porter le crayon à lèvres dans une couleur mate

*Lápis fino de madeira. Aplicação no contorno dos lábios
 Intenso para definir os lábios de uma só vez. Aplica-se agradavelmente e cremoso e é fácil aplicar-se.
 Textura rica e cores intensas que permitem que experimente a nova maneira de usar o delineador em uma cor fosca.*

REF.06406



Brun clair
 Castanho claro



REF.06407



Vin
 Vinho



REF.06408



Brun moyen
 Castanho médio



REF.06409



Rouge foncé
 Vermelho escuro

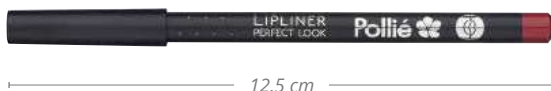

REF.06410



Rose
 Rosa



Crayons cosmétique sourcil POLLIÉ bois
Lápis sobancelha POLLIÉ madeira

Testé ophtalmologiquement
 Oftalmologicamente testado



Crayon mince en bois extrudé. Application sur les sourcils

Crayon à sourcils à la texture mélangable à sec pour définir, colorer et combler le sourcil de manière parfaite avec des traits de couleur doux. Utilisez le capuchon de la brosse pour peigner les sourcils avant l'application et même pour mélanger la couleur appliquée. Finition naturelle qui dure des heures.

Lápis fino de madeira. Aplicação nas sobancelhas

Lápis de sobancelha com textura mista seca para definir, colorir e encher a sobancelha de uma forma perfeita com pinceladas de cores suaves. Use a tampa da escova para pentear a sobancelha antes da aplicação e até mesmo para misturar a cor aplicada. natural que dura horas.

REF.06396



Marron foncé
 Marron escuro

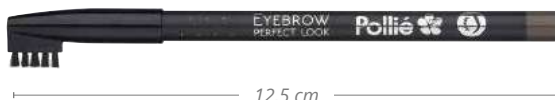

12,5 cm

REF.06397



Brun clair
 Castanho claro

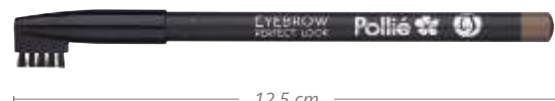

12,5 cm

REF.06455



Noir
 Cor preto

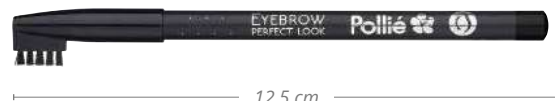

12,5 cm

Présentoir pour crayons pour les yeux, à sourcils ou à lèvres
Expositor de lápis de olhos, sobancelhas e lábios



» 16 compartiments
 » 16 compartimentos

REF.06807

» Vide
 » Vazio

REF.06807/01



Mascara pour recourber les cils
Máscara de pestanas

Testé ophtalmologiquement
 Oftalmologicamente testado



Glamglam volume et intensité
Volume e intensidade glamglam

REF.06826

Intensifier intense noir
Intensificador intenso preto

REF.06827

Etanche
 4D Volume
 Avec des cires naturelles

Impermeável
 Volume 4D
 Com ceras naturais



Test dermatologique
 Cires naturelles
 X3 noir

Teste dermatológico
 Ceras naturais
 X3 preto



Éponge cellulosose pour démaquiller

Esponja desmaquiagem celulose

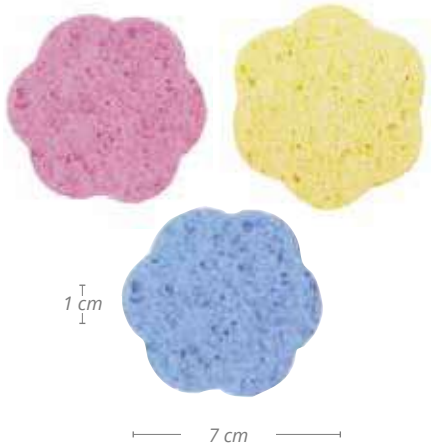

12
u.m.vta

360
box

● ● ●

REF.01355

REF.01355/77

Vrac
A granel

REF.01355/59/01

12
u.m.vta

2160
box

REF.01355/70/01

REF.01355/77/01

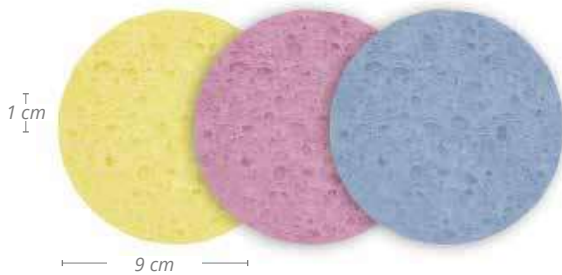

12
u.m.vta

240
box

● ● ●

REF.01938

REF.01938/77

Vrac
A granel

REF.01938/59/01

1080
u.m.vta

1080
box

REF.01938/70/01

REF.01938/77/01

Éponge naturelle

Esponja natural

» Éponge naturelle pour le bain
» *Esponja natural banho*

1
u.m.vta

16
box

REF.02478

» Éponge naturelle de maquillage, de texture douce, adaptée aux peaux sensibles et délicates. Hypoallergénique.

1
u.m.vta

72
box

REF.02453

» *Esponja natural desmaquiagem, de textura suave, indicada para peles sensíveis e delicadas. Hipóalergénica.*



Sachet de 2 éponges plates minces pour enlever le maquillage Pacote 2 esponjas planas finas desmaquiagem

Quand elles sèchent, elles durcissent, empêchant ainsi la formation de germes.
Quando secam endurecem, impedindo assim a formação de germes.

Humide
Húmidas



12 u.m.vta 240 box

REF.03166



12 u.m.vta 180 box

REF.03165

Sachet à serviette-éponge fine pour démaquiller Bolsa toalha esponja fina desmaquiagem

12 u.m.vta 180 box

REF.03168

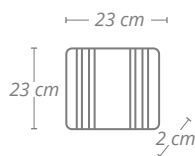

Éponge non latex - polyuréthane Esponja não latex - poliuretano

1 u.m.vta 15 box



Elle peut être utilisée sèche ou mouillée. Pour une utilisation à sec, elle est recommandée pour l'application du maquillage en poudre tel que les poudres compactes, fards à joues, ombres à paupières... Pour une utilisation humide, elle sert à appliquer les fonds de teint, crèmes, lotions et autres produits de maquillage liquides.

Pode utilizar a esponja molhada ou seca. Para utilização em seco, é adequada para aplicar maquiagem em pó como, pós compactos, blush, sombras... Para utilizar húmida, é boa para aplicar bases, cremes, loções e outros produtos de maquiagem líquidos.

NEW

REF.07128



NEW

REF.07127



Sachet de 2 éponges cylindriques pour maquillage
Pacote 2 esponjas cilíndrica maquiagem

12
u.m.vta

180
box

REF.03167

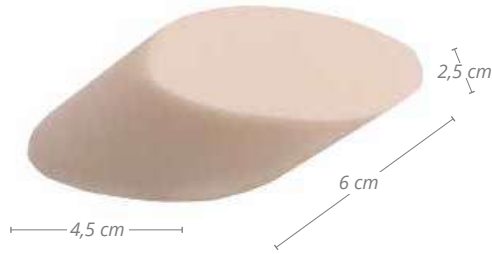

Éponge de maquillage
Esponja maquiagem

1
u.m.vta

12
box

REF.03559

» Set de 4 éponges de maquillage roses

12
u.m.vta

240
box

REF.01361

» Esponja maquiagem rosa set-4

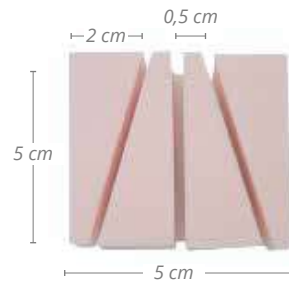

» Latex NBR
 » Látex NBR

12
u.m.vta

360
box

REF.01356

» Latex NBR
 » Látex NBR

12
u.m.vta

240
box

REF.02898

» Latex NBR
 » Látex NBR

12
u.m.vta

240
box

REF.02897



Éponge maquillage latex NBR

Esponja maquiagem látex NBR

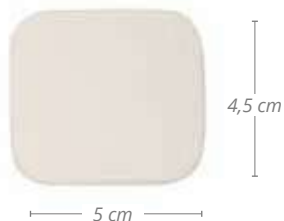

12
u.m.vta

360
box

REF.01409



12
u.m.vta

240
box

REF.02899

Sachet de 2 éponges de maquillage latex

Pacote 2 esponjas maquiagem látex



REF.01410



12
u.m.vta

360
box

REF.01357

Éponges maquillage

Esponjas maquiagem

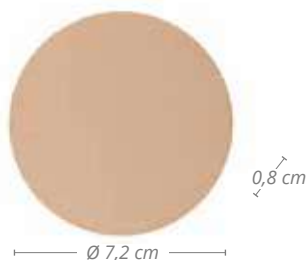

12
u.m.vta

360
box

REF.01354

» 4 unités
» 4 unidades

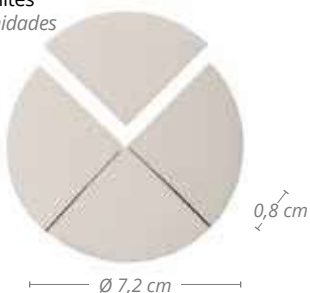

12
u.m.vta

12
box

REF.01358

» Sachet de 4 éponges maquillage
» en forme de coeur
» Pacote 4 esponjas maquiagem corações

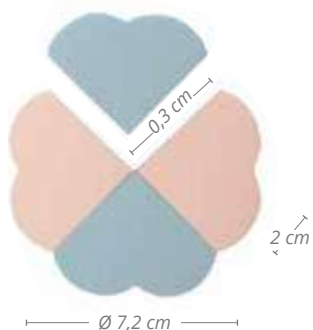

12
u.m.vta

240
box

REF.02675

» Sachet de 12 éponges en latex
» Pacote 12 esponjas de látex

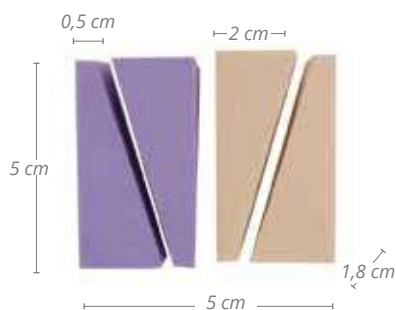

12
u.m.vta

12
box

REF.01459

Sachet éponges maquillage couleurs ASSORTIES

Pacote esponjas maquiagem diferentes cores

» 8 éponges
» 8 esponjas



REF.01481



» 24 éponges
» 24 esponjas



REF.02671



» 4 éponges
» 4 esponjas



REF.02672



» 3 éponges
maquillage
+ 2 glands



REF.02673

» 3 esponjas
maquiagem
+ 2 borlas

» 6 éponges
» 6 esponjas



REF.02674



» 33 éponges
» 33 esponjas



REF.02676



Houppette maquillage

Esponja maquiagem

» Rose
» Rosa



REF.01360



Ø 61

» Moyen
» Média



REF.01411



Ø 70

» Grande
» Grande



REF.01359



Ø 85

Pinceau blush ANGLED
Pincel para blush ANGLED

REF.07416



NEW

Pinceau blush
Pincel de blush

REF.07408



NEW

Pinceau mélangeur
Pincel de mistura

REF.07418



NEW

Pinceau mélangeur
Pincel de mistura

REF.07419



NEW

Pinceau mélangeur
Pincel de mistura

REF.07420



NEW



Brosse de maquillage pollié: manche en plastique, poils synthétiques
Pincel de maquiagem pollié: punho de plástico, cerdas sintéticas



- » **RÉSULTATS PROFESSIONNELS:** Pinceaux de maquillage professionnels faits de soies synthétiques de première qualité pour une application précise, lisse et sans égratignures. Chouchoutez votre peau avec des pinceaux de maquillage doux, faciles à entretenir et sans cruauté envers les animaux.
- » **POLYVALENT:** Comprend une large gamme de brosses ovales pour une utilisation avec tous les produits tels que; comptage, base, correction des cernes, poussière ...
- » **POIGNÉE DES BROSSES FLEXIBLES:** Les poignées des brosses ont été conçues pour se plier afin d'offrir une application facile du maquillage dans les zones difficiles d'accès.
- » **APPLICATION DOUCE ET PRÉCISE:** Les poils souples de haute qualité assurent que les produits tels que les fondations, les correcteurs liquides, les crèmes BB, les fards et les poudres peuvent être appliqués uniformément et doucement.

- » **RESULTADOS PROFISSIONAIS:** Pincéis de maquiagem profissional feitos de cerdas sintéticas premium para aplicação, suave e sem riscos. Mime a sua pele com pincéis suaves de maquiagem, fáceis de manter e livre de crueldade contra os animais.
- » **MULTIFUNCIONAL:** Inclui uma ampla gama de escovas ovais para uso com todos os produtos, como; countorning, base, correção de olheiras, poeira ...
- » **PUNHO DOS PINCEIS FLEXÍVEIS:** Os punhos dos pincéis foram projetados para dobrar, a fim de oferecer uma fácil aplicação de maquiagem em áreas de difícil acesso.
- » **APLICAÇÃO SUAVE:** As cerdas de alta qualidade garantem que produtos como fundações, corretores líquidos, cremes BB, blushes possam ser aplicados uniformemente e suavemente.

» Rond grande

» Rodada grande



REF.06059

» Rond moyen

» Rodada médio



REF.06060

» Ovale grande

» Oval grande



REF.06061

» Oval petite

» Oval pequeno



REF.06062

» Rond mini

» Rodada mini



REF.06063

» Set de 5 pinceaux

» Set 5 pincéis



REF.06064

Pinceau à paupières
Pincel de sombra



N°7

REF.07393

NEW



N°6

REF.07394

N°5

REF.07395



N°4

REF.07396

N°3

REF.07397



N°2

REF.07398

N°1

REF.07399



Pinceau eye-liner
Pincel eyeliner



REF.07400



NEW

Pinceau mélangeur eyeliner
Pincel De Mistura De Delineador



REF.07401



NEW

Pinceau de guérison / flou
Pincel de cura / desfoque



REF.07402

N°5

NEW



N°4

REF.07403

N°3

REF.07404



N°2

REF.07405

N°1

REF.07406



Ombres de nez de brosse de contour
Sombras de contorno em escova de contorno



REF.07407



NEW

Pinceau correcteur de maquillage
Pincel corretivo de maquiagem



REF.07409



NEW

Pinceau à lèvres rétractable
Pincel de lábios retrátil



REF.07410



NEW

Brosse de mélange de sourcils
Pincel para misturar sobrancelha



REF.07411



NEW

Brosse peigne à sourcils
Pincel pente para sobrancelha



REF.07417



NEW



Pinceau FOUNDATION
Pincel FOUNDATION

NEW



REF.07413

N°4

REF.07412

N°3



N°2

REF.07414

N°1

REF.07415





Pinceaux professionnel KABUKI

Pincéis profissional KABUKI

Les pinceaux Kabuki sont considérés comme les meilleurs pour l'application du maquillage, des ombres à paupières ou du rouge. L'utilisation de ceux-ci, procure une sensation de douceur extrême comme une caresse sur la peau du client et permet une finition parfaite. Ils sont indispensables pour un professionnel de maquillage.

Os pincéis Kabuki são considerados os melhores para a aplicação da maquiagem, as sombras de olhos ou o gloss. A utilização destes, confere uma sensação de suavidade extrema como uma carícia na pele do cliente e permite um acabamento de estrela de cinema. São indispensáveis para um profissional da maquiagem.

Brosse KABUKI

Pincéis KABUKI

Synthétique
Sintético



» Conique
» Cónico

REF.04094

» Angle
» Ângulo

REF.04095



» Rond
» Redondo

REF.04096

» Plat
» Plano

REF.04097



» Conique d'ombre à paupières
» Sombra cónico

REF.04111

» Conique d'ombre à paupières
» Sombra cónico

REF.04098



» Angle d'ombre à paupières
» Sombra ângulo

REF.04099

» Plat d'ombre à paupières
» Sombra plano

REF.04101



Pinceau brosse Kabuki
Pincel Kabuki
Synthétique
Sintético1
u.m.vta12
box

REF.04703

- » Rond
- » Rodada



- » Oblique
- » Obliquo

REF.04704



- » Émoussé
- » Contundente

REF.04705

Synthétique
Sintético1
u.m.vta12
box

- » Rond
- » Redondo

REF.04100



- » Avec éponge en latex
- » Esponja látex

REF.04102



- » Conique
- » Cónico pequeno

REF.04112



- » Rond
- » Redondo

REF.04113



- » Étroit
- » Estreito

REF.04114



- » Plat droit
- » Plano reto

REF.04115



Brosse de maquillage Escovas de maquiagem



» Pinceau à poudre
» Pincel de pó

REF.07390

» Pinceau contour /
coloret
» Pincel de contorno /
coloret

REF.07391

» Pinceau surligneur
» Pincel iluminador

REF.07392



Pinceau brosse cosmétique et pinceaux de maquillage KABUKI Escovas de maquiagem e escova cosmética KABUKI



» Pinceau de maquillage poils naturels
» Diamètre des cheveux: 27,5 mm
» Emballage: sac plastique individuel
» Idéal pour transporter sans prendre de place

» Pincel de maquiagem pêlo sintético/Taklon
» Diâmetro do cabelo: 27,5 mm
» Embalagem: Saco plástico individual
» Ideal para transportar sem ocupar espaço

REF.03561



Pinceau brosse cosmétique et pinceaux de maquillage KABUKI Pincel de maquiagem e escova cosmética KABUKI

» Brosse
cosmétique
sachet inclus
manche en
plastique
» Poils de chèvre

» Pincel cosmética
bolso, punho de
plástico
» Cerdas de cabra



REF.01812

» Brosse de maquillage en poil naturel
» Diamètre des cheveux: 27,5 mm
» Emballage: sac plastique individuel
» Idéal pour transporter sans prendre de place



REF.03560

» Pincel de maquiagem cerdas natural
» Diâmetro do cabelo: 27,5 mm
» Embalagem: Saco plástico individual
» Ideal para transportar sem ocupar espaço





Pinceaux manche en bois Pincéis cabo madeira

- » Pinceau nuance
- » Poils de chèvre

REF.02884

- » Pinceau matizer
- » Poils de chèvre

REF.02885

- » Pincel colorir
- » Cerdas de cabra

- » Pincel matizador
- » Cerdas de cabra



- » Pinceau diffuseur
- » Poils d'écreuil

REF.02886

- » Pinceau d'ombre
- » Poils d'écreuil

REF.02887

- » Pincel esfumado
- » Cerdas de esquila

- » Pincel sombra
- » Cerdas de esquila



- » Pinceau pour les yeux
- » Poils de marte

REF.02888

- » Pinceau d'ombre
- » Poils de marte

REF.02889

- » Pincel olhos
- » Cerdas de marta

- » Pincel sombra
- » Cerdas de marta



- » Pour les yeux
- » Poils de marte

REF.02890

- » À lèvres
- » Poils de marte

REF.02891

- » Para olhos
- » Cerdas de marta

- » Lábios
- » Cerdas de marta



- » À lèvres
- » Poils de marte

REF.02892

- » Ayant éponge en latex
- » Esponja látex

REF.02893

- » Lábios
- » Cerdas de marta



- » Pinceau masque
- » Poils de nylon

REF.02894

- » Pinceau en poil de sanglier
- » Pinceau peigne
- » Mascara pour recourber les cils

REF.02895

- » Pincel máscara
- » Cerdas de nylon

- » Pincel javali
- » Pente profissional máscara



Pinceaux manche en bois

Pincéis punho de madeira



- » Brosse cosmétique à base de matériau de matage
- » Poils de chèvre

» *Pincel cosmética matizadora brush*
 » *Cerdas de cabra*



REF.01814

- » Brosse cosmétique blush
- » Poils de chèvre

» *Pincel cosmética colorir*
 » *Cerdas de cabra*



REF.01815

- » Brosse éponge cosmétique
- » *Pincel cosmética esponja*



REF.01816

- » Brosse cosmétique pour les yeux
- » Poils de marte

» *Pincel cosmética olhos*



REF.01817

- » Brosse (pinceau) cosmétique d'ombre
- » Poils de chèvre + poney

» *Pincel cosmética sombra*
 » *Cerdas de cabra + pony*



REF.01818

- » Pinceau cosmétique de lèvres
- » Poils de chèvre + poney

» *Pincel cosmética lábios*
 » *Cerdas de cabra + pony*



REF.01819

- » Brosse (pinceau) cosmétique d'ombre
- » Poils de chèvre + poney

» *Pincel cosmética sombra*
 » *Cerdas de cabra + pony*



REF.01821

- » Pinceau brosse / peigne Cils et Sourcils
- » Poils de sanglier

» *Pincel pente máscara*
 » *Cerdas de javali*



REF.01820

Idéal maquillage fluide

Maquiagem fluida ideal

Synthétique
Sintético

- » Mache en plastique
- » *Punho de plástico*



REF.04511

- » Mache en bois
- » *Punho madeira*



REF.04512

Pinceaux brosse manche en bois
Pincéis punho de madeira



REF.01800

- » Pinceau nuance
- » Poils de chèvre

- » *Pincel matizador*
- » *Cerdas de cabra*



- » Pinceau blush
- » Poils de chèvre

- » *Pincel colorir*
- » *Cerdas de cabra*



REF.01801

- » Pinceau masque
- » Poils de cochon

- » *Pincel máscara*
- » *Cerdas de porca*



REF.01802

- » Pinceau maquillage ventilateur
- » Poils de chèvre

- » *Pincel leque*
- » *Cerdas de cabra*



REF.01803

- » Pinceau yeux
- » Poils de marte

- » *Pincel olhos*
- » *Cerdas de marta*



REF.01804

- » Pinceau à lèvres
- » Poils de marte

- » *Pincel lábios*
- » *Cerdas de marta*



REF.01805

- » Pinceau ombre
- » Poils de chèvre + poney

- » *Pincel sombra*
- » *Cerdas de cabra + pony*



REF.01806

- » Pinceau d'ombre
- » Poils de chèvre + poney

- » *Pincel sombra*
- » *Cerdas de cabra + pony*



REF.01807

- » Pinceau éponge latex
- » *Pincel esponja latex*



REF.01808

- » Pinceau masque
- » Nylon

- » *Pincel máscara*
- » *Nylon*



REF.01809

- » Pinceau-peigne mascara
- » Poils de sanglier

- » *Máscara escova-pincel*
- » *Cerdas de javali*



REF.01810

Présentoir 66 pinceaux cosmétiques
Expositor 66 pincéis cosmética



REF.01466



01800



01804



01801



01805



01802



01806



01803



01807



01808



01809



01810

Pour plus d'informations sur les pinceaux, voir page 695
 Para mais informação sobre os pincéis consultar página 695

Pinceaux 12 unités**Pincéis 12 units**

» Double éponge
» Dupla esponja

12 u.m.vta
12 box

» Pinceau /éponge
» Pincel/esponja

12 u.m.vta
12 box

REF.01508

REF.01509

**Taille-crayon**
Afiador

» Normal/ épais
» Normal/grossa

12 u.m.vta
120 box

» Taille-crayon double
cosmétique
» Afiador duplo cosmética

12 u.m.vta
72 box

REF.01067

REF.06364

**Sachet d'applicateurs d'ombre**
Bolsa aplicadores sombra

12 u.m.vta
120 box

» Couleurs
» Cor es

12 u.m.vta
120 box

» Couleurs
» Cor es

12 u.m.vta
120 box

5 u

REF.01505

5 u

REF.01507

12 u

REF.01506



Nettoyant à la silicone pour les pinceaux de maquillage
Limpador de silicone para pincéis de maquiagem

1
u.m.vta

12
box

REF.04706



Étui rond de 7 pinceaux maquillage avec miroir
Estojo redondo 7 pincéis maquiagem com espelho

1
u.m.vta

6
box

REF.03562



Set de 12 pinceaux
Set 12 pincéis cosmética



» Contient: 02884, 02885, 02886, 02887, 02889, 02890, 02891, 02892, 02893, 02894, 02895.

» Contém: : 02884, 02885, 02886, 02887, 02889, 02890, 02891, 02892, 02893, 02894, 02895.

REF. 02896

Pour plus d'informations sur les pinceaux, reportez-vous 673

Para mais informação sobre os pincéis consultar página 673



Étui de 7 pinceaux de maquillage en poils synthétiques
Estojo 7 pincéis maquiagem pêlo sintético



REF.03563



Étui de pinceaux cosmétiques (VIDE)
Estojo pincéis cosmética (VAZIO)



REF.03564



Set de 5 pinceaux
Set 5 pincéis



REF.02585



Faux-cils

PESTANAS

*Faux cils complets, faux-cils individuels,
faux cils adhésifs, sourcils...*

*Pestanas completos, pestanas individuais,
pestanas adesivos, sobrancelhas...*



Faux cils POLLIÉ individuels Pestañas POLLIÉ individuais

1
u.m.vta

50
box



Faux-cils individuels en quatre étapes

1. Nettoyer vos cils naturels et vos paupières afin qu'il ne reste aucune trace de maquillage, ni d'impuretés.
2. Retirer les faux-cils de la boîte avec les pinces Pollié (red 06562).
3. Appliquer une goutte de colle sur le papier métallique et imbiber la base du faux-cil avec la colle.
4. Placer l'extension sur le cil naturel proche de la ligne des cils SANS TOUCHER la paupière. Appliquer autant de cils que souhaité afin d'obtenir le résultat désiré.

Comment retirer vos faux-cils Pollié?

Imprégner deux cotons avec le dissolvant à faux-cils Pollié. Placer un coton sous les faux-cils et l'autre dessus. Frotter délicatement jusqu'à ce que se décolent les faux-cils.

Pestañas individual em 4 passos

1. Limpe as suas pestanas naturais e as pálpebras para que estejam sem maquilhagem e impurezas.
2. Extraia as pestanas da caixa com as pinças Pollié (ref 06562).
3. Aplique uma gota de adesivo no papel metálico e ensopie a base da pestana com o adesivo.
4. Coloque a extensão sobre a pestana natural perto da linha das pestanas SEM TOCAR na pálpebra. Aplicar tantas pestanas quanto desejar para conseguir o resultado desejado.

Como retirar as pestanas Pollié?

Embeber dois algodões com o removedor de pestanas Pollié. Colocar um algodão debaixo das pestanas e outro por cima. Esfregue-os suavemente até que as pestanas descolem.

» Courts
» Noir



REF.06508

» Moyens
» Noir



REF.06509

» Curto
» Cor preto

» Mídia
» Cor preto

» Longs
» Noir



REF.06510

» Mixte
» Noir



REF.06511

» Long
» Black

» Misturado
» Cor preto

» Courts
» Duo



REF.06512

» Moyens
» Duo



REF.06513

» Curto
» Duo

» Mídia
» Duo

» Long
» Noir



REF.06514

» Courts
» Trio



REF.06515

» Longo
» Cor preto

» Curto
» Trio

» Moyens
» Trio



REF.06516

» Longs
» Trio



REF.06519

» Mídia
» Trio

» Longo
» Trio

Faux-cils POLLIÉ noirs 100% naturels
Pestañas POLLIÉ cor preto 100% natural

1 u.m.vta 50 box



Faux-cils complets en 4 étapes

Adaptation des faux cils à la taille correcte: Aligner les faux-cils avec votre ligne naturelle de cils et couper l'excès.
 Application de la colle: Appliquer une fine ligne de colle tout le long de la bande et attendre 20-30 secondes. En cas d'excès de colle, utiliser du lait démaquillant pour éliminer les surplus.

Pose des faux cils: Placer les faux-cils avec colle sur la ligne naturelle de vos cils et appuyer légèrement jusqu'à les fixer.

Retouche finale: Utiliser les pinces Pollié (ref 06314) pour ajuster les faux-cils de sorte qu'ils soient bien alignés et fixés.

Comment retirer vos faux-cils Pollié?

Décoller la bande de faux-cils en commençant par le coin externe. Placer les cils dans leur boîte pour les réutiliser dans le futur.

Pestañas completas em 4 passos

Adaptar as pestanas à medida correcta: Alinhar as pestanas com a sua linha natural de pestanas e recortar no caso de excesso.

2Aplicação do adesivo: Aplicar uma linha fina de adesivo ao longo da tira e esperar 20-30 segundos. No caso de ter excesso de adesivo, utilize desmaquilhante para eliminar a parte que sobra.

Aplicação das pestanas: Coloque as pestanas com adesivo em cima da linha natural, pressionando ligeiramente até as fixar.

Retoque final: Utilizar as pinças Pollié (ref 06314) para ajustar as pestanas de forma a que fiquem bem alinhadas e fixas.

Como retirar as suas pestanas Pollié?

Desprender a tira de pestanas começando pelo extremo exterior. Coloque as pestanas na sua Caixa para voltar a utilizá-las num futuro

N°1



REF.06487

N°2



REF.06488

N°3



REF.06489

N°4



REF.06490

N°5



REF.06491

N°6



REF.06492

N°7



REF.06493

N°8



REF.06494

N°9



REF.06495

N°10



REF.06496

Faux-cils POLLIÉ noirs 100% naturels Pestañas POLLIÉ cor preto 100% natural

1 u.m.vta
50 box



Faux-cils complets en 4 étapes

Adaptation des faux cils à la taille correcte: Aligner les faux-cils avec votre ligne naturelle de cils et couper l'excès.
Application de la colle: Appliquer une fine ligne de colle tout le long de la bande et attendre 20-30 secondes. En cas d'excès de colle, utiliser du lait démaquillant pour éliminer les surplus.

Pose des faux cils: Placer les faux-cils avec colle sur la ligne naturelle de vos cils et appuyer légèrement jusqu'à les fixer.

Retouche finale: Utiliser les pinces Pollié (ref 06314) pour ajuster les faux-cils de sorte qu'ils soient bien alignés et fixés.

Comment retirer vos faux-cils Pollié?

Décoller la bande de faux-cils en commençant par le coin externe. Placer les cils dans leur boîte pour les réutiliser dans le futur.

Pestañas completas em 4 passos

Adaptar as pestanas à medida correcta: Alinhar as pestanas com a sua linha natural de pestanas e recortar no caso de excesso.

2Aplicação do adesivo: Aplicar uma linha fina de adesivo ao longo da tira e esperar 20-30 segundos. No caso de ter excesso de adesivo, utilize desmaquilhante para eliminar a parte que sobra.

Aplicação das pestanas: Coloque as pestanas com adesivo em cima da linha natural, pressionando ligeiramente até as fixar.

Retoque final: Utilizar as pinças Pollié (ref 06314) para ajustar as pestanas de forma a que fiquem bem alinhadas e fixas.

Como retirar as suas pestanas Pollié?

Desprender a tira de pestanas começando pelo extremo exterior. Coloque as pestanas na sua Caixa para voltar a utilizá-las num futuro

N°11



REF.06497

N°12



REF.06498

N°13



REF.06499

N°14



REF.06500

N°15



REF.06502

N°16



REF.06503

N°17



REF.06504

N°18



REF.06505

N°19



REF.06506

N°20



REF.06507

Set 3 pinces individuelles cil par cil
Conjunto 3 pinças individuais cerdas ao cerdas

1
u.m.vta

12
box

Ensemble de 3 clips pour le placement des faux-cils et extensions de cils. Étui métallique inclus.
 Conjunto de 3 cliques para colocação de cílios e extensões de cílios. Com um estojo de metal

REF.06562



**QUELLE FORME DE YEUX AVEZ-VOUS?**

Déterminer la forme des yeux est la première étape pour décider quel style de cils est convenable

YEUX ROUNDS

Faux cils classiques, mélange de courts et de longs qui adoucissent le regard: réf 02700, 02693, 02695, 04079

YEUX EN AMANDE

Faux cils denses et plus fins vers les pointes: Réf 02690, 02691, 02698, 02699, 02701..

YEUX ENFONCÉS OU PETITS

Faux Cils à faible densité et longs pour ouvrir le regard: réf 02696, 02697, 02692, 02694.

**QUE FORMA TEM O SEU OLHO?**

Determinar a forma dos olhos é o primeiro passo para decidir que estilo de pestanas é adequado para si.

OLHOS REDONDOS

Pestanas clássicas, mistura de curtas e largas suavizam o olhar: Ref. 02700, 02693, 02695, 04079.

OLHOS AMENDOADOS

Pestanas densas e mais finas até às pontas: Ref. 02690, 02691, 02698, 02699, 02701

OLHOS FUNDOS OU PEQUENOS

Pestanas pouco numerosas e largas para abrir o olhar: Ref. 02696, 02697, 02692, 02694..

Comment utiliser?**Como usar****FAUX-CILS COMPLETS****PESTANA COMPLETA**

1. Prenez la mesure avec vos yeux et coupez l'excès.
2. Appliquez une fine ligne d'adhésif le long de la bande. Attendez 30 secondes pour ajuster.
3. A l'aide d'une paire de pincettes, placez sur la paupière à la naissance des cils.
4. Maquiller et vous êtes fin prêt!

1. Tomar a medida do seu olho e cortar o excedente.
2. Aplique uma linha delgada de adesivo ao longo da banda. Esperar 30 seg. para ajustar.
3. Com ajuda dum par de pinças colocar sobre a pálpebra na raiz das pestanas.
4. Maquilhar e está pronto!

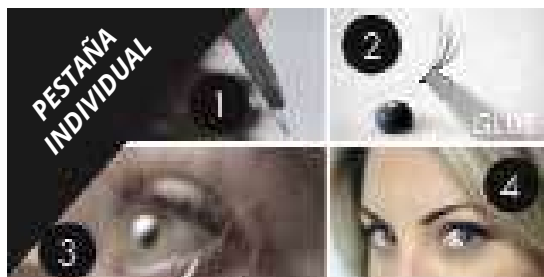
**Faux-cils individuel:****Pestana individual:**

1. Prenez un faux cil avec pincettes.
2. Mouiller la base en adhésif
3. Placez à la naissance des cils. Jamais sur la paupière.
4. Maquiller et vous êtes fin prêt!

1. Pegue a pestana com umas pinças.
2. Molhar a base ao adesivo
3. Colocar na raiz das pestanas. Nunca na pálpebra.
4. Maquilhar e está pronto!

Avoir un look naturel et sophistiqué
Para um look natural e sofisticado



Faux-cils magnétiques ANDREA
Pestañas magnéticas ANDREA

1 u.m.vta
72 box

- » Facile à appliquer, pas besoin d'adhésif, réutilisable
- » Technologie à aimants multiples permettant aux cils de s'installer parfaitement sur votre ligne de cils naturels
- » Bande pré-incurvée profilée pour s'adapter à la paupière
- » Les cils restent bien placés jusqu'à ce que vous décidiez de les enlever
- » Composé d'une languette supérieure et d'une languette inférieure pour obtenir un puissant effet à double volume
- » Ils ne nécessitent pas d'adhésif et sont réutilisables

- » Fácil de aplicar, sem necessidade de adesivo, reutilizável
- » Tecnologia de ímã múltiplo para pestanas para aplicar perfeitamente em sua linha de cílios naturais
- » Faixa pré-curvada contornada para encaixar a pálpebra
- » Os cílios permanecem bem colocados até que você decida removê-los
- » Composto por uma aba superior e uma aba inferior para alcançar um poderoso efeito de duplo volume
- » Não necessitam adesivo e são reutilizáveis

- » Double 21
- » Duplas 21

REF.06445

- » Double 45
- » Duplas 45

REF.06446



Pinces pour faux-cils
Pinças para pestanas postiças

1 u.m.vta
12 box

Aident à placer les faux-cils
Ajuda a colocar as pestanas

REF.06314



Faux-cils Andrea SM
Pestanas Andrea SM» 62 noir
» 62 cor preto

REF.02700

» 70 noir
» 70 cor preto

REF.02701

» 21 noir
» 21 cor preto

REF.02690

» 21 marron
» 21 castanho

REF.02691

» 23 noir
» 23 cor preto

REF.02692

» 26 noir
» 26 cor preto

REF.02693

» 28 noir
» 28 cor preto

REF.02694

» 33 noir
» 33 cor preto

REF.02695

» 45 noir
» 45 cor preto

REF.02696

» 45 marron
» 45 castanho

REF.02697

» 53 noir
» 53 cor preto

REF.02698

» 53 marron
» 53 castanho

REF.02699

Faux cils complets auto-adhésifs de couleur noire
Pestanas completas auto adhesivas pretas cor preto

4 u.m.vta
72 box

» 33 noir
» 33 cor preto



REF.03670

» 21 noir
» 21 cor preto



REF.03672

» 45 noir
» 45 cor preto



REF.03673

» 53 noir
» 53 cor preto



REF.03671

Faux cils complets
Pestanas completas

4 u.m.vta
72 box

» 52 noir
» 52 cor preto



REF.04841

» 33 marron
» 33 castanho



REF.04079

» 80 noir
» 80 cor preto



REF.04842

» 82 noir
» 82 cor preto



REF.04843

» 19 noir
» 19 cor preto



REF.04844

» Mod Accents
» 318 noir
» 318 pretas
» "Accents"



REF.04846

» Mod . Accents
» 301 noir

» 301 pretar
» "Accents"



REF.04554

» Mod . Accents
» 305 noir

» 305 pretas
» "Accents"



REF.04555

Faux-cils complets lashlites 335 de couleur noire
Pestanas completas lashlites 335 cor preto

4
u.m.vta

72
box

REF.04845



Kit de faux-cils andrea
Kit pestanas andrea

4
u.m.vta

36
box

REF.02704

» Starter 45
 » Starter 45



Faux-cils en touffes sans noeuds
pestanas sem nós

4
u.m.vta

72
box

REF.04553

» Largas
 » Long



» Starter 53
 » Starter 53



REF.02703

» Moyens
 » Médias

REF.04552



» Starter 33
 » Starter 33



REF.02702

» Courts
 » Curto

REF.04551



Avant · Antes

Alors · Então



Faux-Cils individuels Permalash
Pestanas individuais PESTANAS Permalash

4 u.m.vta
72 box

» Moyens, de couleur marron SM

» Médias, castanho SM



REF.02708

» Combo de couleur noire

» Largas cor preto



REF.03278

» Moyens, de couleur noire SM

» Cor preto, médias



REF.02707

» Larges de couleur noire

» Largas cor preto



REF.04078

» Petite taille et de couleur noire

» pequenas, cor preto SM



REF.02705

» Petite taille et de couleur marron

» Pequenas, castanhas SM



REF.02706

» Moyens poil à poil de couleur noire

» Médias pêlo a pêlo cor preto



REF.03277

» Avec la technique poil à poil, de couleur noire

» Curtas pêlo a pêlo. Cor preto



REF.03276

Kit de Cils individuels combo de couleur noire
Kit pestanas individuais combo cor preto

4 u.m.vta
36 box

REF.04077



Présentoir de faux Cils Andrea Expositor pestanas Andrea

1 u.m.vta 1 box



Présentoir rotatif
Expositor giratório

REF.03203

Il contient 8 unités de chaque:

- » Onglets complets: 02690, 02691, 02693, 02695, 92696, 02698, 02700, 02701.
- » Cils complets adhésifs: 02711 (clair), 02712 (foncé)
- » Cils individuels: 02705, 02706, 2707, 02708, 03278
- » Onglets individuels adhésifs: 02713 (light), 03066 (dark)
- » Cils individuels dissolvants adhésifs: 03204

Contém 8 unidades de cada:

- » Abas completas: 02690, 02691, 02693, 02695, 92696, 02698, 02700, 02701.
- » Pestañas cheias adesivas: 02711 (claro), 02712 (escuro)
- » Cílios individuais: 02705, 02706, 2707, 02708, 03278
- » Guias individuais adesivas: 02713 (claro), 03066 (escuro)
- » Cílios individuais com solvente adesivo: 03204



Adhésif pour faux Cils INDIVIDUELS Adesivo Pestañas INDIVIDUAIS

6 u.m.vta 72 box

- » Andrea Permalash
- » Couleur claire: transparente



3,5 gr

REF.02713

- » Andrea Permalash
- » Claro: transparent

- » Andrea Permalash
- » De couleur foncée



3,5 gr

REF.03066

Dissolvant d'adhésif à faux cils INDIVIDUELS Dissolvente adesivo pestanas INDIVIDUAIS

6 u.m.vta 72 box



7 gr

REF.03204

1 u.m.vta 1 box

18 codes x 8 sous blister
18 códigos x 8 blisters

REF.04200

Adhésif pour faux Cils COMPLETS Adesivo Pestañas COMPLETAS

6 u.m.vta 72 box

- » Andrea Permalash de couleur claire: Transparente



7 gr

REF.02711

- » Andrea Permalash claro: transparent

- » Andrea Modlash **oscuro**



7 gr

REF.02712

- » Andrea Modlash **dark**

1 u.m.vta 1 box

Présentoir de faux Cils
Andrea VIDE

Expositor pestanas
Andrea VAZIO

REF.03335



Recourbe-cils
Enrolador de pestanas



REF.01109



Recourbe-cils en caoutchouc de rechange
Recarga borracha modelador de pestanas



2 u

REF.01110



3 Rasoirs à sourcils polié
3 Navalhas polié para sobrancelhas



Rasoir pour sourcils, duvet du visage et duvet du corps. Il est conseillé d'appliquer du gel ou de la crème sur la zone à raser pour que la coupe soit plus douce et agréable. Le manche est en ABS et la lame en acier inoxydable de haute qualité.

Lâmina para sobrancelhas, penugem facial e pelos corporais. É aconselhável aplicar gel ou creme na zona que se deseja barbear, para que seja um corte mais suave e cómodo. O cabo é fabricado em ABS, enquanto a folha é fabricada em aço inoxidável de elevada qualidade.

NEW

REF.07125



13 cm



NEW

REF.07126



15 cm



Les sourcils andrea
Sobrancelhas andrea1 u.m.vta
24 box» 3 en 1
crème brune
moyenne» 3 em 1 creme
castanho
médio

REF.06286

» 3 en 1 crème
brune foncé» 3 em 1 creme
castanho escuro

REF.06285

» Powder duo
brune
moyenne» Powder duo
castanho
médio

REF.06287

» Powder duo
brune foncé» Powder duo
castanho escuro

REF.06288

» Pencil duo
brune
moyenne» Pencil duo
castanho
médio

REF.06290

» Pencil duo
brune foncé» Pencil duo
castanho
escuro

REF.06289

Pack 3 lames de sourcils
Embalar 3 lâminas de sobrancelha

REF.06291

Gel fixateur transparent
Gel fixador transparente1 u.m.vta
24 box

REF.06292

07

Hygiène et jetables esthétique

ACESSORIOS
E HIGIENE

*Drap pour table de massage, serviettes,
couvertures, miroirs, vêtement...
Capas marquesa, tolas, espelhos,
malas..*



Sac 10 housses ajustables pour table massage Bolsa 10 covers marquesa ajustável



REF.07308

30 gr

- » Matériel: Nonwoven
- » Dimensions: 210cm x 80 cm
- » Bête 100 unités de couverture de civière réglable
- » 1 unité/sachet
- » Poids: 40gr.

- » Material: Nonwoven
- » Medidas: 210 cm x 80 cm
- » Caixa de 100 unidades de maca ajustável
- » Apresentado em bolsa individual
- » Peso: 40gr.

NEW



Papier pour table massage Rolo papel marquesa



43 gr

- » Rouleau de papier pour table esthétique
- » Longueur: 78m / largeur: 59 cm
- » Poids du papier: 43g.
- » 40 services marqués et prédécoupés, d'une longueur de 1,95 m chacun.

- » Comp: 78m/largura:59 cm
- » Gramagem do papel: 43g.
- » 40 serviços marcados e pré-cortados, de 1,95 m de largura cada um.
- » Os rolos estão embalados individualmente.

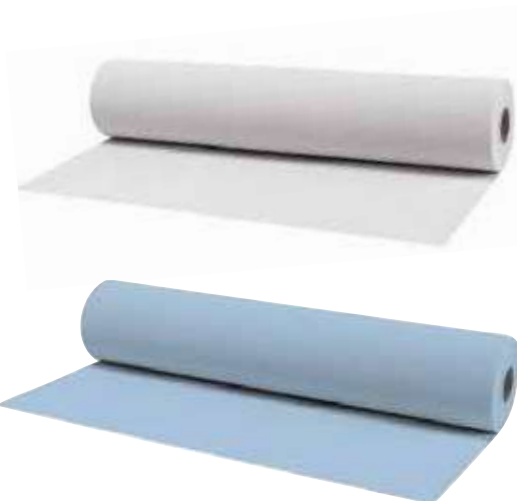

REF. 00928

REF.00928/75

Couverture pour table massage ajustable Cover marquesa ajustável



43 gr

- » Matériel: Nonwoven
- » Dimensions: 210cm x 80 cm
- » Bête 100 unités de couverture de civière réglable
- » 1 unité/sachet
- » Poids: 40gr.

- » Material: Nonwoven
- » Medidas: 210 cm x 80 cm
- » Caixa de 100 unidades de maca ajustável
- » Apresentado em bolsa individual
- » Peso: 40gr.



REF. 03336

Couverture chauffante pour table esthétique
Manta elétrica para marquesa1 u.m.vta
4 box

90 gr

REF. 06273

- » Puissance: 60W
- » Trois niveaux de température
- » Indicateur de température par LED.
- » NE PAS LAVER
- » Couverture au toucher doux et confortable
- » Mesures: 150 x 60 cm
- » Tension: 230V ~
- » Fréquence: 50/60 Hz

- » Potência: 60W
- » Tres níveis de temperatura
- » Indicador de temperatura por leds
- » NÃO LAVAR
- » Confortável e suave ao tato
- » Medidas: 150 x 60 cm
- » Tensão: 230V ~
- » Frequência: 50/60 Hz

**30 couvertures pour transpiration**
30 lençóis de transpiração1 u.m.vta
10 box

REF. 03912

Housse stretcher blanc tergal
Proteção elástica branca1 u.m.vta
12 box

REF. 06650

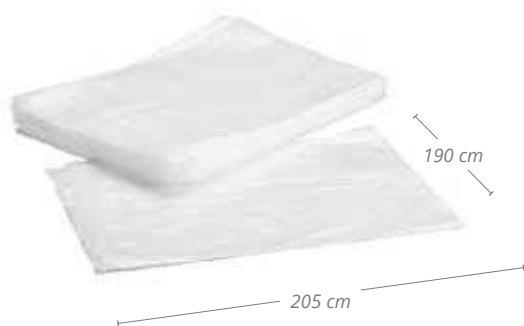
**Drap de table massage plastifié**
Capas marquesa plastificada1 u.m.vta
100 box

REF. 03695

- » Cape de table esthétique plastifiée pour les traitements.
- » Réglable.
- » Emballée individuellement.

- » Capa marquesa plastificada para tratamentos
- » Ajustável.
- » Embaladas individualmente

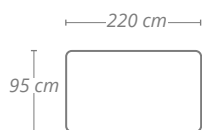
**Sachet de 20 draps pour table massage**
Pacote 20 capas marquesa1 u.m.vta
22 box

REF. 03248

- » Non réglables de type drap
- » Não ajustável tipo lençol

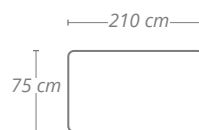

Sachet 75 serviettes CELLULOSE

Pacote 75 toalhas CELULOSE

- » Spéciales manucure
- » Especial manicure

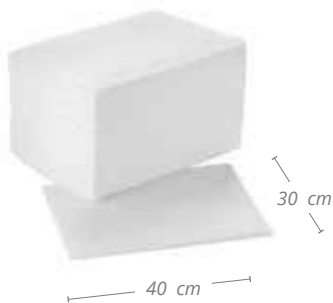
50 gr/m²

REF. 04204

Sachet de 25 serviettes SPUNLANCE

Pacote 25 toalhas SPUNLANCE

- » Plié à 20 x 20 cm
- » 50% Polyester / 50% viscose
- » Dobrado a 20 x 20 cm
- » 50% poliéster / 50% Viscose



24 box

50 gr/m²

40 x 90 cm

REF. 04916

28 box

50 gr/m²

40 x 80 cm

REF. 03221

Sachet 90 Serviettes CELLULOSE

Pacote 90 Toalhas CELULOSE

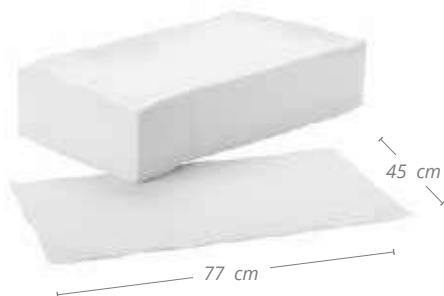
55 gr/m²

REF.04076

Sachet 100 Serviettes SPUNLANCE

Pacote 100 toalhas SPUNLANCE

- » Super absorbantes
- » Superabsorventes.



REF. 03283

Sachet 200 serviettes CELLULOSE

Bolsa 200 toalhas CELULOSE

50 gr/m²

REF.06664

Sachet de 35 serviettes SPUNLANCE

Pacote 35 toalhas SPUNLANCE

- » Super absorbantes.
- » Serviettes pliées

- » Superabsorventes
- » Toalhas dobradas.

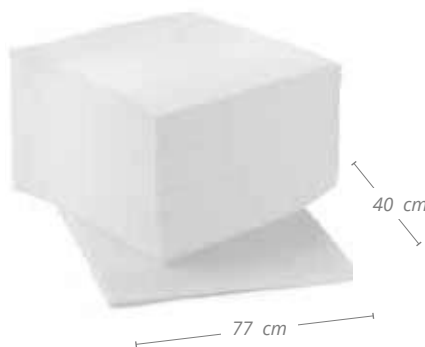
50 gr/m²

REF. 04509

Sachet de 100 serviettes SPUNLACE
Bolsa 100 toalhas SPUNLACE

- » Serviettes pliées
- » Manucure spéciale

» Toalhas dobradas
» Especial manicure



REF. 07302

- » Serviettes pliées
- » Manucure spéciale

» Toalhas dobradas
» Especial manicure

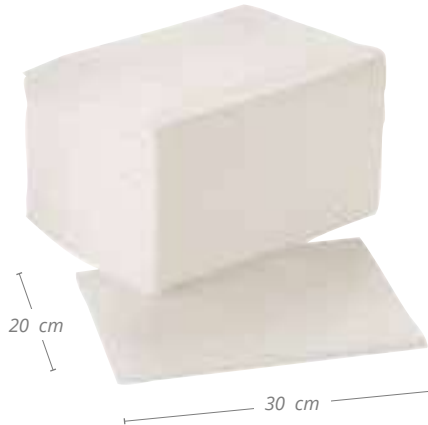

REF. 07303

**Sachet de 75 serviettes SPUNLACE**
Bolsa 75 toalhas SPUNLACE

- » Super absorbantes
- » Serviettes pliées
- » Manucure spéciale

» Superabsorventes
» Toalhas dobradas
» Especial manicure



REF. 04510

**Protecteurs - pantalons**
Protetores - calças

Sachet contenant 25 unités de pantalons de protection en polyéthylène de haute densité pour des traitements esthétiques tels que la pressothérapie ou des traitements en cabine avec des algues ou des boues.

Bolsa 25 unidades calças protetoras polietileno de alta densidade para tratamentos estéticos como pressoterapia ou tratamentos em cabine com algas ou lamas.



REF. 06111



100 Gants en polyéthylène transparent

100 Luvas transparentes de polietileno



- » 100% Polyéthylène vierge pehd 0,7 +/- 2% g / pc
- » Hypoallergénique, étanche, taille unique
- » EPI catégorie 1
- » Fabriqué et marqué CE, compatible avec l'usage alimentaire 2011/10 / CE
- » 30 Cm. Hauteur x 25 cm. Largeur des doigts x 15 cm. Largeur du poignet

- » Polietileno hdpe 100% 0,7 +/- 2% g / pc
- » Analérgico, impermeável, um tamanho,
- » Categoria 1 EPI
- » Produtos e marcações CE, compatível com uso de alimentos 2011/10 / CE
- » 30 Cm de altura x 25 cm de largura x 15 largura do pulso 15



NEW

REF. 07804



Sachet de 100 gants jetables

Saco de 100 luvas descartáveis



REF. 07304



NEW



Boîte 100 gants jetables

100 luvas descartáveis



REF. 07257

- » Gants ambidextres, qui servent pour les deux mains
- » Taille unique
- » Multi-usages
- » Matière: plastique
- » 80g
- » Boîte dispensatrice

- » Ambidestro permite que cada luva seja usada para qualquer mão
- » Tamanho único
- » Multiuso
- » 80g
- » Material: plástico
- » Caixa dispensadora



NEW



Sachet de 2 unités. Gants professionnels

Bolsa 2 u. luvas profissionais



- » Matériel: caoutchouc
- » Material: rubber

6,5
Talla / Tamanho

REF.01672

7
Talla / Tamanho

REF.01673

7,5
Talla / Tamanho

REF.01674

8
Talla / Tamanho

REF.01675

Boîte 50 gants synthétiques Caixa 50 luvas látex pretas



PAS de poussière
SEM pó

- » Combinent la flexibilité du latex et l'élasticité du vinyle inodore.
- » Sensation de seconde peau grâce aux propriétés élastiques très similaires au latex et aux propriétés hypoallergéniques du vinyle.
- » Matière : dérivé du PVC.
- » Non stériles.
- » Couleur noire.
- » Surfaces interne et externe lisses
- » Aptes pour allergiques au latex

- » Combina a flexibilidade do látex e a elasticidade do vinil inodoro
- » Segunda sensação na pele graças às suas propriedades elásticas muito semelhantes ao látex e oferece as propriedades hipoalergênicas do vinil.
- » Material: derivado de PVC.
- » Não estéril
- » Cor preta
- » Superfícies lisas internas e externas
- » Adequado para pessoas alérgicas ao látex

NEW



M

REF. 07263

L

REF. 07264

Boîte contenant 100 gants blancs en latex légèrement poudrés Caixa 100 luvas látex brancas com pouco pó

LATEX / LATEX
AQL 1,5

S/M

REF. 01671

S/M

REF. 01669

S/M

REF. 01670

Boîte contenant 20 gants noirs en latex Caixa 20 luvas látex pretas



NON poudrés
SEM pó

LATEX / LATEX
AQL 1,5

S

REF. 02832

M

REF. 02833

L

REF. 02834

Boîte contenant 100 gants vinyle Caixa 100 luvas vinil



NON poudrés
SEM pó

VINYLE / VINYL
AQL 1,5

S

REF. 02586

M

REF.02587

L

REF. 02588

Pince en acier inoxydable
Aço inoxidável, utensílios de uso geral

1 u.m.vta 12 box

REF.04556



Serviette 100% coton
Toalha 100% algodão

12 u.m.vta 48 box

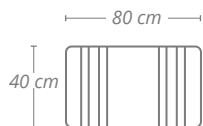

380 gr

REF. 02947/58

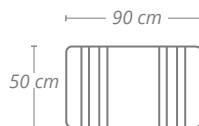

380 gr

REF. 02901/58



Serviette de manucure
Toalha manicure

12 u.m.vta 12 box

REF.00974

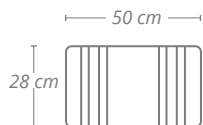

Serviette 100% coton
Toalha 100% algodão

1 u.m.vta 24 box

TASSEL
LINE ESTHETIQUE

1 u.m.vta 48 box

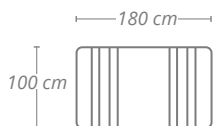

300 gr

REF. 06570/58

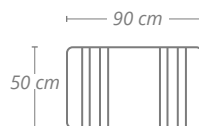

300 gr

REF. 06571/58



Brosse tout usage, couleurs
Escova multi-usos, cores

24 u.m.vta 24 box

REF. 00129



Brosse vêtements et ski
Escova roupa e tapeçaria

1 u.m.vta 20 box

» Caoutchouc bleue
» Borracha azul

REF.00893



Draps de protection

Lençóis protetores



REF. 06112

REF. 06110



Polyéthylène haute densité 25 unités.
180 x 200 cm. Pour les traitements d'algues et de boue.

Polietileno de alta densidade 25 unidades.
180 x 200 cm. Para tratamentos de algas e lama

Draps de protection polyéthylène haute densité 50 unités.
180 x 200 cm. Pour les traitements d'algues et de boue.

Lençóis protetores polietileno de alta densidade 50 unidades.
180 x 200 cm. Para tratamentos de algas e lama

Balance spa mesure l'hydratation et le % de graisse corporelle

Balança spa mede a hidratação e a % de gordura corporal



REF. 04805

- » Capacité: 150 kg
- » Échelle: 6 à 150 kg
- » Unité de pondération: kg / lb /st
- » Deux piles CR2032 (Incluses)
- » Vitesse de pesée: vitesse moyenne (env. deux secondes)
- » Arrêt automatique: 10 secondes
- » Lorsque la pile est faible, l'écran affiche « LO »

- » Capacidade: 150 kg
- » Escala: 6 a 150 kg
- » Unidade de ponderação: kg / lb /st
- » Duas pilhas CR2032 (Incluídas)
- » Velocidade de pesagem: velocidade média (aprox. dois segundos)
- » Desliga automaticamente: 10 segundos
- » Quando estiver a ficar sem pilhas marcará no ecrã "LO".



Sac de 50 tapis pour solarium

Bolsa 50 tapetes solarium



REF.03803



Ø 35 cm

Kimono jetable
Kimono descartável

- » Dimensions : 104x140 cm.
- » Matière : tissu non tissé
- » La ceinture se trouve dans une poche du bras gauche

- » Medidas: 104 x 140 cm.
- » Material: non woven (tecido sem tecer)
- » Leva o cinto num bolso do braço esquerdo

**NEW**

35 gr

REF. 07307/58

**NEW**

35 gr

REF. 07307/50

Sac 100 couvre-chaussures
Embalagem 100 cobre-sapatos

- » À usage unique
- » Plastique
- » Uma só utilização
- » Plástico

**NEW**

REF. 07211



Sac de 100 paires de pantoufles avec semelle en caoutchouc**Bolsa de 100 pars des Sapatilhas sola borracha**100
u.m.vta100
box» Ouverte
» Abertas

REF.02919

» Fermées
» Fechadas

REF.02920

**Sac de 50 paires de pantoufles****Bolsa de 50 pars des Sapatilhas**1
u.m.vta10
box» Ouvertes
» jetable

REF.03807

» Fermées
» jetable

REF.03808

» Abertas
» Utilização única» Fechadas
» Utilização única**Sachet de 12 paires de claquettes matelassées****Bolsa com 12 pares de chinelos almofadados**1
u.m.vta16
box

REF. 06661

**Paire de deux claquettes pédicure****Par de dois chinelos de pedicure**» Couleurs variées
» Sortido cores1
u.m.vta12
box

REF. 06776

**Sachet de 12 paires de claquettes pédicure****Bolsa com 12 pares de chinelos de pedicure**1
u.m.vta480
box

REF. 07432



NEW

Sachet de 100 charlottes
Bolsa 100 coifas

- » Jetable
- » Pliés de type accordéon

- » Utilização única
- » Pregadas tipo acordeão

14 gr/m²

REF.07305

Boîte de 100 bandeaux blancs
Caixa 100 diademas brancos

- » Jetable
- » Utilização única



REF.07306



Rouleau de papier crêpé
Rolo papel crepado

- » Pour bandeaux
- » 100 services
- » Spécial esthétique.

- » Para diademas
- » 100 utilizações
- » Especial estética



REF.04420



Boîte de 50 strings pour homme
Caixa 50 tangas homem

REF.03216

- » Jetable. Une taille unique
- » Élastique et ajustable
- » Couleur noire opaque
- » Idéal comme complément pour l'épilation et le traitement

- » Utilização única. Tamanho único
- » Elástico para adaptar-se a qualquer medida
- » Cor preto opaco
- » Ideal como complemento para depilação e tratamento

Boîte de 50 slips pour homme
Caixa 50 slíps homem

REF.03295

- » Jetable. Une taille unique
- » Élastique et ajustable
- » Couleur noire opaque
- » Idéal comme complément pour l'épilation et le traitement
- » Utilização única. Tamanho único
- » Elástico para adaptar-se a qualquer medida
- » Cor preto opaco
- » Ideal como complemento para depilação e tratamento

Boîte de 100 strings pour femme
Bolsa 100 tangas mulher

REF.03483

- » Élastique ajustable.
- » Jetable

- » Elástico para adaptar-se a qualquer medida. Utilização única

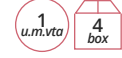
Boîte de 10 boxers pour homme
Bolsa 10 boxers homem

REF.03802

- » Jetable
- » Utilização única

Boîte de 100 strings pour femme
Bolsa 100 tangas mulherstrings

REF.01091

- » Bande arrière très étroite.
- » Jetable

- » Tira traseira muito estreita.
- » Utilização única

Pantalons pressothérapie
Calças pressoterapia

REF.03694

- » Sans élastique
- » Blanc.
- » Jetable

- » Sem elástico
- » Branco.
- » Utilização única



Bandeau esthétique
Diadema esteticien10
u.m.vta100
box

REF. 01088

**Tee shirt TASSEL**
Camiseta TASSEL1
u.m.vta50
box

Chemises pour femmes en coton. Noir, col rond et manches courtes avec logo Tassel sérigraphié sur la poitrine. Disponible en plusieurs tailles. Confortable, facile à combiner avec n'importe quel look. Tissu résistant

Camisas femininas em algodão. Preto, gola redonda e mangas curtas com o logotipo Tassel serigrafado no peito. Disponível em vários tamanhos. Confortável, fácil de combinar com qualquer look. Tecido resistente



M

REF.06284/2

L

REF.06284/3

XL

REF.06284/4

XXL

REF.06284/5

Lunettes de protection antibuée
Tapete desinfetante de calçado1
u.m.vta10
box

REF.07256

- » Protection pour prévenir les infections elles protègent efficacement des éclaboussures, des poussières, etc...
- » Lieu d'utilisation : tous les endroits qui nécessitent une protection des yeux.
- » Design innovant, confortable. Elles s'ajustent parfaitement à toute les formes et tailles de tête.
- » Elles peuvent être utilisées en même temps que des lunettes de vue.
- » Certificat CE
- » Matière : plastique

- » Proteção para prevenir infeções: protegem eficazmente contra salpicos, cascalho, etc.
- » Local de utilização: qualquer lugar onde se requiera proteção para os olhos.
- » Design inovador cómodo. Ajustam-se perfeitamente a qualquer forma e tamanho de cabeça.
- » Podem-se utilizar por cima dos seus óculos graduados.
- » Certificado CE
- » Material: plástico

NEW

**Tapis désinfection pour semelles de chaussures**
Tapete desinfetante de calçado1
u.m.vta12
box

REF.07234

Tapis extra-plat de seulement 1 cm de hauteur pour éviter les chutes, fabriqué en polypropylène sur une base en caoutchouc et un conteneur en aluminium ionisé. Dimensions : 60 cm de largeur x 40 cm de longueur x 1 cm d'épaisseur/hauteur.

Mode d'emploi : placer le tapis sur une surface plane et nivelée, appliquer dans le plateau environ 700 ml de liquide désinfectant. Il est recommandé de placer un paillason après le plateau pour que le client puisse ensuite s'essuyer les pieds.

Tapete extraplano com apenas 1 cm de altura para evitar que alguém tropece em polipropileno sobre uma base de borracha e contendor de alumínio oxidado. Medidas: 60 cm largura x 40 cm profundidade x 1 cm altura/espessura

Como utilizar: colocar o tapete sobre uma superfície plana e nivelada aplicar na bandeja cerca de 700 ml de líquido desinfetante. Aconselhamos colocar um tapete fofoquinho à frente deste tapete para secar o calçado do cliente.

NEW

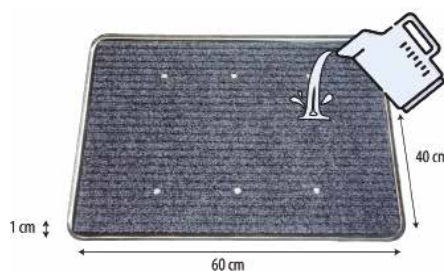

Kg coton de coiffure en rouleaux. 9 Morceaux de 3,5 cm (embouts inclus)
Kg algodão cabeleirero em rolos. 9 Cortes de 3,5 cm (pontas incluídas)

Bouts inclus
Pontas incluídas



REF. 00964



Anónimo
Anonymous

REF. 00964/00

» 4 coupures de 8 cm
» 4 cortes de 8 cm



REF. 04290

» Plié
» Dobrável

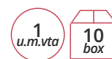

REF. 04288



Sachet de disques pour démaquiller
Bolsa discos desmaquiagem

» 80 disques
» 80 discos



REF. 07118

» Anónimo
» Anonymous



REF. 07118/00



Boîte 200 coton-tige coton avec TIGE EN PAPIER
Caixa 200 cotonetes algodão com PAUZINHO DE PAPEL

NEW



REF.07261



Sachet de coton zigzag pré-découpé
Bolsa algodão zigzag pré-cortado



REF.02949



Miroir chromé rond
Espelho cromado redondo



Ø 10

1 u.m.vta
60 box

5x

REF.06716

1 u.m.vta
60 box

7x

REF.06717

1 u.m.vta
60 box

10x

REF.06718

Ø 15

1 u.m.vta
24 box

5x

REF.06719

1 u.m.vta
24 box

7x

REF.06720

1 u.m.vta
24 box

10x

REF.06721



Ø 18

1 u.m.vta
24 box

5x

REF.06722

1 u.m.vta
24 box

7x

REF.06723

1 u.m.vta
24 box

10x

REF.06724

Miroir chromé rond avec 3 ventouses
Espelho cromado redondo com 3 ventosas



Ø 15

1 u.m.vta
48 box

5x

REF.06725

1 u.m.vta
48 box

7x

REF.06726

1 u.m.vta
24 box

10x

REF.06727

Ø 21

1 u.m.vta
24 box

5x

REF.06728

1 u.m.vta
24 box

7x

REF.06729

1 u.m.vta
24 box

10x

REF.06730



Miroir chromé rond avec support
Espelho cromado redondo com base

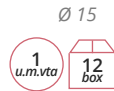

7x

REF.06731



10x

REF.06732



7x

REF.06735



10x

REF.06736



7x

REF.06733



10x

REF.06734



7x

REF.06737



10x

REF.06738

Miroir chromé rond avec pieds et support
Espelho cromado redondo com pé e base



7x

REF.06739



10x

REF.06740



7x

REF.06741



10x

REF.06742

Miroir double face pivotant rond sur un pied en métal grossissant 5X / normal
Espelho pé metálico duplo 5 aumentos/normal

16,5 cm

1 u.m.vta
6 box

5x

REF.02801

19 cm

1 u.m.vta
6 box

5x

REF.02806

16,5 cm

1 u.m.vta
12 box

5x

REF.02799

19 cm

1 u.m.vta
12 box

5x

REF.02800

Miroir à double face
Espelho duplo

- » Avec poignée et support
- » Com cabo e suporte

1 u.m.vta
24 box

REF. 01965



Miroir rond
Espelho redondo

- » Miroir rond professionnel
- » Espelho redondo profissional

1 u.m.vta
8 box

REF. 00294/56



Miroirs Espelhos

» Miroir de sac modèle Capilla

» Espelho bolso modelo Capilla

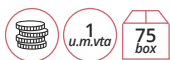

REF. 00265

7 cm



» Miroir rond normal /
augmentation



REF. 00266

» Espelho redondo normal/
aumento



» Miroir poudrier
» normal / augmentation
avec un peigne



REF. 03073

» Espelho pó normal/
aumento com pente



Miroir de sac carré Espelho bolso quadrado



S

REF. 00270



L

REF. 00268



Miroir poudrier normal / grossissant Espelho normal/aumento pó



S

REF.00214



L

REF.00213



Miroir rond Espelho redondo

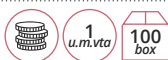

S

REF. 00263



L

REF. 00264

Miroir Espelho

- » Avec poignée
- » Com pega



REF.00250

- » Mousse EVA
- » Avec poignée noire



REF.04742

- » Epuma EVA
- » Com pega preta



Miroir rond Espelho redondo

S

REF. 06620

M

REF. 06621

L

REF. 06622



Miroir de camping
Espelho de camping

12
u.m.vta

12
box

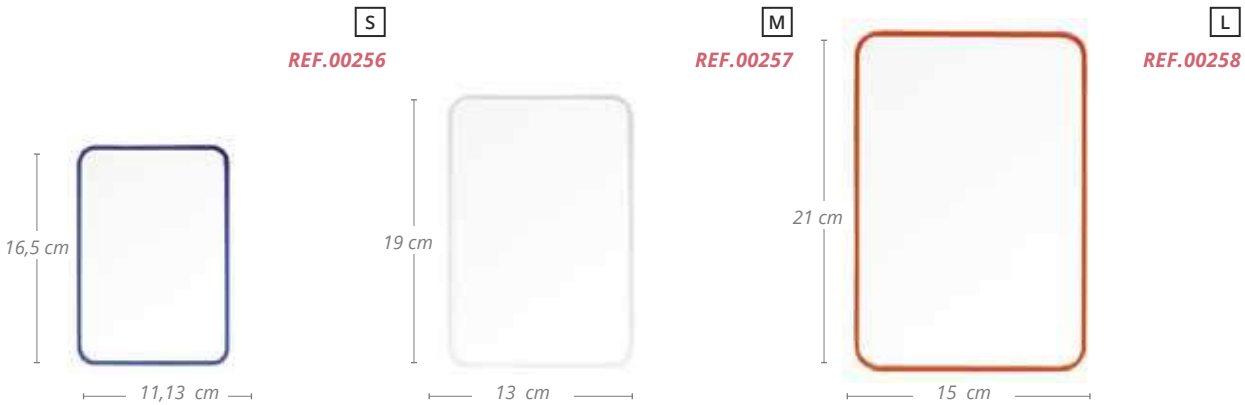

Miroir de camping
Espelho de camping

1
u.m.vta

12
box



Miroir TV
Espelho TV

Stack of mirrors icon

1
u.m.vta

10
box

REF. 00254/50

REF. 00254/58

REF. 00255



Boîte de 50 masques faciaux hygiéniques
Caixa de 50 máscaras faciais higiênicas



REF. 07383

NEW



Masque hygiénique 100% COTON 30 utilisations réutilisable /lavable
Máscara higiênica 100% ALGODÃO 30 utilizações reutilizável / lavável



REF. 07803

- » 30 utilisations
- » LAVABLE: Laver à 60°, sécher et repasser à 140° durant 10-15 secondes pour activer le traitement. Nombre de lavages : 30)

- » 30 utilizações
- » LAVÁVEL: Lavar a 60°, secar e engomar a 140° durante 10-15 segundos para ativar o tratamento. (N.º de lavagens 30)

NEW



Écran de protection visage
Ecrã protetor facial



REF. 07212

ANTIBUÉE
 Plastique transparent avec mousse sur le front pour un meilleur confort

ANTI VAPOR
 Plástico transparente com espuma à frente para uma maior comodidade

NEW

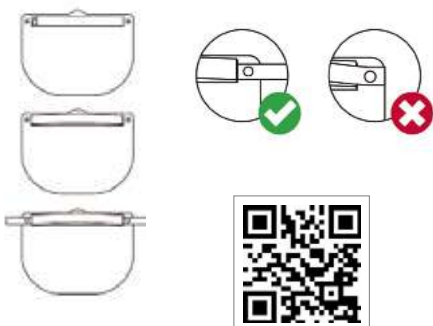

NEW

Masque réutilisable
60 lavages
Máscara reutilizável
60 lavagens

- » Réutilisables
- » Certifiés
- » Waterproof
- » Transpirables
- » Microfibre
- » Équivalence FFP-2
- » LACLA Fabriqué en Espagne

- » Reutilizáveis
- » Certificadas
- » Waterproof
- » Respirável
- » Microfibras
- » Equivalência FFP-2
- » LACLA Made in Spain

Pack 6 masques tissu unis
Packs 6 máscaras têxteis unidades lisas

1 u.m.vta
 20 box

Noir
 Preto

REF. 07309

Rose
 Rosa

REF. 07310

Beige
 Bege

REF. 07318

Blanc
 Branco

REF. 07319



Pack 3 masques tissu imprimés
Packs 3 máscaras têxteis unidades estampadas

1 u.m.vta
 40 box



Papillons
 Borboletas

REF. 07311



Cœurs
 Coração

REF. 07312



Têtes de mort
 Caveiras

REF. 07315



Pois
 Bolinhas

REF. 07314



Militaire
 Militar

REF. 07313

Casaque de coeurs Casaco de copas

* Não disponível em Portugal

1
u.m.vta40
box

MOD. 51605128

Noir
Preta

Casaque à manches courtes, avec pince poitrine et col mao, 1 poche frontale imprimée et une poche colour unie, boutons de couleur, cintrée, fentes latérales.
100 % polyester

Mini jaqueta de manga, com gola de peito e gola mao, 1 bolso frontal com padrão 1 e um simples, abotoado com botões coloridos, equipado com pinças, fendas laterais.
100 % poliéster

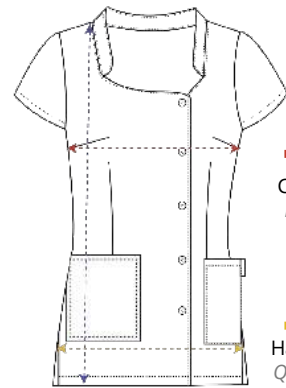
Longueur
LongoCoffre
PeitoHanche
Quadril

S

98 - 102 cm
102 - 106 cm
72 - 74 cm

REF.06297/50/1

M

106 - 110 cm
108 - 112 cm
73 - 75 cm

REF.06297/50/2

L

114 - 118 cm
116 - 120 cm
75 - 77 cm

REF.06297/50/3

XL

120 - 124 cm
124 - 128 cm
77 - 79 cm

REF.06297/50/4

XXL

126 - 130 cm
136 - 140 cm
78 - 80 cm

REF.06297/50/5

MOD. 51605128

Blanc
Branco

Casaque à manches courtes, avec pince poitrine et col mao, 1 poche frontale imprimée et une poche colour unie, boutons de couleur, cintrée, fentes latérales.
100 % polyester

Mini jaqueta de manga, com gola de peito e gola mao, 1 bolso frontal com padrão 1 e um simples, abotoado com botões coloridos, equipado com pinças, fendas laterais.
100 % poliéster

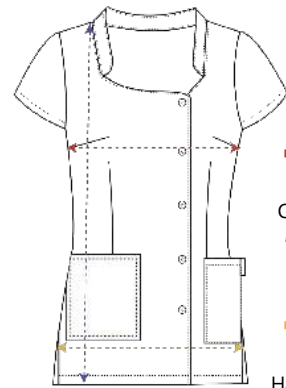
Longueur
LongoCoffre
PeitoHanche
Quadril

S

98 - 102 cm
102 - 106 cm
72 - 74 cm

REF.06297/58/1

M

106 - 110 cm
108 - 112 cm
73 - 75 cm

REF.06297/58/2

L

114 - 118 cm
116 - 120 cm
75 - 77 cm

REF.06297/58/3

XL

120 - 124 cm
124 - 128 cm
77 - 79 cm

REF.06297/58/4

XXL

126 - 130 cm
136 - 140 cm
78 - 80 cm

REF.06297/58/5

Casaque "live silver"

Casaco live silver

* Não disponível em Portugal

1 u.m.vta 40 box

MOD. 51307830

Blanc
Branco

Casaque couleur unie, manches courtes, col mao, ourlet devant couleur argent satiné, avec poches, fermeture latérale avec des crochets métalliques rectangulaires, dos cintré, ouvertures latérales. Facile à repasser Polyester très respirant. 100 % polyester fin

Casaco liso, mangas curtas, gola mao e bainha frontal com cor prateada acetinada, frente com ourelas e bolsos, fecho lateral com braçadeiras retangulares de metal, costas com grampos, aberturas laterais. Fácil de passar Poliéster muito respirável. 100 % poliéster fino

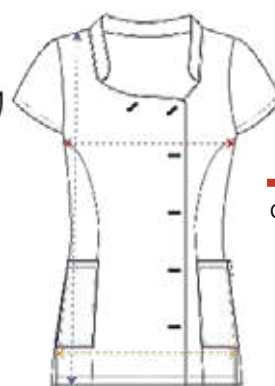

Coffre
Peito

Hanche
Quadril

Longueur
Longo

S

98 - 102 cm
104 - 108 cm
70 - 72 cm

REF.06301/58/1

M

106 - 110 cm
112 - 114 cm
70 - 72 cm

REF.06301/58/2

L

114 - 118 cm
118 - 122 cm
72 - 74 cm

REF.06301/58/3

XL

120 - 124 cm
126 - 130 cm
73 - 75 cm

REF.06301/58/4

MOD. 51307830

Noir
Preta

Casaque couleur unie, manches courtes, col mao, ourlet devant couleur argent satiné, avec poches, fermeture latérale avec des crochets métalliques rectangulaires, dos cintré, ouvertures latérales. Facile à repasser Polyester très respirant. 100 % polyester fin

Casaco liso, mangas curtas, gola mao e bainha frontal com cor prateada acetinada, frente com ourelas e bolsos, fecho lateral com braçadeiras retangulares de metal, costas com grampos, aberturas laterais. Fácil de passar Poliéster muito respirável. 100 % poliéster fino



Coffre
Peito

Hanche
Quadril

Longueur
Longo

S

98 - 102 cm
104 - 108 cm
70 - 72 cm

REF.06301/50/1

M

106 - 110 cm
112 - 114 cm
70 - 72 cm

REF.06301/50/2

L

114 - 118 cm
118 - 122 cm
72 - 74 cm

REF.06301/50/3

XL

120 - 124 cm
126 - 130 cm
73 - 75 cm

REF.06301/50/4



Casaque buddha

Casaco buddha

* Não disponível em Portugal

1 u.m.vta
40 box

MOD. 51605109

Casaque à manches japonaises des couleurs vives, col mao, 1 face imprimée attachée avec boutons laqués, 1 poche couleur unie. Dos cintré avec lacets pour ajuster, ouvertures latérales. Repassage facile. Polyester respirant. 100 % polyester.

Casaco de manga japonesa com tom vívido, com clip no peito, colarinho mao, 1 frente estampada com fechos lacados, 1 bolso liso. Voltar com braçadeiras de volta com camadas para cintura regular, aberturas laterais. Fácil de passar Poliéster respirável. 100 % poliéster

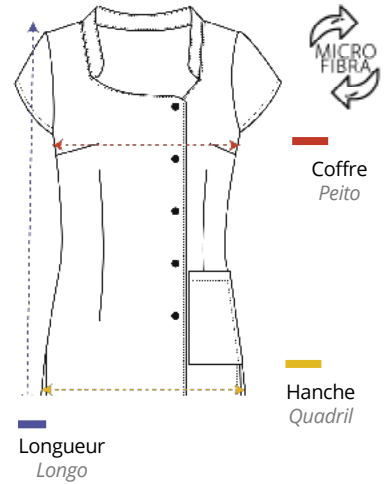

S
94 - 98 cm
102 - 106 cm
71 - 73 cm

REF.06300/50/1

M
94 - 98 cm
102 - 106 cm
71 - 73 cm

REF.06300/50/2

L
106 - 110 cm
116 - 120 cm
75 - 77 cm

REF.06300/50/3

XL
116 - 120 cm
124 - 128 cm
77 - 79 cm

REF.06300/50/4

XXL
118 - 122 cm
130 - 134 cm
75 - 77 cm

REF.06300/50/5

Kimono antistatique

Quimono antiático

MOD. 21300013

Kimono croisé avec ceinture, manche avec mini poche sur la manche. Facile à repasser. Ne déteint pas. 100% polyester marroquin.

Quimono cruzado com cinto, 3/4 de controle com mini bolso na manga. Fácil de passar. 100% poliéster marroquino

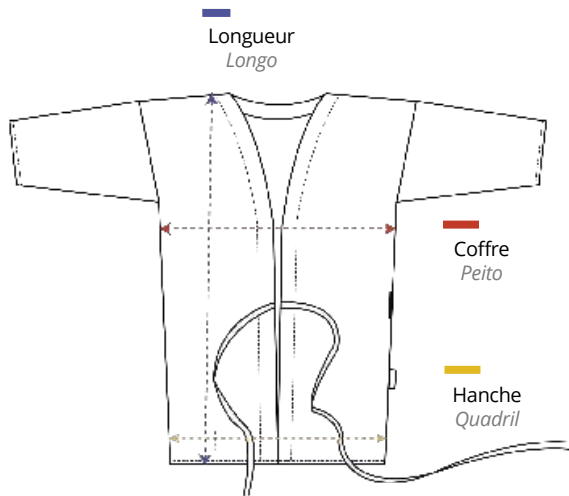

123 cm
123 cm
104 - 106 cm

REF.06302/50

Casaque fermeture éclair
Casaco basic zipper

* Não disponível em Portugal

1 u.m.vta
40 box

MOD. 51308410

Noir
Preta

Casaque sans manches. Fermeture éclair sur le côté. Composition 100% polyester. Deux poches, une à la taille et une sur la poitrine. Recommandée pour les magasins et salons de beauté.

Casaco básico sem mangas. Fecho de correr ao lado. Composição 100% poliéster. Dois bolsos, um na cintura e outro no peito. Recomendado para lojas e centros de beleza.

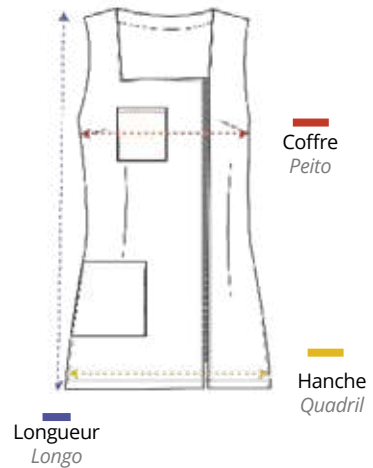

S	M	L	XL	XXL
88 - 92 cm	94 - 98 cm	102 - 106 cm	108 - 112 cm	116 - 120 cm
100 - 104 cm	104 - 108 cm	110 - 114 cm	120 - 124 cm	128 - 132 cm
69 - 71 cm	71 - 73 cm	73 - 75 cm	74 - 76 cm	76 - 78 cm
REF.06298/50/1	REF.06298/50/2	REF.06298/50/3	REF.06298/50/4	REF.06298/50/5

Étole 100% polyester stretch
Estola 100% poliéster stretch

lacla 1 u.m.vta 40 box

MOD. 213014601

Étole 100% Polyester Stretch. Ajustée dans le dos par un noeud. Avec grandes poches avant pratiques.
Estola 100% Poliéster Stretch. Ajustada nas costas com um laço. Com bolsos à frente grandes e cómodos.

UNICA

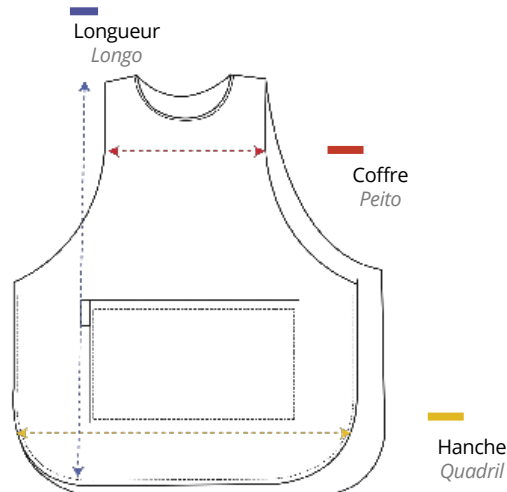

36 cm
51 cm
78 cm

REF.06553/58

Étole collier mao
Estola colarinho mao

1
u.m.vta

40
box

MOD.21602130

Étole Mao, avec crochets métalliques, mini manches, avec et poches, lacets dans le dos pour ajuster à la taille.

Mao roubou, com fechos de metal, mini manga, frente com ourelas e bolsos, ajuste de cintura com fitas que cruzam na parte de trás e amarram na cintura.



100% polyester
100% poliéster

REF.06309/50

100% polyester
100% poliéster

REF.06309/63

100% polyester
100% poliéster

REF.06309/68

50% polyester,50% coton
50 % poliéster, 50% algodão

REF.06309/72

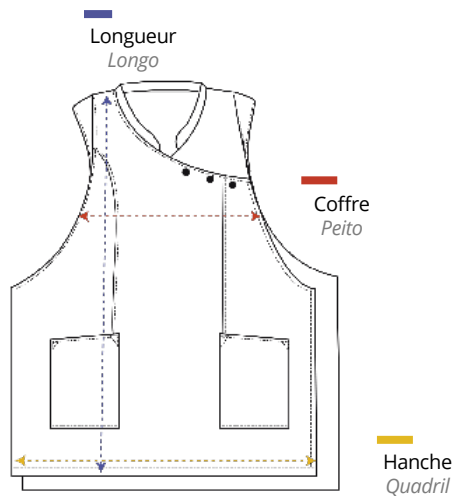

36/37 cm
59/60 cm
75/76 cm

Pantalons femmes
Calças mulher

1
u.m.vta

40
box



MOD. 41300011B

» 60 % polyester
» 33 % coton

» 60% poliéster
» 33% algodão

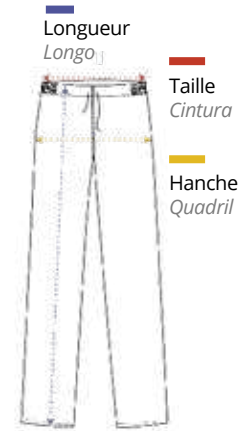

S

92-96 cm
92-96 cm
99-101 cm

REF.06312/58/1

M

98-102 cm
96-100 cm
101-103 cm

REF.06312/58/2

L

106-110 cm
106-110 cm
102-104 cm

REF.06312/58/3

XL

112-116 cm
114-118 cm
105-107 cm

REF.06312/58/4

Distributeur Ayurveda avec pied en bois
Dispensador Ayurveda com pé de madeira

1
u.m.vta

40
box

NEW



REF. 03114

Anneau lumineux à LED D.45 cm avec trépied LED anelar D.45 cm com tripé



REF. 07003

- » Diamètre de lumière anneau à del 18"
- » Poids net de la lumière anneau: 1,07 kg
- » Couleur de la bague: noir
- » Puissance: 50w
- » Tension: ac100 / 240v
- » Alimentation: cordon d'alimentation
- » Quantité de led: 288 perles de led
- » Température de couleur: 2700k / 5700k
- » Couleur led: blanc pur / blanc naturel / blanc chaud / blanc froid
- » 2 Ports usb
- » Pièces: 1 pc de 18" led ring light / 3 pcs de supports de téléphone tuyau / 1 télécommande
- » Obturateur bluetooth / 1 pc de 2,5m. Support de trépied droit / 1 de sac de transport
- » Emballage: ring light séparé emballé ensemble et trépied emballé ensemble

- » *Diamètre de lumière anneau à del 18"*
- » *Poids net de la lumière anneau: 1,07 kg*
- » *Couleur de la bague: noir*
- » *Puissance: 50w*
- » *Tension: ac100 / 240v*
- » *Alimentation: cordon d'alimentation*
- » *Quantité de led: 288 perles de led*
- » *Température de couleur: 2700k / 5700k*
- » *Couleur led: blanc pur / blanc naturel / blanc chaud / blanc froid*
- » *2 Ports usb*
- » *Pièces: 1 pc de 18" led ring light / 3 pcs de supports de téléphone tuyau / 1 télécommande*
- » *Obturateur bluetooth / 1 pc de 2,5m. Support de trépied droit / 1 de sac de transport*
- » *Emballage: ring light séparé emballé ensemble et trépied emballé ensemble*

NEW



Anneau lumineux LED D.26 cm pour bureau avec trépied Anel de luz LED D.26 cm para mesa com tripé



REF. 07293

- » Diamètre de la lumière anneau led. Dix"
- » Poids net léger anneau: 0,24 kg
- » Couleur de la bague: noir
- » Puissance: 8 / 12w
- » Tension: ac85 / 240v
- » Alimentation: alimenté par usb
- » Quantité de led: 120 perles de led
- » Température de couleur: 3000k / 6500k
- » Couleur led: blanc pur / blanc naturel / blanc chaud / blanc froid
- » Pièces: 1 lumière anneau led 10"pc / 1 support de trépied de bureau de 14 cm pc / 1 tuyau pc
- » Support téléphone / 1 pc ball head / 1 pc phone clip / 1 pc remote bluetooth
- » Obturateur / 1 support téléphone réglable / 1 trépied 1,6 pc / 1 sac de transport

- » *Diâmetro de luz anel led. 10"*
- » *Ring light net weight: 0,24 kg*
- » *Cor do anel: preto*
- » *Potência: 8 / 12w*
- » *Tensão: ac85 / 240v*
- » *Fonte de alimentação: usb powered*
- » *Led q'ty: 120 led beads*
- » *Temperatura de cor: 3000k / 6500k*
- » *Cor do led: branco puro / branco natural / branco quente / branco frio*
- » *Peças: 1 pc luz anel led 10" / 1 pc desktop tripé suporte / 1 mangueira pc*
- » *Suporte de telefone / 1 cabeça de esfera de pc / 1 clipe de telefone de pc / 1 bluetooth remoto de pc*
- » *Obturador / 1 porta telefone ajustável pc / 1 pc 1,6 tripé / 1 saco de transporte*

NEW

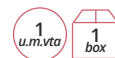

Malette outils**Maleta útil**

- » Matière: cuir synthétique
- » Idéale pour ranger les produits de maquillage et les petits outils.
- » Fermeture: glissière

- » Material: Couro sintético
- » Ideal para armazenar produtos de maquiagem e pequenos utensílios.
- » Encerramento: zíper

- » Noir
- » Preto

NEW**REF. 07320/50**

- » Fuchsia
- » Fúcsia

NEW**REF. 07320/63**

- » Noir
- » Preto

NEW**REF. 07321/50**

- » Fuchsia
- » Fúcsia

NEW**REF. 07321/63**

Valises · Malas

Toutes les valises sont vendues vides
 Todas as malas vendidas vazias



REF.02318



» Pour outils, à l'intérieur transparent et 4 plateau
 » Interior transparente e 4 bandejas



REF.03598



» Pour outils, à l'intérieur se trouve 6 compartiments et 4 plateau
 » Interior 6 compartimentos e 4 bandejas



REF.03599



REF.02317

Valise en aluminium Mala alumínio

» Toutes les valises sont vendues vides
» Todas as malas são vendidas vazias



REF.01492



Valise noire en PVC Mala PVC cor preto

» Toutes les valises sont vendues vides
» Todas as malas são vendidas vazias



REF.02925



Set de 3 valises PVC assorties Conjunto 3 MALAS PVC

» Toutes les valises sont vendues vides
» Todas as malas são vendidas vazias



REF.02594



Valise trolley Trolley

» Avec compartiments et miroir
» Com compartimentos e espelho



REF.03814/68

REF.03814/50



Valise pour maquillage, cosmétique et esthétique Mala de maquiagem, cosméticos e estética



Avec 4 plateaux amovibles et 12 compartiments variables. Grand espace à l'intérieur pour les produits plus grands. Deux serrures et deux clés de rechange incluses.

Com 4 bandejas removíveis e 12 compartimentos variáveis. Com amplo espaço interno para produtos maiores. Inclui duas chaves (abrir / fechar).

Avec des plateaux amovibles (2 de chaque côté), chaque bac dispose de 4 compartiments. Grand espace intérieur classable en 4 sections. Comprend à l'intérieur une bandoulière pour accrocher la valise sur l'épaule. Deux serrures et deux clés de rechange incluses.

Com bandejas removíveis (2 de cada lado), cada bandeja tem 4 compartimentos. Ótimo espaço interior classificável em 4 seções. Inclui no seu interior uma banda para pendurar a mala no ombro e duas chaves (abrir / fechar).



REF.04940/50



REF.04941/50



REF.04940/54



REF.04941/54



REF.04940/70



REF.04941/70

Valise pour maquillage, cosmétique et esthétique

Mala de compartimentos

1
u.m.vta

4
box

Avec plateaux amovibles (2 de chaque côté). Chaque plateau a 4 espaces rangement. Grand espace intérieur avec bandoulière pour le transporter. 2 serrures et 2 clés de rechange incluses.

Com bandejas removíveis (2 de cada lado). Cada bandeja tem 4 compartimentos. Ótimo espaço interior classificável em 4 seções. Inclui uma banda dentro para pendurar a mala no ombro e duas taças com duas chaves de (abrir / fechar).



REF.04942/50



REF.04942/54



REF.04942/70

Valise trolley 4 compartiments**Mala 4 compartimentos**

Toutes les valises sont vendues vides
Todas as malas são vendidas vazias



La valise trolley de Pollié, est créée sur la base d'une structure de 2 corps modifiables, conçue pour faciliter le rangement professionnel de vos ustensiles de coiffure, de maquillage ou de cosmétique.

Le haut de la valise se compose de trois plateaux amovibles. Chacun d'eux est divisé en trois compartiments. Ainsi, dans l'un d'eux, vous trouverez douze espaces circulaires conçus pour stocker les laques à ongles et ainsi empêcher leur détachement, facilitant leur transport en toute sécurité. De plus, l'intérieur du haut du corps peut être modifié selon vos besoins, en variant la structure des compartiments. Enfin, sa fonction 2 en 1 leur permettra d'avoir un sac à main, ou ils préfèrent l'accrocher à l'homme, grâce à sa bande en nylon.

La partie inférieure de la valise a un plateau amovible avec l'option de 4 compartiments qui peuvent également être modifiés grâce aux entretoises. Le bas du corps, avec une grande capacité à l'intérieur, vous donnera la possibilité d'un transport plus léger, car il peut être converti en une valise plus petite, avec un couvercle et un miroir incorporés. Les roues sont interchangeables à l'aide de la languette d'attelage. Le chariot a deux bobines et deux clés de rechange

A mala de carrinho de Pollié é criada com base em uma estrutura de 2 corpos modificáveis, projetados para facilitar o armazenamento profissional de seus utensílios de cabeleireiro, maquiagem ou cosméticos.

A parte superior da mala consiste em três bandejas removíveis. Cada um deles é dividido em três compartimentos. Assim, em um deles, você encontrará doze espaços circulares projetados para armazenar vernizes de unhas e, assim, impedir seu desapego, facilitando o transporte com total segurança. Além disso, o interior da parte superior do corpo pode ser modificado de acordo com suas necessidades, variando a estrutura dos compartimentos. Finalmente, sua função 2-em-1 permitirá que eles tenham uma bolsa, ou eles preferem pendurá-la no homem, graças à sua tira de nylon.

A parte inferior da mala possui uma bandeja removível com a opção de 4 compartimentos que também podem ser modificados graças aos espaçadores. A parte inferior do corpo, com grande capacidade interna, oferece a opção de transporte mais leve, pois pode ser convertida em uma mala menor, com tampa e espelho incorporados. As rodas são intercambiáveis usando a aba do engate.

O carrinho possui duas bobinas e duas chaves (abrir / fechar).



REF.04939/50

REF.04939

Sac porte-outils noir**Bolsa porta-ferramentas cor preto**

REF. 02516



Boîte de rangement accessoires coiffure (vide)**Caixa organizadora (Vazia)**Vides
vazia

REF.04722

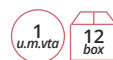
» Aimanté
» Magnetizado

REF.04309

**Pulvérisateur de couleurs transparent****Pulverizador cores transparente**

330 ml



REF.00959



300 ml



REF.01372

» Rond
» Redondo

300 ml



REF.01484



300 ml



REF.01663

porte carte visite aluminium
Porta-cartoes

1
u.m.vta

400
box

REF.02470



Flacon avec pompe de dosage
Frasco dosificador

20
u.m.vta

80
box

240 ml

REF.02880



Protecteur oculaire à lentille UV étui inclus
Protetor ocular UV lente com estojo

10
u.m.vta

100
box

- » Modèle comprenant un nouveau système de fixation spécial basé sur une fourche en fibre plastique transparente
- » Avec étui pour ranger le protecteur

- » Modelo que inclui um novo sistema de fixação especial baseado em um garfo de fibra de plástico transparente
- » Com estojo para guardar o protetor Com fixação especial baseada num gancho de fibra de plástico

- » Comprend une lentille centrale permettant la vision

REF.03195

- » Pas de vision
- » Sem visão



REF.03194

- » Inclui uma lente central que permite visão



Articles en vente exclusive en ESPAGNE
Artigos exclusivo de venda EM ESPANHA

Antiseptique daromix gh Antiséptico daromix gh



500 ml

REF.06200



- » Numéro d'enregistrement AEMPS: 905-DE5
- » Antiseptique hydroalcoolique pour la désinfection hygiénique des mains par friction.
- » Efficacité scientifiquement garantie
- » Biocide à large spectre de 30 sec.
- » Formule hypoallergénique
- » Préserve l'hydratation de la peau
- » N'irrite pas la peau
- » Sèche rapidement
- » Efficace comme: Bactéricide · Levuricide · Virucide · Microbactéricide

- » Número de registo AEMPS: 905-DE5
- » Anti-séptico hidroalcoólico para desinfeção higiénica de mãos por fricção
- » Eficácia cientificamente garantida
- » Biocida de amplo espectro a partir de 30 seg
- » Fórmula hiposensibilizante
- » Preserva a hidratação da pele
- » Não irrita a pele
- » Seca rapidamente
- » Eficaz como: Bactericida · Levuricida · Virucida · Microbactericida

Désinfectant au limoseptol Desinfetante limoseptol



50 ml

REF. 06151



1 L

REF.06150



- » Numéro d'enregistrement AEMPS: 47-DE5
- » Produit de haut niveau développé exclusivement pour l'hygiène, nettoyage et désinfection, pour les ustensiles professionnels de salon de beauté
- » Action détergente - Large spectre
- » Biodégradable - Sans phosphates et sans formol
- » Efficacité germicide et SANITIZER contre: Bactéries, levures et champignons

- » Número de registo AEMPS: 47-DE5
- » Produto de alto nível desenvolvido exclusivamente para higiene, limpeza e desinfeção, para utensílios profissionais de salão de beleza
- » Ação detergente - amplo espectro
- » Biodegradável - sem fosfatos e sem FORMOLO
- » Eficácia germicida e SANITIZER contra:
- » Bactérias, leveduras e fungos.

Bouteille spécial pour gel et solution hydro-alcoolique garrafa especial para gel e solução hidroalcoólica



300 ml

REF.07281



NEW

» Avec support mural
» Com suporte para a parede



300 ml

REF.07280



NEW

Désinfectant de surfaces en spray Higienizante de superfícies em spray



300 ml

REF.07232

Idéal pour la désinfection et le nettoyage de tout type de surfaces:
métallique, plastique, verre et céramique.

» Mobilier, portes, rampes, jouets, toilettes, claviers d'ordinateur,
souris, écrans... Postes de travail

CARACTÉRISTIQUES ET AVANTAGES

- » Inoffensif au contact avec la peau
- » Nettoyage et désinfection rapides et efficaces
- » Évaporation complète, sans laisser de résidu
- » N'attaque pas les plastiques ni les caoutchoucs

Idéal para a higienização e limpeza de qualquer tipo de superfícies:
metálicas, plásticas, vidro e cerâmica.

» Mobiliário, portas, parapeitos, brinquedos, sanitas, teclados de
computador, ratos, ecrãs, postos de trabalho...

» CARACTERÍSTICAS E VANTAGENS

- » Inócuo em contacto com a pele
- » Rápida e efetiva ação de limpeza e higienização
- » Evapora completamente, sem deixar resíduos
- » Não ataca plásticos nem borrachas



NEW

Porte-savon en plastique
Saboneteiro plástico

1
u.m.vta

40
box

REF.02197



Déboucheur à soufflet pour évier et WC
Desatascador w.c

10
u.m.vta

10
box

REF.00931



Manche à balai
Punho vassoura

- » Nettoyage facile et longue durabilité
- » Support plastique
- » Idéal pour tous les types de sols, en particulier le parquet

- » Limpeza fácil e longa durabilidade
- » Suporte de plástico
- » Ideal para todos os tipos de pisos, especialmente parquet



- » Extensible 140 cm
- » Extensível 140 cm

12
u.m.vta

12
box

REF.01131

- » Extra télescopique
- » Telescópico extra



- » Extensible 140 cm
- » Extensível 140 cm

10
u.m.vta

10
box

REF.01365

Balais en caoutchouc Vassouras de borracha

- » Avec languette
- » Com aba

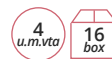

REF.01223



REF. 01285/50



- » Facile à nettoyer et durable, l'efficacité de la conception de ses pointes parvient à faire glisser la poussière sans la soulever, ce qui la rend idéale pour les personnes allergiques car elles favorisent un environnement propre.



REF.02420

- » Fácil de limpar e duradoura, a eficácia do design de seus espigões consegue arrastar o pó sem levantá-lo, tornando-o ideal para quem sofre de alergias, pois favorece um ambiente limpo.



Mobilier

MOBILIÁRIO

Table de massage, tabourets, chaises, supports, chariots, porte-documents et fauteuils de maquillage...

Marquesas, Tambonetes, cadeiras, carrinhos, malas e cadeiras de maquiagem...

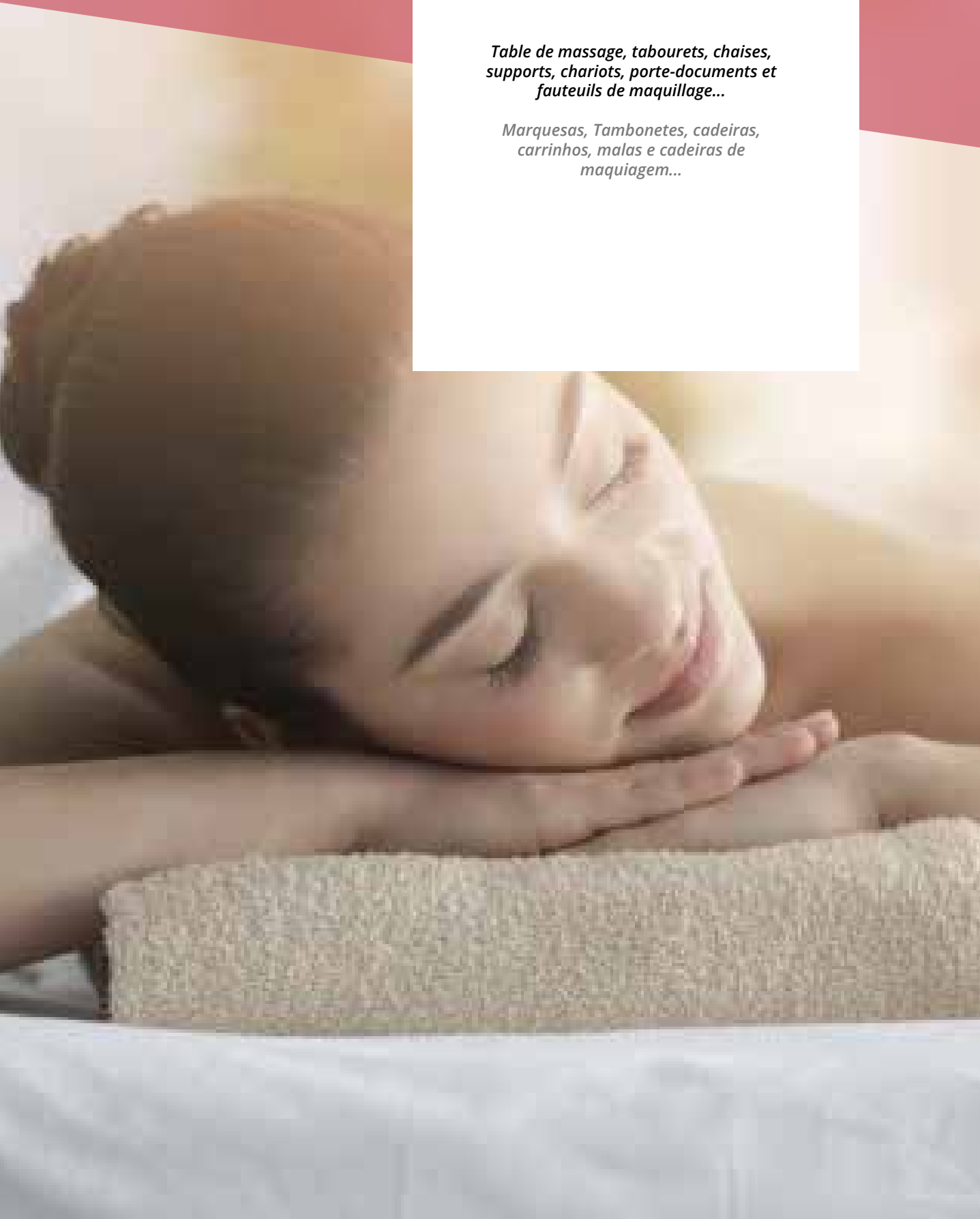

Table de massage pliable portable Marquesa massagem portátil



REF.07384

- » Poid: 17,5 kg
- » Peso: 17,5 kg

NEW

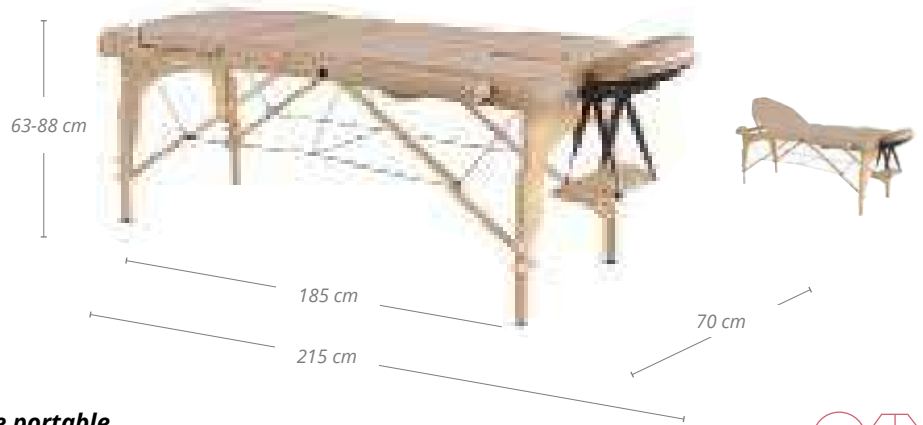

Table de massage pliable portable Marquesa portátil



REF.07385

- » Aluminium
- » Poid: 16 kg

- » Alumínio
- » Peso: 16 kg

NEW



Table de massage pliable portable Marquesa portátil



REF.02737

- » Aluminium
- » Poid: 16 kg

- » Alumínio
- » Peso: 16 kg



Table de massage structure métallique
Marquesa massagem estrutura metálica

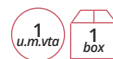

REF.02738

- » Densité de mousse: 30kg/m³
- » Poids: 17 kg

- » Densidade da esponja: 30kg/m³
- » Peso: 17 kg



Table de massage spéciale
Marquesa especial massagem



- » Densité de mousse: 30kg/m³
- » Poids: 31 kg

- » Densidade da esponja: 30kg/m³
- » Peso: 31 kg

REF. 02739

REF. 02739/50

REF. 02739/54

REF. 02739/59



Bras
amovibles
Braços
extraíveis



Dérouleur de papier pour table de massage
Porta rolo papel Marquesa

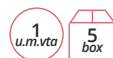

REF.01168

- » Support mural
- » Suporte de parede



Table de massage hydraulique 3 corps Marquesa hidráulica 3 corpos



REF. 03031

- » Densité de mousse: 62kg/m³
- » Avec une cavité faciale (trou) sous le coussin d'appui-tête.
- » Épaisseur PVC 1.1 / 1.2cm
- » Mousse blanche 1^{ère} qualité
- » Confortable, solide et polyvalente.

- » Densidade da esponja: 30kg/m³
- » Braços extraíveis.
- » Com orifício facial por baixo da almofada do repouso-cabeças.
- » Espessura PVC 1.1 / 1.2cm
- » Espuma branca 1^ª qualidade
- » Cómoda, sólida e versátil.



Table de massage électrique 3 corps Marquesa elétrica 3 corpos



REF. 03030

- » Densité de mousse: 30kg/m³
- » Avec le trou facial sous le coussin d'appui-tête.
- » Mousse blanche 1^{ère} qualité.
- » Siège 9,5 cm
- » Confortable, solide et polyvalente.
- » 3 corps - 3 moteurs
- » Supporte 200 Kg.
- » Poids: 70 kg

- » Densidade da esponja: 30kg/m³
- » Com orifício facial sob a almofada do encosto de cabeça.
- » Espuma branca de primeira qualidade.
- » Assento 9,5 cm
- » Cómoda, sólida e versátil.
- » 3 corpos - 3 motores.
- » Suporta 200 Kg
- » Peso: 70 kg



Table de massage spa
Marquesa spa

REF.03032

- » Appuie-tête NON amovible
- » Poids: 53 kg

- » Apoia-cabeças NÃO desmontável
- » Peso: 53 kg

**Marche pied en bois pour spa**
Escada madeira spa

REF.03072

- » Marche en bois pour spa
- » Escada madeira spa

**Set des coussin pour table de massage**
Set almofadas marquesa spa

REF.03069

- » Petit: 40 cm x Ø 11
- » Large: 68 cm x Ø 11
- » Carré: 29 x 40 x 6 cm

- » Pequeno: 40 cm x Ø 11
- » Grande: 68 cm x Ø 11
- » Quadrado: 29 x 40 x 6 cm



Paravent en bois pour spa
*Biombo madeira spa*1
u.m.vta1
box

REF.03078

**Étagère en bois pour spa**
*Estante madeira spa*1
u.m.vta1
box

REF.03071



Table de manucure Mesa manicure

1
u.m.vta

1
box

REF.02139

- » Table de manucure composée d'une planche en bois blanc, d'un pied en aluminium et d'un meuble thermoformé à roulettes
- » Comprend une lampe, tepose-poignet en mousse et un organisateur d'outils pratique
- » Sans aspirateur
- » Poids: 22 kg

- » *Mesa manicure composta de tabuleiro em madeira branco, pé de alumínio e móvel termo-conformado com rodas*
- » *Inclui lâmpada, espuma apoia-mãos e um prático organizador de ferramentas*
- » *Sem aspirador*
- » *Peso: 22 kg*



Table de manucure avec aspiration Mesa manicure com aspiração

1
u.m.vta

1
box

REF.03067

- » Table de manucure composée d'une planche en bois blanc, d'un pied en aluminium et d'un meuble thermoformé à roulettes
- » Comprend une lampe, tepose-poignet en mousse et un organisateur d'outils pratique
- » Avec aspirateur
- » Poids: 22kg

- » *Mesa manicure composta de tabuleiro em madeira branco, pé de alumínio e móvel termo-conformado com rodas*
- » *Inclui lâmpada, espuma apoia-mãos e um prático organizador de ferramentas*
- » *Com aspirador 20W*
- » *Peso: 22kg*



Table de manucure pliante avec aspiration et roues
Mesa manicure articulável com aspiração e rodas



REF.04278

- » Aspirateur 3000 pro
- » Poids: 12 kg
- » 30W

- » Aspirador de 3000 rpro
- » Peso: 12 kg
- » 30W



Table de manucure en bois blanc
Mesa manicure em madeira branca



REF.03934

- » Poids: 33 kg
- » Peso: 33 kg



Chariot d'esthétique POLLIÉ
Carrito estética POLLIÉ



REF. 02839



- » Poids: 22 kg
- » Peso: 22 kg



Lampe pour table manucure Lâmpada mesa manicure



REF.03187

- » Lampe en couleur aluminium
- » Lumière au néon
- » Mesure : 72 cm
- » Fourni avec fluorescent 20W et pièce de rechange supplémentaire.

- » Lâmpada de cor alumínio
- » Luz de néon
- » Medida: 72 cm
- » Fornecida com fluorescente de 20W



Petit chariot manucure Carrinho manicure small

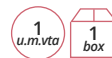

REF.02643/58



REF.02643/50



Chariot manucure / pédicure Carrinho manicure/ pedicure

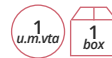

REF.03944/58

REF.03944/50



Comptoir de réception bois et métal à effet miroir
Desk receção de madeira e metal efeito espelho



REF.03935



Canapé d'attente 3 places
Sofá de espera 3 lugares



REF.03950

- » En skai
- » Em pele ecológica



Meuble coiffure de réception en bois de chêne earth
Desk receção carvalho earth

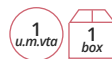

- » Laminé en graphite
- » Avec étagères réglables et 1 tiroir

- » Laminado em grafite
- » Com prateleiras ajustáveis e 1 gaveta



REF.04518/50

REF.04518/65

REF.04518/58

REF.04518/72

Tabouret STREET
Tambonete STREET

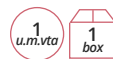

Tabouret STREET classique avec pompe hydraulique pour ajuster la hauteur désirée dans chaque travail.
 Tambonete STREET clássico com bomba hidráulica para regular a altura conforme desejado em cada trabalho.



REF.06103/50

45-59 cm



REF.06103/58

45 cm

Comparatif 04419 - 06103
Comparativo 04419 - 06103



Tabouret base en métal
Tambonete base metal



REF.04419/50

50-66 cm



REF.04419/58

Tabouret mod. SWEET SIT
Tambonete mod. SWEET SIT



REF.01328

61-71 cm



Tabouret mod. RODEO
Tambonete mod. RODEIO



REF.01964

58-77 cm



Tabouret URBAN
Tambonete URBAN

Tabouret ergonomique URBAN avec pompe hydraulique pour ajuster la hauteur désirée dans chaque travail. Sa forme s'adapte au corps et par conséquent favorise une meilleure posture et évite le mal de dos après plusieurs heures de travail.

Tambonete URBAN ergonómico com bomba hidráulica para regular a altura conforme desejado em cada trabalho. A sua forma adapta-se ao corpo e como consequência propicia uma melhor postura e evita as dores de costas depois de muitas horas de trabalho.



REF.06102/50



REF.06102/58

50-64 cm

45 cm

Comparatif 04382 - 06102
Comparativo 04382- 06102**Tabouret avec une base en métal**
Tambonete base metal

REF.04382/50



REF.04382/58

58-77 cm

Fauteuil basculant
Cadeira basculante

- » Inclinaison 130° / Hydraulique
- » Largeur du bras au bras: 57 cm
- » Tête de chaise d'Anchua: 19 cm
- » Tête amovible avec une position
- » Dossier 51 x 41 cm
- » Hauteur de la tête: 13 cm
- » Distance entre le dossier et la tête 14 cm
- » Poids: 32,5 kg

- » Reclinável 130° / Hidráulica
- » Largura do braço ao braço: 57 cm
- » Cabeça de cadeira de ancoragem: 19 cm
- » Cabeça removível com uma posição
- » Encosto 51 x 41 cm
- » Altura da cabeça: 13 cm
- » Distância entre o encosto e a cabeça 14 cm
- » Peso: 32,5 kg



REF. 02975/58

54-68,5 cm

51 cm

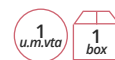
Chaise avec support et système de régulation**Cadeira com encosto e regulação**

REF.02730/50

REF.02730/58

REF.02730/54

Chaise avec support et système de régulation**Cadeira com encosto e regulação**

REF.02732

REF.02732/58

Chaise avec support et système de régulation**Cadeira com encosto e regulação**

REF.03937/50

REF.03937/58

Tabouret FASHION**Cadeira FASHION**

Tabouret FASHION avec dossier pour plus de confort et de soutien au dos. Les roues sont conçues pour éviter que les cheveux ne s'y coincent. Ils sont faciles à nettoyer.

Cadeira FASHION com encosto para mais comodidade e apoio de costas. As rodas estão concebidas para evitar que o cabelo fique preso nelas. São fáceis de limpar



REF.06101/58

Support de tatouage Suporte tatuagem



REF.04915

- » Réglable et inclinable.
- » Mousse: 37 x 21 cm

- » Regulável e basculante.
- » Tapete: 37 x 21 cm



Appui-tête Apoio-nucas



REF.03842

- » Mousse: 23 x 6 cm
- » Tapete: 23 x 6 cm



Support de pédicure Suporte pedicure



REF.03627

- » Support de pédicure 20 x 17 cm.
- » Inclinable
- » 1,94 kg

- » Suporte pedicure 20 x 17 cm.
- » Basculante.
- » 1,94 kg



Chaise de massage Cadeira massagem

1
u.m.vta

1
box



REF.02740/50



REF.02740

Chaise spéciale pédicure avec bain de pieds Cadeira especial pedicura com banheira para pés

- » Maintient l'eau chaude avec bulles.
- » Mantém a água quente e faz borbulhas.

1
u.m.vta

1
box

REF. 02741

Fauteuil de pédicure spa Cadeira de pedicura spa

- » Avec dossier réglable
- » Com encosto ajustável

1
u.m.vta

4
box

REF. 07341

NEW



Valise maquillage

Mala/espelho de maquiagem

1 u.m.vta 1 box

Coiffeuse table de maquillage avec 6 lampes pliables et convertibles dans une valise trolley confortable + 2 gobelets pour les pinceaux. Prise européenne

17 kg

Espelho maquiagem com 6 luzes dobrável e convertível numa cómoda maleta trolley

REF.04937/50



Valise maquillage argent

Mala/espelho de maquiagem

17 kg

REF.04937/54



Appuie-tête chaise maquillage
Assento maquiagem dobrável

1 u.m.vta 6 box

REF.06157

» Convient uniquement pour réf. 06156/50 et 06156/54.
 » Apenas adequado para ref. 06156/50 e 06156/54.



Chaise de maquillage pliable
Cadeira dobradel cor preto

1 u.m.vta 1 box

» Idéal pour le maquillage
 » Ideal para maquiagem

17 kg

REF.06156/50

17 kg

REF.06156/54



Comprend la housse de transport
Inclui transporte funda

Crochet à ventouse

Para pendurar

15
u.m.vta

15
box

REF.02904



Rangement serviettes

Organizadores para pendurar toalhas

1
u.m.vta

6
box

REF.04378

65 x 25 x 30 cm



Conteneur de serviettes

Contentor toalhas

1
u.m.vta

4
box

REF.03159

» Avec des roues Housse conteneur lavable La structure est en acier inoxydable

- » Com rodas
- » Bolsa contentora lavável
- » Estrutura de aço inoxidável
- » Stainless steel structure.







A

ACADÉMIE SPÉCIALE CISEAUX	330
ACCESSOIRES / HYGIÈNE	363 - 366
ACCESSOIRES D'HYGIÈNE / HYDRO - GEL	360 - 364
ALCOOLIQUE	
ACCESSOIRES DE MANUCURE	659 - 663
ACCESSOIRES TEINTE	51 - 52
ACCESSOIRES WAX KG	566 - 567
ACCESSOIRES WAX ROLL - ON	571 - 579
ADHÉSIF POUR FIXER LES COSTINES CHEVEUX	340
ADOUCISSEUR DE GARNITURES	667
AFFICHAGES BROSSES	230 - 231
AGRAFES	156 - 158
ANNEAUX EN ALUMINIUM	338
ANTI-CELLULITE ET FERMÉTÉ	551
ANTICAIDATASSEL	470 - 472
ARC REMBOURRÉ	311 - 315
ARÔMES CHAMOU NEUTROS	128
ART DES ONGLES	603 - 611
ASPIRATEUR CHEVEUX	48 - 49

B

BAGAGES	344 - 351
BANDES MÉCHÉES	53 - 54
BARBIER CAPE LACLA	498
BERGMANN	178
BIGUDIES	289 - 292
BOÎTES DE FOURCHE EUROSTIL	148 - 149
BOÎTES DE SERRAGE EN PLASTIQUE	153 - 156
BOUTELLES D'APPLICATEUR GRADUÉES	67
BROSSE À DÉMÊLER	227 - 229
BROSSE A SOUFFLET AVEC MANCHE EN BOIS	213 - 216
BROSSE À SOUFFLET POIGNÉE EN CAOUTCHOUC	224 - 225
BROSSE CIRCULAIRE	209 - 212
BROSSE CURLING	238
BROSSE DE MASSAGE	278
BROSSE DÉTACHANTE EN PLASTIQUE	237
BROSSE PNEUMATIQUE	226
BROSSE THERMIQUE	242 - 245
BROSSE THERMIQUE EN CÉRAMIQUE - IONIQUE	241
BROSSES	689 - 695
BROSSES	675 - 678
BROSSES A SOUFFLET AVEC MANCHE EN PLASTIQUE	218 - 223
BROSSES BARBER LINE	431 - 433
BROSSES BÉBÉ	239
BROSSES DE BARBIER	427 - 428
BROSSES EUROSTIL	434 - 435
BROSSES NETTOYANTES	445
BROSSES SQUELETTE	232 - 236

C

CAPES BARBER LINE	493 - 495
CAPES DE BARBIER LACLA	498
CAPILLAIRE HYALURONIQUE	122
CAPITAINE COOK COMBS	443
CAPTAIN COOK POUDDRE VOLUMISANTE	454
CASQUETTES	304 - - 309
CHAISES DE BARBIER POUR ENFANTS	483 - 484
CHAISES DE COIFFURE	194 - 199
CHAISES DE COIFFURE POUR ENFANTS	183 - 184
CHARIOTS	201 - 204
CHARIOTS ET TAMBOUR	486
CILS ANDREA	707 - 711
CILS POLLIE	701 - 706
CISEAUX BARBER LINE	421
CISEAUX CAPITAINE COOK	418 - 420
CISEAUX D'INITIATION	424
CISEAUX DE COIFFURE	317 - 329
CISEAUX EUROSTIL	422 - 423
CISEAUX RAGNAR	416 - 417
CISEAUX SPÉCIAUX À MAIN GAUCHE	425
CIVIÈRES	757 - 760
CLIPS AVEC PERLES	164 - 165
CLIPS EUROSTIL	140 - 142

COCKTAILS ET COMPTEURS

COCKTAILS ET COMPTEURS	66
COLORANT CAPILLAIRE	107 - 117
COMBBERS	73 - 74
COMPTOIR DE RÉCEPTION	765
COMPTOIRS ET MIROIRS	181 - 182
COTON	343
COUCHES	78
COUCHES DE COUPE	81 - 85
COUCHES DE COUPE CAPTAIN COOK	497
COUCHES DE COUPE ET DE TEINTE	79 - 80
COUCHES ENFANTS	90 - 91
COUCHES UNE UTILISATION	75 - 77
COULEURS FANTASTIQUES	116
COUPE-CHEVEUX ET COUTEAUX	333 - 335
COUTEAUX CAPITAINE COOK	405 - 406
COUTEAUX DE POCHE BARBER LINE	402 - 404
COUTEAUX DE POCHE EUROSTIL	407
COUTEAUX JETABLES	412
COUTEAUX PLUMES ET SES LAMES	408
COUTEAUX RAGNAR	399 - 400
COUVERTURES ET PAPIER CAMILLA	715 - 716
COUVERTURES JAPONAISES ET DE LAVAGE	65
CRÈME ET GOMMAGE POUR LES PIEDS	667
CRÈMES ET TRAITEMENTS	531 - 541
CRÈMES ET TRAITEMENTS	550 - 552
CRÈMES FACIALES	532 - 537
CRÈMES HYALURONIQUES	531

D

DECOCREAM	119
DÉCOLLEUR DE JOINT	598 - 600
DÉCOLORATIONS	118 - 119
DES BALLES	56 - 59
DES CRAYONS	679 - 682
DES GANTS	71 - 72
DIFFUSEURS	22 - 23
DISTRIBUTEUR 100 COMBES USAGE UNIQUE	256
DISTRIBUTEURS DE GEL	364
DIVERS / LAVEUSES	205
DIVERS MEUBLES	773

E

EAU MICELLAIRE	530
ÉLASTIQUES	159 - 162
ÉMAIL POLLIE	587 - 593
ÉMAIL SEMI-PERMANENT P-LACK	595 - 596
ÉPONGES DE MAQUILLAGE	684 - 688
ÉPONGES KONJAC	545
ESCOVAS	365
ÉTUI À OUTILS CAPTAIN COOK	512
ÉTUI CISEAUX	331 - 333
EXPOSANT BEARD CAPTAIN COOK	456
EXPOSANT ESMALT	587

F

FACEPRO	354
FAUTEUIL DE BARBIER	476 - 480
FERS	29 - 38
FIBRES CAPILLAIRES	134
FICHIERS ET BLOCS DE POLISSAGE	631 - 647
FORMAT DE CIRE KG	557 - 561
FORMAT DE CIRE ROLL-ON	568 - 570
FOURCHES	145 - 147
FOURCHES ET CLIPS	143 - 144
FUSIBLES À CIRE	562 - 565

G

GEL ACRYLIQUE	597
GOMMAGE CORPOREL	550
GRANDES CLIPS D'EXTENSION	339 - 340

H

HUILES DE BASE	547 - 549
HUILES DE MACHINE	388

HUILES ESSENTIELLES	538-539	PIÈCES DE RECHANGE TOURS	622 - 628
I		PINCEAU CREPAR	208
IONI - K	120 - 121	PINCEAUX GEL ET ACRYLIQUE	601 - 602
IONI K 130-131	120-121	PINCES À CURLER	39 - 44
		PINCES COUPE-CUTICULES	650 - 656
L		PINCES DÉPILAIRES	580 - 585
LACLA	92-105	PINCES MÉTALLIQUES	150 - 152
LAIT DÉMAQUILLANT	529	POLO BARBIER	475
LAMES	409 - 411	POMMADE FIXE CAPTAIN COOK	450 - 453
LAMES LAMES RAGNAR	409	PORT UTILE	352- 353
LAQUES	136-137	PORTE-SÈCHEUSE	356
LE RASAGE CO.	457 - 460	PRODUITS DE FINITION	129 - 137
LES LAMPES	612 - 617	PROTECTEURS	70
LES LÉGENDES	469	PROTECTEURS DE COU	491 - 492
LES SERVIETTES	359	PULVÉRISATEUR DE BARBIER	502 - 505
LIGNE ARGAN	125	PULVÉRISATEURS	503
LIGNE DE BROSSES DE RECYCLAGE	286-287	PULVÉRISATEURS	357 - 358
LIGNE DE SOINS DU CORPS	547 - 555		
LIGNE DE SOINS DU VISAGE	529 - 545	R	
LIGNE TALCO BARBER	429	RACINES RETOCA	133
LOUPES	629 - 630	RASOIR DE STYLO, MOUSSES ET GELS	413
LUMIÈRE LED	743	RÉSEAUX	302 - 303
		RIDEAUX DE CHEVEUX NATURELS	337
M		ROBES, KIMONOS ET TABLIERS	88 - 89
M. FAMILLE OURS	461 - 462	RÔLE PERMANENT	168 - 169
MACHINE À LAVER	188 - 193	ROLL - ON WAX MAN	473
MACHINE À RASER CAPTAIN COOK CLASSIC	401	RONDELLE PORTABLE	200 - 201
MACHINE À RASER CLASSIC BARBER LINE	401		
MACHINES DE COUPE BARBER LINE	374	S	
MACHINES DE COUPE RAGNAR	371 - 373	SACS ET CHAISES DE MAQUILLAGE	771 - 772
MACHINES DE DÉCOUPE CAPTAIN COOK	375	SÉCHOIRS	9 - 21
MACHINES DE DÉCOUPE DE RETOUCHE EUROSTI	376	SÉCHOIRS CASCO	24 - 28
MALLETTE À OUTILS	744	SÉPARATEURS DE CHEVEUX	492
MANNEQUIN TÊTES HOMME BERGMAN	521 - 522	SERVIETTES CELLULOSE / SPUNLACE	508
MASCARA	683	SERVIETTES ET FEUILLES	718 - 721
MASQUE CHEVEUX	128	SET DE PEIGNES PROFESSIONNELS	261 - 262
MASQUE COULEUR BRILLANTE	127	SET DE TONDEUSE ET MANUCURE	657 - 658
MASQUE NOIR	530	SHAMPOOING	122 - 127
MASQUES	735 - 736	SHAMPOOING À BARBE CAPTAIN COOK	455
MÉLANGEUR DE TEINTE RECHARGEABLE	45	SHAMPOOING CAPTAIN COOK	447 - 448
MEUBLES SPA LINE	761	SHAMPOOING SEC	122
MIROIRS	729 - 734	SOURCILS ANDREA	713
MIROIRS	485	SPÉCIFIQUE À LA PÉDICURE	664 - 673
MYRSOL	464 - 468	SPRAYS DE BARBIER	502
		STÉRILISATEURS	648 - 649
N		T	
NETTOYANT SILICONE	698	TABLES AUXILIAIRES	202
NIVEAUX DE PEIGNE	240	TABLES DE MANUCURE	762 - 763
		TABLIER BARBER LINE	496
O		TABLIER DE BARBIER LACLA	500 - 501
OSMA	463	TABOURETS / CHAISES	766 - 770
OXYDANT CHEVEUX	114 - 115	TABOURETS / REPOSE PIEDS	185 - 186
		TAPIS DE MACHINE	389
P		TEINTE DE COULEUR BRILLANTE	107-112
PALETINES TEINTÉES	60 - 64	TÊTES DE MANNEQUIN BERGMAN	178
PANIER MANUCURE	764	TÊTES DE MANNEQUIN CHEVEUX NATURELS	171 - 175
PAPIER ALUMINIUM	68 - 69	TÊTES DE MANNEQUIN CHEVEUX SYNTHÉTIQUES	176 - 177
PAPIER DE COU	491	TIMERS	55
PAPILLOTS	293	TONIQUE NETTOYANT	529
PARAFFINE	618 - 619	TOURS	620 - 621
PATIN À ROULETTES	294 - 301	TRAITEMENT DE VENTE À FROID	554
PEIGNE À BARBE - MUSTACHE BARBER LINE	441	TRAITEMENT EFFET WOW	129
PEIGNE À BEADER	246 - 248	TURBANTS	163
PEIGNE À PERLES MECHAS	253		
PEIGNE CARBONE	258 - 259	U	
PEIGNE DE CHOC	251 - 252	USAGE UNIQUE	724 - 727
PEIGNE EN MATÉRIAU RECYCLÉ	437-439		
PEIGNE ESCAPER	270 - 271	V	
PEIGNE SILKOMB	444	VALISES DE BARBIER	506 - 507
PEIGNE SPÉCIALE PUA	249 - 250	VAPEUR ET ACCESSOIRES	543 - 545
PEIGNES À COQUE EN ACÉTATE	283 - 285	VESTIAIRE	737 - 742
PEIGNES PROFESSIONNELLES EUROSTIL	254	VESTIAIRE	178
PEIGNES RAGNAR	440	VOUS PENSEZ RAGNAR	437 - 440
PEUCOS	363		

INDEX · ÍNDICE

A			
ACESSÓRIOS / HIGIENE	363 - 366	CLIPES EUROSTIL	140 - 142
ACESSÓRIOS DE HIGIENE / HIDRO - GEL ALCOÓLICO	360 - 364	CLIPPER DE PREGOS E CONJUNTO DE MANICURE	657 - 658
ACESSÓRIOS DE MANICURE	659 - 663	COCKTAILS E MEDIDORES	66
ACESSÓRIOS ROLO DE CERA - LIGADO	571 - 579	COMBBERS	73 - 74
ACESSÓRIOS TINT	51 - 52	CONJUNTO DE PENTES PROFISSIONAIS	261 - 262
ACESSÓRIOS WAX KG	566 - 567	CONTADORES E ESPELHOS	181 - 182
ACETATE SHELL COMBS	283 - 285	CORES FANTASIA	116
ADESIVO PARA FIXAR OS COSTINOS DE CABELO	340	CORTADOR DE CABELO E FACAS	333 - 335
ÁGUA MICELAR	530	CORTINAS DE CABELO NATURAIS	337
ALGODÃO	343	CREMES E TRATAMENTOS	531 - 541
ALICATE DE CORTADOR	650 - 656	CREMES E TRATAMENTOS	550 - 552
ALICATES DE CURLING	39 - 44	CREMES FACIAIS	532-537
AMACIADOR DE TRIMS	667		
ANDREA EYELASHES	707 - 711	D	
ANÉIS DE ALUMÍNIO	338	DECOCREAM	119
ANTICAIDATASSEL	470 - 472	DEPILAR FORCEPS	580 - 585
ANTICELULITE E FIRMANTE	551	DESCOLORAÇÕES	118-119
ARCO ACOLCHOADO	311 - 315	DIFUSORES	22 - 23
ARGAN LINE	125	DISPENSADORES DE GEL	364
ARQUIVOS E BLOCOS DE POLIMENTO	631 - 647	DISPENSER 100 PENTES DE USO ÚNICO	256
ARTE DE UNHA	603 - 611	DISPLAYS DE ESCOVA	230 - 231
AS LENDAS	469		
AVENTAL BARBER LINE	496	E	
AVENTAL DE BARBEIRO LACLA	500 - 501	ELÁSTICOS	159 - 162
		ESCAPER COMB	270 - 271
B		ESCOVA CIRCULAR	209 - 212
BAGAGEM	344 - 351	ESCOVA CREPAR	208
BALCÃO DE RECEPÇÃO	765	ESCOVA CURLING	238
BANCADAS / CADEIRAS	766 - 770	ESCOVA DE FOLHAS COM CABO DE MADEIRA	213 - 216
BANCADAS / PÉS	185 - 186	ESCOVA DE MASSAGEM	278
BARBER ARMCHAIR	476 - 480	ESCOVA DE REMOÇÃO DE PLÁSTICO	237
BARBER CAPE LACLA	498	ESCOVA DETANQUE	227 - 229
BARBER LINE CAPES	493 - 495	ESCOVA PNEUMÁTICA	226
BARBER LINE SCISSORS	421	ESCOVA TÉRMICA	242 - 245
BARBER POLO	475	ESCOVA TÉRMICA CERÂMICA - IÔNICA	241
BARBER SPRAYER	502 - 505	ESCOVAR PENTES LIMPOS	445
BARBER SPRAYS	502	ESCOVAS	365
BARBER SUITCASES	506 - 507	ESCOVAS	689 - 695
BEADER COMB	246 - 248	ESCOVAS	675 - 678
BERGMAN MANNEQUIN HEADS	178	ESCOVAS BARBER LINE	431 - 433
BERGMANN	178	ESCOVAS DE BARBEIRO	427 - 428
BIGUDIES	289 - 292	ESCOVAS DE BEBÊ	239
BLADES	409 - 411	ESCOVAS DE ESQUELETO	232 - 236
BOLAS	56 - 59	ESCOVAS DE FOLHA COM CABO DE PLÁSTICO	218 - 223
BRIGHT COLOR MASK	127	ESCOVAS DE GEL E ACRÍLICO	601 - 602
		ESCOVAS EUROSTIL	434 - 435
		ESFREGA DE CREME E PÉS	667
C		ESFREGA DO CORPO	550
CABEÇA DE MANEQUIM CABELO NATURAL	171 - 175	ESMALT EXHIBITOR	587
CABEÇA DE MANEQUIM CABELO SINTÉTICO	176 - 177	ESPECIAL PUA COMB	249 - 250
CADEIRAS DE CABELEIREIRO	194 - 199	ESPECÍFICO DE PEDICURA	664 - 673
CADEIRAS DE CABELEIREIRO INFANTIL	183 - 184	ESPELHOS	729 - 734
CAIXAS DE BRAÇADEIRA DE PLÁSTICO	153 - 156	ESPELHOS	485
CAMADAS	78	ESPONJAS DE MAQUIAGEM	684 - 688
CAMADAS DE CORTE	81 - 85	ESPONJAS KONJAC	545
CAMADAS DE CORTE E TINTURA	79 - 80	ESTERILIZADORES	648 - 649
CAMADAS DE CRIANÇA	90 - 91	ESTOJO DA TESOURA	331 - 333
CAPAS E PAPEL CAMILLA	715 - 716	EUROSTIL FORK BOXES	148 - 149
CAPAS JAPONESAS E DE LAVAGEM	65	EUROSTIL PROFESSIONAL COMBS	254
CAPILAR HIALURÔNICO	122	EXPOSITOR DO CAPITÃO COZINHEIRO DE BARBA	456
CAPITÃO COOK BEARD SHAMPOO	455		
CAPITÃO COOK SHAMPOO	447 - 448	F	
CÁPSULAS	304 - 309	FACAS CAPTAIN COOK	405 - 406
CAPTAIN COOK CLASSIC BARBEAR	401	FACAS DE BOLSO BARBER LINE	402 - 404
CAPTAIN COOK COMBS	443	FACAS DE BOLSO EUROSTIL	407
CAPTAIN COOK CUTTING LAYERS	497	FACAS DE PENNA E SUAS LÂMINAS	408
CAPTAIN COOK TOOLS CASE	512	FACAS DESCARTÁVEIS	412
CAPTAIN COOK VOLUMIZING POWDER	454	FACAS RAGNAR	399 - 400
CARRINHO DE MANICURE	764	FACEPRO	354
CARRINHOS	201 - 204	FERROS	29 - 38
CARRINHOS E TAMBOR	486	FIBRAS CAPILARES	134
CELULOSE / TOALHAS SPUNLACE	508	FORMATO DE CERA ROLL-ON	568 - 570
CHAMOU NEUTROS AROMAS	128	FORQUILHAS	145 - 147
CHILDREN BARBER CHAIRS	483 - 484	FORQUILHAS E CLIPAS	143 - 144
CLIPES COM PÉROLAS	164 - 165	FRASCOS DE APLICADOR GRADUADOS	67

INDEX · ÍNDICE

FUSORES DE CERA	562 - 565	PENTE DE CHOQUE	251 - 252
G		PENTE DE MATERIAL RECICLADO	437-439
GEL ACRÍLICO	597	PEUCOS	363
GRANDES CLIPES DE EXTENSÃO	339 - 340	POLLIE ENAMEL	587 - 593
H		POLLIE EYELASHES	701 - 706
HAIR VACUUM CLEANER	48 - 49	POMADA DE FIXAÇÃO DO CAPITÃO COOK	450 - 453
HYALURONIC CREAMS	531	PORTA ÚTIL	352-353
I		PRODUTOS DE ACABAMENTO	129 - 137
IONI - K	120 - 121	PROTETORES	70
IONI K 130-131	120-121	PROTETORES DE PESCOÇO	491 - 492
L		PULVERIZADORES	357 - 358
LACLA	92-105	PUNHOS DE ESCOVA DE BORRACHA	224 - 225
LACLA BARBER CAPES	498	R	
LACQUERS	136-137	RAGNAR COMBS	440
LÂMINAS LÂMINAS DE RAGNAR	409	REDES	302 - 303
LÂMPADAS	612 - 617	RETOCA ROOTS	133
LÁPIS	679 - 682	ROBES, QUIMONOS E AVENTAIS	88 - 89
LATHES	620 - 621	ROLL - ON WAX MAN	473
LAVADORA PORTÁTIL	200 - 201	ROLOS	294 - 301
LEITE DE LIMPEZA	529	S	
LINHA DE CUIDADOS DO CORPO	547 - 555	SACOS E CADEIRAS DE MAQUILHAGEM	771 - 772
LINHA DE CUIDADOS FACIAIS	529 - 545	SEAL REMOVER	598 - 600
LINHA DE ESCOVA DE RECICLAGEM	286-287	SECADORES	9 - 21
LOUPES	629 - 630	SECADORES DE CASCO	24 - 28
LUVAS	71 - 72	SECO SHAMPOO	122
LUZ LED	743	SENHOR. BEAR FAMILY	461 - 462
M		SEPARADORES DE CABELO	492
MACAS	757 - 760	SILICONE CLEANER	698
MACHINE MATS	389	SILKOMB COMB	444
MANNEQUIN HEADS MAN BERGMAN	521 - 522	SOBRANCELHAS ANDREA	713
MÁQUINA DE BARBEAR LINHA DE BARBEIRO CLÁSSICA	401	SPRAYERS	503
MÁQUINA DE LAVAR	188 - 193	STAPLES	156 - 158
MÁQUINAS DE CORTE CAPTAIN COOK	375	STRIPS WICKED	53 - 54
MÁQUINAS DE CORTE DE TOQUE EUROSTI	376	SUPORTE DE SECADOR	356
MÁQUINAS DE CORTE PARA LINHA DE BARBEIRO	374	T	
MÁQUINAS DE CORTE RAGNAR	371 - 373	TABELAS AUXILIARES	202
MÁSCARA DE CABELO	128	TALCO BARBER LINE	429
MÁSCARA DE PLATAFORMA	683	TEMPORIZADORES	55
MÁSCARA PRETA	530	TESOURA ACADEMIA ESPECIAL	330
MASCARAS	735 - 736	TESOURA DE CABELEIREIRO	317 - 329
MATIZ DE COR BRILHANTE	107-112	TESOURA DE RAGNAR	416 - 417
MECHAS BEADING COMB	253	TESOURA DO CAPITÃO COZINHEIRO	418 - 420
MESAS DE MANICURA	762 - 763	TESOURA EUROSTIL	422 - 423
MISTURADOR DE TINTURA RECARREGÁVEL	45	TESOURAS DE INICIAÇÃO	424
MÓVEIS DA LINHA SPA	761	TESOURAS ESPECIAIS PARA A MÃO ESQUERDA	425
MYRSOL	464 - 468	THE SHAVING CO.	457 - 460
N		TINTURA CAPILAR	107 - 117
NÍVEIS DE PENTE	240	TOALHAS	359
O		TOALHAS E FOLHAS	718 - 721
ÓLEOS DE BASE	547 - 549	TÔNICA DE LIMPEZA	529
ÓLEOS DE MÁQUINA	388	TRATAMENTO DE VENDA FRIA	554
ÓLEOS ESSENCIAIS	538-539	TRATAMENTO DO EFEITO WOW	129
OSMA	463	TURBANTES	163
OXIDANTE DE CABELO	114 - 115	TWEEZERS METÁLICOS	150 - 152
P		U	
P-LACK SEMI-PERMANENTE DE ESMALTE	595 - 596	USO DAS CAMADAS UM	75 - 77
PALETINAS DE MATIZ	60 - 64	USO ÚNICO	724 - 727
PAPEL ALUMÍNIO	68 - 69	V	
PAPEL DE PESCOÇO	491	VAPORES E ACESSÓRIOS	543 - 545
PAPEL PERMANENTE	168 - 169	VÁRIOS / LAVADORES	205
PAPILHAS	293	VÁRIOS MÓVEIS	773
PARAFINA	618 - 619	VESTIÁRIO	737 - 742
PASTA DE FERRAMENTAS	744	VESTIÁRIO	178
PEÇAS SOBRESSALENTES LATHES	622 - 628	VOCÊ ACHA RAGNAR	437 - 440
PEN RAZOR, ESPUMA E GEL	413	W	
PENTE DE BARBA - BIGODE DA LINHA DE BARBEIRO	441	WAX FORMAT KG	557 - 561
PENTE DE CARBONO	258 - 259	X	
		XAMPU	122 - 127

CATÁLOGUE / CATÁLOGO

2021

*Distributeur agréé:
Distribuidor oficial de:*

Eurostil, Pollié, Tassel, Barber Line, Ragnar, Dousse, Myrsol, Captain Cook, Panasonic, Vasso, Elios, Derby, Derby Premium, Persona, Supermax, Bic, Mr.Bear Family, Feather, Medisana, Maniquick, Promed, Clipp-aid, Facepro, Piccolo, Famex, Ceriotti, Espabite, Ringlets, Pegasus, Matador, Osma, Andrea, Bergmann, Lacla, The Legends, Daromix, Limoseptol, Ondina, Sabrina, Beautene, Tessitaglio



www.eurostil.com



*C/Ciudad de Asunción 56 · Barcelona 08030 (Spain)
Tel. +34 93 274 07 84 · Fax. +34 93 311 89 56
ventas@eurostil.com · export@eurostil.com*

CATÁLOGO 2021 PORTUGUES / FRANCÉS



8423029079987